

# KAWAI

# ANYTIME X

## Owner's Manual

PART NAMES  
& FUNCTIONS  
1

BASIC  
OPERATION  
2

INTERNAL  
SOUNDS  
3

METRONOME  
4

RECORDER  
5

DEMO MODE  
6

MENU  
FUNCTIONS  
7

USB USAGE  
8

APPENDIX  
9



## Thank you for purchasing a KAWAI AnyTimeX piano!

The AnyTimeX piano is a revolutionary new instrument that combines the capabilities of an acoustic piano and a digital piano. With the AnyTimeX piano, one can enjoy the pleasing, expressive tone of KAWAI acoustic pianos, with the convenience of powerful, exciting features that can only be found on a digital instrument.

As its name implies, the most compelling aspect of the AnyTimeX piano is that it can be played at literally any time, without disturbing family or neighbours. It will allow you to enjoy the touch of a fine KAWAI acoustic piano while retaining the privacy and power of built-in digital sound. The AnyTimeX piano will offer many creative new possibilities for music-making in your home, school, or recording studio.

To get the most from your AnyTimeX piano, please read this manual carefully and become familiar with all its powerful functions and features. We trust that you and your AnyTimeX piano will be making beautiful music together (at any time of the day or night) for many years to come.

## TABLE OF CONTENTS

<b>IMPORTANT SAFETY INSTRUCTIONS .....</b>	<b>4</b>	<b>7. MENU FUNCTIONS .....</b>	<b>24</b>
<b>1. PART NAMES &amp; FUNCTIONS.....</b>	<b>8</b>	◇ MENU FUNCTION LIST.....	24
◇ CONTROL BOX .....	8	0) DUAL BALANCE .....	25
<b>2. BASIC OPERATION.....</b>	<b>10</b>	1) VOICING.....	26
◇ ACTIVATING ANYTIME MODE.....	10	2) DAMPER RESONANCE .....	27
◇ PERFORMING WITH HEADPHONES.....	11	3) STRING RESONANCE .....	28
◇ ABOUT THE SOUNDBOARD SPEAKER .....	11	4) KEY OFF EFFECT .....	30
<b>3. INTERNAL SOUNDS .....</b>	<b>12</b>	5) TOUCH .....	31
1) SINGLE TONE MODE.....	12	6) TEMPERAMENT .....	32
2) DUAL MODE .....	13	7) KEY OF TEMPERAMENT .....	34
3) REVERB.....	14	8) TUNING.....	35
<b>4. METRONOME .....</b>	<b>15</b>	9) STRETCH TUNING .....	36
◇ ACTIVATING THE METRONOME .....	15	10) TRANSPOSE.....	37
◇ ADJUSTING THE METRONOME TEMPO.....	15	11) MIDI CHANNEL.....	38
◇ CHANGING THE METRONOME TIME SIGNATURE ..	16	◇ MIDI OVERVIEW.....	38
◇ ADJUSTING THE METRONOME VOLUME .....	16	12) LOCAL CONTROL .....	41
◇ DEACTIVATING THE METRONOME .....	16	13) FIRST DEMO .....	42
<b>5. RECORDER .....</b>	<b>17</b>	14) DEMO REPEAT.....	43
1) RECORDING A SONG.....	17	15) REVERB TYPE.....	44
2) PLAYING BACK A SONG.....	19	16) METRONOME BEAT .....	45
3) DELETING A SONG.....	20	17) METRONOME VOLUME.....	46
<b>6. DEMO MODE .....</b>	<b>22</b>	18) LOUDNESS.....	47
◇ LIST OF DEMONSTRATION PIECES .....	22	19) DELETE RECORDED SONG .....	48
◇ LISTENING TO DEMONSTRATION PIECES .....	23	20) USER MEMORY.....	49
		21) FACTORY RESET .....	50
		<b>8. USB USAGE .....</b>	<b>51</b>
		◇ ABOUT THE USB CONNECTOR.....	51
		◇ ABOUT THE USB DRIVER .....	51
		◇ NOTES ON USB USAGE.....	52
		<b>9. APPENDIX .....</b>	<b>53</b>
		◇ SPECIFICATIONS .....	53
		◇ MIDI IMPLEMENTATION CHART .....	54
		◇ MAINTENANCE PRECAUTIONS (UPRIGHT PIANO) .....	55
		◇ MAINTENANCE PRECAUTIONS (GRAND PIANO) .....	56

# IMPORTANT SAFETY INSTRUCTIONS

## SAVE THESE INSTRUCTIONS

INSTRUCTIONS PERTAINING TO A RISK OF FIRE, ELECTRIC SHOCK, OR INJURY TO PERSONS



### WARNING

TO REDUCE THE RISK OF FIRE OR ELECTRIC SHOCK, DO NOT EXPOSE THIS PRODUCT TO RAIN OR MOISTURE.

**AVIS : RISQUE DE CHOC ELECTRIQUE - NE PAS OUVRIR.**

TO REDUCE THE RISK OF ELECTRIC SHOCK, DO NOT REMOVE COVER (OR BACK). NO USER-SERVICEABLE PARTS INSIDE. REFER SERVICING TO QUALIFIED SERVICE PERSONNEL.



The lightning flash with arrowhead symbol, within an equilateral triangle, is intended to alert the user to the presence of uninsulated "dangerous voltage" within the product's enclosure that may be of sufficient magnitude to constitute a risk of electric shock to persons.



The exclamation point within an equilateral triangle is intended to alert the user to the presence of important operating and maintenance (servicing) instructions in the literature accompanying the product.

### Examples of Picture Symbols



denotes that care should be taken.  
The example instructs the user to take care not to allow fingers to be trapped.



denotes a prohibited operation.  
The example instructs that disassembly of the product is prohibited.



denotes an operation that should be carried out.  
The example instructs the user to remove the power cord plug from the AC outlet.

### Read all the instructions before using the product.

- 1) Read these instructions.
- 2) Keep these instructions.
- 3) Heed all warnings.
- 4) Follow all instructions.
- 5) Do not use this apparatus near water.
- 6) Clean only with dry cloth.
- 7) Do not block any ventilation openings. Install in accordance with the manufacturer's instructions.
- 8) Do not install near any heat sources such as radiators, heat registers, stoves, or other apparatus (including amplifiers) that produce heat.
- 9) Do not defeat the safety purpose of the polarized or grounding-type plug. A polarized plug has two blades with one wider than the other. A grounding type plug has two blades and a third grounding prong. The wide blade or the third prongs are provided for your safety. If the provided plug does not fit into your outlet, consult an electrician for replacement of the obsolete outlet.
- 10) Protect the power cord from being walked on or pinched particularly at plugs, convenience receptacles, and the point where they exit from the apparatus.
- 11) Only use attachments/accessories specified by the manufacturer.
- 12) Use only with the cart, stand, tripod, bracket, or table specified by the manufacturer, or sold with the apparatus. When a cart is used, use caution when moving the cart/apparatus combination to avoid injury from tip-over. 
- 13) Unplug this apparatus during lightning storms or when unused for long periods of time.
- 14) Refer all servicing to qualified service personnel. Servicing is required when the apparatus has been damaged in any way, such as power-supply cord or plug is damaged, liquid has been spilled or objects have fallen into the apparatus, the apparatus has been exposed to rain or moisture, does not operate normally, or has been dropped.

**WARNING - When using electric products, basic precautions should always be followed, including the following.**



## WARNING

Indicates a potential hazard that could result in death or serious injury if the product is handled incorrectly.

The product should be connected to an AC outlet of the specified voltage.



- If you are going to use an AC power cord, make sure that it has the correct plug shape and conforms to the specified power voltage.
- Failure to do so may result in fire.

Use only the AC adaptor included with this instrument to power the instrument.



- Do not use other AC adaptors to power this instrument.
- Do not use the included AC adaptor or AC power cord to power other equipment.

Do not insert or disconnect the power cord plug with wet hands.



Doing so may cause electric shock.

The chair must be used properly (it must be used only when playing the product).

- Do not play with it or stand on it.
- Only one person is allowed to sit on it.
- Do not sit on it when opening the lid.
- Re-tighten the bolts occasionally.

Doing so may cause the chair to fall over or your fingers to be trapped, resulting in injury.

When using the headphones, do not listen for long periods of time at high volume levels.

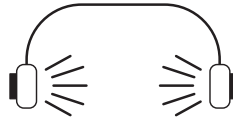

Doing so may result in hearing problems.

Do not lean against the keyboard.

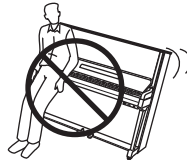

Doing so may cause the product to fall over, resulting in injury.

Do not disassemble, repair or modify the product.

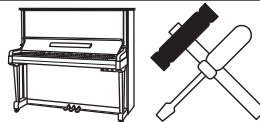

Doing so may result in product breakdown, electric shock or short-circuit.

When disconnecting the AC power cord's plug, always hold the plug and pull it to remove it.



- Pulling the AC power cord itself may damage the cord, causing a fire, electric shock or short-circuit.

The product is not completely disconnected from the power supply even when the power switch is turned off. If the product will not be used for a long time, unplug the AC power cord from the AC outlet.



- Failure to do so may cause fire in case of lightning.
- Failure to do so may over-heat the product, resulting in fire.

This product may be equipped with a polarised line plug (one blade wider than the other). This is a safety feature. If you are unable to insert the plug into the outlet, contact an electrician to replace your obsolete outlet. Do not defeat the safety purpose of the plug.

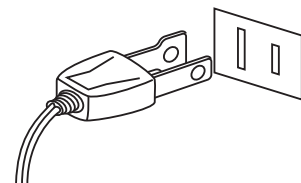

It is a good practice to place the instrument near the AC outlet and to place the power cord plug in a position that allows the plug to be disconnected easily in the event of an emergency. Electricity is always charging while the plug is in the AC outlet even when the power switch is in the 'OFF' position.



# CAUTION

Indicates a potential hazard that could result in injury or damage to the product or other property if the product is handled incorrectly.

**Do not use the product in the following areas.**

- Areas, such as those near windows, where the product is exposed to direct sunlight
- Extremely hot areas, such as near a heater
- Extremely cold areas, such as outside
- Extremely humid areas
- Areas where a large amount of sand or dust is present
- Areas where the product is exposed to excessive vibrations

Using the product in such areas may result in product breakdown. Use the product only in moderate climates (not in tropical climates).

**When closing the fallboard, close it gently.**

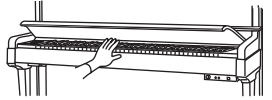

Closing it roughly may trap your fingers, resulting in injury.

**Before connecting cords, make sure that the power to this product and other devices is turned OFF.**

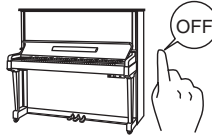

Failure to do so may cause breakdown of this product and other devices.

**Take care not to allow any foreign matter to enter the product.**

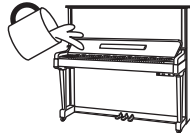

Entry of water, needles or hair pins may result in breakdown or short-circuit. The product should not be exposed to dripping or splashing. No objects filled with liquids, such as vases, should be placed on the product.

**Do not drag the product on the floor. Take care not to drop the product.**

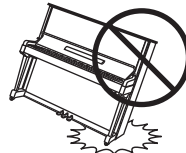

Please lift up the product when moving it. Please note that the product is heavy and must be carried by more than two persons. Dropping the product may result in breakdown.

**Do not place the product near electrical appliances such as TVs and radios.**

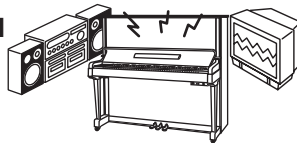

- Doing so may cause the product to generate noise.
- If the product generates noise, move the product sufficiently away from the electrical appliance or connect it to another AC outlet.

**When connecting the AC power cord and other cords, take care not to entangle them.**



Failure to do so may damage them, resulting in fire, electric shock or short-circuit.

**Do not wipe the product with benzene or thinner.**



- Doing so may result in discoloration or deformation of the product.
- When cleaning the product, put a soft cloth in lukewarm water, squeeze it well, then wipe the product.

**Do not stand on the product or exert excessive force.**

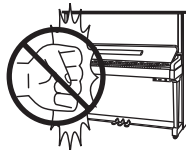

- Doing so may cause the product to become deformed or fall over, resulting in breakdown or injury.

**Do not place naked flame, such as lighted candles on the product.**

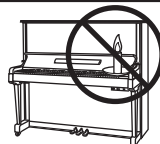

Doing so may cause the illumination to fall over, resulting in fire.

Ensure that the ventilation is not impeded by covering the ventilation openings with items, such as newspaper, table-cloths, curtains, etc.



Failure to do so may over-heat the product, resulting in fire.

The product should be located so that its location or position does not interfere with its proper ventilation. Ensure a minimum distance of 5cm around the product for sufficient ventilation.

The product should be serviced by qualified service personnel when:

- The power supply cord or the plug has been damaged.
- Objects have fallen, or liquid has been spilled into the product.
- The product has been exposed to rain.
- The product does not appear to operate normally or exhibits a marked change in performance.
- The product has been dropped, or the enclosure damaged.

### Notes on Repair

Should an abnormality occur in the product, immediately turn the power OFF, disconnect the power cord plug, and then contact the shop from which the product was purchased.

### CAUTION:

To prevent electric shock, match the wide blade of the plug with the wide socket slot and insert fully.

### ATTENTION:

Pour éviter les chocs électriques, introduire la lame la plus large de la fiche dans la borne correspondante de la prise et pousser jusqu'au fond.

### Instruction for AC power cord (U.K.)

Do not plug either terminal of the power cord to the ground of the AC outlet on the wall.

### FCC Information

This equipment has been tested and found to comply with the limits for a Class B digital device, pursuant to Part 15 of the FCC Rules. These limits are designed to provide reasonable protection against harmful interference in a residential installation. This equipment generates, uses and can radiate radio frequency energy and, if not installed and used in accordance with the instructions, may cause harmful interference to radio communications.

If this equipment does cause harmful interference to radio or television reception, which can be determined by turning the equipment off and on, the user is encouraged to try to correct the interference by one or more of the following measures:

- Reorient or relocate the receiving antenna.
- Increase the separation between the equipment and receiver.
- Connect the equipment into an outlet on a different electrical circuit from the receiver.
- Consult the dealer or an experienced radio/TV technician for help.

### Canadian Radio Interference Regulations

This instrument complies with the limits for a class B digital apparatus, pursuant to the Radio Interference Regulations, C.R.C., c. 1374.

# 1. PART NAMES & FUNCTIONS

This section explains the location and function of the control panel and connectors.

- Control box: panel open

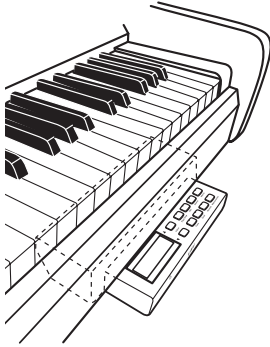

Upright piano

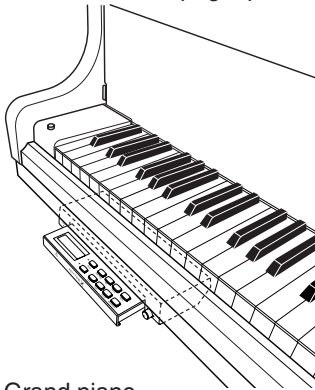

Grand piano

- Control box: panel & headphone hook (front view)

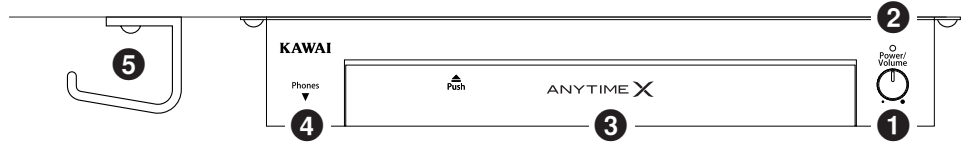

- Control box: panel open (above view)

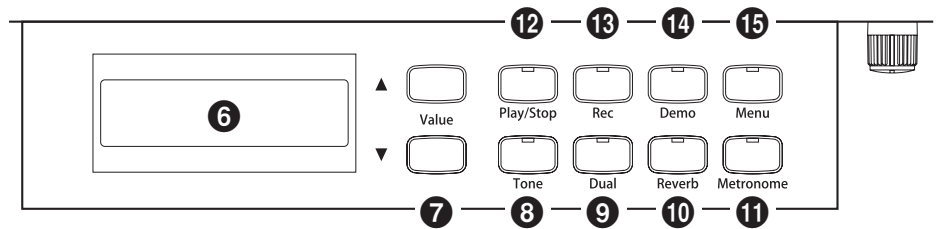

※ Please do not place any objects on top of the control panel.

- Control box: MIDI, USB, LINE IN/OUT connectors (rear view)

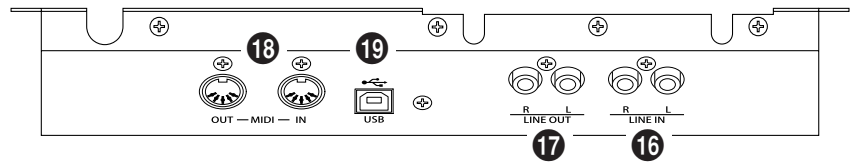

- DC IN connector

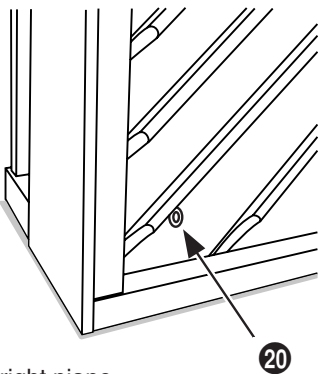

Upright piano

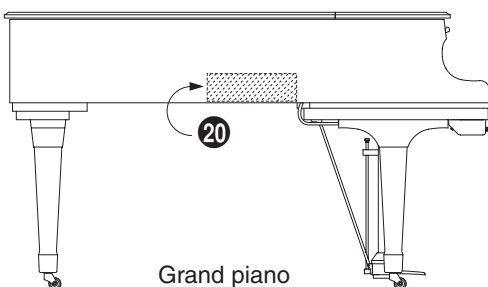

Grand piano

- Pedals & Muting lever

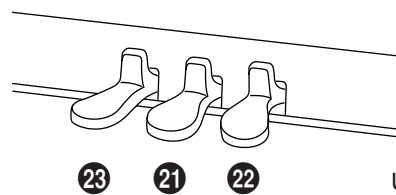

Upright piano

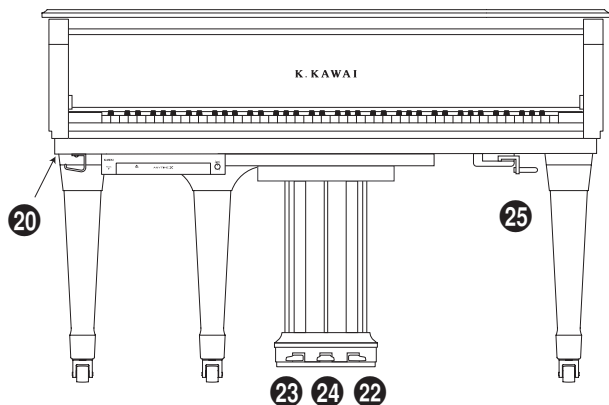

23 24 22



**1 Power / Volume**

Used to turn on/off the control panel and adjust the volume when AnyTime mode is activated. Turn the knob clockwise to turn on the control panel and increase the volume.

**2 Power Indicator**

Used to indicate that the control panel is turned on.

**3 Control Panel**

Used to select various functions when AnyTime mode is activated. Press the area marked 'Push' to reveal the control panel.

**4 Phones**

Used to connect up to two pairs of headphones simultaneously.

**5 Headphone Hook**

Used to conveniently hang the headphones when not in use.

**6 LCD Display**

Used to display information such as the currently selected sound type and settings for other functions.

**7 Value**

Used to change the value for various functions.

**8 Tone**

Used to select the tone when AnyTime mode is activated.

**9 Dual**

Used to layer two tones together when AnyTime mode is activated. (See page 13)

**10 Reverb**

Used to add reverberation to the sound when AnyTime mode is activated, simulating the acoustic environment of a recital room, live stage or concert hall. (See page 14)

**11 Metronome**

Used to activate/deactivate the metronome.

**12 Play/Stop**

Used to start/stop playback of recorded songs.

**13 Rec**

Used to record songs. (See page 17)

**14 Demo**

Used to start/stop playback of demonstration pieces. (See page 22)

**15 Menu**

Used to access menu functions that control advanced features such as tuning. (See page 24)

**16 LINE IN Jacks**

Used to connect the stereo output from other electronic instruments or audio equipment such as a CD player.

**17 LINE OUT Jacks**

Used to connect the AnyTime mode audio signal to an external amplifier, speakers, or recording device such as a computer.

**18 MIDI IN/OUT Connectors**

Used to connect the AnyTimeX piano to external MIDI devices such as other electronic instruments or computers.

**19 USB Connector**

Used to connect the AnyTimeX piano with a personal computer to exchange MIDI data.

**20 DC IN Jack**

Used to connect the AC adaptor.

**21 Mute Pedal (upright piano)**

Used to mute the acoustic piano sound. Depress this pedal and slide it gently to the left to activate AnyTime mode.

Do not attempt to activate/deactivate AnyTime mode while playing the piano as this can cause serious damage to the action mechanism of the instrument.

**22 Damper Pedal**

Used to remove all dampers from the strings, allowing them to vibrate freely. This greatly enriches the piano's sound, while also assisting the pianist to play smooth 'legato' passages.

**23 Soft Pedal / Sostenuto Pedal (upright piano)**

Used to soften the sound, reducing its volume.

When 'Jazz Organ' or 'Drawbar Organ' sounds are selected, the soft pedal is used to alternate the speed of the rotary speaker simulation between 'Slow' and 'Fast' effect modes.

With upright ATX instruments, it is also possible to use the Soft pedal as a Sostenuto pedal by depressing the pedal while turning on the AnyTimeX piano control panel.

**24 Sostenuto Pedal (grand piano)**

Used to sustain one group of notes while other notes are played without sustain.

**25 Muting Lever (grand piano)**

Used to mute the acoustic piano sound. Pull the lever gently to the left to activate AnyTime mode. Do not attempt to activate/deactivate AnyTime mode while playing the instrument as this can cause serious damage to the action mechanism of the instrument.

# 2. BASIC OPERATION

This section provides the basic procedures for turning the power on, activating AnyTime mode, and performing with headphones.

- **Step 1**  
Plug the AC adaptor into the DC IN connector located at the rear of the instrument.



- **Step 2**  
Plug the AC adaptor's power plug into the electric wall outlet.

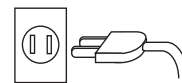

- **Step 3**  
Turn the Power/Volume knob clockwise, to the half-way position.

The LED above the Power/Volume knob will light up to indicate that the AnyTimeX control panel is turned on.



## ◇ ACTIVATING ANYTIME MODE

- **Step 4**

### Upright piano:

Depress the Mute pedal, then slide it gently to the left to mute the acoustic piano sound and activate AnyTime mode.

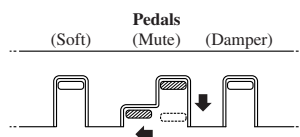

### Grand piano:

Pull the Muting lever to the left to mute the acoustic piano sound and activate AnyTime mode.

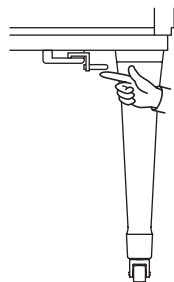

Do not attempt to activate/deactivate AnyTime mode while playing the piano, as this can cause serious damage to the action mechanism of the instrument.

## ◇ PERFORMING WITH HEADPHONES

### □ Step 5

Connect a pair of headphones to one of the Phones jacks located on the underside of the control box.

Two pairs of headphones can be connected simultaneously, allowing two people to listen to the AnyTimeX piano at the same time.

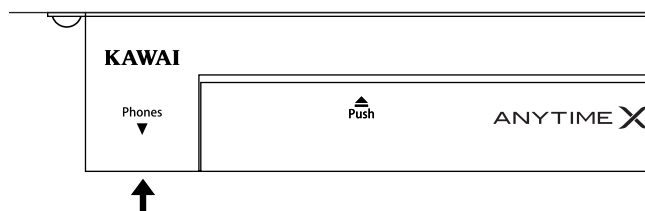

Play the piano.

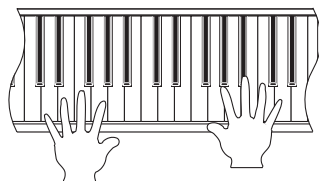

The sound of a Concert Grand piano will be played through the headphones, with the acoustic piano sound muted.

## ◇ ABOUT THE SOUNDBOARD SPEAKER (ATX-F)

ATX-f upright and grand pianos feature a unique integrated soundboard speaker system, allowing the digital AnyTimeX sound to be played without the use of headphones.

In addition, when AnyTime mode is deactivated (i.e. the acoustic piano sound is not muted), it is also possible to enjoy playing ensemble pieces that feature both the acoustic piano sound and digital AnyTimeX sound simultaneously, such as piano with strings.

# 3. INTERNAL SOUNDS

The AnyTimeX piano features 22 realistic tones/sounds suitable for various musical styles. Sounds can be played individually, or layered together, with additional reverberation effects simulating the acoustic environment of a recital room, live stage or concert hall.

Sound Name	Description
Concert Grand	The sound of a KAWAI concert grand piano.
Concert Grand 2	
Studio Grand	The sound of a brightly strung grand piano.
Studio Grand 2	
Mellow Grand	The sound of a softly strung grand piano.
Mellow Grand 2	
Modern Piano	The sound of a modern grand piano.
Rock Piano	The sound of a rock piano, brighter than that of Modern Piano.
Classic E.Piano	The sound of a classic electric piano.
Modern E.P.	The sound of a modern electric piano.
Slow Strings	The sound of an ensemble of strings.
String Pad	
String Ensemble	
Choir	The sound of an ensemble of singers.
Harpsichord	The sound of a Baroque period plucked string instrument.
Harpsichord Oct.	
Vibraphone	The sound of a percussive, tuned instrument played using mallets.
Church Organ	The sound a pipe organ, suitable for Church music etc.
Diapason	
Jazz Organ	The sound of an electronic organ.
Drawbar Organ	NOTE: When either organ sound is selected, the soft pedal is used to alter the speed of the rotary speaker simulation between 'Slow' and 'Fast' effect modes.
New Age Pad	The sound of a synthesized science fiction atmosphere.

## □ Preparation

1. Turn on the AnyTimeX piano using the Power/Volume knob located on the right of the control box.
2. Depress the Mute pedal, then slide it gently to the left to mute the acoustic piano sound and activate AnyTime mode.
3. Push the front of the control box to reveal the control panel.

Concert Grand

Concert Grand will be shown in the LCD display. The LED indicators for the Tone and Reverb buttons will also turn on.

## 1) SINGLE TONE MODE

### □ Step 1

Press the ▲ or ▼ Value buttons to select the desired sound.

### □ Step 2

Play the piano.

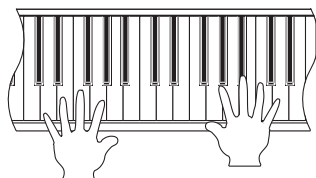

The selected sound will be heard as the keys are pressed. Use the Power/Volume knob to adjust the volume if necessary.

■ The AnyTimeX piano is capable of playing up to 192 notes simultaneously (192-note polyphony).

## 2) DUAL MODE

The DUAL function allows two sounds to be layered together, creating a more complex sound. For example, a piano can be layered with strings, or a church organ with a choir sound.

- Step 1  
Press the ▲ or ▼ Value buttons to select the desired primary sound.

- Step 2  
Press the Dual button to activate Dual mode.

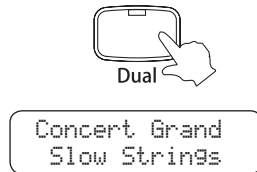

The LED indicator for the Dual button will turn on.

The primary sound will be shown on the upper line of the LCD display, while the secondary sound will be shown on the lower line.

- Step 3  
Press the ▲ or ▼ Value buttons to select the desired secondary sound.

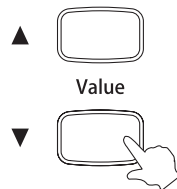

- Step 4  
Play the piano.

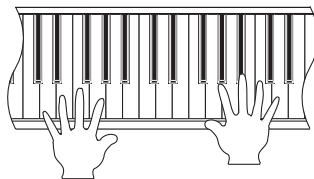

The two different sounds will be heard at the same time.

- Step 5  
Press the Dual button again to deactivate Dual mode.

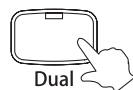

The LED indicator for the Dual button will turn off.

The secondary sound shown on the lower line of the LCD display will disappear, leaving the primary sound shown on the upper line.

Pressing the Dual button once again will reactivate Dual mode, recalling the previously selected primary and secondary sounds.

Alternatively, press the ▲ and ▼ Value buttons at the same time to deactivate Dual mode and select the default Concert Grand sound.

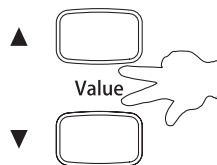

■ To change the primary sound while Dual mode is activated, first press the Dual button to deactivate Dual mode, then press the ▲ or ▼ Value buttons to select the new primary sound. Finally, press the Dual button once again to reactivate Dual mode.

■ To adjust the volume balance between the primary and secondary sounds, please refer to the instructions on page 25 - 0) DUAL BALANCE.

## 3) REVERB

Reverb adds reverberation to the sound, simulating the acoustic environment of a recital room, stage, or concert hall.

There are five types of reverb available:

- ◆ Room 1, 2 : Simulates the sound of a small room, adding a soft reverberation.
- ◆ Stage : Simulates the sound of playing on a live stage.
- ◆ Hall 1, 2 : Simulates the deep reverberation of a larger concert hall.

### □ Step 1

Press the Reverb button to activate the reverb simulation.



The LED indicator for the Reverb button will turn on, indicating that the reverb simulation has been activated.

### □ Step 2

#### ■ Method A

Press and hold the Reverb button, then press the ▲ or ▼ Value buttons to select the desired reverb type.

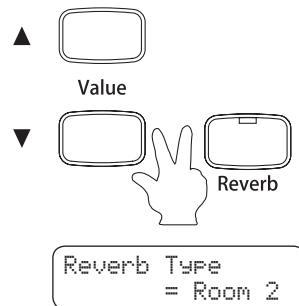

The currently selected reverb type will be shown on the second line of the LCD display.

#### ■ Method B

Alternatively, the Menu button can also be used to select the desired reverb type.

Please refer to the instructions on page 44 - 15) REVERB TYPE - for more information.

### □ Step 3

Play the piano.

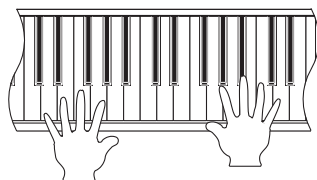

The selected reverb type will be applied to the sound.

### □ Step 4

Press the Reverb button once again to deactivate the reverb simulation.

The LED indicator for the Reverb button will turn off, indicating that the reverb simulation has been deactivated.

■ If the Reverb button is pressed once again, the reverb simulation will be reactivated with the previously selected type.

# 4. METRONOME

Rhythm is one of the most important elements when learning music. It is important to practice playing the piano at the correct tempo and with a steady rhythm. The metronome function helps learners to achieve this by providing a steady beat to perform to.

## □ Preparation

1. Turn on the AnyTimeX control panel.
2. Activate AnyTime mode.
3. Push the front of the control box to reveal the control panel.

## ◇ ACTIVATING THE METRONOME

### □ Step 1

Press the Metronome button to activate the metronome.



The LED indicator for the Metronome button will turn on, indicating that the metronome has been activated.

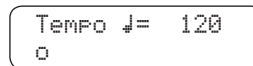

The current metronome tempo will be shown in the LCD display for a brief period, before returning to show the selected tone.

## ◇ ADJUSTING THE METRONOME TEMPO

### □ Step 2

While the tempo of the metronome is shown in the LCD display, press the ▲ or ▼ Value buttons to adjust the tempo to the desired value.

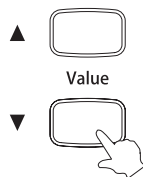

The metronome tempo will begin to increase and decrease as the value is adjusted.

- ◆ The metronome tempo can be adjusted within the range of 10-400 beats per minute.
- ◆ To recall the metronome tempo after the display returns to showing the selected tone, press the Metronome button.

## ◇ CHANGING THE METRONOME TIME SIGNATURE

### □ Step 3

By default, the metronome will produce a clicking sound at a constant volume - this is a 1-beat or 1/4 time signature. It is also possible to select alternative time signatures when appropriate. There are ten different types of metronome time signature available: 1/4, 2/4, 3/4, 4/4, 5/4, 3/8, 6/8, 7/8, 9/8 and 12/8. When selecting a time signature other than 1/4, a bell sound will be heard indicating the first beat of the bar.

#### ■ Method A

Press and hold the Metronome button, then press the ▲ or ▼ Value buttons to select the desired metronome time signature.

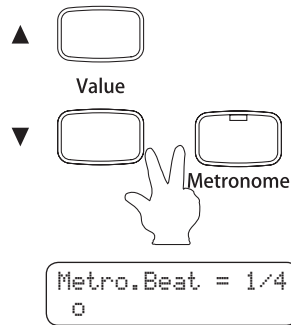

The current metronome time signature will be shown in the LCD display until the Metronome button is released.

#### ■ Method B

Alternatively, the Menu button can also be used to select the desired metronome time signature. Please refer to the instructions on page 45 - 16) METRONOME BEAT - for more information.

## ◇ ADJUSTING THE METRONOME VOLUME

To adjust the volume of the metronome, please refer to the instructions on page 46 - 17) METRONOME VOLUME - for more information.

## ◇ DEACTIVATING THE METRONOME

### □ Step 4

When metronome information is shown in the LCD display, press the Metronome button once again to deactivate the metronome.



The LED indicator for the Metronome button will turn off, indicating that the metronome has been deactivated.

- If the metronome has been activated, but the selected tone is shown in the LCD display, first press the Metronome button to recall the metronome information, before pressing the Metronome button once again to deactivate the metronome.
- If, after the metronome has been deactivated, the Metronome button is pressed once again, the metronome will be reactivated with the previously selected tempo and time signature.



# 5. RECORDER

The RECORDER function records performances in a similar way to that of an audio tape recorder. However, the AnyTimeX piano records songs as digital data, instead of audio data - storing the music inside the instrument. With a maximum of nine song memories, the recorder function provides a useful tool for both practicing and playing the piano.

## □ Preparation

1. Turn on the AnyTimeX control panel.
2. Activate AnyTime mode.
3. Push the front of the control box to reveal the control panel.
4. Select the desired sound for the performance.

It is also possible to activate the metronome, providing a steady beat in which to perform to. Note that the metronome will not be audible when the recorded performance is played back.

## 1) RECORDING A SONG

### □ Step 1

Press the Rec button to activate the recorder.

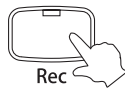

The LED indicator for the Rec button will start to flash, indicating that the recorder has been activated.

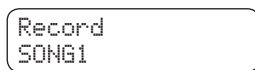

The selected recorder song (SONG1-SONG9) will be shown on the second line of the LCD display.

### □ Step 2

Press the ▲ or ▼ Value buttons to select the desired recorder song.

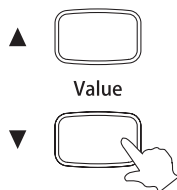

### □ Step 3

Play the piano.

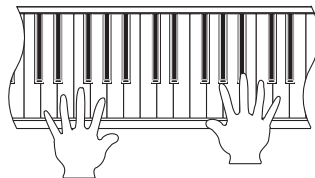

The recorder will automatically start recording with the first note played.

The LED indicators for the Rec and Play/Stop buttons will turn on.

Alternatively, the recording can also be started by pressing the Play/Stop button instead of pressing a key, to allow the recording of songs that begin on an 'up' beat.

□ Step 4

Press the Play/Stop button to stop recording.

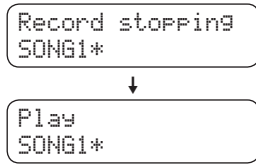

The LED indicators for the Rec and Play/Stop buttons will turn off.

The recorder will automatically switch to playback mode.

□ Step 5

Press the Tone button to deactivate the recorder.

The selected tone will be shown in the LCD display.

- The total recording capacity of the AnyTimeX piano is approximately 75,000 notes for the entire nine song memory. When the maximum capacity is reached, recording will stop, the LED indicators for the Rec and Play/Stop buttons will turn off, and all music recorded up until that point will be stored in memory automatically.
- Any changes made to the sound while recording will also be recorded. Adjusting the tempo, however, will not be recorded.
- Recorded songs stored inside the memory of the AnyTimeX piano will remain even after turning off the power.

## 2) PLAYING BACK A SONG

The Play/Stop button is used to start and stop playback of the recorded song, and to also select which song is played.

### □ Step 1

Press the Play/Stop button to activate playback mode.



Play  
SONG1\*

The selected recorder song (SONG1-SONG9) will be shown on the second line of the LCD display.

### □ Step 2

Press the ▲ or ▼ Value buttons to select the desired song for playback.

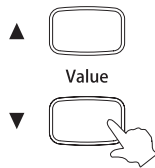

Note the asterisk (\*) to the right of the song name, indicating a previously recorded performance.

### □ Step 3

Press the Play/Stop button once again to start playback of the selected song.



The LED indicator for the Play/Stop button will turn on during playback.

### □ Step 4

To adjust the tempo of the recorded song during playback, first press the Metronome button, then press the ▲ or ▼ Value buttons.

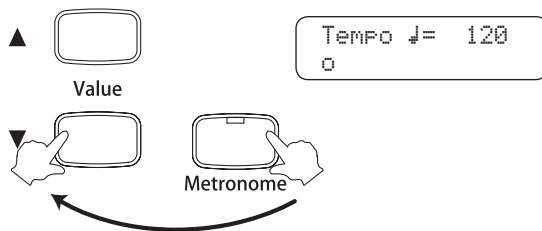

The current metronome tempo will be shown in the LCD display.

The metronome will be audible. Press the Metronome button once again to deactivate the metronome.

### □ Step 5

Press the Play/Stop button once again to stop playback.



Play  
SONG1\*

The LED indicator for the Play/Stop button will turn off.

The selected recorder song (SONG1-SONG9) will once again be shown on the second line of the LCD display.

### □ Step 6

Press the Tone button to deactivate playback mode.



The selected tone will be shown in the LCD display.

# 3) DELETING A SONG

This function allows recorded songs that are no longer required, to be deleted.

## □ Step 1

### ■ Method A

Press the Play/Stop and Rec buttons simultaneously.



The LED indicators for the Play/Stop and Rec buttons will start to flash.

The selected recorder song (SONG1-SONG9) will be shown on the second line of the LCD display.

### ■ Method B

Alternatively, the Menu button can also be used to delete recorded songs.

Please refer to the instructions on page 48 - 19) DELETE RECORDED SONG - for more information.

## □ Step 2

Press the ▲ or ▼ Value buttons to select the song to be deleted.

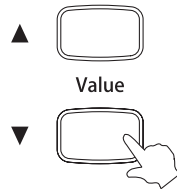

## □ Step 3

Press the Rec button to delete the selected song.



A confirmation message will be shown in the LCD display.

## □ Step 4-1: Confirm Delete

Press the Rec button once again to confirm deleting of the selected song.



'Completed' will be shown in the LCD display, before returning to the song playback mode.

■ Repeat the steps above in order to delete recorded songs individually.

■ To delete all recorded songs from memory at once, first turn off the power and then turn it on again, holding down both the Rec button and the Play/Stop button.

□ Step 4-2: Cancel Delete

To cancel the delete operation in Step 3, press the Play/Stop button.



Delete  
SONG1\* Canceled

'Canceled' will be shown in the LCD display, before returning to song delete mode.

Delete  
SONG1\*\*Press Rec

□ Step 5

Press the Tone button to deactivate delete mode.



The selected tone will be shown in the LCD display.

# 6. DEMO MODE

The AnyTimeX piano features a selection of classical demonstration pieces, including works by Handel, Bach, Beethoven and Chopin.

## ◇ LIST OF DEMONSTRATION PIECES

Piece Name	Composer
① Tambourin	J.P. Rameau
② The Harmonious Blacksmith	G.F. Händel
③ Menuett BWV. Anh.114	J.S. Bach
④ Menuett BWV. Anh.115	
⑤ Menuett BWV. Anh.116	
⑥ Le Coucou	L.C. Daquin
⑦ Gavotte	F.J. Gossec
⑧ Menuett	L. Boccherini
⑨ Thema und Variationen (Sonate für Klavier No.11 K.331(300i))	W.A. Mozart
⑩ Türkischer Marsch (Sonate für Klavier No.11 K.331(300i))	
⑪ Menuett	
⑫ Sonate für Klavier No.14 "Mondschein"	L.v. Beethoven
⑬ Sonate für Klavier No.8 "Pathétique"	
⑭ Für Elise	
⑮ Rondo favori	J.N. Hummel
⑯ Impromptu op.90-4	F.P. Schubert
⑰ Moments musicaux op.94-3	
⑱ Entr'acte	
⑲ Impromptu op.142-3	
⑳ Auf Flügeln des Gesanges	F. Mendelssohn
㉑ Frühlingslied	
㉒ Rondo Capriccioso	
㉓ Chanson de l'adieu	F.F. Chopin
㉔ Raindrop	
㉕ Petit chien	
㉖ Nocturne No.2	
㉗ Fantaisie-Impromptu	
㉘ Polonaise No.3 "Militaire"	
㉙ Polonaise No.6 "Héroïque"	

### □ Preparation

1. Turn on the AnyTimeX control panel.
2. Activate AnyTime mode.
3. Push the front of the control box to reveal the control panel.

## ◇ LISTENING TO DEMONSTRATION PIECES

- **Step 1**  
Press the Demo button.

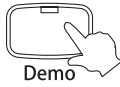

Heroique  
Chopin

A demonstration piece will start to play.

The piece name and composer will be shown on the first and second lines of the LCD display.

The LED indicator for the Demo button will turn on.

- **Step 2**

■ **Method A**

Press the ▲ or ▼ Value buttons to select the desired demonstration piece.

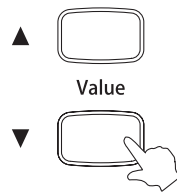

■ **Method B**

Alternatively, the Menu button can also be used to set the default demonstration piece. Please refer to the instructions on page 42 - 13) FIRST DEMO - for more information.

- **Step 3**  
Press either the Demo or Play/Stop buttons to stop the demonstration performance.

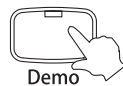

The LED indicator for the Demo button will turn off.

Press the Demo button once again to restart playback of the previously selected demonstration piece.

- Selecting different tones is not possible during playback of the demonstration pieces.
- The selected tone will automatically return to the Concert Grand sound after stopping the demonstration pieces.
- If left uninterrupted, the AnyTimeX piano will play each demonstration piece sequentially. To alter the demonstration playback procedure, please refer to the instructions on page 43 - 14) DEMO REPEAT.

# 7. MENU FUNCTIONS

The Menu functions allow various parameters of the AnyTimeX piano to be adjusted. If necessary, these settings can be stored in the User Memory and conveniently recalled when turning on the AnyTimeX piano.

## □ Preparation

1. Turn on the AnyTimeX control panel.
2. Activate AnyTime mode.
3. Push the front of the control box to reveal the control panel.

## ◇ MENU FUNCTION LIST

There are 22 menu functions in total, with items 1-9 responsible for controlling the Virtual Technician functions of the AnyTimeX piano.

### Virtual Technician

- 1) Voicing
- 2) Damper Resonance
- 3) String Resonance
- 4) Key Off Effect
- 5) Touch
- 6) Temperament
- 7) Key of Temperament
- 8) Tuning
- 9) Stretch Tuning

0) Dual Balance

10) Transpose

11) MIDI Channel

12) Local Control

13) First Demo

14) Demo Repeat

15) Reverb Type

16) Metronome Beat

17) Metronome Volume

18) Loudness

19) Delete Recorded Song

20) User Memory

21) Factory Reset

### Virtual Technician

An experienced piano technician is essential to fully realise the potential of an acoustic piano. As well as meticulously tuning each note, the technician performs regulation and voicing adjustments that allow a fine instrument to truly sing.

Virtual Technician functions simulate such refinements digitally. The Voicing feature shapes tonal characteristics, while the Touch function allows the performer to select the level of touch sensitivity suitable for his/her playing style.

The String Resonance feature causes held notes to resonate 'sympathetically' with other notes of the same harmonic series, while Damper Resonance recreates a similar phenomenon, whereby sympathetic and adjacent notes resonate while the damper pedal is depressed. Finally, the Key Off Effect recreates the sound of bass hammers returning to their strings following a rapid note release.



## 0) DUAL BALANCE

This function allows the volume balance between primary and secondary sounds in Dual Mode to be adjusted, and will only be available if Dual mode is activated.

- **Step 1**  
Press the Dual button to activate Dual mode.

- **Step 2**  
Press the Menu button to select the Dual Balance function.

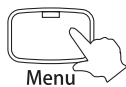

0.Dual Balance  
= 5 - 5

The LED indicator for the Menu button will turn on.

The Dual Balance menu function will be shown in the LCD display.

The primary sound volume is represented by the number on the left, while the secondary sound volume is represented by the number on the right.

- **Step 3**  
Press the ▲ or ▼ Value buttons to select the desired volume balance.

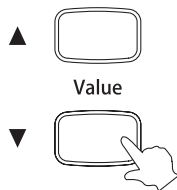

- ◆ The sum of the primary and secondary sound volume balances will always total 10 (e.g. '1-9', '5-5', '9-1', etc.), with larger values producing greater volume.

- **Step 4**  
Press the Tone button to exit the Dual Balance menu.



The LED indicator for the Menu button will turn off.

The selected tone will be shown in the LCD display.

Alternatively, press the Menu button again to select other menu functions.

- The Dual Balance function will return to the default setting of '5-5' when the ▲ and ▼ Value buttons are pressed at the same time, or when the power is turned off.
- The User Memory function can be used to store the desired Dual Balance setting, allowing the preferred Dual Balance setting to remain selected even after the power is turned off. Please refer to the instructions on page 49 - 20) USER MEMORY - for more information.

# 1) VOICING

Voicing is a technique used by piano technicians to mould the character of a piano's sound. This function allows the tonal quality of the AnyTimeX piano to be set to one of six types of voicing.

## □ Step 1

Press the Menu button repeatedly, or press and hold the Menu button then press the ▲ or ▼ Value buttons, until the Voicing function is selected.

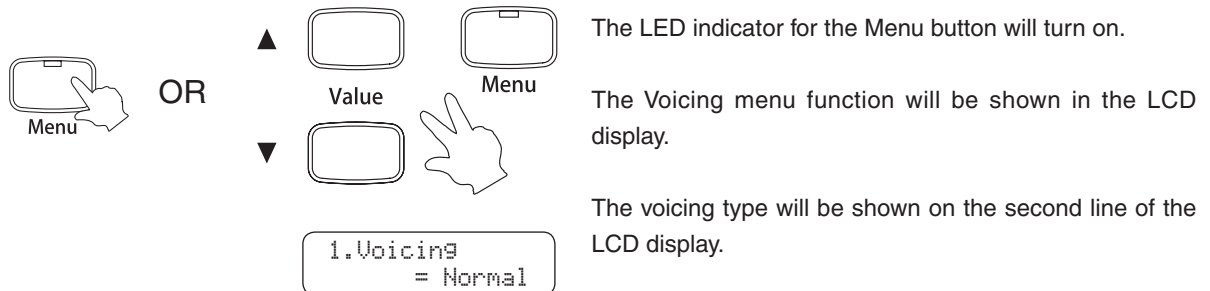

## □ Step 2

Press the ▲ or ▼ Value buttons to select the desired voicing type.

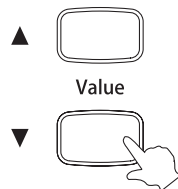

- **Normal** : The normal tone character of an acoustic piano throughout the entire dynamic range. This is the default voicing setting.
- **Mellow 1, 2** : A softer mellow tone character throughout the entire dynamic range. Mellow 2 is softer than Mellow 1.
- **Dynamic** : The tone character will change dramatically from mellow to bright depending on how soft or hard the piano is played.
- **Bright 1, 2** : A brighter tone character throughout the entire dynamic range. Bright 2 is brighter than Bright 1.

## □ Step 3

Play the piano.

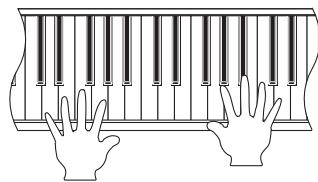

The voicing type selected in Step 2 will be applied to the sound.

## □ Step 4

Press the Tone button to exit the Voicing menu.



The LED indicator for the Menu button will turn off.

The selected tone will be shown in the LCD display.

Alternatively, press the Menu button again to select other menu functions.

- The Voicing function will return to the default setting of 'Normal' when the ▲ and ▼ Value buttons are pressed at the same time, or when the power is turned off.
- The User Memory function can be used to store the desired Voicing setting, allowing the preferred Voicing setting to remain selected even after the power is turned off. Please refer to the instructions on page 49 - 20) USER MEMORY - for more information.

## 2) DAMPER RESONANCE

When the damper pedal is depressed on an acoustic piano, all dampers are lifted up, allowing the strings to vibrate freely. When a note or chord is played on the piano with the damper pedal depressed, not only will the strings of the notes played vibrate, but also the strings of other notes, vibrating in sympathetic resonance. The Damper Resonance function of the AnyTimeX piano attempts to simulate this phenomenon.

### □ Step 1

Press the Menu button repeatedly, or press and hold the Menu button then press the ▲ or ▼ Value buttons, until the Damper Resonance function is selected.

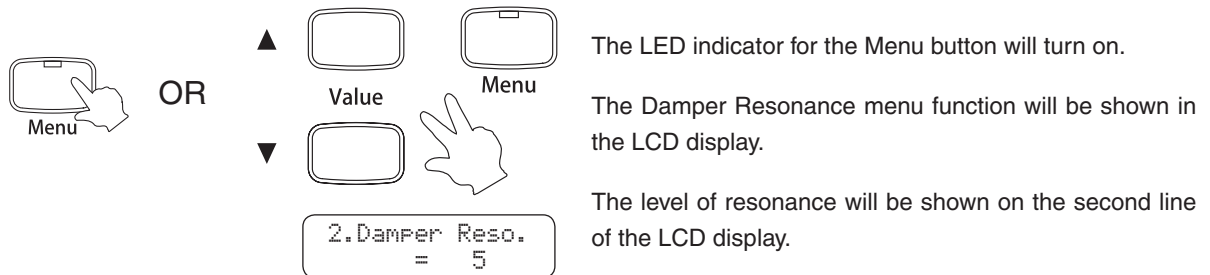

### □ Step 2

Press the ▲ or ▼ Value buttons to select the desired damper resonance level.

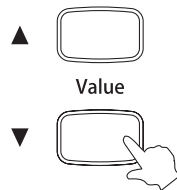

◆ A damper resonance level of '1' produces a very subtle effect, while the maximum level of '10' creates a stronger, more pronounced resonance. Setting the damper resonance to 'Off' will disable the function entirely.

### □ Step 3

Play the piano while using the damper pedal.

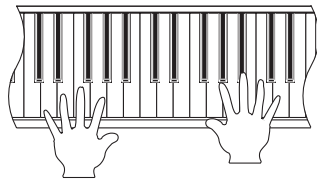

The degree of resonance will vary, depending on the value specified in Step 2.

### □ Step 4

Press the Tone button to exit the Damper Resonance menu.



The LED indicator for the Menu button will turn off.

The selected tone will be shown in the LCD display.

Alternatively, press the Menu button again to select other menu functions.

- The Damper Resonance function will only be applied to the Concert Grand, Concert Grand 2, Studio Grand, Studio Grand 2, Mellow Grand, and Mellow Grand 2 piano sounds.
- The Damper Resonance function will return to the default setting of '5' when the ▲ and ▼ Value buttons are pressed at the same time, or when the power is turned off.
- The User Memory function can be used to store the desired Damper Resonance setting, allowing the preferred Damper Resonance setting to remain selected even after the power is turned off. Please refer to the instructions on page 49 - 20) USER MEMORY - for more information.

## 3) STRING RESONANCE

String Resonance refers to a phenomenon present among acoustic pianos, whereby the strings of held notes resonate 'sympathetically' with other notes of the same harmonic series. The String Resonance function of the AnyTimeX piano attempts to simulate this phenomenon.

### □ Step 1

Press the Menu button repeatedly, or press and hold the Menu button then press the ▲ or ▼ Value buttons, until the String Resonance function is selected.

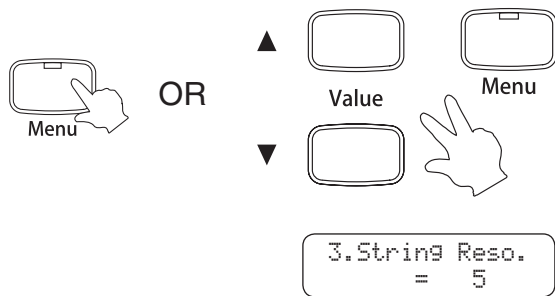

The LED indicator for the Menu button will turn on.

The String Resonance menu function will be shown in the LCD display.

The level of resonance will be shown on the second line of the LCD display.

### □ Step 2

Press the ▲ or ▼ Value buttons to select the desired string resonance level.

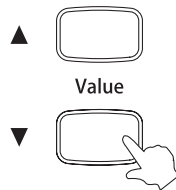

◆ A string resonance level of '1' produces a very subtle effect, while the maximum level of '10' creates a strong, more pronounced resonance. Setting the string resonance to 'Off' will disable the function entirely.

### □ Step 3

Play the piano, holding down one key while playing other keys of the keyboard.

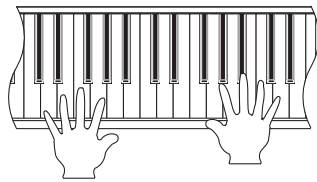

The degree of resonance will vary, depending on the value specified in Step 2.

### □ Step 4

Press the Tone button to exit the String Resonance menu.



The LED indicator for the Menu button will turn off.

The selected tone will be shown in the LCD display.

Alternatively, press the Menu button again to select other menu functions.

### ■ About String Resonance

Even when the damper pedal is not depressed on an acoustic piano, the strings for any notes held will be un-dampened and will resonate freely in sympathy with the strings of other notes that you play if they are part of the same harmonic series. In addition, adjacent notes will also resonate.

For example, when playing the keys shown below while holding down the 'C' key, the string of the 'C' key resonates and produces a sound.

Quietly press and hold down the 'C' key, and then quickly tap each of the keys shown below. Depending on the value specified in Step 2, it should be possible to clearly hear the String Resonance simulation.

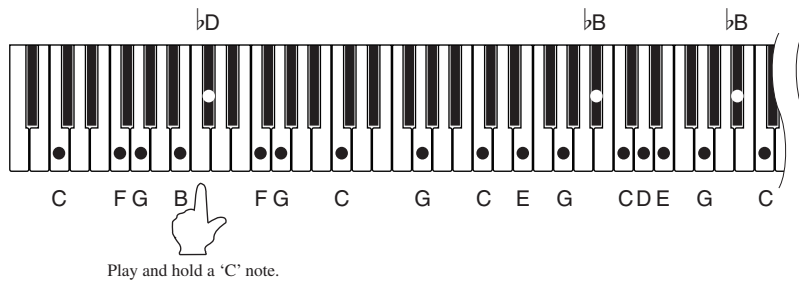

- The String Resonance function will only be applied to the Concert Grand, Concert Grand 2, Studio Grand, Studio Grand 2, Mellow Grand, Mellow Grand 2, Modern Piano and Rock Piano piano sounds.
- The String Resonance function will not be applied while the damper pedal is depressed.
- The String Resonance function will return to the default setting of '5' when the ▲ and ▼ Value buttons are pressed at the same time, or when the power is turned off.
- The User Memory function can be used to store the desired String Resonance setting, allowing the preferred String Resonance setting to remain selected even after the power is turned off. Please refer to the instructions on page 49 - 20) USER MEMORY - for more information.

## 4) KEY OFF EFFECT



Especially for low-pitched tones, when a key is played strongly and released quickly, the sound of the damper touching the strings can often be heard immediately before the sound stops. The Key Off Effect function of the AnyTimeX piano attempts to simulate this phenomenon.

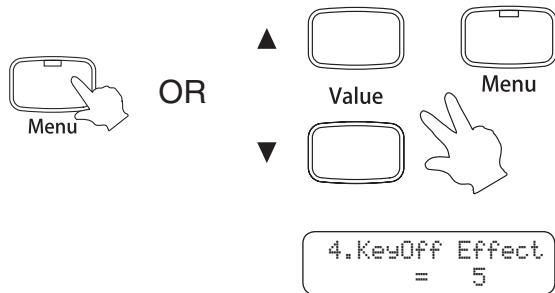

### □ Step 1

Press the Menu button repeatedly, or press and hold the Menu button then press the ▲ or ▼ Value buttons, until the Key Off Effect function is selected.



OR

▲    
Value Menu

▼  

The LED indicator for the Menu button will turn on.

The Key Off Effect menu function will be shown in the LCD display.

The key off effect level will be shown on the second line of the LCD display.

```
4. KeyOff Effect
= 5
```

### □ Step 2

Press the ▲ or ▼ Value buttons to select the desired key off effect level.

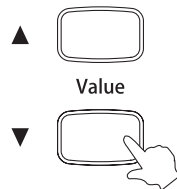

◆ A key off effect level of '1' produces a very subtle effect, while the maximum level of '10' creates a strong, more pronounced key off sound. Setting the key off effect to 'Off' will disable the function entirely.

### □ Step 3

Play the piano.

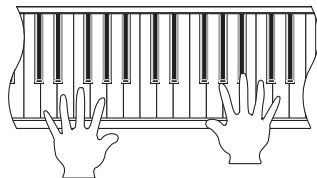

The strength of the key off effect will vary, depending on the value specified in Step 2.

### □ Step 4

Press the Tone button to exit the Key Off Effect menu.



The LED indicator for the Menu button will turn off.

The selected tone will be shown in the LCD display.

Alternatively, press the Menu button again to select other menu functions.

- The Key Off Effect will only be applied to the Concert Grand, Concert Grand 2, Studio Grand, Studio Grand 2, Mellow Grand, Mellow Grand 2, Modern Piano and Rock Piano piano sounds.
- The Key Off Effect function will return to the default setting of '5' when the ▲ and ▼ Value buttons are pressed at the same time, or when the power is turned off.
- The User Memory function can be used to store the desired Key Off Effect setting, allowing the preferred Key Off Effect setting to remain selected even after the power is turned off. Please refer to the instructions on page 49 - 20) USER MEMORY - for more information.

# 5) TOUCH

The Touch function allows different touch sensitivities for the keyboard to be selected, other than the standard touch of an acoustic piano. The sensitivity can be changed to one of six different settings: Light, Light +, Normal, Heavy, Heavy +, or Off.

①Light +	: For players with a delicate touch. Requires less striking force to achieve a forte note.
②Light	: For those still developing finger strength. A louder volume is produced even when playing with a soft touch.
③Normal	: Reproduces the standard touch sensitivity of an acoustic piano throughout the entire dynamic range.
④Heavy	: For those with strong fingers. Requires a heavier touch to produce a loud volume.
⑤Heavy +	: Requires even greater striking force to achieve a loud volume.
⑥Off	: A constant volume is produced regardless of how hard the keys are struck. This setting is suitable for sounds that have a fixed dynamic range such as Organ and Harpsichord.

- **Step 1**  
Press the Menu button repeatedly, or press and hold the Menu button then press the ▲ or ▼ Value buttons, until the Touch function is selected.

OR

▲ Value      Menu

▼ Value

The LED indicator for the Menu button will turn on.

The Touch menu function will be shown in the LCD display.

The touch type will be shown on the second line of the LCD display.

- **Step 2**  
Press the ▲ or ▼ Value buttons to select the desired touch setting.

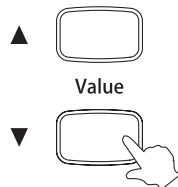

- **Step 3**  
Play the piano.

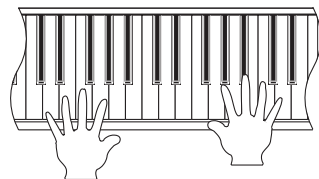

The touch responsiveness of the keyboard will vary, depending on the setting selected in Step 2.

- **Step 4**  
Press the Tone button to exit the Touch menu.



The LED indicator for the Menu button will turn off.

The selected tone will be shown in the LCD display.

Alternatively, press the Menu button again to select other menu functions.

- The Touch function will return to the default setting of 'Normal' when the ▲ and ▼ Value buttons are pressed at the same time, or when the power is turned off.
- The User Memory function can be used to store the desired Touch setting, allowing the preferred Touch setting to remain selected even after the power is turned off. Please refer to the instructions on page 49 - 20) USER MEMORY - for more information.

## 6) TEMPERAMENT

The AnyTimeX piano offers immediate access to a variety of musical temperaments popular during the Renaissance and Baroque periods. It may prove interesting and educational to experiment with different temperaments, other than the modern 'equal temperament' standard that is dominant in music today.

The following temperaments are available:

<ul style="list-style-type: none"> <li>◆ Equal Temperament (piano) (Equal P. only)</li> </ul>	<p>This is the default temperament. If a piano sound is selected the tuning is stretched like an acoustic piano (Equal Temperament). If any other type of sound is selected the tuning will be Equal (flat). An explanation of Equal Temperament and Equal Temperament (flat) is provided later in this section.</p> <p>If a piano sound is used in a layer with any other sound, then both sounds will use the Equal Temperament (stretched) tuning.</p>
<ul style="list-style-type: none"> <li>◆ Pure Temperament (major) (Pure major)</li> <li>◆ Pure Temperament (minor) (Pure minor)</li> </ul>	<p>This temperament, which eliminates dissonances for thirds and fifths, is still popular for choral music because of its perfect harmony.</p> <p>Performers must be aware which key they are playing in when using this temperament.</p> <p>Any key modulation will result in dissonances. When playing music in a particular key, the key of the temperament must also be correctly matched.</p> <p>When playing in a major key select Pure (major) and when playing in a minor key select Pure (minor).</p>
<ul style="list-style-type: none"> <li>◆ Pythagorean Temperament (Pythagorean)</li> </ul>	<p>This temperament, which uses mathematical ratios to eliminate dissonance for fifths, is very limited for use with chords, but it produces very characteristic melodic lines.</p>
<ul style="list-style-type: none"> <li>◆ Meantone Temperament (Meantone)</li> </ul>	<p>This temperament, which uses a mean between a major and minor whole tone to eliminate dissonance for thirds, was devised to eliminate the lack of consonances experienced with certain fifths for the Mersenne Pure Temperament. It produces chords that are more beautiful than those with the Equal Temperament.</p>
<ul style="list-style-type: none"> <li>◆ Werckmeister III Temperament (Werckmeister)</li> <li>◆ Kirnberger III Temperament (Kirnberger)</li> </ul>	<p>These two temperaments are placed in between Meantone and Pythagorean.</p> <p>For music with few accidentals, this temperament produces the beautiful chords of the mean tone, but as accidentals increase, the temperament produces the characteristic melodies of the Pythagorean Temperament. It is used primarily for classical music written in the Baroque era to revive the original characteristics.</p>
<ul style="list-style-type: none"> <li>◆ Equal Temperament (flat) (Equal Flat)</li> </ul>	<p>This is an 'unstretched' Equal Temperament that divides the scale into twelve equal semitones. This produces the same chordal intervals in all twelve keys, and has the advantage of limitless modulation of the key. However the tonality of each key becomes less characteristic and no chord is in pure consonance.</p>
<ul style="list-style-type: none"> <li>◆ Equal Temperament (stretched)</li> </ul>	<p>This is the most popular piano temperament. The hearing ability of a human is uneven and is not as accurate with high frequency and low frequency as it is with the middle range. This temperament's tuning is stretched to compensate for this so the sound will be heard naturally to the ears. This 'stretched' Equal Temperament is a practical variation of the 'unstretched' Equal Temperament which was invented on a mathematical basis.</p>



□ Step 1

Press the Menu button repeatedly, or press and hold the Menu button then press the ▲ or ▼ Value buttons, until the Temperament function is selected.

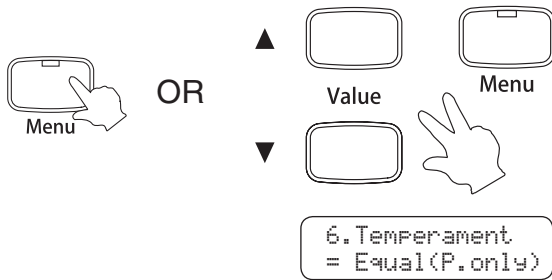

The LED indicator for the Menu button will turn on.

The Temperament menu function will be shown in the LCD display.

The temperament type will be shown on the second line of the LCD display.

□ Step 2

Press the ▲ or ▼ Value buttons to select the desired temperament type.

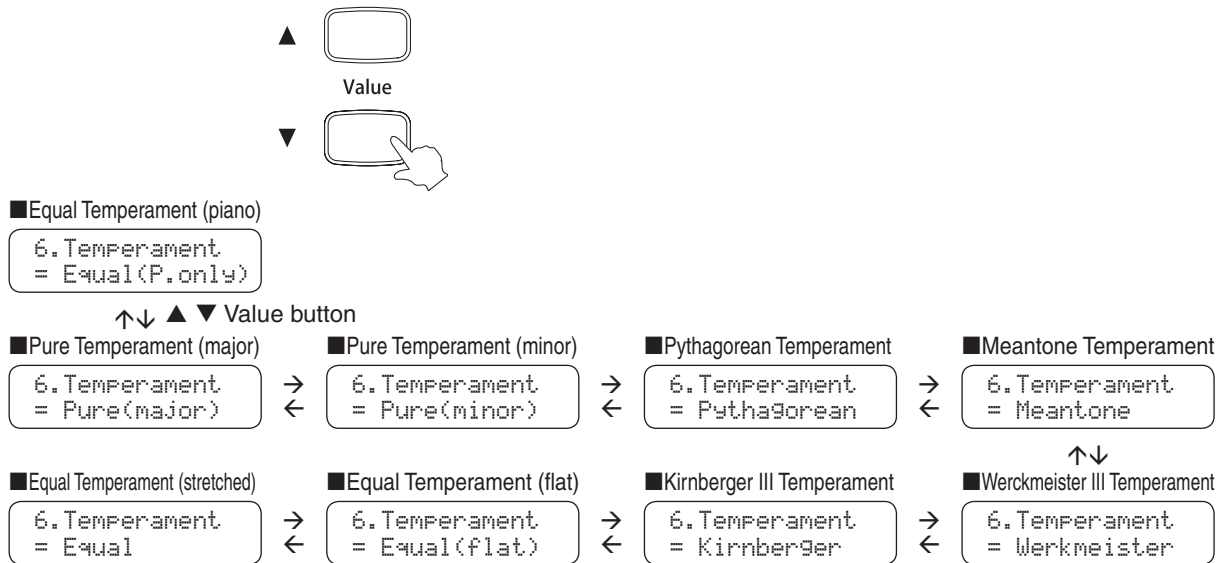

■ After selecting the desired temperament type, please refer to the instructions on page 34 - 7) KEY OF TEMPERAMENT - for information regarding the key signature of the selected temperament.

□ Step 3

Play the piano.

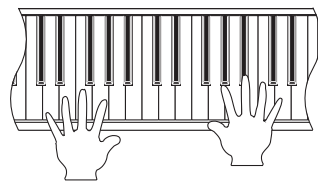

The temperament selected in Step 2 will be utilised for the sound.

□ Step 4

Press the Tone button to exit the Temperament menu.



The LED indicator for the Menu button will turn off.

The selected tone will be shown in the LCD display.

Alternatively, press the Menu button again to select other menu functions.

- The Temperament function will return to the default setting of 'Equal Temperament (piano)' when the ▲ and ▼ Value buttons are pressed at the same time, or when the power is turned off.
- The User Memory function can be used to store the desired Temperament setting, allowing the preferred Temperament setting to remain selected even after the power is turned off. Please refer to the instructions on page 49 - 20) USER MEMORY - for more information.

## 7) KEY OF TEMPERAMENT

Limitless modulation of the key only became available after the invention of Equal Temperament. When using a temperament other than Equal Temperament, care must be taken to choose the correct key signature. For example, if the song to be played is written in D major, 'D' would be chosen as the temperament key. The Key of Temperament function allows the desired key signature for the selected temperament to be selected. Please note that the Key of Temperament function will not be available if Equal Temperament is selected.

### □ Step 1

Press the Menu button repeatedly, or press and hold the Menu button then press the ▲ or ▼ Value buttons, until the Key of Temperament function is selected.

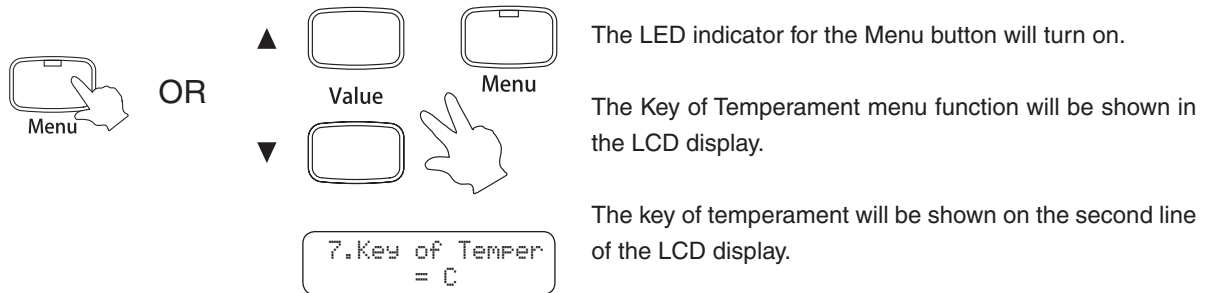

### □ Step 2

Press the ▲ or ▼ Value buttons to select the desired key of temperament setting.

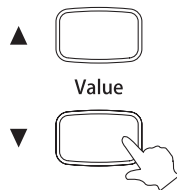

◆ The key of temperament can be set between the range of 'C' to 'B'.

### □ Step 3

Play the piano.

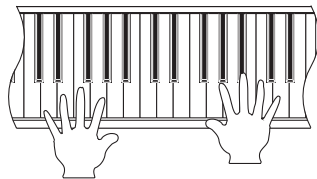

The key of temperament selected in Step 2 will be utilised for the sound.

### □ Step 4

Press the Tone button to exit the Key of Temperament menu.



The LED indicator for the Menu button will turn off.

The selected tone will be shown in the LCD display.

Alternatively, press the Menu button again to select other menu functions.

- The Key of Temperament function cannot be altered when Equal Temperament is selected.
- The Key of Temperament function will return to the default setting of 'C' when the ▲ and ▼ Value buttons are pressed at the same time, or when the power is turned off.
- The User Memory function can be used to store the desired Key of Temperament setting, allowing the preferred Key of Temperament setting to remain selected even after the power is turned off. Please refer to the instructions on page 49 - 20) USER MEMORY - for more information.

## 8) TUNING

The Tuning function allows the pitch of the AnyTimeX piano to be finely adjusted, and may prove useful when playing with other instruments.

### □ Step 1

Press the Menu button repeatedly, or press and hold the Menu button then press the ▲ or ▼ Value buttons, until the Tuning function is selected.

The LED indicator for the Menu button will turn on.

The Tuning menu function will be shown in the LCD display.

The current tuning setting will be shown on the second line of the LCD display.

### □ Step 2

Press the ▲ or ▼ Value buttons to set the desired tuning value.

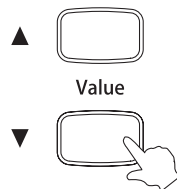

- ◆ The tuning value can be set within the range of 427.0 to 453.0 (Hz).
- ◆ The pitch will be changed by 0.5 Hz increments each time one of the Value buttons is pressed.

### □ Step 3

Play the piano.

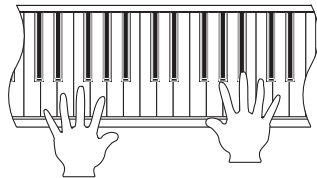

The tuning value set in Step 2 will be utilised for the sound.

### □ Step 4

Press the Tone button to exit the Tuning menu.



The LED indicator for the Menu button will turn off.

The selected tone will be shown in the LCD display.

Alternatively, press the Menu button again to select other menu functions.

- The Tuning function will return to the default setting of '440.0 Hz' when the ▲ and ▼ Value buttons are pressed at the same time, or when the power is turned off.
- The User Memory function can be used to store the desired Tuning setting, allowing the preferred Tuning setting to remain selected even after the power is turned off. Please refer to the instructions on page 49 - 20) USER MEMORY - for more information.

## 9) STRETCH TUNING

Stretch tuning is a piano-specific tuning method in which the tuning for the lower notes is slightly lower and the tuning for the higher notes is slightly higher than the settings made in the Equal Temperament. The Stretch Tuning function determines the level of stretch tuning. There are two type of stretch tuning available, Normal and Wide. Please note that the Stretch Tuning function will only be available if either Equal Temperament (piano) or Equal Temperament is selected.

### □ Step 1

Press the Menu button repeatedly, or press and hold the Menu button then press the ▲ or ▼ Value buttons, until the Stretch Tuning function is selected.

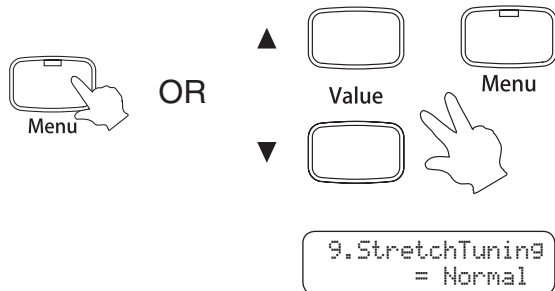

The LED indicator for the Menu button will turn on.

The Stretch Tuning menu function will be shown in the LCD display.

The stretch tuning type will be shown on the second line of the LCD display.

### □ Step 2

Press the ▲ or ▼ Value buttons to select the desired stretch tuning type.

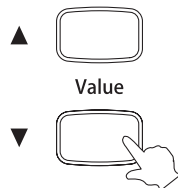

◆ The stretch tuning function can be set to either 'Normal' or 'Wide', which - as the name would suggest - creates a more pronounced tuning adjustment for the lower and higher notes.

### □ Step 3

Play the piano.

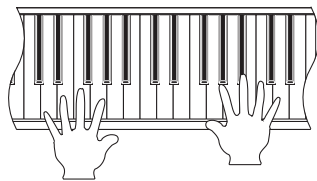

The type of stretch tuning selected in Step 2 will be utilised for the sound.

### □ Step 4

Press the Tone button to exit the Stretch Tuning menu.



The LED indicator for the Menu button will turn off.

The selected tone will be shown in the LCD display.

Alternatively, press the Menu button again to select other menu functions.

- The Stretch Tuning function can only be altered if Equal Temperament (piano) or Equal Temperament is selected.
- The Stretch Tuning function will return to the default setting of 'Normal' when the ▲ and ▼ Value buttons are pressed at the same time, or when the power is turned off.
- The User Memory function can be used to store the desired Stretch Tuning setting, allowing the preferred Stretch Tuning setting to remain selected even after the power is turned off. Please refer to the instructions on page 49 - 20) USER MEMORY - for more information.

# 10) TRANSPOSE

The transpose function allows the key of the AnyTimeX piano to be raised or lowered in half steps. This is particularly useful when accompanying instruments with different tones, or when a song learned in one key must be played in another key.

## □ Step 1

Press the Menu button repeatedly, or press and hold the Menu button then press the ▲ or ▼ Value buttons, until the Transpose function is selected.

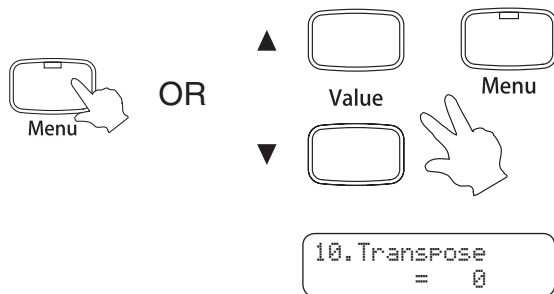

The LED indicator for the Menu button will turn on.

The Transpose menu function will be shown in the LCD display.

The current transpose setting will be shown on the second line of the LCD display.

## □ Step 2

Press the ▲ or ▼ Value buttons to set the desired transpose value.

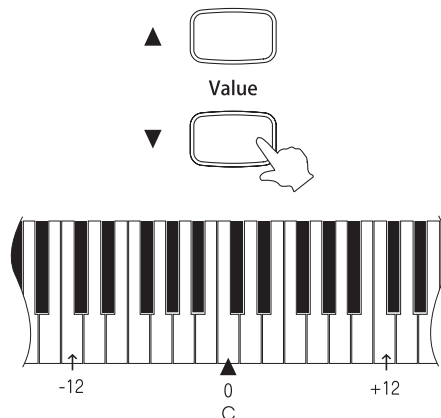

The 'C' key in the centre of the piano keyboard corresponds to the value '0'.

The piano pitch can be transposed by up to 12 halftones higher or 12 halftones lower.

## □ Step 3

Play the piano.

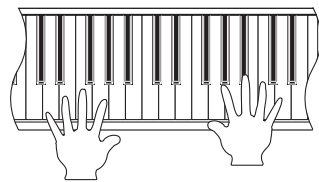

The transpose value set in Step 2 will be applied to the sound.

## □ Step 4

Press the Tone button to exit the Transpose menu.



The LED indicator for the Menu button will turn off.

The selected tone will be shown in the LCD display.

Alternatively, press the Menu button again to select other menu functions.

- The Transpose function will return to the default setting of '0' when the ▲ and ▼ Value buttons are pressed at the same time, or when the power is turned off.
- The User Memory function can be used to store the desired Transpose setting, allowing the preferred Transpose setting to remain selected even after the power is turned off. Please refer to the instructions on page 49 - 20) USER MEMORY - for more information.

# 11) MIDI CHANNEL

## ◇ MIDI OVERVIEW

The term MIDI is an acronym for Musical Instrument Digital Interface, an international standard for connecting synthesizers, sequencers (MIDI recorders) and other electronic instruments in order to exchange performance data.

The AnyTimeX piano is equipped with two MIDI jacks for exchanging data: MIDI IN and MIDI OUT. Each uses a special cable with a DIN connector.

MIDI IN : For receiving note, program change and other data.

MIDI OUT : For sending note, program change and other data.

MIDI uses channels to exchange data back and forth between MIDI devices. There are receive (MIDI IN) and transmit (MIDI OUT) channels. Most musical instruments or devices with MIDI functions are equipped with both MIDI IN and MIDI OUT jacks and are capable of transmitting and receiving data via MIDI.

The receive channels are used to receive data from another MIDI device and the transmit channels are used to transmit data to another MIDI device.

MIDI connection example:

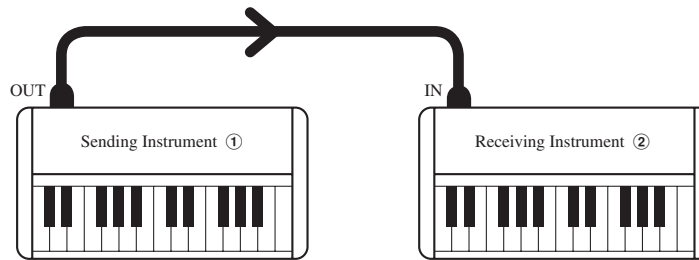

When connected as shown in the illustration above, MIDI data sent from ① will be also played on ② if both channels match.

MIDI instruments have 16 channels for sending and receiving MIDI data.

## ◆ MIDI Examples

### ◆ Connection to a sequencer:

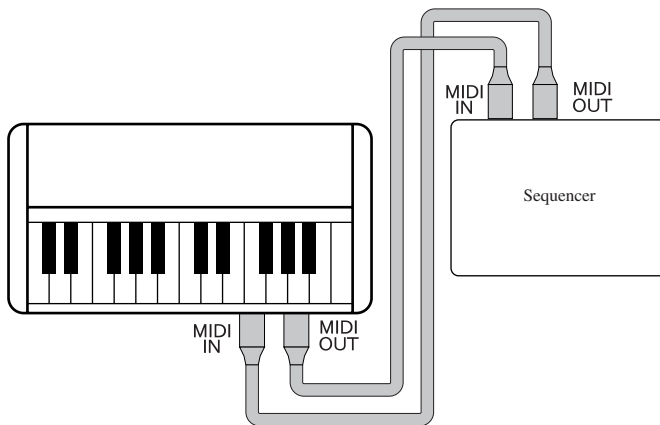

When connected as shown in this illustration, songs played on the AnyTimeX piano can be recorded with a sequencer, and then played back at any time.

### ◆ Connection to another MIDI compatible keyboard or module:

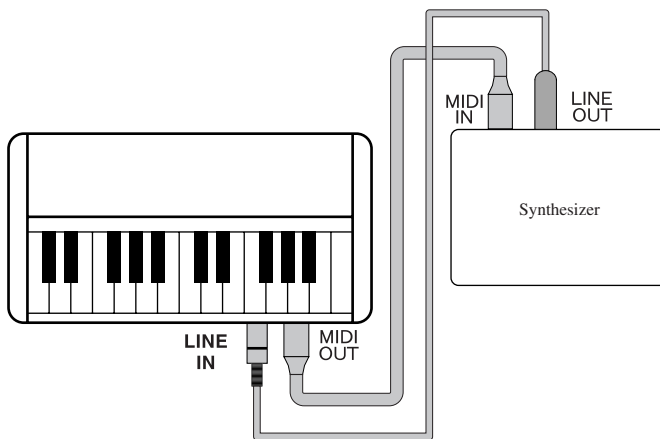

When connected as shown in this illustration, MIDI data sent from the AnyTimeX piano can also be played on a separate synthesizer. Moreover, the audio output from the synthesizer can also be connected directly to the AnyTimeX piano.

Such a combination, for example, would allow the AnyTimeX piano sound to be combined with that of a String tone from a separate synthesizer.

## ◆ MIDI Functions

The AnyTimeX piano is capable of the following MIDI functions:

- ◆ Sending/Receiving keyboard note information (i.e. which keys are pressed).
- ◆ Sending/Receiving pedal information (i.e. ON/OFF data for the damper, soft and sostenuto pedals).
- ◆ Receiving volume data (i.e. adjusting the volume of the AnyTimeX piano using a separate MIDI instrument).
- ◆ Sending/Receiving exclusive data.
- ◆ Sending recorded playback data (i.e. allowing recorded performances to be played using a separate MIDI device or saved using an external sequencer).

Please refer to the complete listing on page 54 - MIDI Implementation Chart - for more information regarding MIDI functionality.

■ MIDI Program Change numbers

Sound Name	Program Number
Concert Grand	1
Concert Grand 2	2
Studio Grand	3
Studio Grand 2	4
Mellow Grand	5
Mellow Grand 2	6
Modern Piano	7
Rock Piano	8
Classic E.Piano	9
Modern E.P.	10
Slow Strings	11

Sound Name	Program Number
String Pad	12
String Ensemble	13
Choir	14
Harpsichord	15
Harpsichord Oct.	16
Vibraphone	17
Church Organ	18
Diapason	19
Jazz Organ	20
Drawbar Organ	21
New Age Pad	22

The MIDI Channel function is used to determine on which MIDI channel the AnyTimeX piano will exchange MIDI information with external MIDI devices and instruments.

The selected channel will function as both the Transmit and Receive channel.

□ Step 1

Press the Menu button repeatedly, or press and hold the Menu button then press the ▲ or ▼ Value buttons, until the MIDI Channel function is selected.

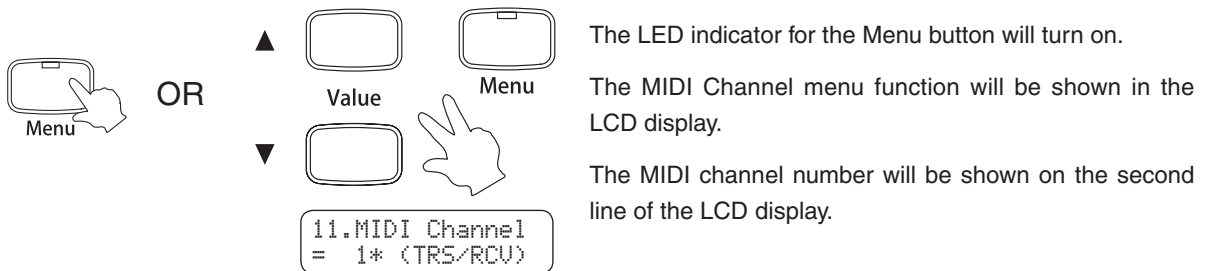

▲ Value      Menu

▼ Value

11. MIDI Channel  
= 1\* (TRS/RCU)

The LED indicator for the Menu button will turn on.  
The MIDI Channel menu function will be shown in the LCD display.  
The MIDI channel number will be shown on the second line of the LCD display.

□ Step 2

Press the ▲ or ▼ Value buttons to select the desired MIDI channel.

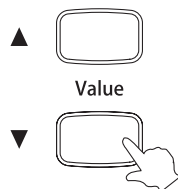

- The MIDI Channel can be set to 1\* or can be set to a specific channel within the range of 1 to 16. The default AnyTimeX piano MIDI Channel setting is set to receive MIDI channel information from all channels, 1 to 16. This is often referred to as 'OMNI ON'. If, however, a specific MIDI Channel is selected, the AnyTimeX piano will be set to 'OMNI OFF' and data will only be received on that specified channel.

□ Step 3

Press the Tone button to exit the MIDI Channel menu.



- The LED indicator for the Menu button will turn off.
- The selected tone will be shown in the LCD display.

Alternatively, press the Menu button again to select other menu functions.

- The MIDI Channel function will return to the default setting of '1\*' ('OMNI ON') when the ▲ and ▼ Value buttons are pressed at the same time, or when the power is turned off.
- The User Memory function can be used to store the desired MIDI Channel setting, allowing the preferred MIDI Channel setting to remain selected even after the power is turned off. Please refer to the instructions on page 49 - 20) USER MEMORY - for more information.



## 12) LOCAL CONTROL

This function determines whether the AnyTimeX piano will play a sound when the keyboard is played.



With Local Control set to 'On', the AnyTimeX piano will play a sound when the keyboard is played. However, even with Local Control set to 'Off', the AnyTimeX piano keyboard will continue to transmit data on the selected MIDI channel to an external MIDI device or personal computer.

### □ Step 1

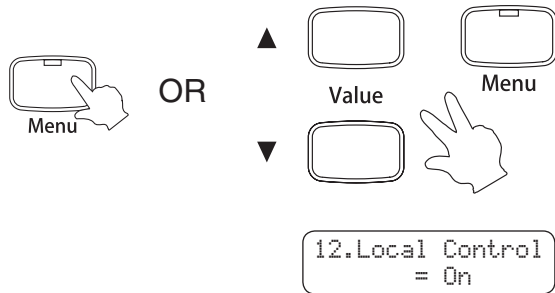

Press the Menu button repeatedly, or press and hold the Menu button then press the ▲ or ▼ Value buttons, until the Local Control function is selected.



OR

▲   The LED indicator for the Menu button will turn on.

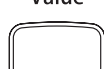
Value Menu

▼   The Local Control menu function will be shown in the LCD display.

The local control setting will be shown on the second line of the LCD display.

12. Local Control  
= On

### □ Step 2

Press the ▲ or ▼ Value buttons to enable or disable the local control setting.

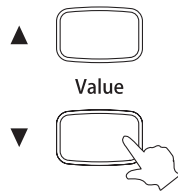

### □ Step 3

Press the Tone button to exit the Local Control menu.



The LED indicator for the Menu button will turn off.

The selected tone will be shown in the LCD display.

Alternatively, press the Menu button again to select other menu functions.

- The Local Control function will return to the default setting of 'On' when the ▲ and ▼ Value buttons are pressed at the same time, or when the power is turned off.
- The User Memory function can be used to store the desired Local Control setting, allowing the preferred Local Control setting to remain selected even after the power is turned off. Please refer to the instructions on page 49 - 20) USER MEMORY - for more information.

# 13) FIRST DEMO

This function allows the default demonstration piece - played when pressing the Demo button - to be changed.

## □ Step 1

Press the Menu button repeatedly, or press and hold the Menu button then press the ▲ or ▼ Value buttons, until the First Demo function is selected.

The LED indicator for the Menu button will turn on.

The First Demo menu function will be shown in the LCD display.

The name of the default demonstration piece will be shown on the second line of the LCD display.

## □ Step 2

Press the ▲ or ▼ Value buttons to select the desired default demonstration piece.

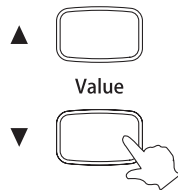

## □ Step 3

Press the Tone button to exit the First Demo function menu.



The LED indicator for the Menu button will turn off.

The selected tone will be shown in the LCD display.

Alternatively, press the Menu button again to select other menu functions.

The piece selected in Step 2 will be played upon pressing the Demo button.



- The First Demo function will return to the default setting of 'No. 29: Heroique' when the ▲ and ▼ Value buttons are pressed at the same time, or when the power is turned off.
- The User Memory function can be used to store the desired First Demo setting, allowing the preferred First Demo setting to remain selected even after the power is turned off. Please refer to the instructions on page 49 - 20) USER MEMORY - for more information.

# 14) DEMO REPEAT

This function allows the order in which demonstration pieces are played back to be changed.

There are 3 different playback styles:

- ◆ 1 song : Repeat the demonstration piece until a button is pressed to stop the performance.
- ◆ Chain : Play each demonstrations piece 1-29 in order.
- ◆ Random : Play the demonstration pieces in a random order.

## □ Step 1

Press the Menu button repeatedly, or press and hold the Menu button then press the ▲ or ▼ Value buttons, until the Demo Repeat function is selected.

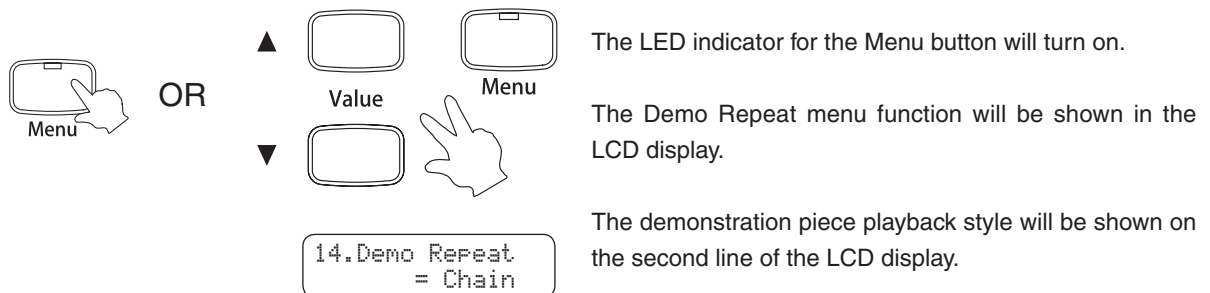

## □ Step 2

Press the ▲ or ▼ Value buttons to select the desired demonstration piece playback style.

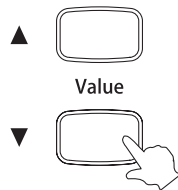

## □ Step 3

Press the Tone button to exit the Demo Repeat function menu.



The LED indicator for the Menu button will turn off.

The selected tone will be shown in the LCD display.

Alternatively, press the Menu button again to select other menu functions.

The demonstration piece playback style selected in Step 2 will be used upon pressing the Demo button.



- The Demo Repeat function will return to the default setting of 'Chain' when the ▲ and ▼ Value buttons are pressed at the same time, or when the power is turned off.
- The User Memory function can be used to store the desired Demo Repeat setting, allowing the preferred Demo Repeat setting to remain selected even after the power is turned off. Please refer to the instructions on page 49 - 20) USER MEMORY - for more information.

# 15) REVERB TYPE

The function allows the default reverb type to be changed.

## □ Step 1

Press the Menu button repeatedly, or press and hold the Menu button then press the ▲ or ▼ Value buttons, until the Reverb Type function is selected.

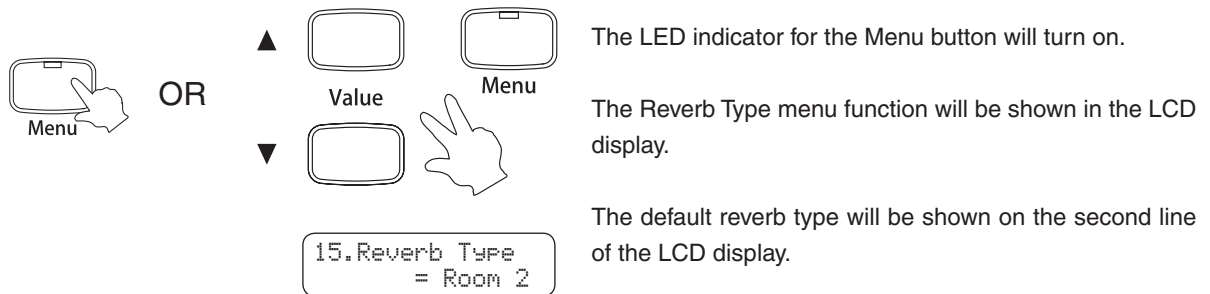

## □ Step 2

Press the ▲ or ▼ Value buttons to select the desired default reverb type.

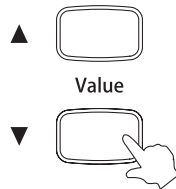

## □ Step 3

Press the Tone button to exit the Reverb Type function menu.



The LED indicator for the Menu button will turn off.

The selected tone will be shown in the LCD display.

Alternatively, press the Menu button again to select other menu functions.

- Please refer to the information on page 14 - 3) REVERB - for an explanation of the various reverb types.
- The Reverb Type function will return to the default settings for each sound when the ▲ and ▼ Value buttons are pressed at the same time, or when the power is turned off.
- The User Memory function can be used to store the desired Reverb Type setting, allowing the preferred Reverb Type setting to remain selected even after the power is turned off. Please refer to the instructions on page 49 - 20) USER MEMORY - for more information.

# 16) METRONOME BEAT

The function allows the default metronome time signature to be changed.

## □ Step 1

Press the Menu button repeatedly, or press and hold the Menu button then press the ▲ or ▼ Value buttons, until the Metronome Beat function is selected.

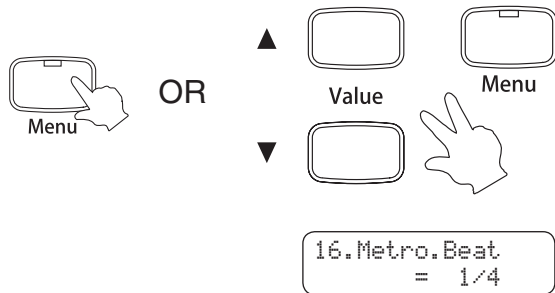

The diagram shows two methods to enter the menu. On the left, a hand presses a button labeled 'Menu'. In the center, the word 'OR' is written. To the right of 'OR', there are two rows of buttons. The top row shows an up arrow (▲) above a button labeled 'Value' and a button labeled 'Menu'. The bottom row shows a down arrow (▼) above a button labeled 'Value' and a hand pressing a button labeled 'Menu'. Below these is a rectangular LCD display showing '16.Metro.Beat' on the first line and '= 1/4' on the second line.

The LED indicator for the Menu button will turn on.

The Metronome Beat menu function will be shown in the LCD display.

The default metronome time signature will be shown on the second line of the LCD display.

## □ Step 2

Press the ▲ or ▼ Value buttons to select the desired default metronome time signature.

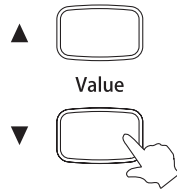

## □ Step 3

Press the Tone button to exit the Metronome Beat function menu.



The LED indicator for the Menu button will turn off.

The selected tone will be shown in the LCD display.

Alternatively, press the Menu button again to select other menu functions.

- The Metronome Beat function will return to the default setting of '1/4' when the ▲ and ▼ Value buttons are pressed at the same time, or when the power is turned off.
- The User Memory function can be used to store the desired Metronome Beat setting, allowing the preferred Metronome Beat setting to remain selected even after the power is turned off. Please refer to the instructions on page 49 - 20) USER MEMORY - for more information.

# 17) METRONOME VOLUME

The function allows the default metronome volume to be changed.

## □ Step 1

Press the Menu button repeatedly, or press and hold the Menu button then press the ▲ or ▼ Value buttons, until the Metronome Volume function is selected.

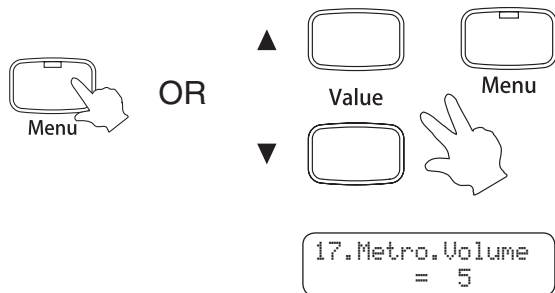

The LED indicator for the Menu button will turn on.

The Metronome Volume menu function will be shown in the LCD display.

The current metronome volume level will be shown on the second line of the LCD display.

## □ Step 2

Press the ▲ or ▼ Value buttons to select the desired default metronome volume.

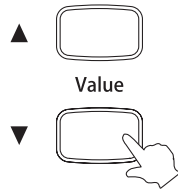

◆ The metronome volume level can be set within the range of 1 to 10.

## □ Step 3

Press the Tone button to exit the Metronome Volume function menu.

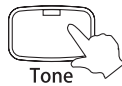

The LED indicator for the Menu button will turn off.

The selected tone will be shown in the LCD display.

Alternatively, press the Menu button again to select other menu functions.

- The Metronome Volume function will return to the default setting of '5' when the ▲ and ▼ Value buttons are pressed at the same time, or when the power is turned off.
- The User Memory function can be used to store the desired Metronome Volume setting, allowing the preferred Metronome Volume setting to remain selected even after the power is turned off. Please refer to the instructions on page 49 - 20) USER MEMORY - for more information.

# 18) LOUDNESS

This function can be used to improve the sound of bass frequencies when the volume is relatively low, providing a more satisfactory tonal balance.

## □ Step 1

Press the Menu button repeatedly, or press and hold the Menu button then press the ▲ or ▼ Value buttons, until the Loudness function is selected.

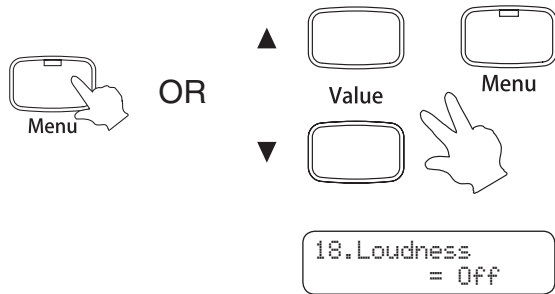

The LED indicator for the Menu button will turn on.

The Loudness menu function will be shown in the LCD display.

The current loudness setting will be shown on the second line of the LCD display.

## □ Step 2

Press the ▲ or ▼ Value buttons to enable or disable the loudness function.



The LCD display shows: 18.Loudness = On

## □ Step 3

Play the piano.

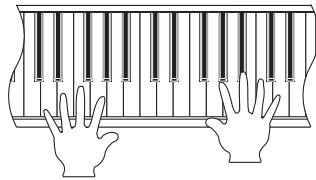

## □ Step 4

Press the Tone button to exit the Loudness function menu.

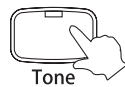

The LED indicator for the Menu button will turn off.

The selected tone will be shown in the LCD display.

Alternatively, press the Menu button again to select other menu functions.

- The loudness function is intended for use in relatively low volume playing situations. It is therefore recommended that the loudness function be turned off prior to raising the volume.
- The loudness function will return to the default setting of 'Off' when the ▲ and ▼ Value buttons are pressed at the same time, or when the power is turned off.
- The User Memory function can be used to store the desired Loudness setting, allowing the preferred Loudness setting to remain selected even after the power is turned off. Please refer to the instructions on page 49 - 20) USER MEMORY - for more information.

# 19) DELETE RECORDED SONG

## □ Step 1

Press the Menu button repeatedly, or press and hold the Menu button then press the ▲ or ▼ Value buttons, until the Delete function is selected.

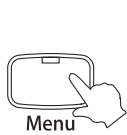

OR

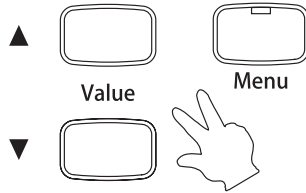

The LED indicator for the Menu button will turn on.

The Delete menu function will be shown in the LCD display.

```
19.Delete
SONG1*→Press Rec
```

The selected recorder song (SONG1-SONG9) will be shown on the second line of the LCD display.

## □ Step 2

Press the ▲ or ▼ Value buttons to select the song to be deleted.

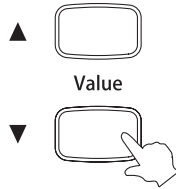

## □ Step 3

Press the Rec button to delete the selected song.

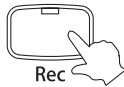

```
19.Delete Sure?
SONG1*→Press Rec
```

A confirmation message will be shown in the LCD display.

## □ Step 4-1: Confirm Delete

Press the Rec button once again to confirm deleting of the selected song.



```
19.Delete
SONG1 Completed
```

'Completed' will be shown in the LCD display, before returning to the song delete standby mode.

```
18.Delete
SONG1 →Press Rec
```

## □ Step 4-2: Cancel Delete

To cancel the delete operation in Step 3, press the Play/Stop button.



```
19.Delete
SONG1* Canceled
```

'Canceled' will be shown in the LCD display, before returning to song delete mode.

```
19.Delete
SONG1*→Press Rec
```

## □ Step 5

Press the Tone button to exit the Delete function menu.



The LED indicator for the Menu button will turn off.

The selected tone will be shown in the LCD display.

Alternatively, press the Menu button again to select other menu functions.



## 20) USER MEMORY

This function can be used to store user-definable settings, allowing the preferred settings to remain selected even after the power is turned off.

The user memory will store the following settings:

- ◆ Initially selected sound
- ◆ Menu Function settings 0-18

### □ Step 1

Press the Menu button repeatedly, or press and hold the Menu button then press the ▲ or ▼ Value buttons, until the User Memory function is selected.

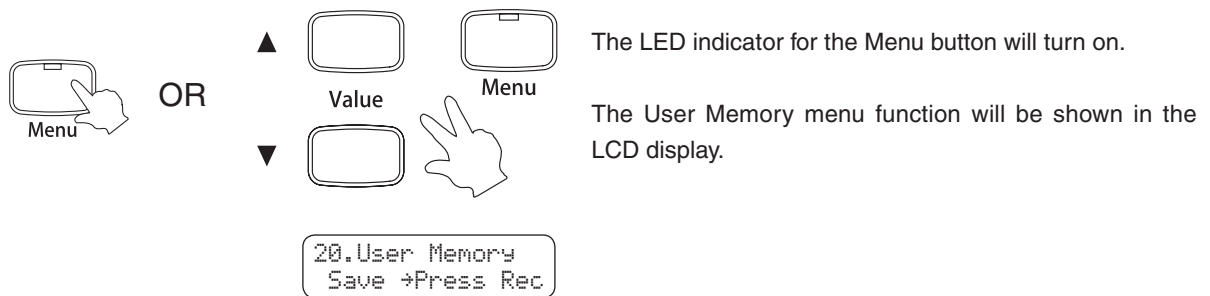

### □ Step 2

Press the Rec button to confirm saving of the user memory.

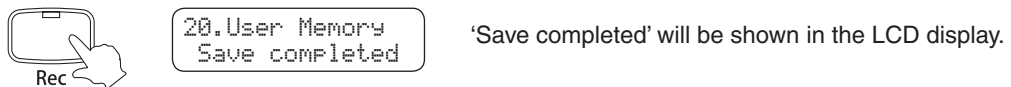

### □ Step 3

Press the Tone button to exit the User Memory function menu.

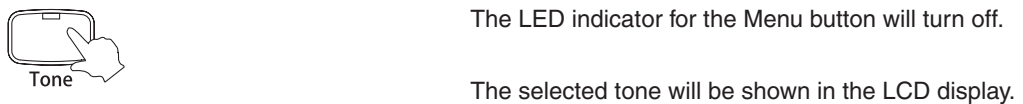

Alternatively, press the Menu button again to select other menu functions.

# 21) FACTORY RESET

This function will reset the AnyTimeX piano to the default factory settings, and is displayed only if the User Memory function has been used. All parameters saved in the User Memory will be reset to the factory preset values.

□ Step 1

Press the Menu button repeatedly, or press and hold the Menu button then press the ▲ or ▼ Value buttons, until the Factory Reset function is selected.

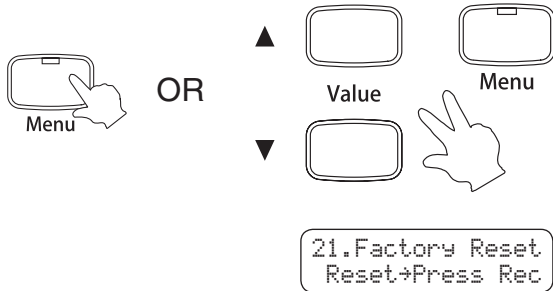

OR

▲ Value Menu

▼ Value Menu

The LED indicator for the Menu button will turn on.

The Factory Reset menu function will be shown in the LCD display.

21.Factory Reset  
Reset→Press Rec

□ Step 2

Press the Rec button to restore the default factory settings.

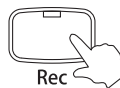

Rec

The LED indicator for the Menu button will turn off.

# 8. USB USAGE

## ◇ ABOUT THE USB CONNECTOR

- When the AnyTimeX piano is connected to a computer via a commercially available USB cable, the AnyTimeX piano will be recognised as a standard MIDI device, allowing the instrument to send and receive MIDI messages just as with a regular MIDI interface.
- Connect a 'B' type USB connector to the AnyTimeX piano and an 'A' type USB connector to the computer.

## ◇ ABOUT THE USB DRIVER

Additional driver software may be required in order to send and receive data between a computer and the AnyTimeX piano using a USB connection.

Please read the following instructions carefully for each computer/operating system type.

### ◇ Windows XP/Me users:

The standard USB-MIDI driver installed by Windows XP/Me will be used automatically - additional driver software should not be required.

To establish MIDI communications with the AnyTimeX piano, ensure that the MIDI device is defined as 'USB audio device' within the MIDI application.

### ◇ Windows Vista/2000/98SE users:

Additional USB-MIDI driver software will be required. Please download the special USB driver software from the KAWAI website at the following URL:

<http://www.kawai.co.jp/english/Download1.html>

To establish MIDI communications with the AnyTimeX piano, ensure that the MIDI IN device is defined as 'KAWAI USB MIDI IN' and that the MIDI OUT device is defined as 'KAWAI USB MIDI OUT' within the MIDI application.

### ◇ Macintosh OS X users:

The standard USB-MIDI driver will be installed automatically by Macintosh OS X - additional driver software should not be required.

To establish MIDI communications with the AnyTimeX piano, ensure that the MIDI device is defined as 'USB MIDI' within the MIDI application.

### ◇ Macintosh OS9 (or earlier) users:

The AnyTimeX piano does not support USB MIDI under Macintosh OS9 (or earlier) systems.

Please utilise a standard, commercially available MIDI interface in order to establish a MIDI connection with the AnyTimeX piano.

## ◇ NOTES ON USB USAGE

- When both MIDI jacks and the USB port are connected simultaneously, the USB port has priority.
- When connecting a USB cable to the AnyTimeX piano, first connect the USB cable and then turn the AnyTimeX piano power on.
- When connected the AnyTimeX to a computer via the USB port, there may be a short delay before MIDI communications begin.
- If the AnyTimeX piano is connected to the computer via a USB hub and the USB communication becomes unreliable/unstable, please connect the USB cable directly to the USB port of the computer.
- Turning on/off the power of the AnyTimeX piano while connected via USB, or disconnecting the USB cable suddenly, may cause computer instability in the following situations:
  - \* while installing the USB driver
  - \* while starting up the computer
  - \* while MIDI applications are performing tasks
  - \* while the AnyTimeX piano is communicating with the computer
  - \* while the computer is in energy saver mode
- If there are any further problems experienced with USB communication while the AnyTimeX piano is connected, please consult the instruction manual of your computer and double-check all connections and relevant settings.



The USB-MIDI conversion board TID10000934 utilised in the AnyTimeX piano is approved to show the USB logo.

The USB logo can be used only for products approved by the USB-IF (USB Implements Forum Inc.) test.

- ※ "MIDI" is a registered trademark of the Association of Manufacturers of Electronic Instruments (AMEI).
- ※ "Windows" is registered trademark of Microsoft Corporation.
- ※ "Macintosh" is registered trademark of Apple Computer, Inc.
- ※ Other company names and product names mentioned referenced herein may be registered trademarks or trademarks of respective owners.

# 9. APPENDIX

## ◇ SPECIFICATIONS

■ Polyphony	Maximum 192 notes	
■ Sounds	Concert Grand, Concert Grand 2, Studio Grand, Studio Grand 2, Mellow Grand, Mellow Grand 2, Modern Piano, Rock Piano, Classic E.Piano, Modern E.P., Slow Strings, String Pad, String Ensemble, Choir, Harpsichord, Harpsichord Oct., Vibraphone, Church Organ, Diapason, Jazz Organ, Drawbar Organ, New Age Pad	
■ Display	16 characters x 2 lines, LCD	
■ Reverb	Room 1, Room 2, Stage, Hall 1, Hall 2	
■ Metronome	Time signatures: 1/4, 2/4, 3/4, 4/4, 5/4, 3/8, 6/8, 7/8, 9/8, 12/8 Tempo: 10-400 BPM	
■ Recorder	9 songs (total memory capacity approximately 75,000 notes)	
■ Demonstration	29 songs	
■ Virtual Technician	Voicing (6 types), Damper Resonance, String Resonance, Key Off Effect, Touch Curve (6 types), Temperament (9 types), Tuning, Stretch Tuning (2 types)	
■ Transpose	From -12 to +12 halftones	
■ Other Functions	Dual, Dual Balance, Loudness, User Memory, Factory Reset	
■ Pedals	Upright Piano: Damper (8 levels, half-pedalling supported), Soft (switchable to Sostenuto) Grand Piano: Damper (8 levels, half-pedalling supported), Sostenuto, Soft	
■ Jacks	Headphones x2, MIDI (IN, OUT), LINE OUT (L, R), LINE IN (L, R), USB (to Host), DC IN	
■ Output Power (ATX-f)	15 W + 10 W	
■ Speakers (ATX-f)	Upright Piano: (8 cm × 12 cm) × 2 + 1.9 cm × 2 + Soundboard actuator Grand Piano: 12 cm × 2 + Soundboard actuator	
■ Power	DC 15V (using included AC adaptor)	
■ Power Consumption	ATX	15 W (using included AC adaptor)
	ATX-f	25 W (using included AC adaptor)
■ Accessories	Headphones, AC adaptor (PS-153 / PS-154), Owner's Manual, 'Classical Piano Collection' song book	

KAWAI [ ANYTIME ]  
Model ANYTIME X MIDI Implementation Chart

Date : Jun 2009  
Version : 1.0

Function...		Transmitted	Recognised	Remarks
Basic Channel	Default Changed	1 1 - 16	1 1 - 16	
Mode	Default Messages Altered	Mode 3 × *****	Mode 1 Mode 1, 3** ×	** Set to OMNI ON in the initial setting. Set to OMNI OFF by MIDI channel.
Note Number	: True voice	21 - 108* *****	0 - 127 0 - 127	* 9 - 120 including transpose
Velocity	Note ON Note OFF	○ 9nH v=1-127 × 9nH v=0	○ ×	
After Touch	Key's Ch's	× ×	× ×	
Pitch Bend		×	×	
Control Change		7 × 64 ○ (right pedal) 66 ○ (left pedal)*** 67 ○ (left pedal)	○ ○ ○ ○	Volume Damper Pedal ***Sostenuto Pedal <sup>1</sup> Soft Pedal <sup>1</sup>
Prog Change	: True #	○ (0 - 21) *****	○ 0 - 21	
System Exclusive		○	○	
Common	: Song Pos. : Song Sel. : Tune	× × ×	× × ×	
System Real time	: Clock : Commands	× ×	× ×	
Aux Mes-sages	: Local ON/OFF : All Notes OFF : Active Sense : Reset	× × ○ ×	○ ○ (123 - 127) ○ ×	
<sup>1</sup> Notes : Control Change #66 will function only when the Soft/Sostenuto pedal is set to 'Sostenuto Pedal' mode (see page 9). Control Change #67 will function only when the Soft/Sostenuto pedal is set to 'Soft Pedal' mode (default).				

Mode 1: OMNI ON, POLY  
Mode 3: OMNI OFF, POLY

Mode 2: OMNI ON, MONO  
Mode 4: OMNI OFF, MONO

○: Yes  
×: No

◇ MAINTENANCE PRECAUTIONS (UPRIGHT PIANO)

Please read the following information before attempting maintenance/servicing of the AnyTimeX piano.

Lowering the Sensor Rail

□ Step 1

Remove the four screws from the points shown below, then raise the hammer rail.

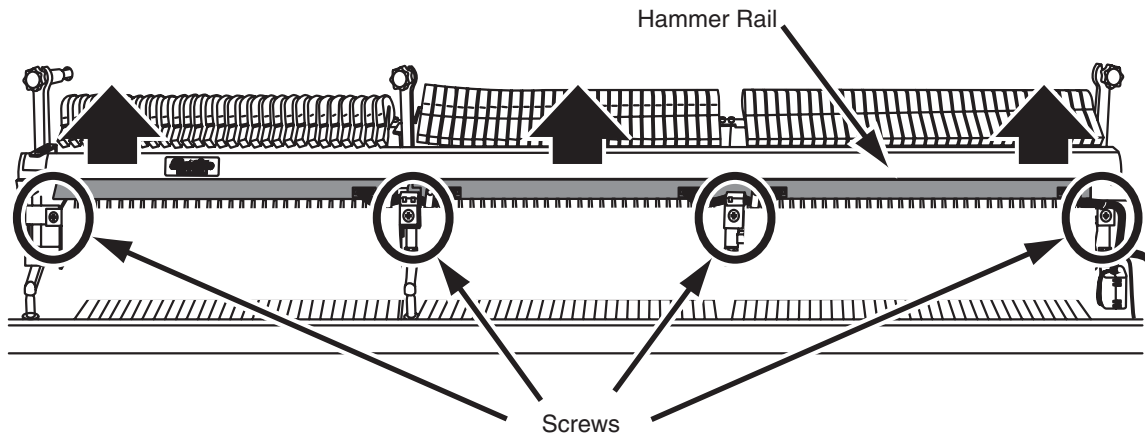

□ Step 2

While holding the hammer rail, lower the sensor rail forward gently.

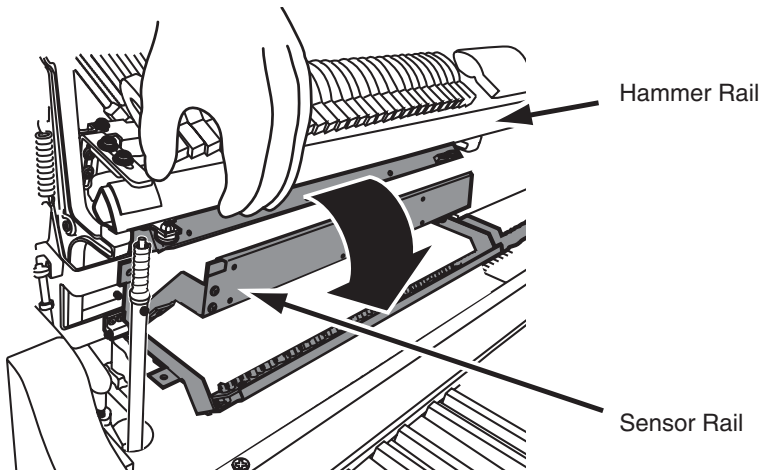

■ Caution

When removing the action, be sure to disconnect both the sensor connector and the earth/ground wire.

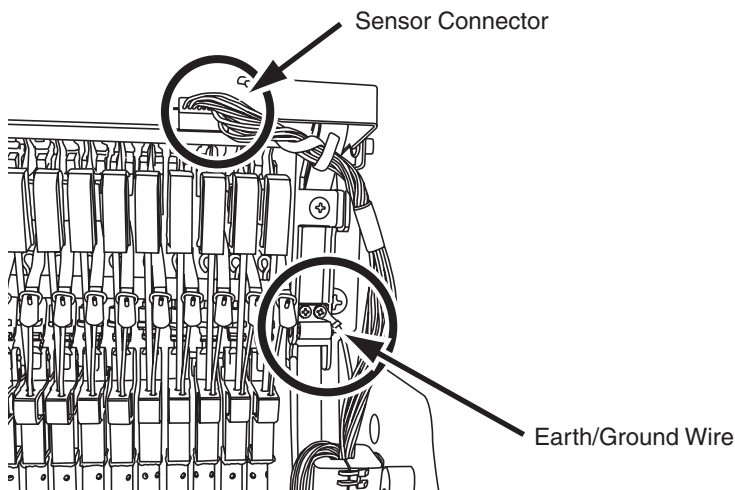

■ **Caution**

When removing the muting wire from the action, first loosen the two adjustment screws on the Hammer Rail Stopper Arm.

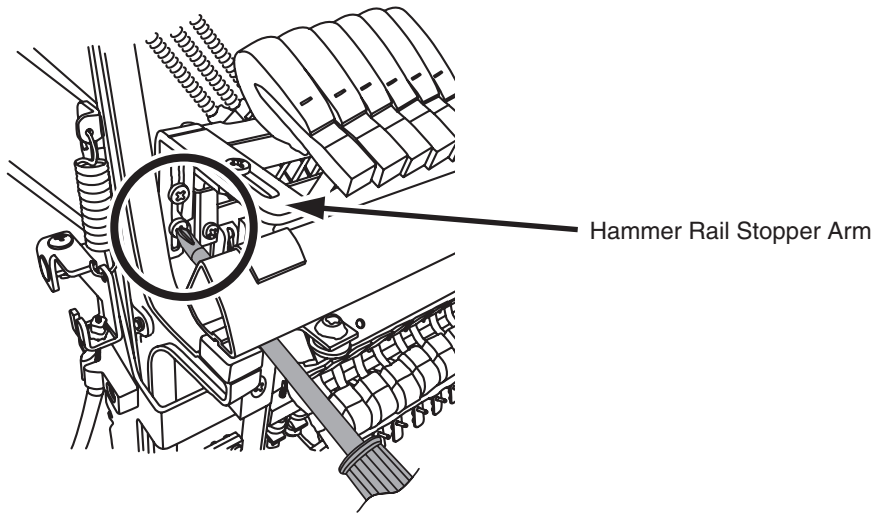

◇ MAINTENANCE PRECAUTIONS (GRAND PIANO)

Disconnecting the AnyTimeX action sensor

When maintenance of the grand piano action is required, first ensure that the power is turned off, then proceed to disconnect the AnyTimeX action sensor in the following order:

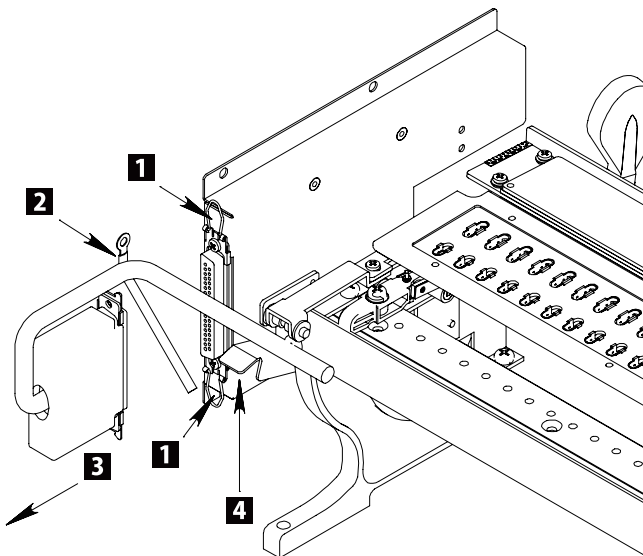

- 1** Open the locks at the top and bottom of the connector.
- 2** Unfasten the metal binder.
- 3** Unplug the connector.
- 4** Raise the lever located on the left side of the action.





# **KAWAI**

---

THE FUTURE OF THE PIANO

AnyTimeX Owner's Manual  
H-5672 : 859397  
OW016E-J0905  
Version.2  
Printed in Japan

Copyright © 2009 KAWAI Musical Instruments Mfg. Co.,Ltd. All Rights Reserved.