

# ONKYO®

## Compact Disc Player

# DX-7222

## Instruction Manual

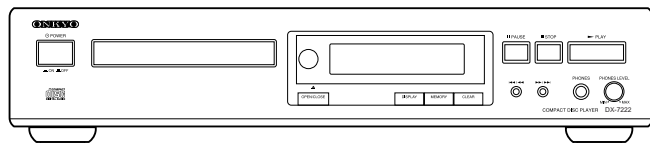

Thank you for purchasing the Onkyo CD player. Please read this manual thoroughly before making connections and plugging in the unit. Following the instructions in this manual will enable you to obtain optimum performance and listening enjoyment from your new CD player. Please retain this manual for future reference.

## Contents

### Before using

Important Safeguards.....	2
Precautions .....	3
Features.....	4
Supplied accessories.....	4
Before operating this unit .....	5
System connections .....	6

### Operation

Playing CDs.....	7
Using the memory function .....	10
Useful Functions.....	12

### Other informations

Control positions and names .....	14
Precautions for handling the Compact Disc (CD) .....	15
Troubleshooting Guide.....	16
Specifications .....	16

### WARNING:

TO REDUCE THE RISK OF FIRE OR ELECTRIC SHOCK, DO NOT EXPOSE THIS APPLIANCE TO RAIN OR MOISTURE.

### CAUTION:

TO REDUCE THE RISK OF ELECTRIC SHOCK, DO NOT REMOVE COVER (OR BACK). NO USER-SERVICEABLE PARTS INSIDE. REFER SERVICING TO QUALIFIED SERVICE PERSONNEL.



**WARNING**  
RISK OF ELECTRIC SHOCK  
DO NOT OPEN

**AVIS**  
RISQUE DE CHOC ELECTRIQUE  
NE PAS OUVRIR



The lightning flash with arrowhead symbol, within an equilateral triangle, is intended to alert the user to the presence of uninsulated "dangerous voltage" within the product's enclosure that may be of sufficient magnitude to constitute a risk of electric shock to persons.



The exclamation point within an equilateral triangle is intended to alert the user to the presence of important operating and maintenance (servicing) instructions in the literature accompanying the appliance.

## Important Safeguards

- 1. Read Instructions** – All the safety and operating instructions should be read before the appliance is operated.
- 2. Retain Instructions** – The safety and operating instructions should be retained for future reference.
- 3. Heed Warnings** – All warnings on the appliance and in the operating instructions should be adhered to.
- 4. Follow Instructions** – All operating and use instructions should be followed.
- 5. Water and Moisture** – The appliance should not be used near water – for example, near a bathtub, washbowl, kitchen sink, laundry tub, in a wet basement, or near a swimming pool, and the like.
- 6. Carts and Stands** – The appliance should be used only with a cart or stand that is recommended by the manufacturer.  

PORTABLE CART WARNING



S3125A
- 6A. An appliance and cart combination** should be moved with care. Quick stops, excessive force, and uneven surfaces may cause the appliance and cart combination to overturn.
- 7. Wall or Ceiling Mounting** – The appliance should be mounted to a wall or ceiling only as recommended by the manufacturer.
- 8. Ventilation** – The appliance should be situated so that its location or position does not interfere with its proper ventilation. For example, the appliance should not be situated on a bed, sofa, rug, or similar surface that may block the ventilation openings; or if placed in a built-in installation, such as a bookcase or cabinet that may impede the flow of air through the ventilation openings, there should be free space of at least 5 cm (2 in.) and an opening behind the appliance.
- 9. Heat** – The appliance should be situated away from heat sources such as radiators, heat registers, stoves, or other appliances (including amplifiers) that produce heat.
- 10. Power Sources** – The appliance should be connected to a power supply only of the type described in the operating instructions or as marked on the appliance.
- 11. Polarization** – If the appliance is provided with a polarized plug having one blade wider than the other, please read the following information:  
The polarization of the plug is a safety feature. The polarized plug will only fit the outlet one way. If the plug does not fit fully into the outlet, try reversing it. If there is still trouble, the user should seek the services of a qualified electrician. Under no circumstances should the user attempt to defeat the polarization of the plug.
- 12. Power-Cord Protection** – Power-supply cords should be routed so that they are not likely to be walked on or pinched by items placed upon or against them, especially near plugs, convenience receptacles, and the point where they exit from the appliance.
- 13. Cleaning** – The appliance should be cleaned only as recommended by the manufacturer.
- 14. Nonuse Periods** – The power cord of the appliance should be unplugged from the outlet when left unused for a long period of time.
- 15. Object and Liquid Entry** – Care should be taken so that objects do not fall and liquids are not spilled into the enclosure through openings.
- 16. Damage Requiring Service** – The appliance should be serviced by qualified service personnel when:  
A. The power-supply cord or the plug has been damaged; or  
B. Objects have fallen, or liquid has been spilled into the appliance; or  
C. The appliance has been exposed to rain; or  
D. The appliance does not appear to operate normally or exhibits a marked change in performance; or  
E. The appliance has been dropped, or the enclosure damaged.
- 17. Servicing** – The user should not attempt to service the appliance beyond that described in the operating instructions. All other servicing should be referred to qualified service personnel.

This unit contains a semiconductor laser system and is classified as a "CLASS 1 LASER PRODUCT". So, to use this model properly, read this Instruction Manual carefully. In case of any trouble, please contact the store where you purchased the unit. To prevent being exposed to the laser beam, do not try to open the enclosure.

### DANGER:

INVISIBLE LASER RADIATION WHEN OPEN AND INTER-LOCK FAILED OR DEFEATED. AVOID DIRECT EXPOSURE TO BEAM.

### CAUTION:

THIS PRODUCT UTILIZES A LASER. USE OF CONTROLS OR ADJUSTMENTS OR PERFORMANCE OF PROCEDURES OTHER THAN THOSE SPECIFIED HEREIN MAY RESULT IN HAZARDOUS RADIATION EXPOSURE.

### For European model:



This label on the rear panel states that:

- This unit is a CLASS 1 LASER PRODUCT and employs a laser inside the cabinet.
- To prevent the laser from being exposed, do not remove the cover. Refer servicing to qualified personnel.

# Precautions

## For U.S. model

The laser is covered by a housing which prevents exposure during operation or maintenance. However, this product is classified as a Laser Product by CDRH (Center for Devices and Radiological Health) which is a department of the Food and Drug Administration. According to their regulations 21 CFR section 1002.30, all manufacturers who sell Laser Products must maintain records of written communications between the manufacturer, dealers and customers concerning radiation safety. If you have any complaints about instructions or explanations affecting the use of this product, please feel free to write to the address on the back page of this manual. When you write us, please include the model number and serial number of your unit.

In compliance with Federal Regulations, the certification, identification and the period of manufacture are indicated on the rear panel.

## FCC INFORMATION FOR USER

### CAUTION:

The user changes or modifications not expressly approved by the party responsible for compliance could void the user's authority to operate the equipment.

### NOTE:

This equipment has been tested and found to comply with the limits for a Class B digital device, pursuant to Part 15 of the FCC Rules. These limits are designed to provide reasonable protection against harmful interference in a residential installation. This equipment generates, uses and can radiate radio frequency energy and, if not installed and used in accordance with the instructions, may cause harmful interference to radio communications. However, there is no guarantee that interference will not occur in a particular installation. If this equipment does cause harmful interference to radio or television reception, which can be determined by turning the equipment off and on, the user is encouraged to try to correct the interference by one or more of the following measures:

- Reorient or relocate the receiving antenna.
- Increase the separation between the equipment and receiver.
- Connect the equipment into an outlet on a circuit different from that to which the receiver is connected.
- Consult the dealer or an experienced radio/TV technician for help.

## For Canadian model

**CAUTION:** THIS DIGITAL APPARATUS DOES NOT EXCEED THE CLASS B LIMITS FOR RADIO NOISE EMISSION FROM DIGITAL APPARATUS SET OUT IN THE RADIO INTERFERENCE REGULATIONS OF THE CANADIAN DEPARTMENT OF COMMUNICATIONS.

For models having a power cord with a polarized plug:

**CAUTION:** TO PREVENT ELECTRIC SHOCK, MATCH WIDE BLADE OF PLUG TO WIDE SLOT, FULLY INSERT.

## Modele pour les Canadien

**ATTENTION:** L'INTERFÉRENCE RADIO ÉLECTRIQUE GÉNÉRÉE PAR CET APPAREIL NUMÉRIQUE DE TYPE B NE DÉPASSE PAS LES LIMITES ÉNONCÉES DANS LE RÈGLEMENT SUR LES PERTURBATIONS RADIO ÉLECTRIQUES, SECTION APPAREIL NUMÉRIQUE, DU MINISTÈRE DES COMMUNICATIONS.

Sur les modèles dont la fiche est polarisée:

**ATTENTION:** POUR ÉVITER LES CHOCS ÉLECTRIQUES, INTRODUIRE LA LAME LA PLUS LARGE DE LA FICHE DANS LA BORNE CORRESPONDANTE DE LA PRISE ET POUSSER JUSQU'AU FOND.

## For British model

Replacement and mounting of an AC plug on the power supply cord of this unit should be performed only by qualified service personnel.

### IMPORTANT

The wires in the mains lead are coloured in accordance with the following code:

Blue : Neutral

Brown : Live

As the colours of the wires in the mains lead of this apparatus may not correspond with the coloured markings identifying the terminals in your plug, proceed as follows:

The wire which is coloured blue must be connected to the terminal which is marked with the letter N or coloured black.

The wire which is coloured brown must be connected to the terminal which is marked with the letter L or coloured red.

### IMPORTANT

A 5 amp fuse is fitted in this plug. Should the fuse need to be replaced, please ensure that the replacement fuse has a rating of 5 amps and that it is approved by ASTA or BSI to BS1362. Check for the ASTA mark or the BSI mark on the body of the fuse.

**IF THE FITTED MOULDED PLUG IS UNSUITABLE FOR THE SOCKET OUTLET IN YOUR HOME, THEN THE FUSE SHOULD BE REMOVED AND THE PLUG CUT OFF AND DISPOSED OF SAFELY. THERE IS A DANGER OF SEVERE ELECTRICAL SHOCK IF THE CUT OFF PLUG IS INSERTED INTO ANY 13 AMP SOCKET.**

If in any doubt, please consult a qualified electrician.

## Declaration of Conformity

We, ONKYO EUROPE  
ELECTRONICS GmbH  
INDUSTRIESTRASSE 20  
82110 GERMERING,  
GERMANY



declare in own responsibility, that the ONKYO product described in this instruction manual is in compliance with the corresponding technical standards such as EN60065, EN55013, EN55020 and EN61000-3-2, -3-3 (or EN60555-2, -3)

GERMERING, GERMANY

K. OTSU

ONKYO EUROPE ELECTRONICS GmbH

# Precautions

## 1. Warranty Claim

You can find the serial number on the rear panel of this unit. In case of warranty claim, please report this number.

## 2. Recording Copyright

Recording of copyrighted material for other than personal use is illegal without permission of the copyright holder.

## 3. Power

### WARNING

BEFORE PLUGGING IN THE UNIT FOR THE FIRST TIME, READ THE FOLLOWING SECTION CAREFULLY.

The voltage of the available power supply differs according to country or region. Be sure that the power supply voltage of the area where this unit will be used meets the required voltage (e.g., AC 230 V, 50 Hz or AC 120 V, 60 Hz) written on the rear panel.

Worldwide models are equipped with a voltage selector to conform to local power supplies. Be sure to set this switch to match the voltage of the power supply in your area before plugging in the unit.

## 4. Do not touch this unit with wet hands

Do not handle this unit or power cord when your hands are wet or damp. If water or any other liquid enters the case, take this unit to an authorized service center for inspection.

## 5. Location of this unit

Place this unit in a well-ventilated location.

Take special care to provide plenty of ventilation on all sides of this unit especially when it is placed in an audio rack. If ventilation is blocked, this unit may overheat and malfunction.

Do not expose this unit to direct sunlight or heating units as this unit's internal temperature may rise and shorten the life of the pickup.

Avoid damp and dusty places and places directly affected by vibrations from the speakers. In particular, avoid placing the unit on or above one of the speakers.

Be sure this unit is placed in a horizontal position. Never place it on its side or on a slanted surface as it may malfunction.

Do not place near tuners or TV sets.

If placed next to a TV or tuner, it may cause reception interference resulting in some noise in the TV or tuner output.

## 6. Care

From time to time you should wipe the front and rear panels and the cabinet with a soft cloth. For heavier dirt, dampen a soft cloth in a weak solution of mild detergent and water, wring it out dry, and wipe off the dirt. Following this, dry immediately with a clean cloth.

Do not use rough material, thinners, alcohol or other chemical solvents or cloths since these could damage the finish or remove the panel lettering.

## 7. Points to remember

If this unit is brought from a cold environment to a warm one or is in a cold room that is quickly heated, condensation may form on the pickup, preventing proper operation. In this case, remove the disc and leave the power ON for about one hour to remove the condensation.

When transporting this unit, be careful not to bump it.

# Features

## ■ 36-Track Random Memory (Remote controller only)

## ■ 8-times oversampling digital filter

## ■ Shuffle play (Remote controller only)

## ■ 20-track music calendar

## ■ Time edit (calculates number of tracks that will fit on a cassette) (Remote controller only)

## ■ 10-key direct track access (Remote controller only)

## ■ Headphone jack with volume control

## ■ Peak search (Remote controller only)

## ■ Memory and Memory reverse

A convenient feature that lets you easily eliminate tracks you don't want to hear or record.

## ■ Next selection (Remote controller only)

## ■ Five mode repeat function: entire side, single track, A-B, memory and shuffle

## ■ Two optical digital outputs

## ■ RI Compatible Remote Control Supplied

### Memory Preservation

This unit does not require memory preservation batteries. A built-in memory power back-up system preserves the contents of the memory during power failures and even when the POWER switch is set to off. The POWER switch must be set to on in order to charge the back-up system.

The memory preservation period after the unit has been turned off varies depending on climate and placement of the unit. On the average, memory contents are protected over a period of a few weeks after the last time the unit has been turned off. This period is shorter when the unit is exposed to a highly humid climate.

# Supplied accessories

Check that the following accessories are supplied with this unit.

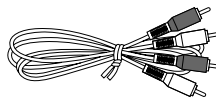

Audio connection cable × 1

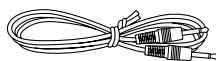

RI cable × 1

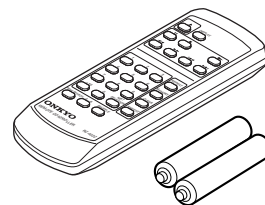

Remote controller × 1  
Batteries (size AA, R6 or UM-3) × 2

# Before operating this unit

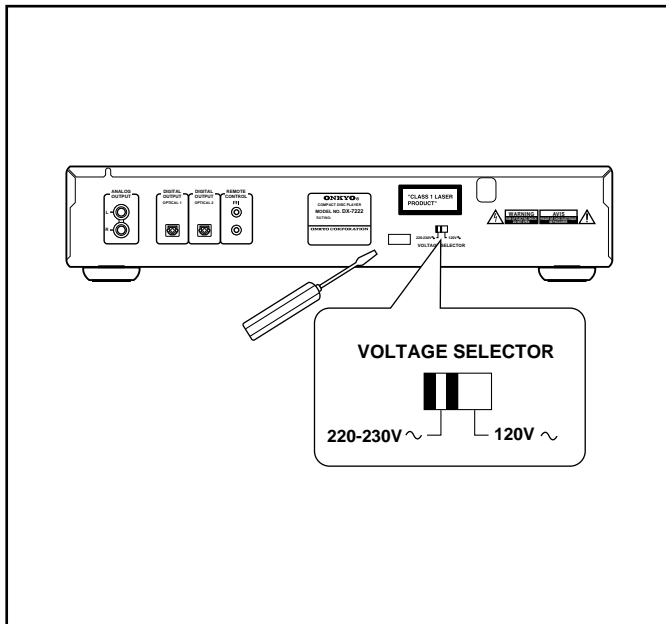

## Setting the Voltage selector (Worldwide models only)

Worldwide models are equipped with a voltage selector to conform with local power supplies. Be sure to set this switch to match the voltage of the power supply in your area before plugging in the unit.

1. Determine the proper voltage for your area: 220-230 V or 120 V.
2. If the preset voltage is not correct for your area, insert a screwdriver into the groove in the switch. Slide the switch all the way to the right (120 V) or to the left (220-230 V), whichever is appropriate.

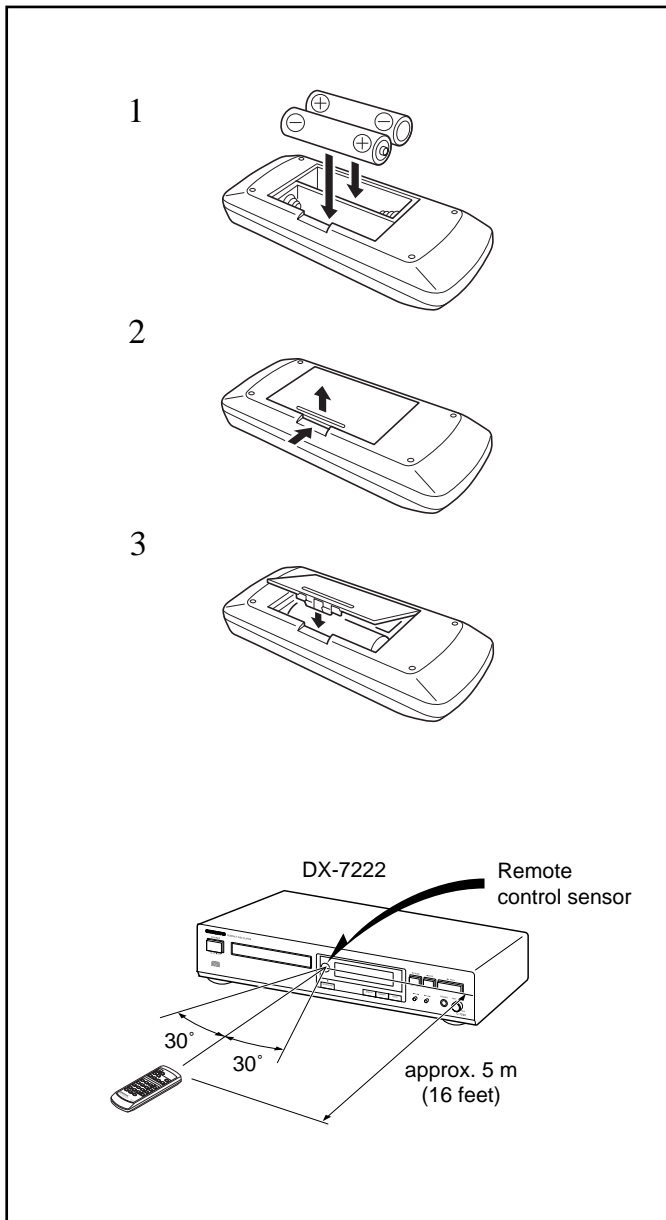

## Installing the remote controller batteries

1. Remove the battery compartment cover by opening it as shown in the illustration.
2. Insert two AA (R6- or UM-3)-size batteries into the battery compartment. Carefully follow the polarity diagram (positive (+) and negative (-) symbols) inside the battery compartment.
3. After batteries are installed and seated correctly, replace the compartment cover.

### Notes

- Do not mix new batteries with old batteries or different kinds of batteries.
- To avoid corrosion, remove the batteries if the remote controller is not to be used for a long time.
- Remove dead batteries immediately to avoid damage from corrosion. If the remote controller doesn't operate smoothly, replace both the batteries at the same time.
- The life of the batteries supplied is about six months but this will vary depending on usage.

## Using the remote controller

Point the remote controller toward the remote control sensor.

### Notes

- Place the unit away from strong light such as direct sunlight or inverted fluorescent light which can prevent proper operation of the remote controller.
- Using another remote controller of the same type in the same room or using the unit near equipment which uses infrared rays may cause operational interference.
- Do not put any object such as a book on the remote controller. The buttons of the remote controller may be pressed by mistake and drain the batteries.
- Make sure the audio rack doors do not have colored glass. Placing the unit behind such doors may prevent proper remote controller operation.
- If there is any obstacle between the remote controller and the remote control sensor, the remote controller will not operate.

# System connections

## Connecting other components

- Do not plug in the AC power cord until all other connections have been made.
- On each pair of input or output jacks, the jack marked R corresponds to the right channel, and the jack marked L to the left channel. Refer to the amplifier's instruction manual for further information on connections.
- Avoid bundling the audio connection cables with the power cord or speaker cables. Doing so may degrade sound reproduction.
- Insert the plugs and connectors securely. Remember that improper connection can result in noise, poor performance, or damage to the equipment.

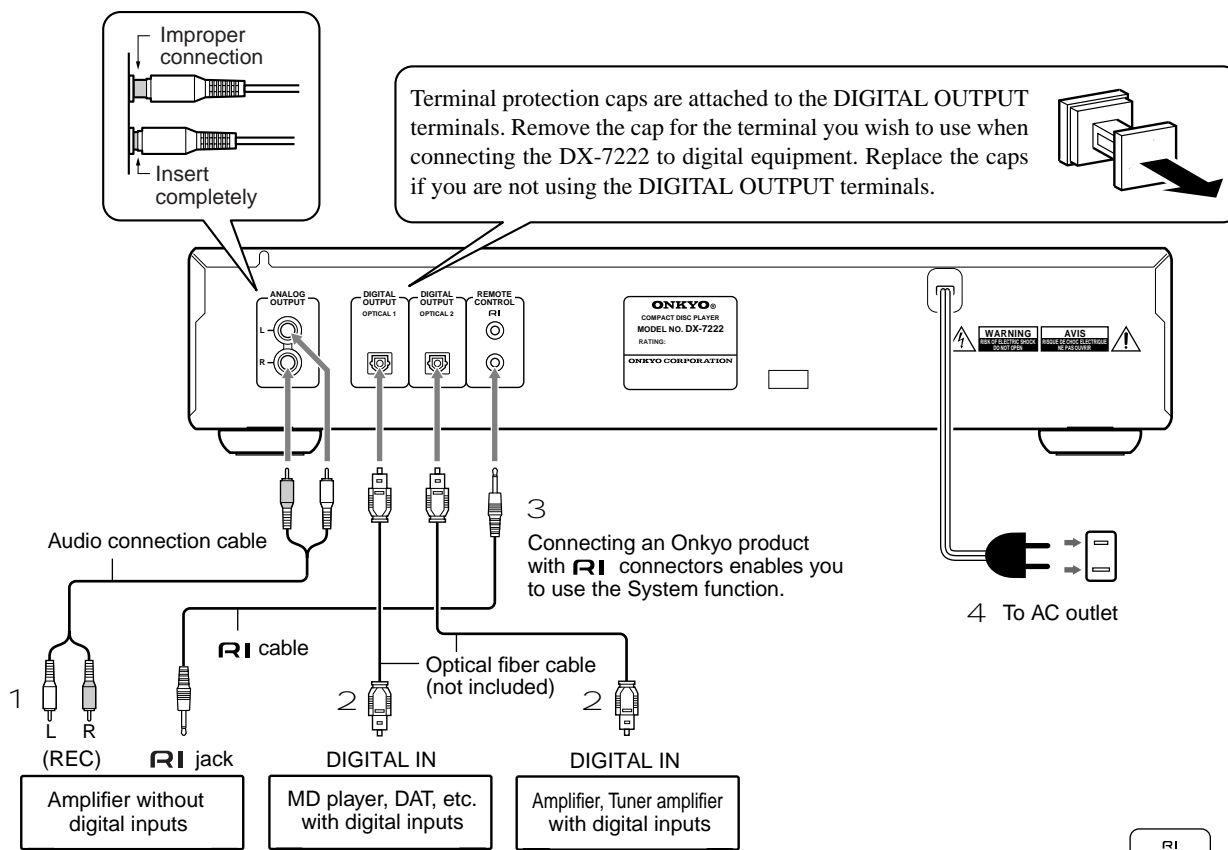

### A Connection with the amplifier

Connect the DX-7222 to the CD jacks of your amplifier.

### B Connection via the digital output terminal (DIGITAL OUTPUT)

Connection to digital equipment, such as an MD recorder or DAT.

Use an optical cable to connect this unit to the digital input terminal of an MD recorder or DAT in order to make digital recordings. The optical cable should have connectors which fit into the digital terminals.

### C Connections for remote control

When the DX-7222 is connected to an amplifier with the Onkyo RI jack, pressing the CD operation button on the amplifier's remote controller enables you to operate the CD player.

#### Note:

- The upper and lower RI remote control jacks have the same function.
- Remote control operation is not possible when only the remote control cable is connected – the audio cables must also be connected.
- An RI cable equipped with a 1/8" (3.5mm) diameter miniature two-conductor phone plug is included with the DX-7222 and with every tuner, compact disc player or cassette tape deck with the RI symbol.

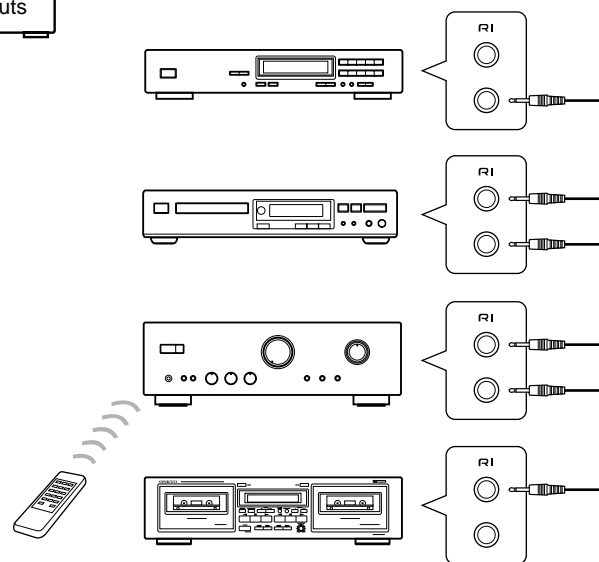

### D Connecting the AC power cord and turning the power on

1. Insert the AC power cord into a wall outlet.

2. Press the POWER ON/OFF button.

The display will light.

#### Note:

To insert the AC power cord into an AC outlet on the rear panel of another component, use the UNSWITCHED outlet.

# Playing CDs

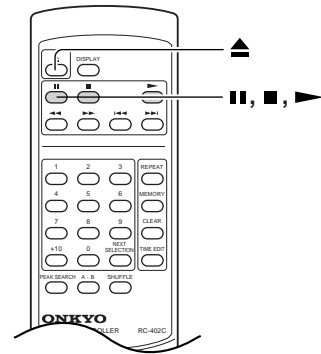
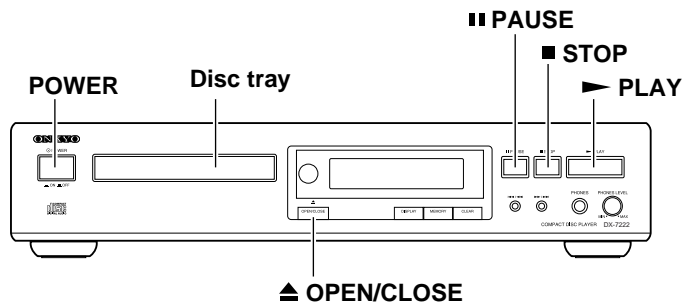

**1**

**2**

**3**

**4**

**5**

**Remote controller**

**Label side**

**Remote controller**

**Remote controller**

## Normal play

1. Press the **POWER** button to turn on the power.
  2. Press the **▲ OPEN/CLOSE** button.
  3. Put the disc in the disc tray, with the label side of the disc facing up.
  4. Press the **▲ OPEN/CLOSE** button.
  5. Press the **▶ PLAY** button.
- The CD player will play the first track (track 1).  
 \* If you want to, you can skip step 4 by pressing the **▶ PLAY** button instead of the **▲ OPEN/CLOSE** button. The disc tray will close automatically and play track 1.

If the CD player does not start playing when the **▶ PLAY** button is pressed:

- The disc may be upside down in the tray. Press the **▲ OPEN/CLOSE** button to open the disc tray. If you cannot read the label on the disc, turn the disc over.
- Moisture may have formed inside the CD player. Remove the disc from the disc tray and leave the power on for about one hour to evaporate the moisture.

## Using the timer for play

The CD player starts playing the loaded CD automatically as soon as power is supplied. Using this feature, you can enjoy timer play using your audio timer. For instructions on how to set the timer, see the instruction manual supplied with the timer.

## Contents of the display

- **Before starting play after you have inserted a disc**
    - (a) The total number of tracks on the disc
    - (b) All of the track numbers on the disc (When the number of tracks exceeds 20, the OVER indicator lights.)
    - (c) The total playing time of the disc
  - **After starting play**
    - (d) The track number currently being played
    - (e) The next track number
    - (f) The elapsed time of the current track
- The display can be changed by pressing the **DISPLAY** button.

**Remote controller**

## Stopping play

Press the **■ STOP** button.

**Remote controller**

**PAUSE**

## Stopping play temporarily

Press the **|| PAUSE** button.  
 The **PAUSE** indicator will light.  
 To resume play, press the **▶ PLAY** button or the **|| PAUSE** button. The **PAUSE** indicator will turn off.





# Playing CDs

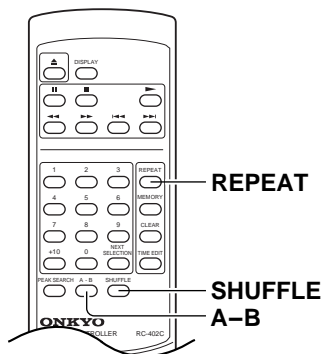

<p><b>Remote controller</b></p>
<p><b>Remote controller</b></p>
<p><b>1</b></p> <p><b>Remote controller</b></p>
<p><b>2</b></p> <p><b>Remote controller</b></p>

**Remote controller**

## Repeating play (Remote controller only)

Press the REPEAT button to enter the repeat play mode. Repeat play can be used in conjunction with normal, memory, and shuffle play modes.

### Full repeat (Repeating all tracks on a disc)

Press the REPEAT button once.

### During normal play

When the last track on the CD finishes, the CD player starts playing from the first track on the CD.

### During memory play

When the last track in memory finishes, the CD player starts playing from the first track in memory.

### During shuffle play

When the last track in shuffle play finishes, the CD player starts playing the CD again, in a different order.

- Press the REPEAT button to cancel repeat play. The REPEAT indicator will turn off.

### Single repeat

Press the REPEAT button twice.

### Before starting play

The CD player will play the first track repeatedly.

### During play

The CD player will play the current track repeatedly.

- Press the REPEAT button to cancel repeat play. The REPEAT indicator will turn off.

### Block repeat (Repeating a block of music)

You can repeatedly play a part between the start and end points specified with the A-B button.

Follow the procedure below while a CD is playing.

1. Press the A-B button at the beginning of the block repeat. (Point A)
  2. Press the A-B button at the end of the block repeat. (Point B)
- The section between A and B will be played repeatedly.

### Note:

You can specify A and B points beyond a track.

This function is not available during memory play, repeat play (full repeat and single repeat), shuffle play, and time edit play.

- Press the A-B button once again to cancel block repeat play.

## Shuffle play

Press the SHUFFLE button.

In shuffle play mode, the CD player will play the tracks in random order.

- The auto space function will insert 3 seconds of blank time between tracks during shuffle play. Play automatically begins.
- This function can be used in memory mode. In this case, the programmed tracks are played at random.

Press the SHUFFLE button to cancel shuffle play. The SHUFFLE indicator will turn off.

### Note:

In shuffle play repeat mode, when all of the tracks have been played once, play will be repeated with a different track progression.

# Using the memory function

- Up to 36 tracks can be stored in memory.

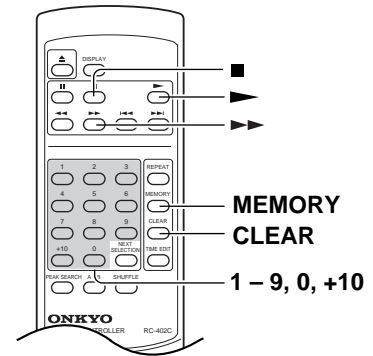
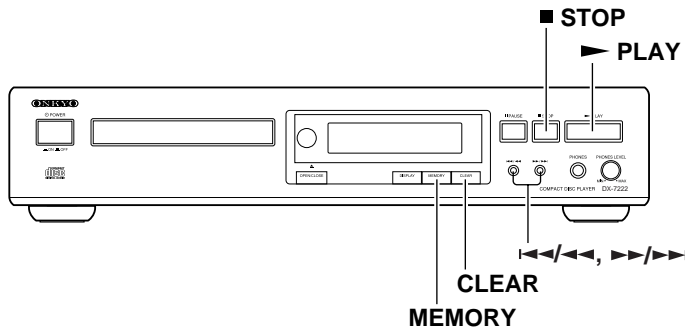

**1**

**2**

**3**

## Storing a program into memory and playing it

- Press the **MEMORY** button.
- Select the desired track number, using the **◀◀** and **▶▶** buttons and press the **MEMORY** button.  
To enter further track numbers into memory, repeat this procedure. You can store maximum of 36 tracks in memory.  
\* If you use the remote controller, press the number buttons to select the desired track.
- When you press the **▶ PLAY** button, the CD player will play the tracks in the order you selected.

### Note:

- If more than 36 tracks are selected, "FL" will flash in the memory channel display area to indicate that the memory is full.
- If the **MEMORY** button is pressed during play, the current track being played is stored in memory.

## Contents of the display

**Example:** After storing tracks 2, 3, 5, 6, 9 and 12 in memory.

- Before starting play**
  - Ⓐ The selected track numbers
  - Ⓑ Memory channel
  - Ⓒ The total playing time of selected tracks
- During play**
  - Ⓓ Track number 2 is currently being played (the first track in memory).
  - Ⓔ Next track number in memory
  - Ⓕ Time elapsed in track currently playing
  - Ⓖ The remaining track numbers in memory

## Stopping a memory play

Press the **■ STOP** button.

## Using the memory function

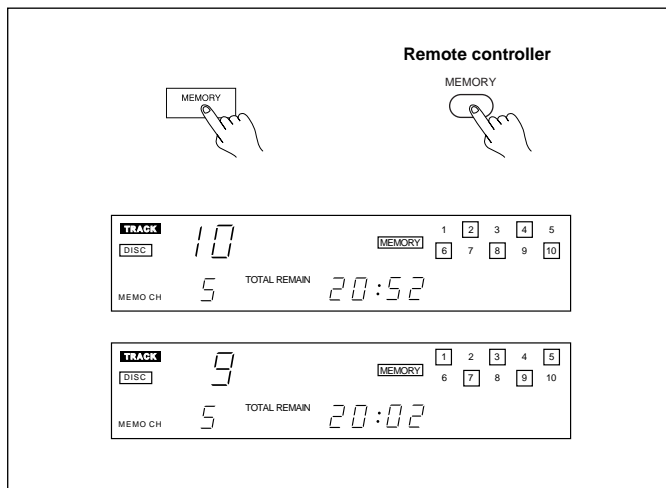

### Memory reverse function

When track numbers 2, 4, 6, 8 and 10 have been stored in memory, **Press the MEMORY button.**

All tracks which have not been stored in memory will be stored in memory, replacing the previous contents. When you press the ► PLAY button, the CD player will start playing.

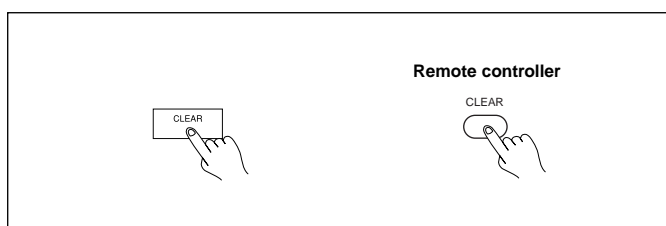

### Clearing the last track stored

**Press the CLEAR button.**

The last track programmed in memory is cleared.

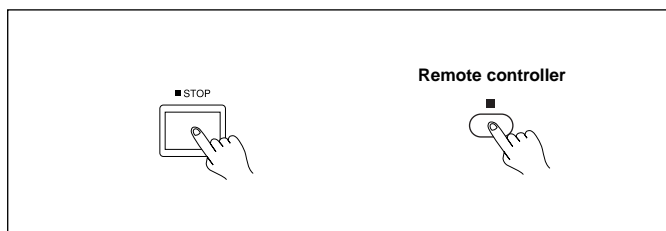

### Canceling the memory play

**Press the ■ STOP button while the CD player is in stop mode.** The contents of the memory are completely cleared.

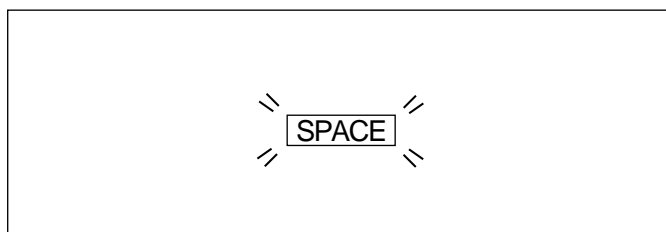

### SPACE indicator

A 3-second silence will be automatically added between tracks during memory play (the SPACE indicator will flash). However, during normal sequential play this space will not be inserted.

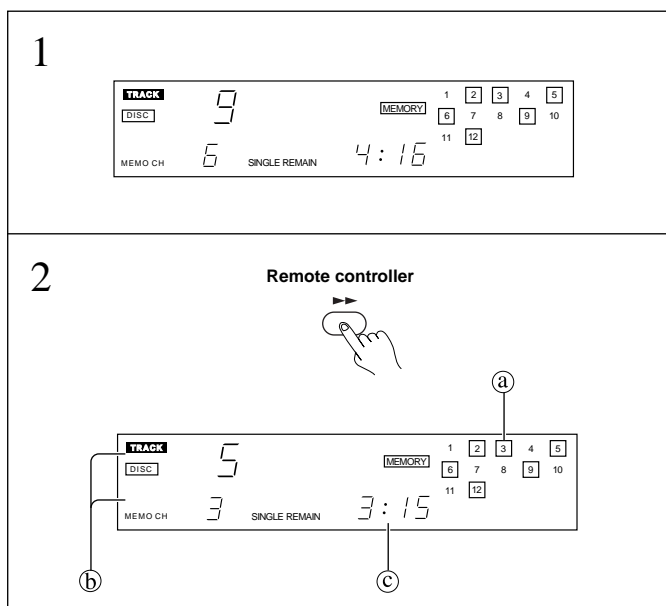

### Checking what is stored in memory

**1. When the CD player stops during memory play, the last program number stored in memory will be shown in the display.**

**2. When you press the ►► button, the display will show each track number stored in memory, in turn.**

- Ⓐ The selected track numbers
- Ⓑ Memory channel and stored track number in memory channel
- Ⓒ The playing time of track

# Useful Functions

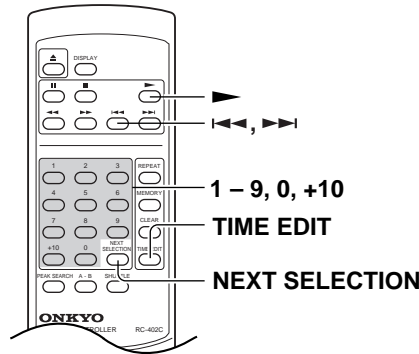

**1** Remote controller  
NEXT SELECTION

**2** Remote controller

1	2	3
4	5	6
7	8	9
+10	0	

## Selecting the next track for play

1. During playback, press the NEXT SELECTION button.
2. While the “- -” is flashing, select the next desired track using the number buttons and the +10 button.

After playing the current track, the selected track will be played.

### Note:

The Memory Play or the Shuffle Play mode, if appropriate, will be canceled before the playing of the specified track begins.

**1** Remote controller  
TIME EDIT

Remote controller

or

1	2	3
4	5	6
7	8	9
+10	0	

**2** Remote controller

**3** Remote controller

## Time edit function

This function can be used when recording from a CD to a cassette tape. Make sure that you cancel the memory mode before using this function.

1. Press the TIME EDIT button.

- Pressing this button will change the Track Number display from 46 → 50 → 54 → 60 → 70 → 80 → 90 → 46 → .....

These numbers indicate the length of the tape.

- (a) Tape length.
- (b) The track numbers to be recorded onto side A will be displayed in a box.
- (c) This is the total time for the tracks on side A. This changes to the display for side B (B) after 2 or 3 seconds. Pressing the DISPLAY button will show the display for the A side again.
- Each time the skip buttons are pressed, the tape length will change by 1 minute.
- Use number buttons and + 10 button to directly enter the length of the tape.  
The maximum setting is 99 minutes.

2. Press the ► PLAY button.

The CD player starts playing from the first track on the disc to be recorded onto side A.

When the last track on side A is completed, the pause mode is automatically set.

3. Press the ► PLAY button again.





The pause mode is canceled and the CD player starts playing the remaining tracks for recording onto side B.

### Note:

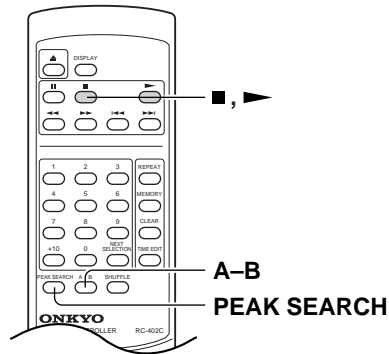
- The time edit mode does not function for discs with more than 20 tracks, or when the first track is longer than half the indicated length of the tape.
- During time edit play, buttons other than STOP, OPEN/CLOSE, and DISPLAY cannot be used for input.

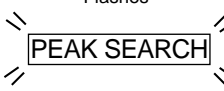
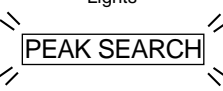
# Useful Functions



1	<p>Remote controller</p>  <p>PEAK SEARCH</p>
	<p>Flashes</p>  <p>→</p> <p>Lights</p> 
2	<p>Remote controller</p>  <p>A - B</p>
3	<p>Remote controller</p>  <p>▶</p>
4	<p>Remote controller</p>  <p>■</p>

## Peak search

This function searches for the peak sound level on the disc. When using the memory mode, press the MEMORY button to return to normal mode.

### 1. Press the PEAK SEARCH button.

- The CD player checks the disc for the highest sound level. The PEAK SEARCH indicator will flash during this operation. When the search is complete, the indicator will light.

### 2. Press the A-B button.

“P” appears in the memory channel display area and flashes.

### 3. Press the ▶ PLAY button.

- The section of the disc with the highest sound level will be played repeatedly for 6 seconds. Refer to this level when recording the disc onto a cassette tape.

### 4. Press the ■ STOP button.

The CD player stops.

- This level is stored until the

▲ OPEN/CLOSE button is pressed or the power is turned off. To repeat the 6-seconds playback of the peak level, follow steps 2, 3, and 4 when the CD player is stopped.

- Pressing the PEAK SEARCH button will turn off the PEAK SEARCH indicator and the level will be cleared from the memory.

- Pressing the A-B button after pressing the ▶ PLAY button will start the block repeat operation.

### Note:

Depending on the disc playing, memorizing of a level which is not the maximum audible level could occur. This is due to the CD player's microprocessor memorizing inaccurate information because of flaws in the disc itself, or recording conditions. Under such circumstances, the recording level for the cassette tape may be very low, or else distortion or similar symptoms could arise on account of excessively high signal levels. To avoid this, be sure to reset the recording level of the cassette deck if such symptoms occur.

# Control positions and names

## Note:

If there is a protective film on the surface of the display, making it difficult to read the display, remove it.

For more information about the function of a particular button, please turn to the page listed in the brackets ([ ]) following each name.

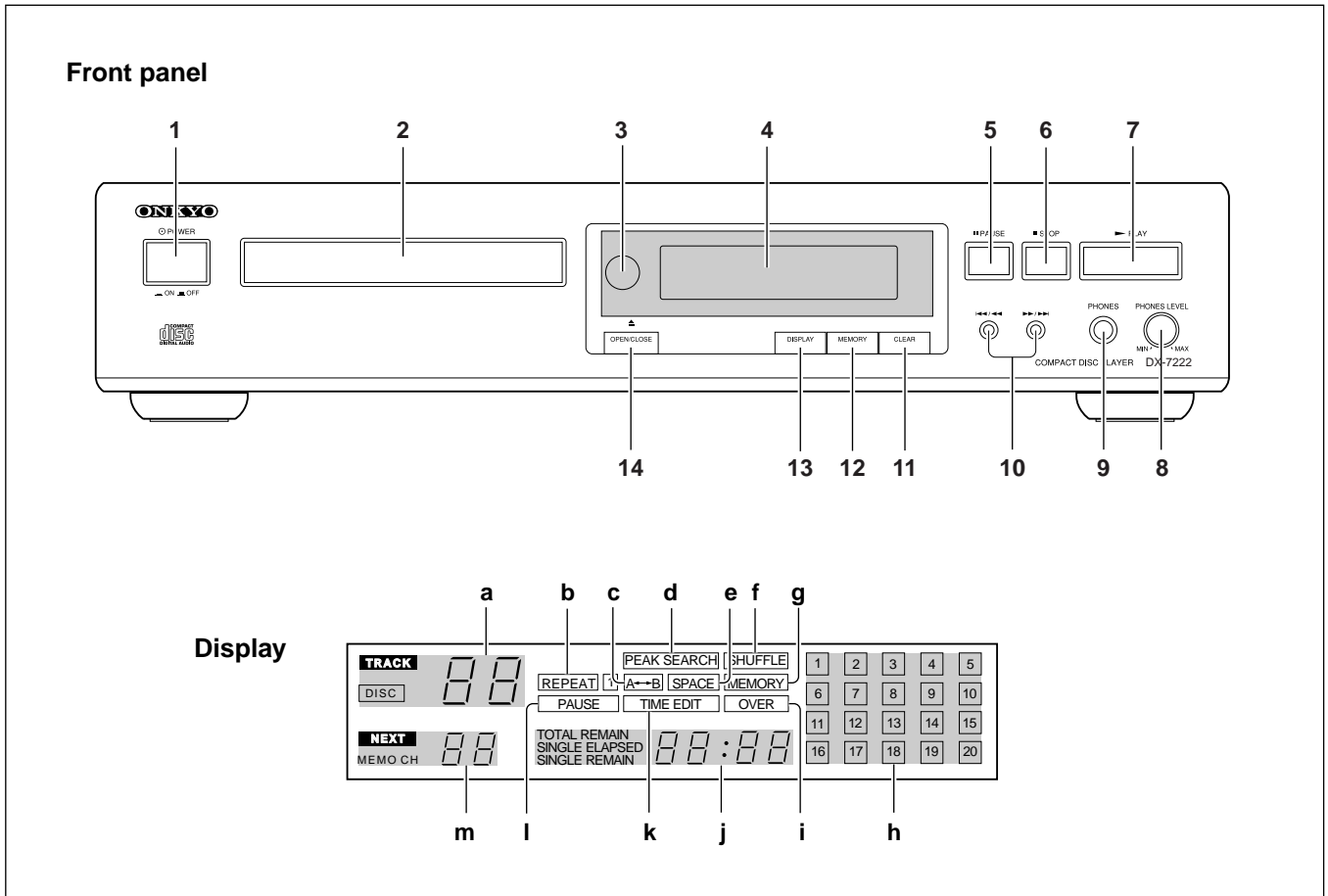

## Front panel

1. POWER button [7]
2. Disc tray [7]
3. Remote control sensor [5]
4. Display (Refer to the "Display" illustration.)
5. PAUSE button [7]
6. STOP button [7, 11]
7. PLAY button [7, 10]
8. PHONES LEVEL knob [8]
9. PHONES jack [8]
10. Skip/Search buttons [8, 10]
11. CLEAR button [11]
12. MEMORY button [10, 11]
13. DISPLAY button [8]
14. OPEN/CLOSE button [7]

## Display

- a. Track number display
- b. REPEAT indicator
- c. Block repeat indicator
- d. PEAK SEARCH indicator
- e. SPACE indicator
- f. Shuffle play indicator
- g. MEMORY indicator
- h. Music calendar display
- i. OVER indicator [7]
- j. Time display
- k. TIME EDIT indicator
- l. PAUSE indicator
- m. Next track number/memory channel display

## Control positions and names

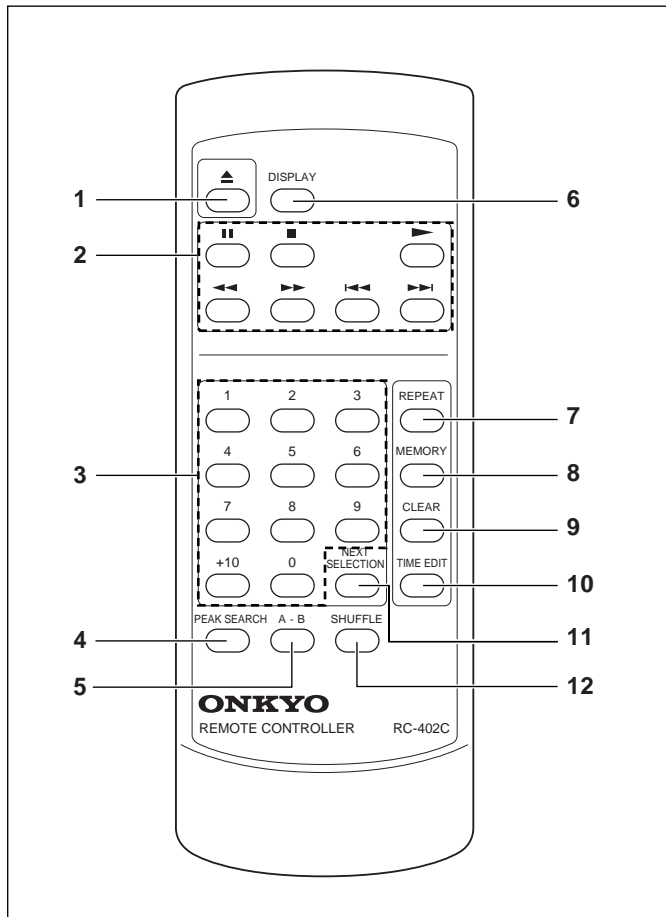

### Remote controller

1. Open/Close button [7]
2. CD operation buttons
  - ▬ : Pause button [7]
  - : Stop button [7, 11, 13]
  - ▶ : Play button [7, 10, 13, 21]
  - ◀◀ : Fast reverse button [8]
  - ▶▶ : Fast forward button [8, 11]
  - ⏮ : Down button [8, 12]
  - ⏭ : Up button [8, 12]
3. Number buttons and +10 button [8, 10, 12]
4. PEAK SEARCH button [13]
5. A-B button [9, 13]
6. DISPLAY button [8]
7. REPEAT button [9]
8. MEMORY button [10, 11]
9. CLEAR button [11]
10. TIME EDIT button [12]
11. NEXT SELECTION button [12]
12. SHUFFLE button [9]

## Precautions for handling the Compact Disc (CD)

### Important note on handling CDs

1. Carefully lift the disc from the disc case, making sure to hold the disc by its edges or the hole in the middle.

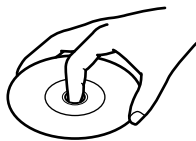

2. A dry, soft cloth may be used to wipe dust and fingerprints off the surface of CDs.

Do not use volatile agents on discs, such as thinner or benzene. Also, do not use conventional record cleaner or anti-static agents.



- Do not place a CD in direct sunlight or locations subject to high humidity or low temperature.
- Do not store a CD in this unit tray for a long period of time.

### Playable discs

This unit can play back the following discs.

	Disc mark	Contents	Disc size	Maximum playback time
Audio CDs	COMPACT disc DIGITAL AUDIO	Audio	12 cm	74 minutes
			8 cm (CD single)	20 minutes

You cannot play back discs other than those listed above. Do not use discs that are not audio discs (e.g. CD-ROMs for use with personal computers), as these could damage the speakers and amplifier.

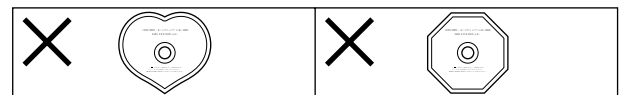

Avoid using heart-shaped or octagonal discs. Playing irregularly shaped discs may damage the internal mechanism of the unit.

Do not use discs on which adhesive from adhesive tape or a disc label (if it is a rental disc) remains.

Otherwise, you may not be able to eject the discs or the unit may become inoperative.

# Troubleshooting Guide

- **No power.**  
*Cause:* Power cable is not properly plugged into the AC outlet.  
*Remedy:* Insert the power plug firmly.
- **A disc is loaded in the disc tray, but playback will not start.**  
*Cause:* A disc in the disc tray may be upside down.  
*Remedy:* Load the disc with the label facing upward.  
*Cause:* The disc is dirty.  
*Remedy:* Clean the disc.  
*Cause:* Moisture has accumulated inside the CD changer.  
*Remedy:* Remove the disc from the disc tray, place the CD changer in a warm place, and leave the power on for about one hour.
- **No sound is heard.**  
*Cause:* Connections may be incomplete or incorrect.  
*Remedy:* Check all cable connections. Insert all the plugs firmly into the jacks.  
*Cause:* The input selector switch on the amplifier may be set incorrectly.  
*Remedy:* Set the switch to the proper position. See your amplifier's operating instructions for more information.
- **Disc playback skips.**  
*Cause:* The disc is dirty.  
*Remedy:* Clean the disc.  
*Cause:* A disc is scratched.  
*Remedy:* Replace the disc.  
*Cause:* The CD changer is subject to being accidentally bumped.  
*Remedy:* Place the CD changer in a more stable location.
- **Search time (when locating a specific track) is extremely long.**  
*Cause:* The disc is dirty.  
*Remedy:* Clean the disc.  
*Cause:* The disc is scratched.  
*Remedy:* Replace the disc.
- **Track numbers cannot be stored in memory.**  
*Cause:* No disc in the tray.  
*Remedy:* Load a disc in the tray.  
*Cause:* You have entered a track number that does not exist on the disc.  
*Remedy:* Use only the track numbers that exist on the disc.
- **Front panel controls function correctly, but remote controller does not.**  
*Cause:* No batteries in remote controller.  
*Remedy:* Insert batteries.  
*Cause:* Batteries have worn out.  
*Remedy:* Replace batteries.

This unit contains a sensitive microcomputer, which under certain circumstances might fail to operate due to excessive noise interference. In such case, switch off the main power by pressing the POWER switch, wait five seconds, then switch it on again.

# Specifications

Signal readout system:	Optical non-contact
Reading rotation: (constant linear velocity)	About 500 - 200 r.p.m.
Linear velocity:	1.2 - 1.4 m/s
Error correction system:	Cross Interleave Reed-Solomon code
D/A converter:	1 bit PWM/ACCUPULSE
Sampling frequency:	352.8 kHz (8 times oversampling)
Number of channels:	2 (stereo)
Frequency response:	5 Hz - 20 kHz
Total harmonic distortion:	0.005% (at 1 kHz)
Dynamic range:	96 dB
Signal to noise ratio:	90 dB
Channel separation:	85 dB (at 1 kHz)
Wow and Flutter:	Below threshold of measurability
Output level:	2 volts r.m.s.
Power consumption:	9 watts
Power supply:	120 V, 60 Hz 230V, 50 Hz 220-230V/120V switchable, 50/60 Hz
Dimensions (W × H × D):	435 × 91 × 308 mm (17-1/8" × 3-9/16" × 12-1/8")
Weight:	3.7 kg (8.2 lbs.)

Specifications and features are subject to change without notice.

## ONKYO CORPORATION

Sales & Product Planning Div. : 2-1, Nisshin-cho, Neyagawa-shi, OSAKA 572-8540, JAPAN  
Tel: 0720-31-8111 Fax: 0720-33-5222 <http://www.onkyo-intl.com>

## ONKYO U.S.A. CORPORATION

18 Park Way, Upper Saddle River, N.J. 07458, U.S.A.  
Tel: 201-785-2600 Fax: 201-785-2650 <http://www.onkyousa.com>

## ONKYO EUROPE ELECTRONICS GmbH

Liegnitzerstrasse 6, 82194 Groebenzell, GERMANY  
Tel: +49-8142-4401-0 Fax: +49-8142-4401-555 <http://www.onkyo.net>

## ONKYO CHINA LIMITED

Units 2102-7, Metroplaza Tower I, 223 Hing Fong Road, Kwai Chung,  
N.T., HONG KONG Tel: 852-2429-3118 Fax: 852-2428-9039 <http://www.onkyochina.com>

