



ENTERPRISE HD IP PHONE



USER GUIDE

UC803(P)

Version:1.0.3.82

Notices Information

Copyright

Copyright © 2005 - 2015 Nanjing Hanlong Technology CO., LTD. All rights reserved.

Nanjing Hanlong Technology Co., LTD. owns all the right to revise and change this document at any time. And all the illustrations and instructions in this paper are subject to the copyright protection of legal law. No parts of this document may be used or reproduced, transmitted by the third parties for any purposes without the express written permission of Nanjing Hanlong Technology Co., LTD.

When this document is made available on www.h-tek.com , Hanlong Technology Co., LTD. gives its right to download and print copies of this content only for private use as a user manual. No parts shall have the right to alter, modify or use as commercial means without the express written permission of Nanjing Hanlong Technology Co., LTD.

Safety cautions

- To use the Phone follow the instructions in this manual.
- To use the power adapter that delivered with the phone. Other power adapters may damage the phone.
- The phone is only for indoor use. And also avoid in high humidity, water and some other liquids.
- Do not use the phone during thunderstorms.
- CE
- FCC

WEEE Warning



To avoid the potential effects on the environment and human health as a result of the presence of hazardous substances in electrical and electronic equipment, end users of electrical and electronic equipment should understand the meaning of the crossed-out wheeled bin symbol. Do not dispose of WEEE as unsorted municipal waste and have to collect such WEEE separately.

Cleaning

To clean the device, use an anti-static cloth. Please avoid cleaning liquids as they might damage the surface or internal electronics of the phone.

Table of Content

Notices Information	1
Copyright	1
Safety cautions	1
WEEE Warning	1
Cleaning	2
Table of Content	3
Getting Started	7
Packing List	7
Phone Installation.....	9
1. Attach the Foot stand.....	9
2. Connect the Handset and optional Headset.....	10
3. Connect the Network and Power.....	11
Initialization	11
Status	12
Registration	14
Idle Screen	16
Getting Familiar with Your Phone.....	17
Hardware Components Preview.....	17
Icon Preview	19
LED Instruction.....	21
Power Indicator LED	21
Line LED:(Line or Memory Key set as Line).....	21
BLF or BLF List Key LED :(Line/Memory Key set as BLF).....	21
Shared Line Key LED :(Line/Memory Key set as Shared Line)	22
Other Key Led.....	22
User Interface.....	22
Memory Key Function Overview	24
Basic Features Configuration	26
Web Login.....	26
Administrator Password.....	27
Basic Network Setting	28
WAN Port.....	29
PC Port.....	31
Language.....	33
Time and Date	34
Ring Tone.....	37
Volume	38
Screen Saver.....	40
Backlight.....	42

Contact Management	43
Local Directory	43
Remote Phonebook	47
Call History	48
LDAP Phonebook	51
Broadsoft Phonebook.....	53
Call log.....	54
Other features settings	55
Dial Plan.....	55
Emergency Call.....	56
LED Status Setting.....	57
Action URL.....	58
Softkey Layout.....	59
Programmable Key	60
Basic Call Features.....	61
Place a Call	61
End a Call.....	63
Receive a Call	63
Incoming Call Show Mode	64
Auto Answer	65
Call Hold.....	65
Call Transfer.....	66
Call Conference.....	70
Call Forward	71
Call Return.....	74
Call Waiting Tone.....	75
Anonymous Call	76
Reject Anonymous	77
Call Mute	77
DND.....	78
Key as Send.....	78
No Key Entry Timeout.....	79
Keypad Lock	80
Hot Line	81
Function Key Features Settings.....	82
Line	82
Speed Dial.....	83
BLF.....	84
BLF List	85
Voice Message.....	87
Direct Pickup	87
Group Pickup	88
Call Park.....	89

Intercom	90
DTMF	92
Prefix.....	93
Local Group	94
XML Group.....	95
LDAP	96
XML Browser	97
Broadsoft Group.....	98
Conference	99
Forward	99
Transfer	100
Hold.....	101
Group Listening	102
DND.....	102
Redial	103
SMS.....	104
Send SMS.....	104
Set SMS Memory Key	105
Record.....	105
URL Record	106
Paging	107
Shared Line	107
Public Hold	109
Private Hold	109
Share line	110
Hot Desking	111
ACD (Pending)	113
Zero Touch	114
Upgrade	115
Factory Reset	115
Pcap Feature.....	115
System Log	116
Upgrade.....	117
Configuration File	119
Troubleshooting.....	120
Why is the phone LCD screen blank?.....	120
Why does the phone display "Network Unavailable"?	120
Why can't I get a dial tone?	121
Where to set the tone?.....	121
How to download XML Configuration?	121
How to Import Trusted CA certificate?.....	121
How to Import Server CA certificate?	122
How to use Vlan?.....	122

How to use LLDP?.....	123
How to Set LCD and Web GUI:	123
How to Upgrade via FTP?	123
How to make Ringtone?.....	123
How to use Open VPN?	123
Provisioning Guide on Free PBX:.....	123
Failover Notes	124
How to Use Auto Provision Phonebook?.....	124
All Documents	124

Getting Started

Packing List

The package contains the following parts, please check if all the items are not missed:

1. The phone device

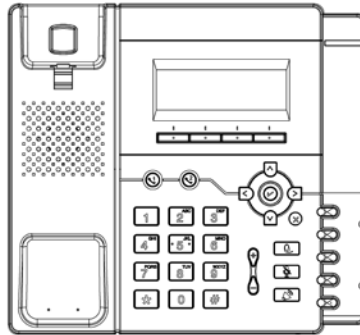

2. The footstand

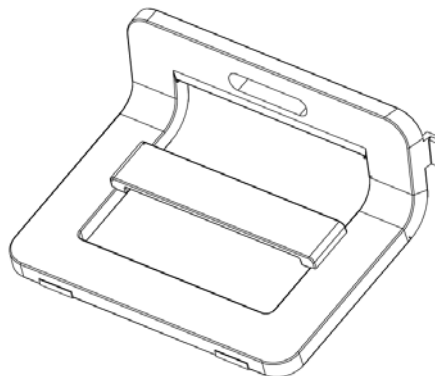

3. Handset



4. Headset cord

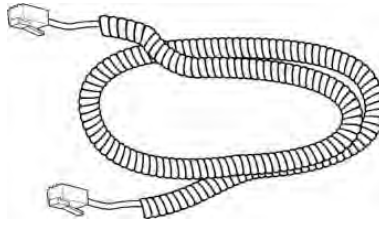

5. Power adapter

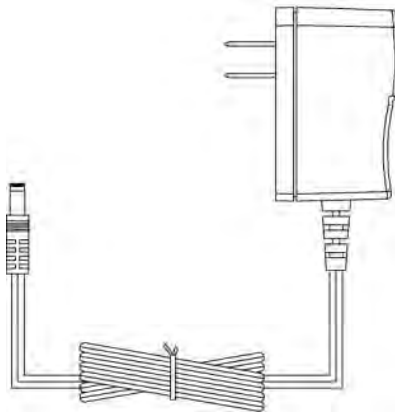

6. Ethernet cable

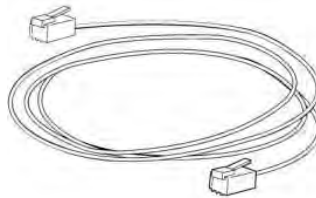

7. Quick installation reference



Phone Installation

1. Attach the Foot stand

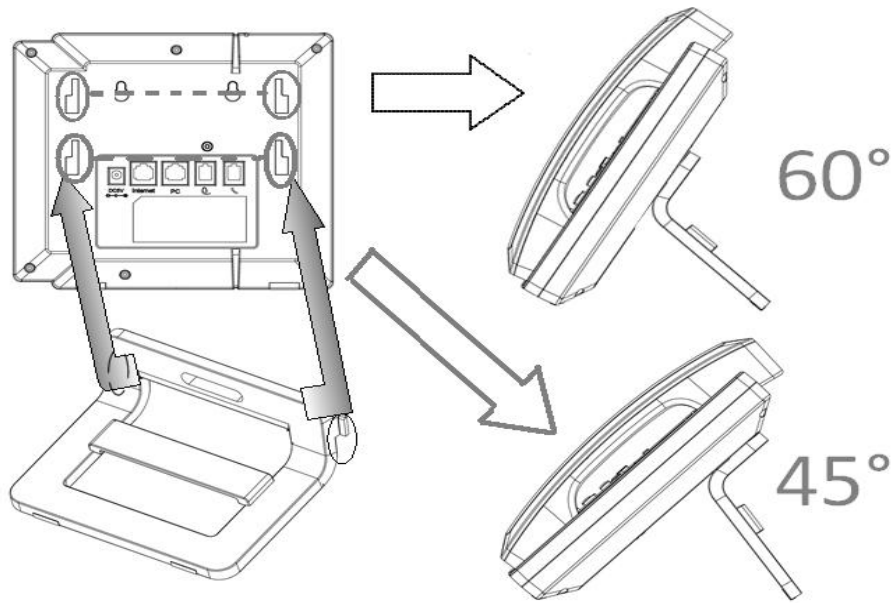

2. Connect the Handset and optional Headset

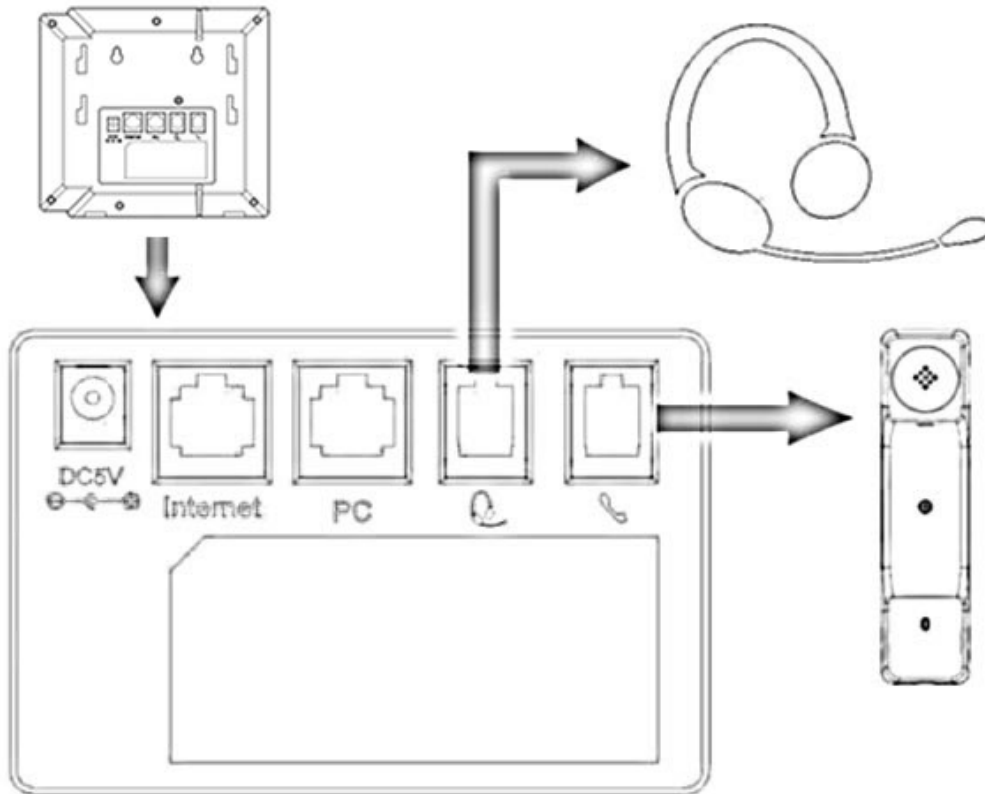

3. Connect the Network and Power

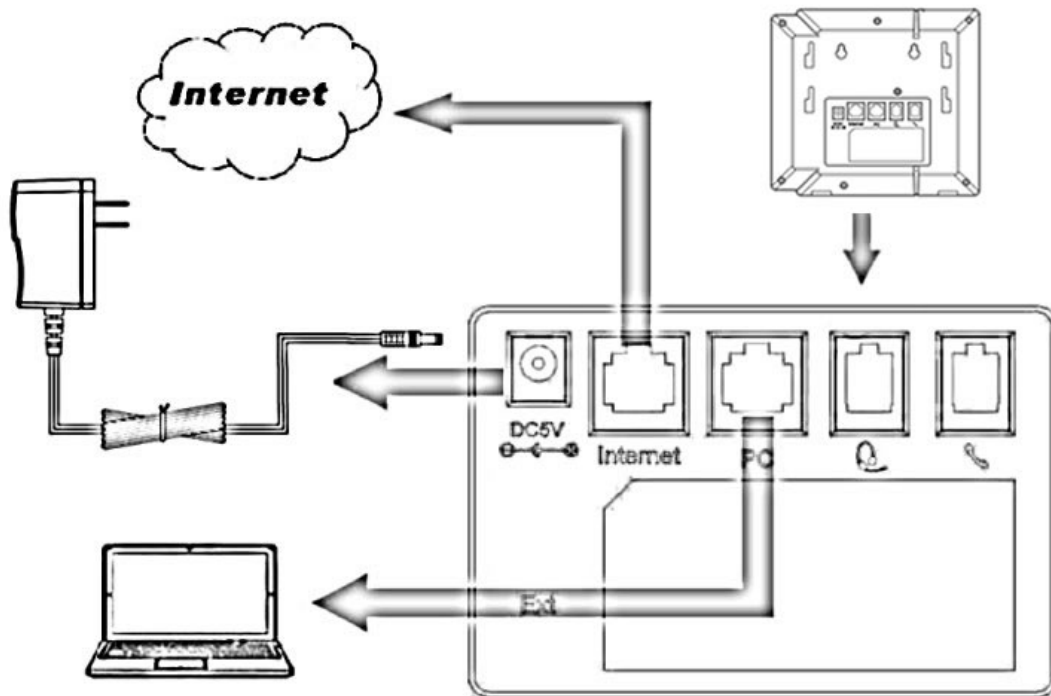

Initialization

After your phone has been powered up, the system boots up and performs the following steps:

Automatic Phone Initialization

The phone finishes the initialization process by loading the saved configuration. The phone LCD screen will display "Booting"

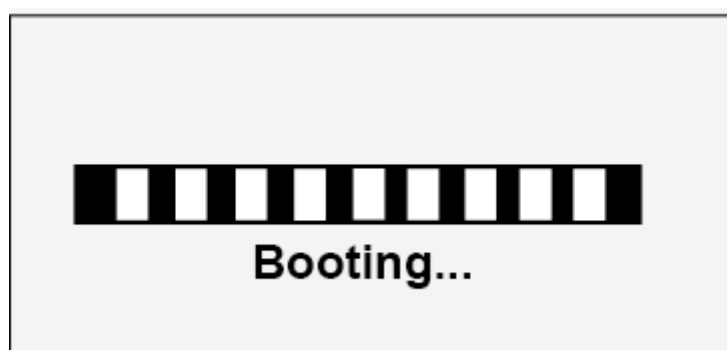

And then show “Initializing “during the initialization.



By default the phone attempts to contact a DHCP server in your network in order to obtain its valid network settings, e.g. IP address, subnet mask, default gateway, DNS server.

Status

You can view the system status of your phone via phone user interface or web user interface. The information of phone status includes: Information (e.g., Model, IP, MAC, Firmware, Hardware), Network(e.g., WAN Type, IP, Mask, LAN Type, Gateway, DNS...)Account (e.g., register status of accounts)

To view the phone status via phone interface:

1. Press Menu →Status →Information / Network

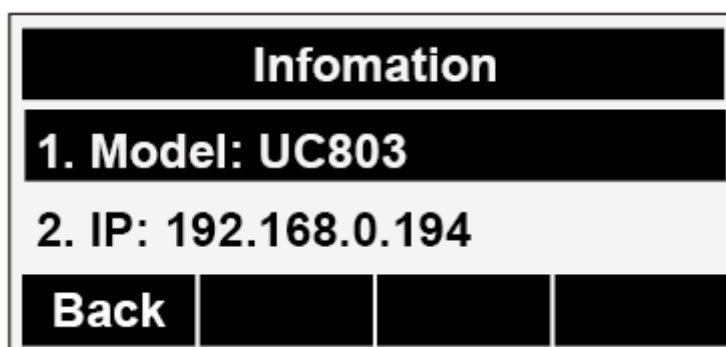

2. Press Menu →Status →Network

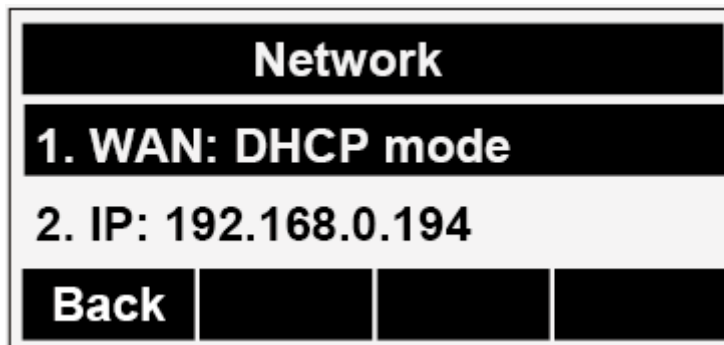

3. Press Menu → Status → Accounts

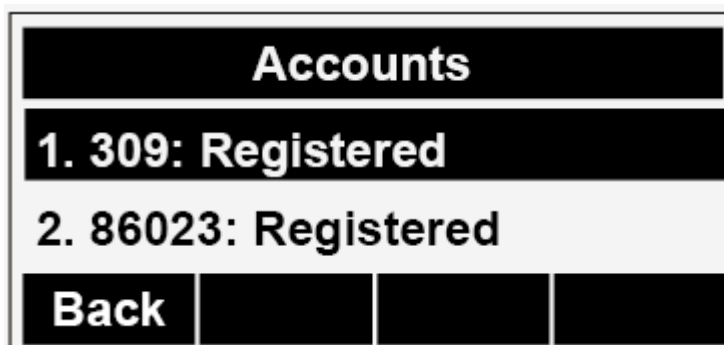

To view the phone status via Web interface:

1. Login webpage (for How to login, please refer to [Web Login](#))
2. View the information of Version, Account and Network.

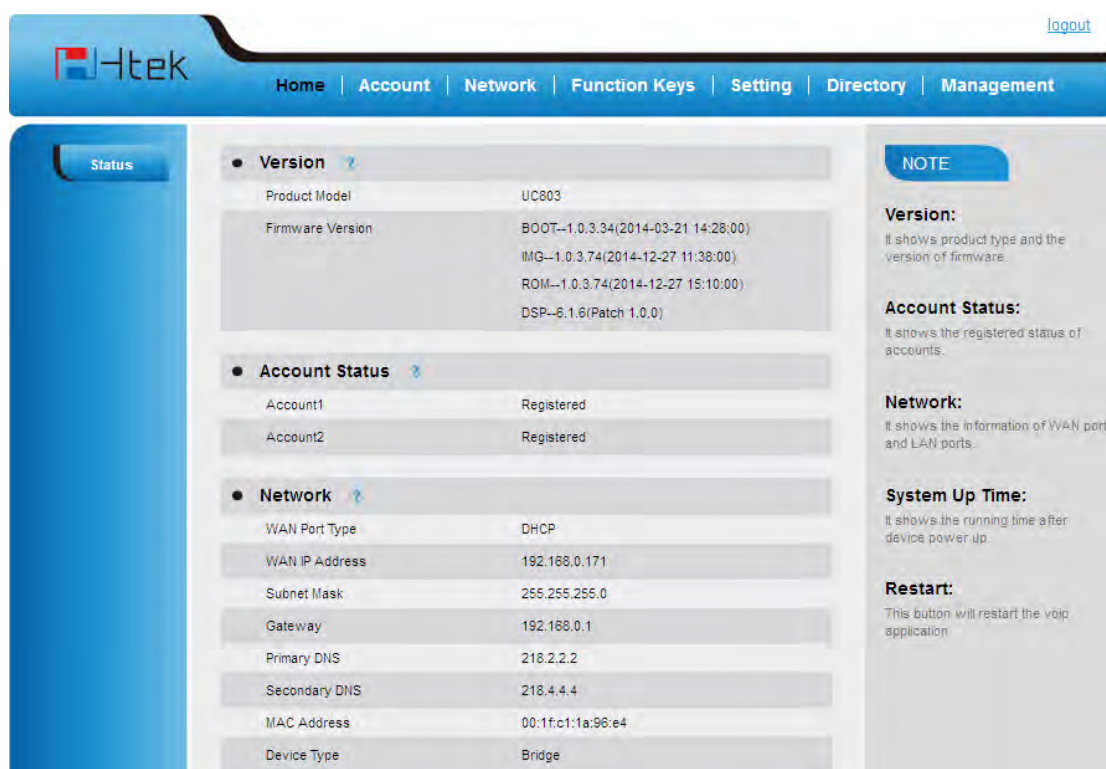

Status

- Version**

Product Model	UC803
Firmware Version	BOOT--1.0.3.34(2014-03-21 14:28:00) IMG--1.0.3.74(2014-12-27 11:38:00) ROM--1.0.3.74(2014-12-27 15:10:00) DSP--8.1.6(Patch 1.0.0)
- Account Status**

Account1	Registered
Account2	Registered
- Network**

WAN Port Type	DHCP
WAN IP Address	192.168.0.171
Subnet Mask	255.255.255.0
Gateway	192.168.0.1
Primary DNS	218.2.2.2
Secondary DNS	218.4.4.4
MAC Address	00:1f:c1:1a:96:e4
Device Type	Bridge

NOTE

Version:
It shows product type and the version of firmware.

Account Status:
It shows the registered status of accounts.

Network:
It shows the information of WAN port and LAN ports.

System Up Time:
It shows the running time after device power up.

Restart:
This button will restart the voip application.

Registration

To register via phone interface:

1. Press Menu→ Setting→Advanced settings (default password: admin)→Accounts
2. Select the desired account
3. Select Enable for Account active
4. Filled the SIP Server
5. Filled the Failover SIP server if need (Optional)
6. Filled the Outbound Proxy (Optional)
7. Filled the SIP User ID, Authenticate ID
8. Filled the password, Name (shown on LCD) and Ringtone.
9. Press Save to save the configuration.

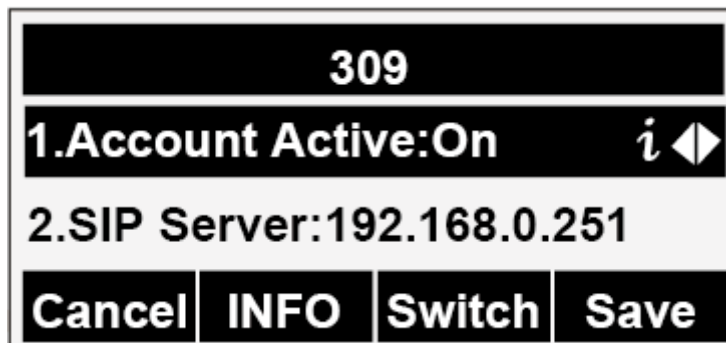

To register via web interface:

1. Login webpage and Click Account→Basic
2. Select the desired Account
3. Select Yes for Account Active
4. Filled the Primary SIP SERVER and other account information
5. Click  to save the configuration.

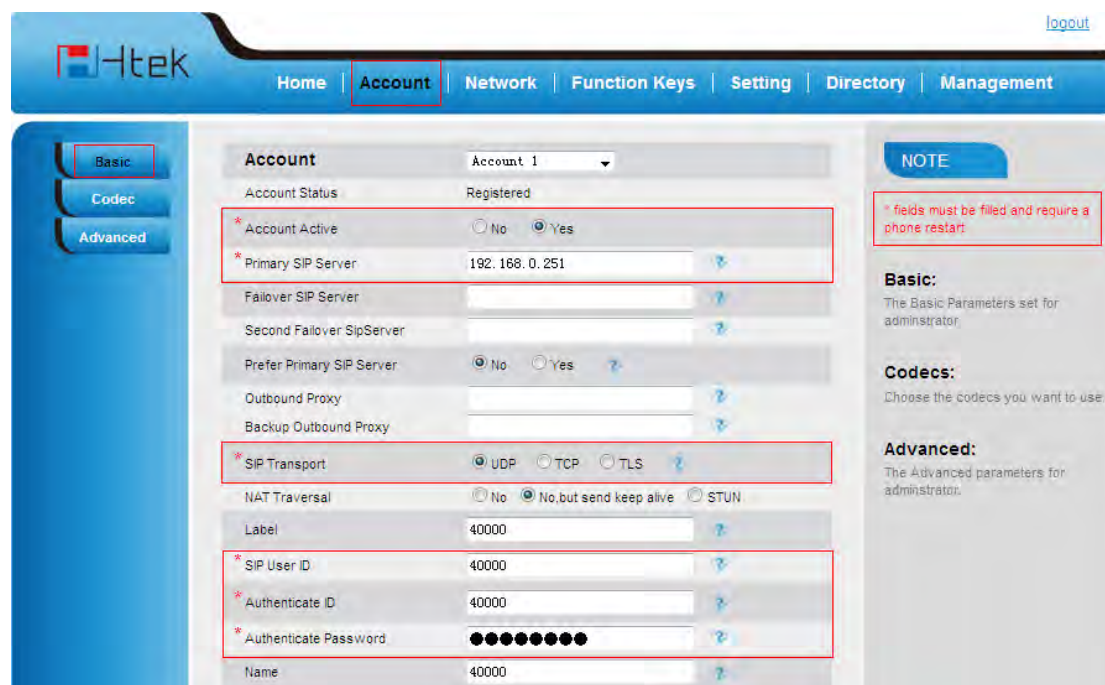



Note:

1. All fields with * must be filled. If changed, it requires a phone restart.

2. Account Status says the account registered successfully or not.
3. When change the account information via phone, it will shown Restart note when back to idle page.

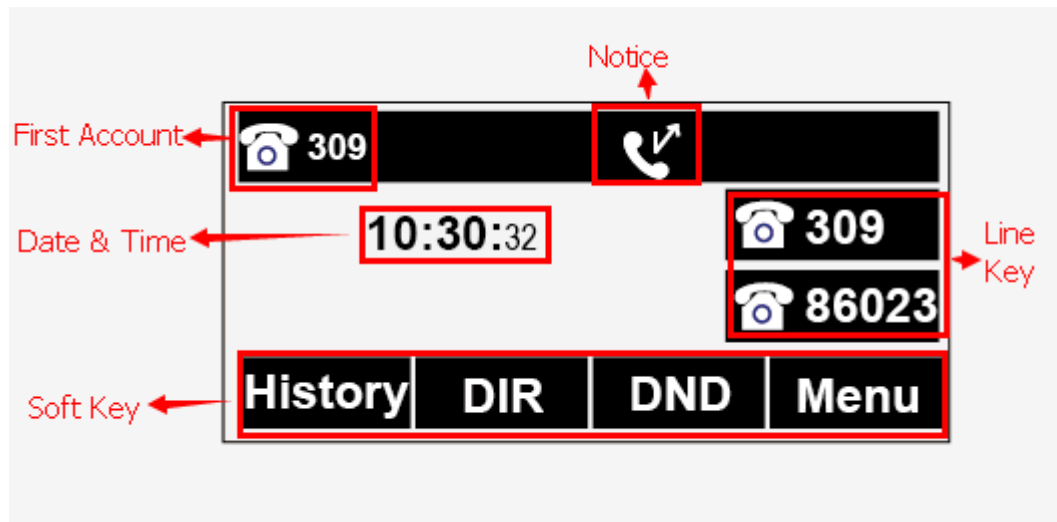
Idle Screen







Name	Description
1. Date&Time	It shows the phone's time & date. For Date&time setting, see Time&Date
2. Notice	It shows the phone features status, More see Icon Preview
3. Line Keys	This area shows the four line key labels. Line keys are also can be used as other function keys. For more information you can refer to Memory Keys
4. Soft Key	This area shows the soft key labels. The default soft key labels are "History", "Directory", "DND" and "Menu". More to see Programmable Key
5. First Account	This shows the first account. User can use to   change the default use account.

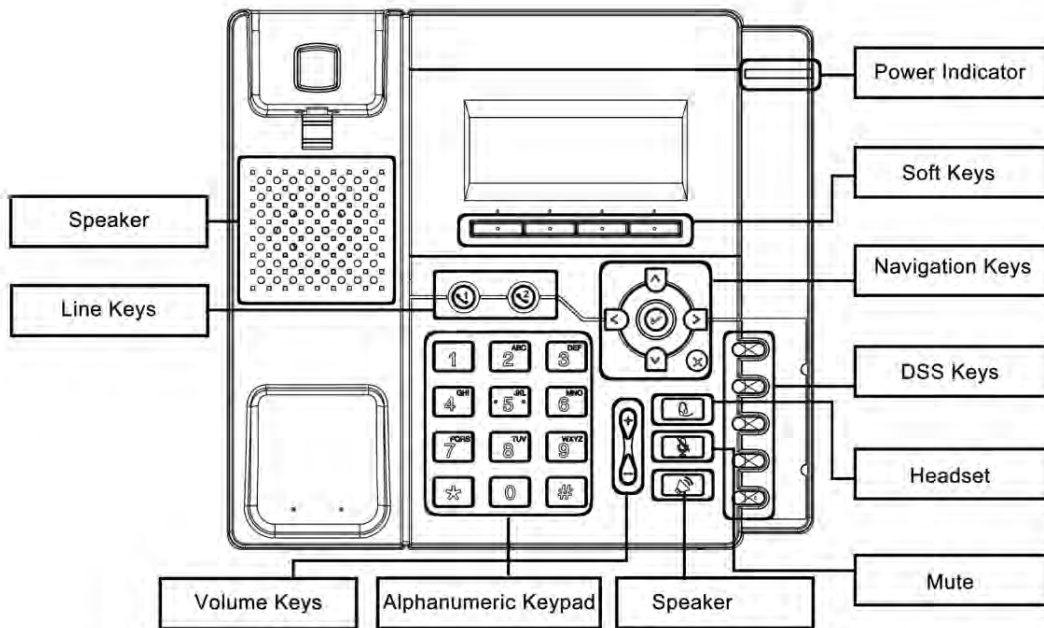



Getting Familiar with Your Phone

Hardware Components Preview









Item	Description
LCD screen	To Presentation all information about the date& time, accounts, soft keys, messages, calls and other some information.
Power Indicator LED	To indicate the power status
Line keys	The phone supported up to 4 accounts 1. Steady green: idle interface, during a call.. 2. Blink red: a call incoming
Soft keys	Labels automatically to identify their context-sensitive features.
Navigation keys	<p>1. OK.</p> <p>Up arrow key: To move up of the selection shows on the screen.</p> <p>Right arrow key: To move right of the selection</p>

	<p>shows on the screen.</p> <p> Left arrow key: To move left of the selection shows on the screen.</p> <p> Down arrow key: To move down of the selection shows on the screen.</p> <p> 1. To return to idle screen. 2. To cancel the information or call on the screen.</p>
<p>Mute key</p>	<p> 1. To mute the voice during the call (green light). 2. To un-mute the call.</p>
<p>Memory Keys</p>	<p>To be configured as different function as:</p> <ol style="list-style-type: none"> 1. Line 2. Speed Dial 3. BLF 4. BLF List 5. Voice mail 6. Direct Pickup 7. Group Pickup 8. Call Park 9. Intercom 10. DTMF 11. Prefix 12. Hold 13. Conference 14. DND 15. Redial 16. Transfer 17. SMS 18. Hot -desking 19. Call Return 20. Paging 21. Record 22. Shared Line <p>The LED lights status when set as Shared line:</p> <p>Stay green: Idle</p> <p>Stay red: Busy</p> <p>Blinked green: Ring Back</p> <p>Blinked red: A call incoming</p>

	Steady orange: During a call Blinked orange: Public Hold Blinked green: Private Hold Light Drown: Unregistered
Speaker	 Press this button to place a call in hands-free mode.
Volume	 To decrease the volume.  To increase the volume.
Alphanumeric keypad	To enter the phone numbers, letters and so on.
Message	 To indicator the New message, and press to read.
Headset	 To indicate that the phone is or not in Headset mode.

Icon Preview

Icon	Description
	Network
	Registered succeed
	Unregistered
	Speakerphone mode
	Handset mode
	Headset mode
	Mute

	Forward
	Do Not Disturb
	Received calls
	Dialed Calls
	Missed calls
	Forward calls

LED Instruction

This part mainly instructs the LED status. The Power LED Status describe on the premise that the LED setting all set as Yes. For LED status setting, please refer to: [LED Status Setting](#)

Power Indicator LED

LED Status	Description
Blinked green	Ringling or have missed call
Steady Green	Idle status(Power on)
Off	Powered off.

Line LED:(Line or Memory Key set as Line)

LED Status	Description
Steady Green	Hold
Steady Green	Off hook or during a conversation.
Blinked red	Ringling.
Off	Idle status

BLF or BLF List Key LED :(Line/Memory Key set as BLF)

LED Status	Description
Steady Green	Idle status for the monitored line
Steady Red	The monitored line is calling or during a call

Blinked red	The monitored line is ringing.
Off	All other unknown status

Shared Line Key LED :(Line/Memory Key set as Shared Line)

LED Status	Description
Stay green	Idle status
Stay red	The line is busy
Blinked green	Ring Back, Private hold
Blinked red	The line is ringing
Steady orange	During a Call
Blinked orange	Public Hold
Off	Unregistered

Other Key Led

Key	Description
Headset Key	When use in headset mode, the led is steady green or the LED is off.
Message Key	Blinked green when there is new messages or the LED is off.
Mute Key	Red when the mute the call, or the LED is off.

User Interface

There are two ways to customize specific configurations on your IP phone:

- The user interface on the IP phone
- The user interface in a web browser on your PC

The hardware components keypad and LCD screen constitute the phone user interface, which allows the user to execute all call operation tasks and basic configuration changes directly on the phone. In addition, you can use the web user interface to access all configuration settings. In many instances, it is possible to use both the phone user interface and the web user interface to operate the phone and change settings. However, in some instances, it is only possible to use the phone or the web user interface.

Phone Interface Overview

Option	
Status	Model
	IP
	MAC
	Firmware
	Hardware
	Network
	Account
	Device Cert
Features	Language
	Call Forward
	Function Key(Line and Memory key setting) More Key see Memory Key Overview
	Key as Send
	Hot Line
	Anonymous Call
	DND
	History Setting
Basic Settings	Language
	Time & Date
	Time & Date Format
	DHCP Time
	Ring tone
	Screensaver...
Advanced Settings	Account
	Network
	Factory Reset
	Auto provision
Directory	Add, view and delete

History	View and delete
Message	Voice Mail set and View. Text Message view and set.
Others	Factory Function
	System Restart
	Device Reboot
	Pcap Feature

Memory Key Function Overview

<u>Line</u>
<u>Speed Dial</u>
<u>BLF</u>
<u>BLF List</u>
<u>Voice Mail</u>
<u>Direct Pick Up</u>
<u>Group Pick Up</u>
<u>Call Park</u>
<u>Intercom</u>
<u>DTMF</u>
<u>Prefix</u>
<u>Local Group</u>
<u>XML group</u>

LDAP
XML Browser
Broadsoft group
Conference
Forward
Transfer
Hold
Group Listening
DND
Redial
Call Return
SMS
Record
URL Record
Paging
Shared Line
Public Hold
Private Hold

Basic Features Configuration

This part will mainly introduce the basic configuration as the Time, Language, and Volume...



Web Login

1. Get the IP address: Press Menu → Status → Information

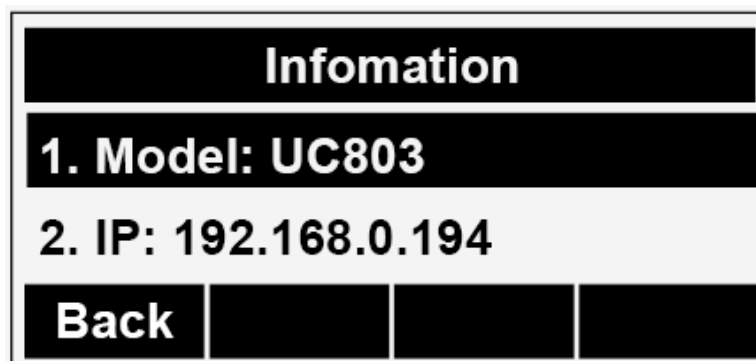

2. Input the IP Address in the web browser.
3. Input the user name (default is admin), password (default is admin).
4. Login successfully.

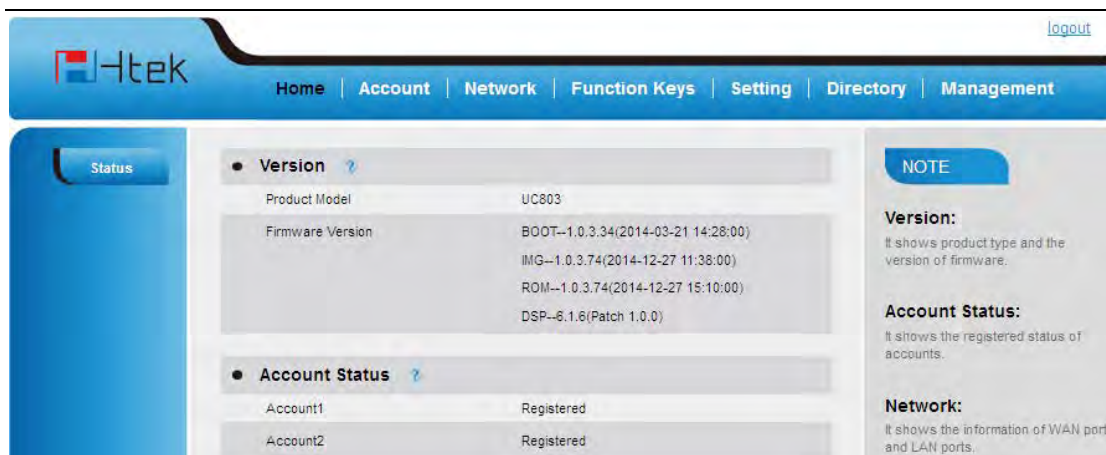

Note:

The PC and phone should be in the same segment.

When register the accounts in web and the server port is not “5060”, then “SIP Server” should be set as “SIP Server’s IP address: server port.”, for example, “192.168.0.122: 5090”.

Administrator Password

The password is mainly used for login the web interface or set the advanced settings through phone interface. And the default password of the administrator is: **admin**

To change to password via Phone Interface

1. Press Menu → setting → Advanced settings → password (default admin) → Phone Setting → Set Password
2. Enter the current PWD (password), new password and confirm the new password.
3. Press save soft key or  to save the new password.

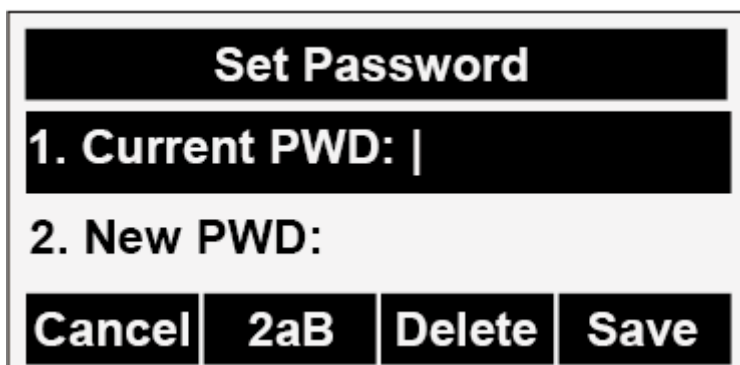

To change to password via Web Interface

1. Management → Password
2. Fill the value
3. Click  to save the configuration.

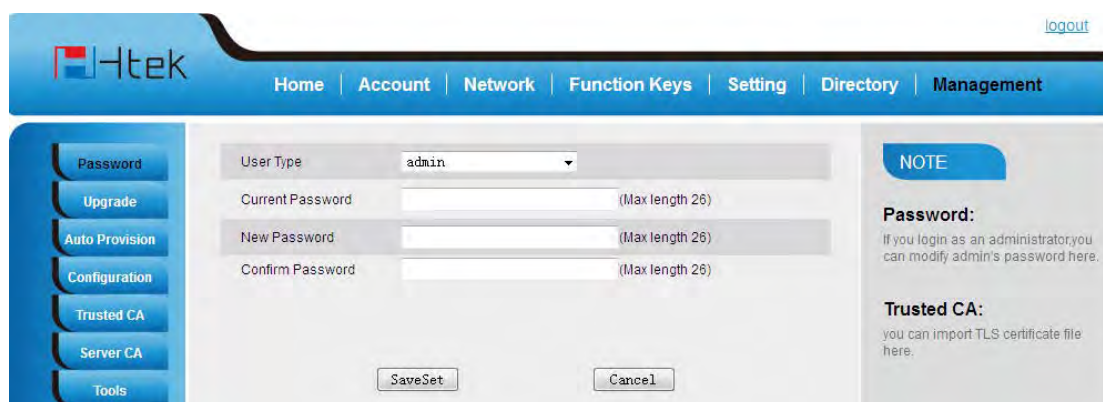

NOTE

Password:
If you login as an administrator, you can modify admin's password here.

Trusted CA:
you can import TLS certificate file here.

Note:

When you use the web interface: user name: admin password: admin(default)

Basic Network Setting

Htek IP Phone support three mode of Network: DHCP, Static, and PPPoE. The default mode is DHCP, it will obtain IP address and other information automatically.

If your phone cannot contact a DHCP server for any reason, you need to configure a static IP address manually.

When switch DHCP, Static IP and PPPoE to each other, or change the Static IP on webpage, it will show the warning of restart as following.

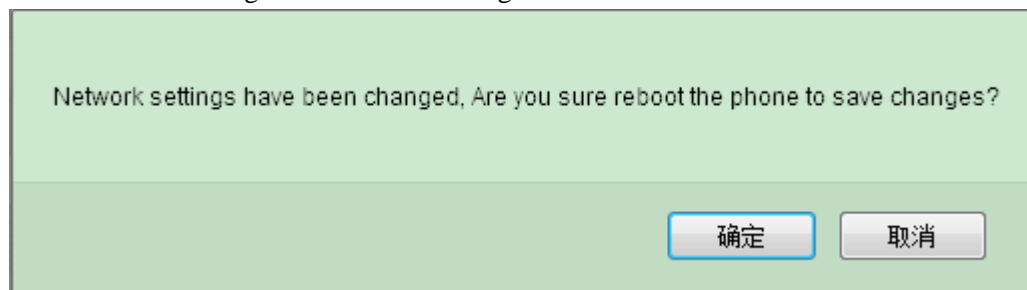

Network settings have been changed, Are you sure reboot the phone to save changes?

确定 取消

WAN Port

To configure a static IP address via phone interface:

1. Press Menu→Setting→Advanced Settings (password: admin) →Network→WANPort →Static mode.
2. Enter the parameters: IP, Netmask, Gateway, Pri. DNS (primary dns), sec. DNS(second DNS) in the corresponding fields.

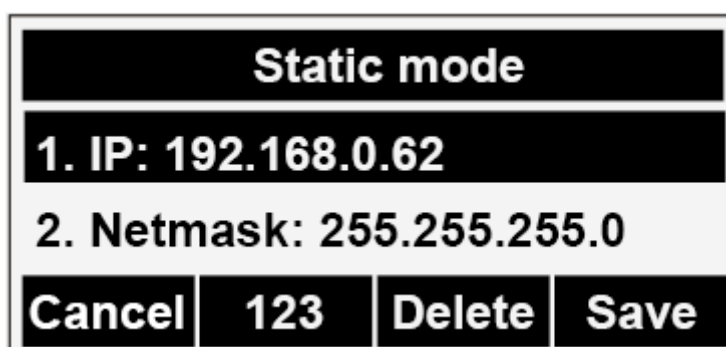

3. Click Save and restart the phone.

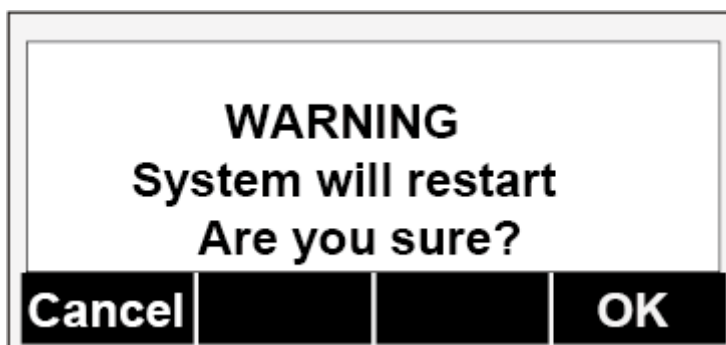

Press the Save soft key to accept the change or the Back soft key to cancel. If you are using an xDSL modem, you can connect your phone to the Internet via PPPoE mode. You can set a WAN port to be a PPPoE port. The PPPoE port will perform a PPP negotiation to obtain the IP address. Contact your system administrator for the PPPoE user name and password.

To configure PPPoE via phone interface:

1. Press Menu→Setting→Advanced Settings (password: admin) →Network→WANPort →PPPoE mode.

2. Enter the User ID and password
3. Click Save and restart the phone.

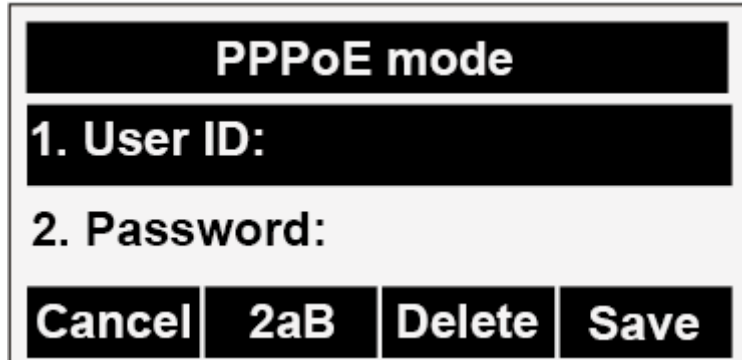

PPPoE mode

1. User ID:

2. Password:

Cancel **2aB** **Delete** **Save**

To configure DHCP via phone interface:

1. Press Menu→Setting→Advanced Settings (password: admin) →Network→WANPort →DHCP mode.
2. Click Save and restart the phone.

To configure Network via web interface:

1. Click Network→Basic
2. Select the desired Type: DHCP, Static or PPPoE
3. Filled the necessary information.
4. Click the SaveSet and restart the phone.

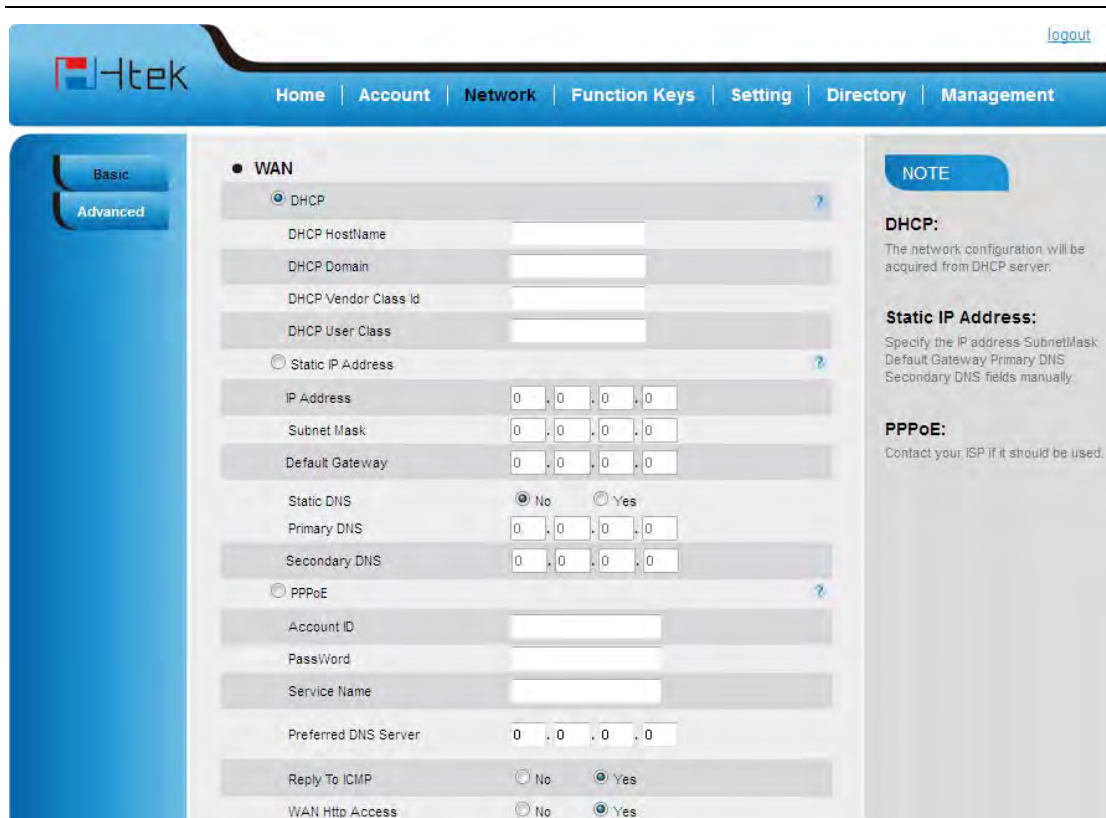

Note:
Wrong network parameters may result in inaccessibility of your phone and may also have an impact on your network performance. For more information about these parameters, contact your system administrator.

PC Port

Two modes for PC port: bridge and router.

To configure PC Bridge via Phone interface:

1. Press Menu → Setting → Advanced Settings (password: admin) → Network → PC Port → Bridge mode.
2. Click Save and restart the phone.

To configure PC router via Phone interface:

1. Press Menu → Setting → Advanced Settings (password: admin) → Network → PC Port → Router

mode.

2. Enter the IP, Netmask and DHCP server
3. Click Save and restart the phone.

To configure Bridge via web interface:

1. Click Network→Basic
2. Select As Bridge
3. Click and restart the phone

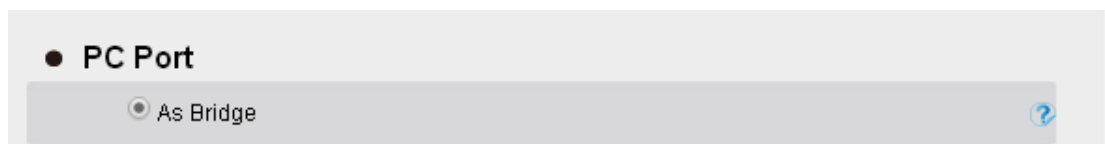

To configure Router via web interface:

1. Click Network→Basic
2. Select As Router
3. Fill the IP address and other necessary information.
4. Click and restart the phone

● **PC Port**

As Bridge ?

As Router ?

IP Address

Subnet Mask

IP Lease Time

DHCP Server

Language

The default Phone interface language is English.

To change the language via Phone interface

1. Press Menu → Setting → Basic Settings → Language.
2. Press  or Save soft key to save the configuration.



To change the language via Web Interface

1. Setting → Preference → Web Language
2. Select the necessary one.
3. Press  to save the configuration.





Note:

All languages may not be available for selection. The available languages depend on the language packs currently loaded to the IP phone.

Time and Date

The time and date show on the idle page, and it can be set and change by SNTP server automatically or manual setting.

To configure the time and Date by SNTP setting



1. To press Menu → Setting → Basic setting → Time & Date → SNTP Settings
2. Press  or , or Info soft key to change the Time zone.
3. Fill the NTP server1, NTP Server2, and Daylight Saving.
4. Press  or Save soft key to save the configuration.







Note:

Press , all zone will show on the display, select the one you want and press save or confirm key to save the configuration.



To configure time and date manually

1. To press Menu → Setting → Basic setting → Time & Date → Manual Settings
2. Press  and  or change the right time, or you can input the right time.
3. Press  or Save soft key to save the configuration.

To configure the Time & Date Format

1. To press Menu → Setting → Basic setting → Time & Date Format
2. Press  and  or press Info to change between 12 Hour or 24 Hour.
3. Press  and  or press Info to change among Y-M-D(year-month-day), M-D-Y(month-day-year), D-M-Y(day-month-year).
4. Press  or Save soft key to save the configuration.

To configure the DHCP time

1. To press Menu → Setting → Basic setting → DHCP time
2. Press  and  or press Info to change between Disable and Enable.
3. Press  or Save soft key to save the configuration.

To configure the NTP Server by web interface

1. Login name: admin, password: admin (default)
2. Setting → Date & Time → NTP Server
3. Fill the value in the blank.

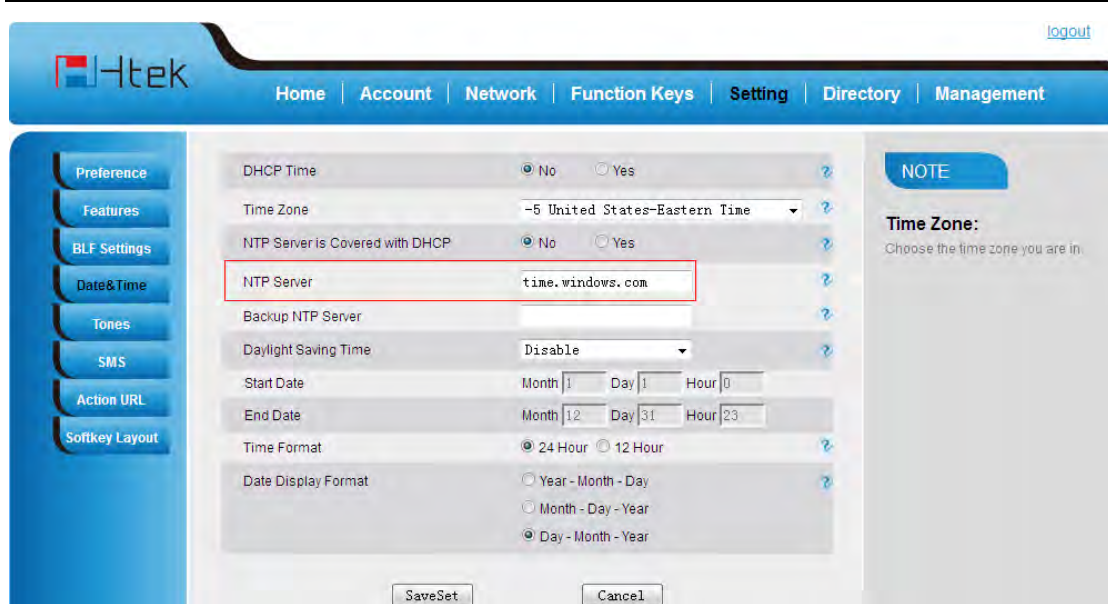

To change the Time Zone and Date Display Format via web interface

1. Setting → Date & Time
2. Select the necessary one.
3. Press  to save the configuration.

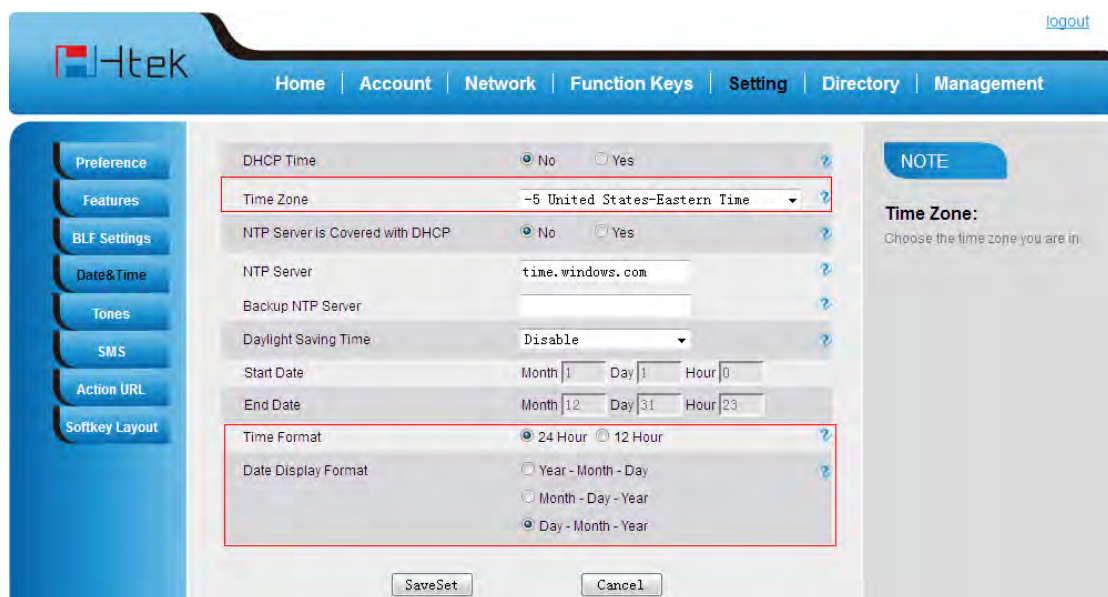



Note:

If the IP Phone cannot obtain the time and date from the Simple Network Time Protocol (SNTP) server, please contact your system administrator for more information.

Ring Tone

You can adjust the type and volume of the ring tone.

To adjust the Ring Tone Type via Phone interface

1. Press Menu → Setting → Basic Settings → Ring Tone.
2. Press  and  to select the aimed one.
3. Press  or Save soft key to save the configuration.

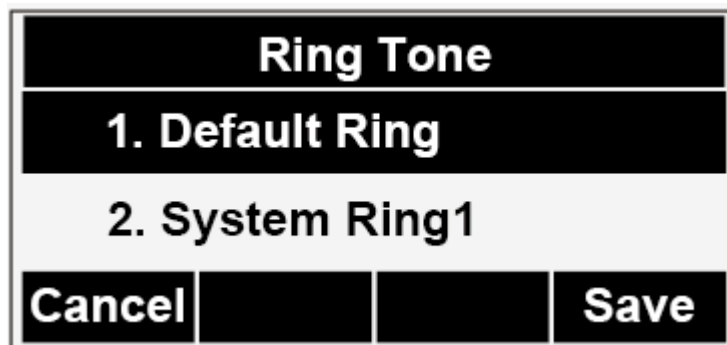

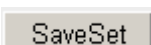

To adjust the Ring Tone Type via Web Interface

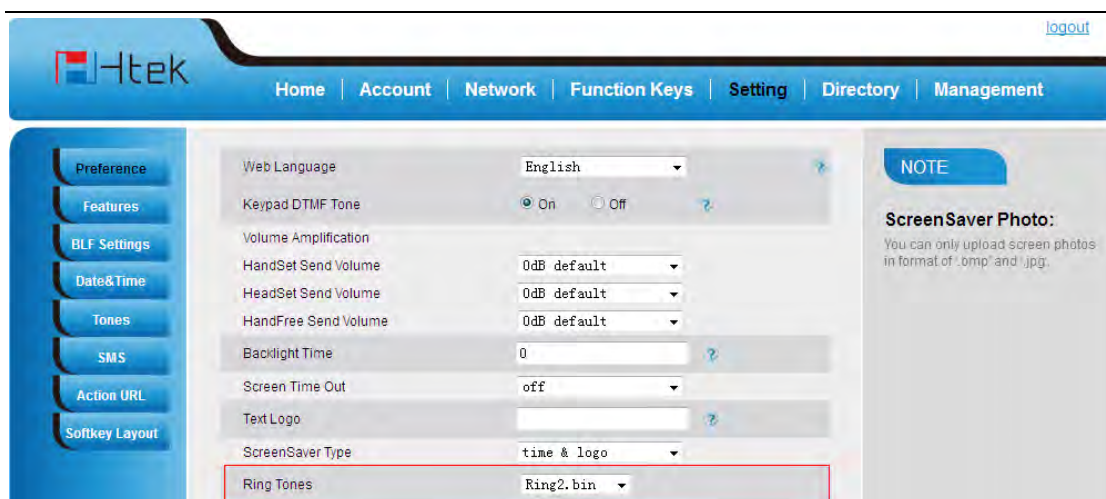

1. Setting → Preference → Ring Tone
2. Select the wanted one
3. Click  to save the configuration.





To configure Distinctive Ring Tone via Phone Interface

1. Press Directory
2. Select the target contact
3. Press Detail soft key to edit the contact.
4. Press  and  to select the wanted Ring Tone for the contact
5. Press Save soft key to save the contact.



Volume

You can adjust the volume for the phone by the volume keys:  and .

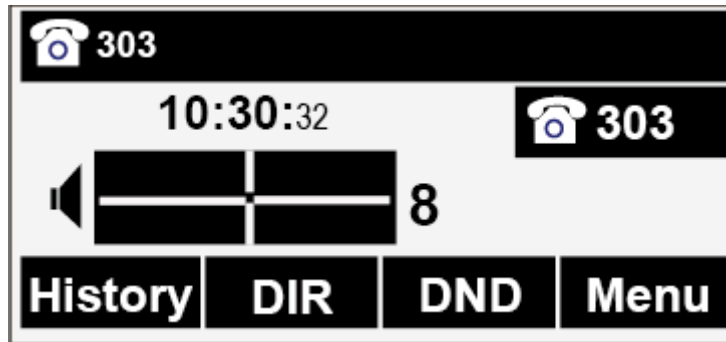

To adjust the Ring tone volume

1. Option 1: To press  and  on the idle page





2. Option 2: To press  and  during the call is ringing.

To adjust the handset volume

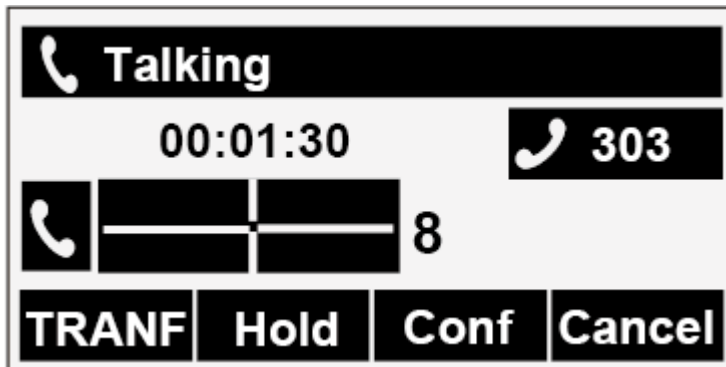
To press  and  during a call in handset mode.



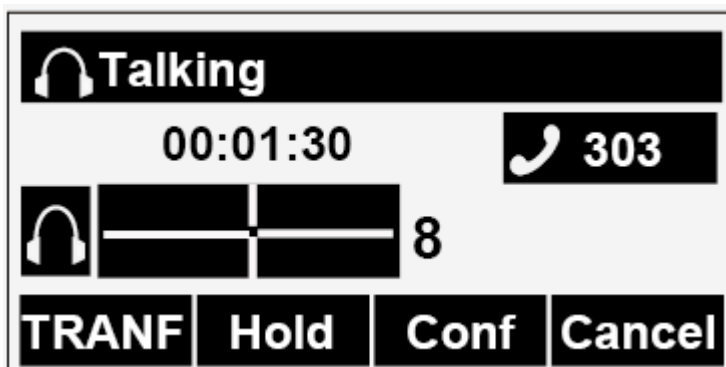

To adjust the headset volume

To press  and  during a call in headset mode.



To adjust the speaker Volume

To press  and  during a call in speaker mode.

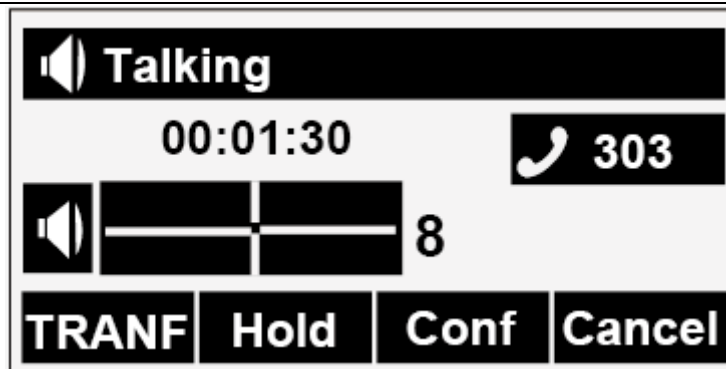

Screen Saver



There are two types of screen saver: Time & Logo, Logo only.

Time & Logo: when the screensaver works, it will show Time and logo in turns.

Logo only: when the screensaver works, it will show logo in turns.



Text logo: It works with the **Time & Logo**, when enter the value, it will display the time and the entered value in turns.

To enable screen saver via Phone interface:

1. To press Menu → Setting → Basic Setting → Screensaver...
2. Press  and  or press Switch soft key to Choose the Time-out as 1 min or 2/5/10/30 minute.
3. Enter the Screensaver Type to choose one of the type: Logo only, Time & Logo
4. Press  or Save soft key to save the selected configuration.



To disable screen saver via Phone interface

1. To press Menu → Setting → Basic Setting → Screensaver...
2. Press  and  or press Switch soft key to Choose the Time-out as off.
3. Press  or Save soft key to save the selected configuration.

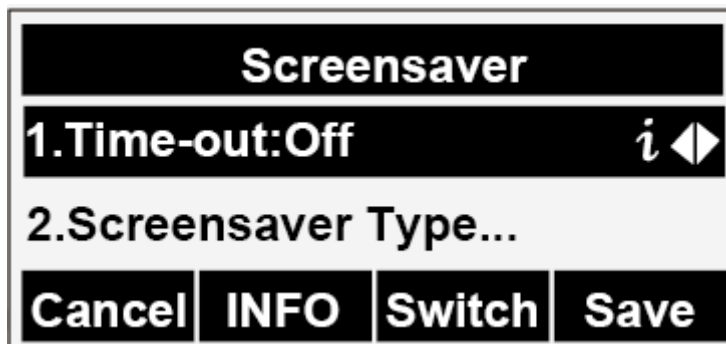

To enable screen saver via Web interface:

1. Setting → Preference
2. Choose the type wanted to use as screen saver
3. Click  to save the configuration.

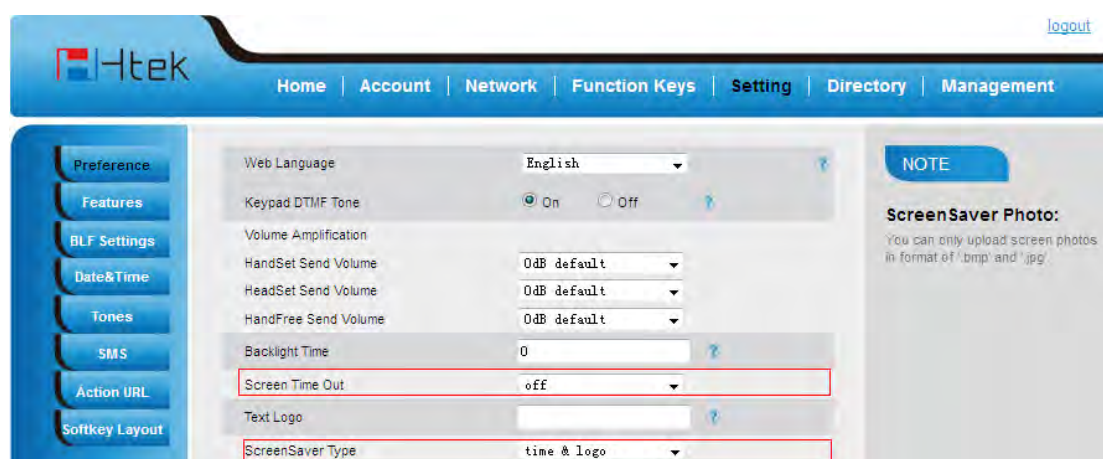

To custom text logo via web interface:

1. Click Setting → Preference.
2. choose the Time-out as 1 min or 2/5/10/30 minute.
3. Enter the desired value in the Text Logo field.

- Click SaveSet to save the configuration.

Screen Time Out	1 min	?
Text Logo	welcome	?

it will work when screensaver type is time & logo or logo only, and '\n' represents the newline

To wake up screen saver via Web interface:

- Click Setting → Preference
- Choose Dial First Digit: Screensaver Wakes up or Screensaver Wakes up and Dial

Dial First Digit	<input checked="" type="radio"/> Screensaver Wakes up <input type="radio"/> Screensaver Wakes up and Dial
------------------	--

Backlight

To set Backlight via web interface:

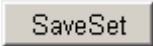
- Click setting → Preference
- Enter the time for Backlight time (In seconds).
- Click  to save the configuration.

The default is 0, which means Backlight is always on.

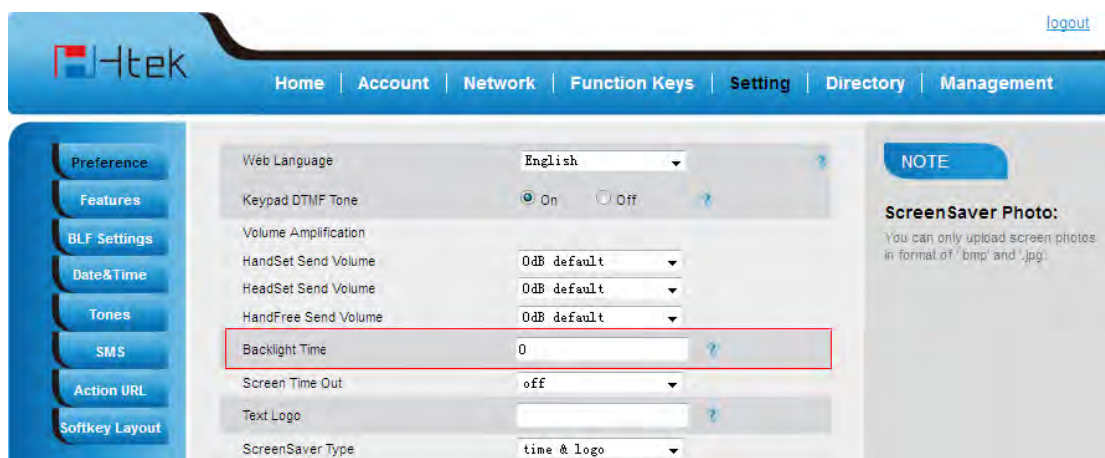

The screenshot shows the Htek web interface. The top navigation bar includes Home, Account, Network, Function Keys, Setting, Directory, and Management. The left sidebar has a Preference menu with options like Features, BLF Settings, Date&Time, Tones, SMS, Action URL, and Softkey Layout. The main content area shows various settings: Web Language (English), Keypad DTMF Tone (On), Volume Amplification, HandSet Send Volume, HeadSet Send Volume, HandFree Send Volume, Backlight Time (0), Screen Time Out (off), Text Logo, and ScreenSaver Type (time & logo). The Backlight Time field is highlighted with a red box. A NOTE section on the right states: 'ScreenSaver Photo: You can only upload screen photos in format of '.bmp' and '.jpg'.

Contact Management

This section provides the operating instructions for managing contacts. The topics include:

1. Contacts
2. Blacklist
3. Remote Phonebook
4. Call History
5. LDAP
6. BroadSoft Phonebook
7. CallLog

Local Directory

In the directory, you can add or delete your friends, business partner or anyone others' phone No. so you will not forget their number. Or put some anonymous phone No. in the blacklist to prevent from being disturbed. The local Directory can add up to 1000 contacts.

A. To add contacts list into local directory

To add contacts manually

1. Press Menu → DIR → More
2. Press Add soft key







Add Contacts			
1. Name:			
2. Number:			
Cancel	2aB	Delete	Save



3. Enter the necessary information as Name, Phone number...

4. Press save soft key or  to add the contacts successfully.

To add contacts from History

-
1. Press History soft key or press Menu → History → Local history
 2. Press  and  to select the targeted one. (Press  and  switched among the All calls, Dialed calls, Received calls, Missed Calls and Forward Calls).
 3. Press Option soft key → Add to Contacts
 4. Edit the necessary information as Name, Phone number...
 5. Press save soft key or  to add the contacts successfully.

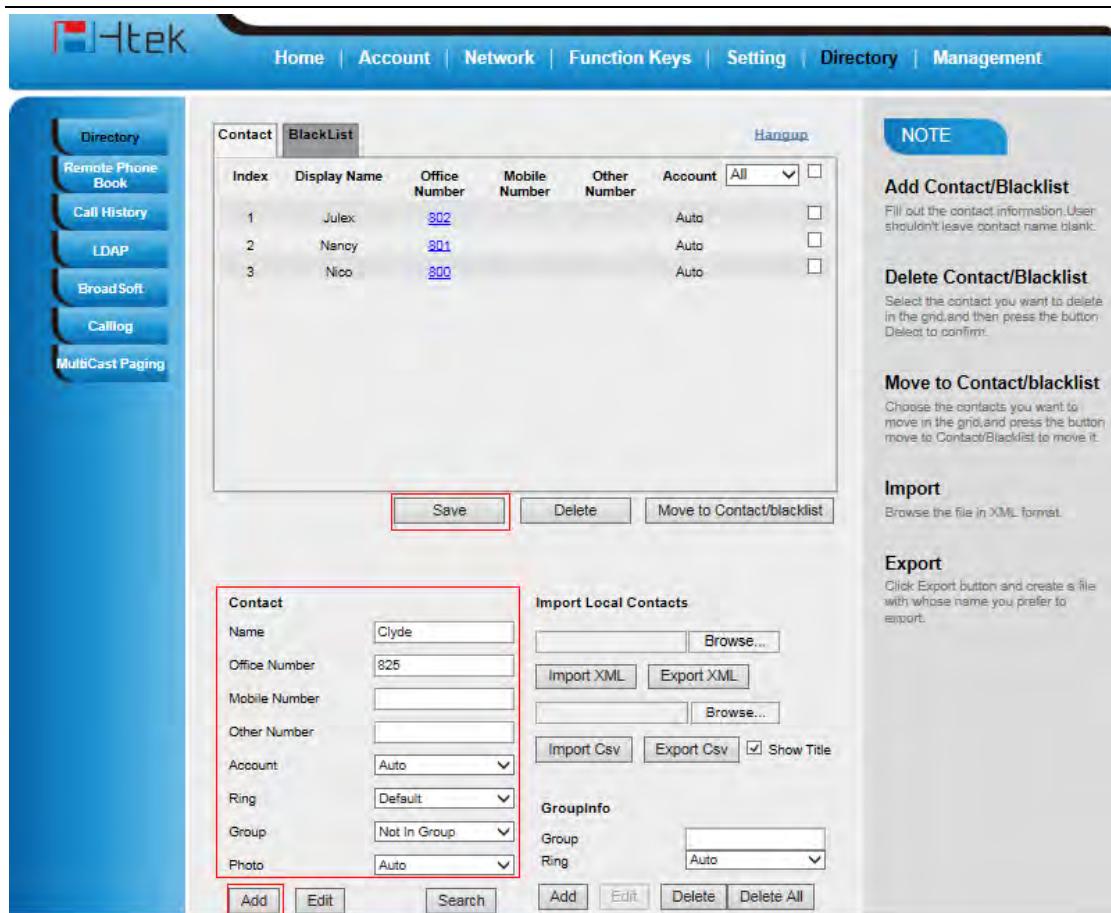

To add contacts via web interface

1. Click Directory→Directory
2. Enter the name, number and some other information.
3. Press  and then press  button.





B: To add contacts into blacklist

To add blacklist manually

1. Press Menu → DIR
2. Press  and  or press Switch soft key to Choose the Contacts.
3. Press More soft key.
4. Press More soft key.
5. Press Option soft key. Add to blacklist.
6. Press save soft key or  to add the contacts successfully.

To add blacklist from history

1. Press History soft key or press Menu → History → Local history

-
2. Press  and  to select the targeted one.
 3. Press Option soft key → Add to Blacklist
 4. Edit the necessary information as Name, Phone number...
 5. Press save soft key or  to add successfully.

To import or export the contact list

You can manage your phone's local directory via phone or web user interface. But you can only import or export the contact list via web interface.

To import an XML file of contact list via web interface:

1. Click on Directory
2. Click Browse to select a contact list file (file format must be .xml) from your local system.
3. Click Import XML to import the contact list.

To export an XML file of contact list via web interface:

1. Click on Directory
2. Click Export XML to export the contact list.

To import a CSV file of contact list via web interface:

1. Click on Directory
2. Click Browse to select a contact list file (file format must be .csv) from your local system.
3. Click Import Csv to import the contact list.

To export a CSV file of contact list via web user interface:

1. Click on Directory
2. Click Export Csv to export the contact list.

Note:

If the xml file and CSV file more than 1000 contacts, the phone will only upload 1000 contacts.

Remote Phonebook

To set Remote PhoneBook via web interface:

1. Login the webpage and click Directory→Remote Phone Book
2. Fill the path of the remote file in the Phone Book URL field.
For example,
<http://192.168.0.240/Phonebook/Phonebook.xml>
3. Fill the Name and then click to save the configuration.

Index	Phone Book URL	Name
1	http://192.168.0.240/Phonebook/Phonebook	Remote_1
2		
3		
4		
5		

To check the contacts via phone interface:

1. Press Directory→Left Button→Left Button, and then you can see the item you set, press enter you will find the detail.

For More detail, please refer to: [Remote Phonebook](#) on www.h-tek.com.



Note:

Every remote contact only support 1000 contacts.

Call History

This phone maintains call history lists of Dialed Calls, Received Calls, Missed Calls and Forwarded Calls. The call history list supports up to 100 entries in all on phone interface and more than 1500 items. You can check the call history, dial a call, add a contact or delete an entry from the call history list. You should enable the history record feature in advance.

To enable the history record feature via phone interface:

1. Press Menu→Feature→History Setting
2. Press  and  or Switch soft key to enable History record.
3. Press Save soft key to save the configuration.



To check the call history via phone interface:

1. Press the History soft key. The LCD screen displays All Calls list.
2. Press Right or Left Key to switch among All Calls, Missed Calls, Received Calls, Dialed Calls and Forwarded Calls.
3. Press to select the desired entry.
4. Press the Option soft key, and then select Detail from the prompt list.
5. The detailed information of the entry appears on the LCD screen.

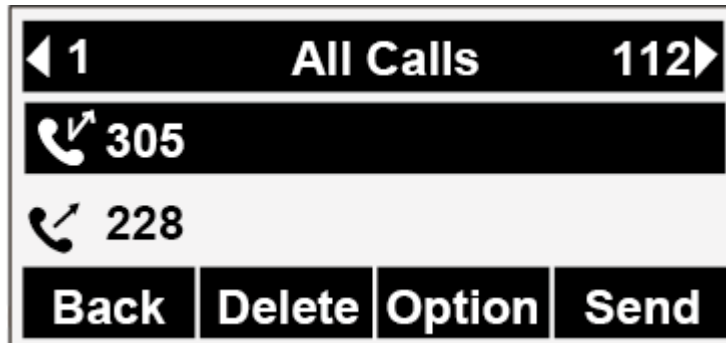

To delete an entry from the call history list via phone interface::

1. Press the History soft key.
2. Press Right or Left Key to switch among All Calls, Missed Calls, Received Calls, Dialed Calls and Forwarded Calls.
3. Press UP or DOWN key to select the desired entry.
4. Press the Delete soft key.

To delete all entries from the call history list via phone interface:

1. Press the History soft key.
2. Press Right or Left Key to switch among All Calls, Missed Calls, Received Calls, Dialed Calls and Forwarded Calls.
3. Press the Option soft key, and then select Delete All from the prompt list.
4. Press the OK soft key.
5. Press the OK soft key to confirm the deleting or the Cancel soft key to cancel.

To check the call history via web interface:

1. Click Directory → Call History
2. Click Dialed List, Missed List, Received List, Forwarded List then you can see the history list.

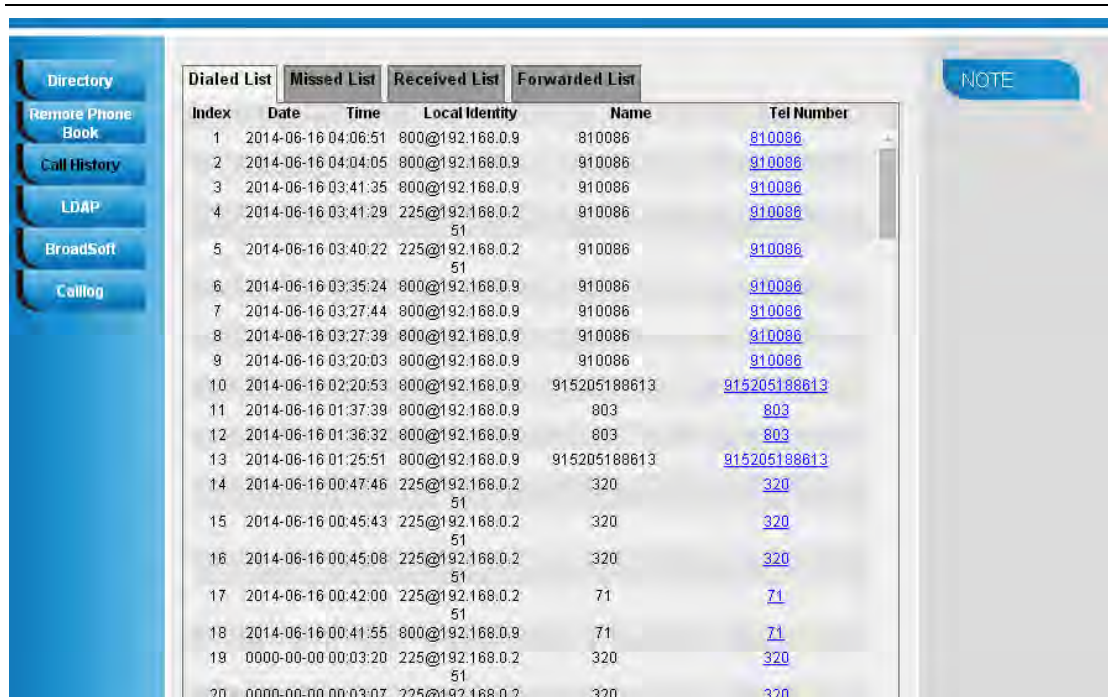

Index	Date	Time	Local Identity	Name	Tel Number
1	2014-06-16	04:06:51	800@192.168.0.9	910086	910086
2	2014-06-16	04:04:05	800@192.168.0.9	910086	910086
3	2014-06-16	03:41:35	800@192.168.0.9	910086	910086
4	2014-06-16	03:41:29	225@192.168.0.2	910086	910086
5	2014-06-16	03:40:22	225@192.168.0.2	910086	910086
6	2014-06-16	03:35:24	800@192.168.0.9	910086	910086
7	2014-06-16	03:27:44	800@192.168.0.9	910086	910086
8	2014-06-16	03:27:39	800@192.168.0.9	910086	910086
9	2014-06-16	03:20:03	800@192.168.0.9	910086	910086
10	2014-06-16	02:20:53	800@192.168.0.9	915205188613	915205188613
11	2014-06-16	01:37:39	800@192.168.0.9	803	803
12	2014-06-16	01:36:32	800@192.168.0.9	803	803
13	2014-06-16	01:25:51	800@192.168.0.9	915205188613	915205188613
14	2014-06-16	00:47:46	225@192.168.0.2	320	320
15	2014-06-16	00:45:43	225@192.168.0.2	320	320
16	2014-06-16	00:45:08	225@192.168.0.2	320	320
17	2014-06-16	00:42:00	225@192.168.0.2	71	71
18	2014-06-16	00:41:55	800@192.168.0.9	71	71
19	0000-00-00	00:03:20	225@192.168.0.2	320	320
20	0000-00-00	00:03:07	225@192.168.0.2	320	320

To Dial a call from Call History via web interface:



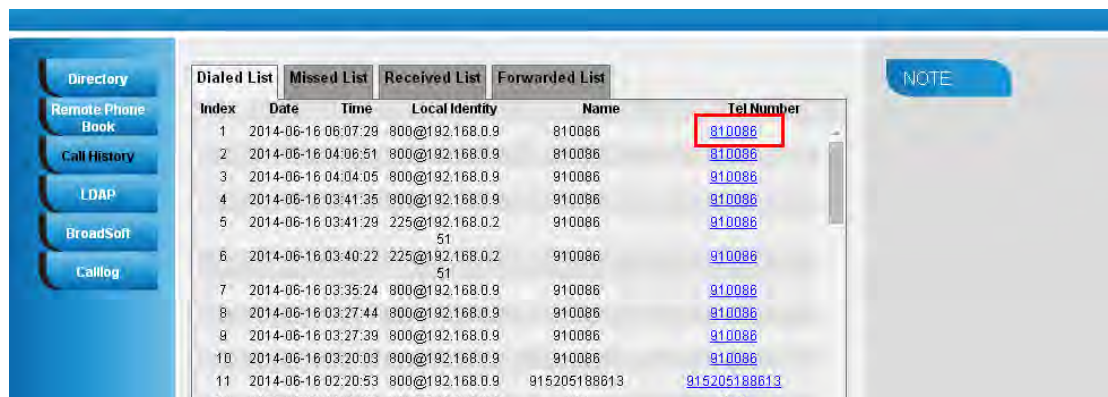

1. Click Directory → Call History
2. Select the desired history item, and click Tel Number.
3. Then the call is dialed on phone.



Index	Date	Time	Local Identity	Name	Tel Number
1	2014-06-16	06:07:29	800@192.168.0.9	910086	910086
2	2014-06-16	04:06:51	800@192.168.0.9	910086	910086
3	2014-06-16	04:04:05	800@192.168.0.9	910086	910086
4	2014-06-16	03:41:35	800@192.168.0.9	910086	910086
5	2014-06-16	03:41:29	225@192.168.0.2	910086	910086
6	2014-06-16	03:40:22	225@192.168.0.2	910086	910086
7	2014-06-16	03:35:24	800@192.168.0.9	910086	910086
8	2014-06-16	03:27:44	800@192.168.0.9	910086	910086
9	2014-06-16	03:27:39	800@192.168.0.9	910086	910086
10	2014-06-16	03:20:03	800@192.168.0.9	910086	910086
11	2014-06-16	02:20:53	800@192.168.0.9	915205188613	915205188613
12	2014-06-16	01:37:39	800@192.168.0.9	803	803
13	2014-06-16	01:36:32	800@192.168.0.9	803	803
14	2014-06-16	01:25:51	800@192.168.0.9	915205188613	915205188613
15	2014-06-16	00:47:46	225@192.168.0.2	320	320
16	2014-06-16	00:45:43	225@192.168.0.2	320	320
17	2014-06-16	00:45:08	225@192.168.0.2	320	320
18	2014-06-16	00:42:00	225@192.168.0.2	71	71
19	2014-06-16	00:41:55	800@192.168.0.9	71	71
20	0000-00-00	00:03:20	225@192.168.0.2	320	320
21	0000-00-00	00:03:07	225@192.168.0.2	320	320

To Dial a call from Call History via phone interface:

1. Press History soft key or press Menu → History → Local history

-
2. Press  and  to select the targeted one.
 3. Press the Send soft key, or , or , or the corresponding line key.

LDAP Phonebook

When use the LDAP feature, you can get the LDAP Phonebook directly.

To configure LDAP via web interface:

1. Login webpage and click Directory→LDAP
2. Filled the LDAP Name Filter:
 - a) This parameter specifies the name attributes for LDAP searching. The “%” symbol in the filter stands for the entering string used as the prefix of the filter condition.
 - b) For example (cn=%), when the name prefix of the cn of the contact record matches the search criteria, the record will be displayed on the IP PHONE LCD.
3. Filled LDAP Number Filter:

This This parameter specifies the number attributes for LDAP searching.
4. Filled Server Address: Fill the domain name or IP address of the LDAP Server.
For example: 192.168.0.124
5. Port(the port of the LDAP Serve) Base, User Name, Password
6. Max.Hits(1-32000): the maximum number of the search results to be returned by the LDAP server.
7. LDAP Display Name: the display name of the contact record displayed on the LCD screen.
8. Filled the relative value and then click save button the save the settings.

Following is the example screenshot for the configuration.

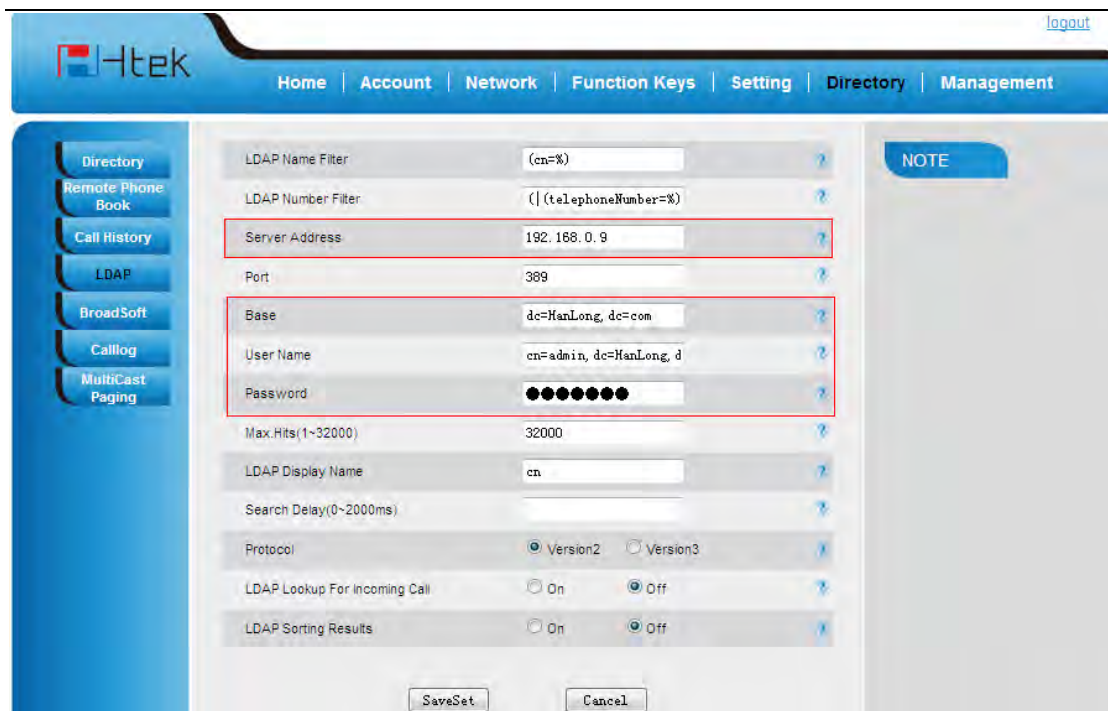

To Configure LDAP Key

To configure LDAP Key via web interface:

1. Click Function Key→Memory Key→ choose Memory Key 1(for example)
2. Select LDAP in the Type field.
3. Click  to save the configuration.

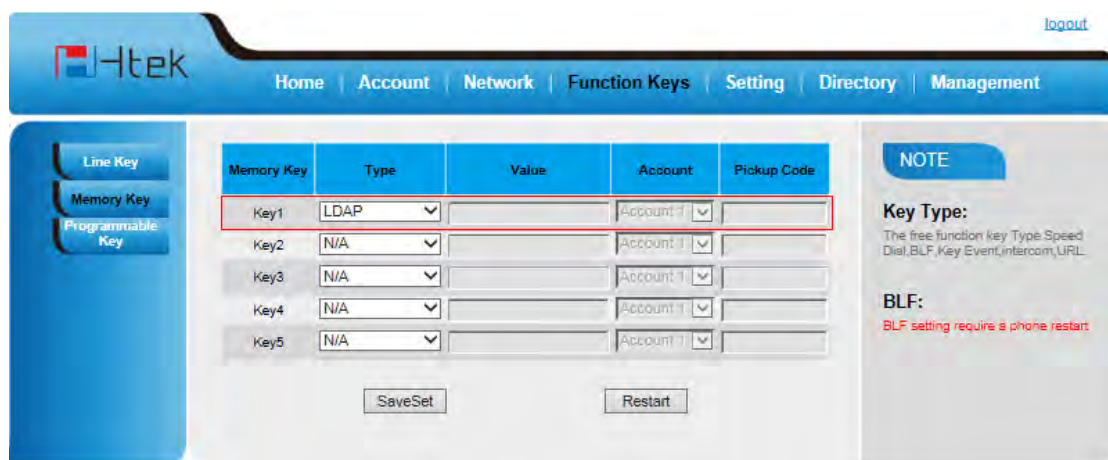

To Configure LDAP Key via phone interface:

1. Press Menu→Feature→Function Keys→Memory Keys as Function Keys→Memory Key 1
2. Select LDAP in the Type field
3. Press save or OK key to save the configuration.

When press the LDAP Key the LCD will display as following:

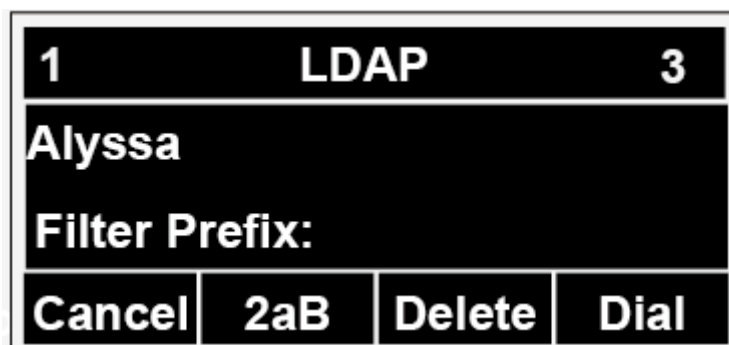

For More detail, please refer to [LDAP Notes](http://www.h-tek.com) on www.h-tek.com

Broadsoft Phonebook

You can access the BroadSoft directory through your phone. You can add local contacts from the BroadSoft directory. You can also dial a contact from the BroadSoft directory. You can configure your new phone to access up to 6 BroadSoft directories and every broadsoft directory support 100 contacts. Contact your system administrator for the access URL of the BroadSoft directory.

To Configure Broadsoft via web interface:

1. To click Directory→Broadsoft
2. Select the desired Broadsoft Item
3. Enter the Display name
4. Enter the Server, port, User and password
5. Click to save the configuration.

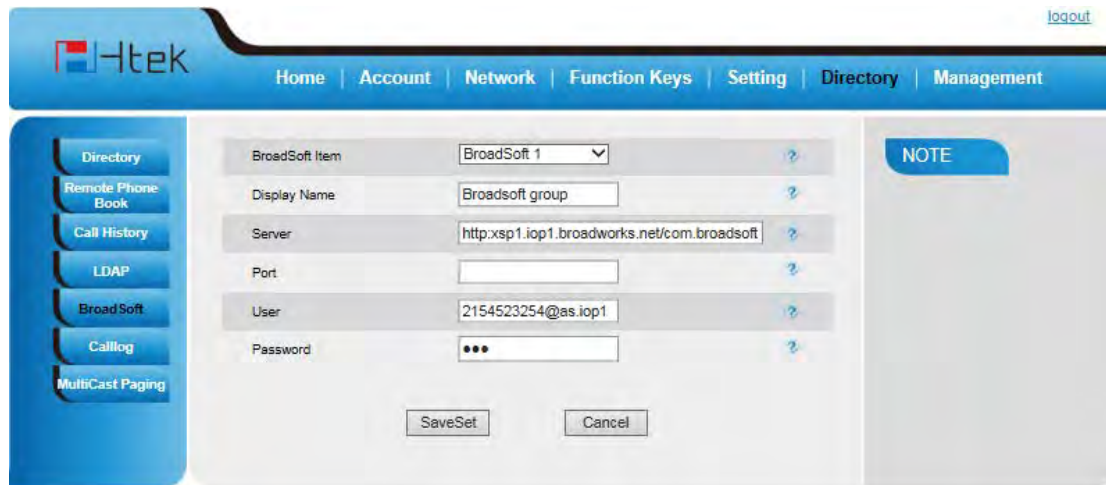

Call log

You can access the call log of the BroadSoft user through the IP phone. The call log contains call information such as remote party identification, time and date. You can check the call log and dial a call from the call log list. The BroadSoft call log allows users to view and dial the stored numbers in the following lists: missed, received, and placed. You can configure the IP phone to access up to 3 call log items and every call log item support 100 contacts. Contact your system administrator for the access URL of the BroadSoft call log.

To Configure Call log via web interface:

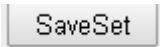
1. To click Directory→Call log
2. Select the desired Call log Item
3. Enter the Display name
4. Enter the Server, port, User and password
5. Click  to save the configuration.

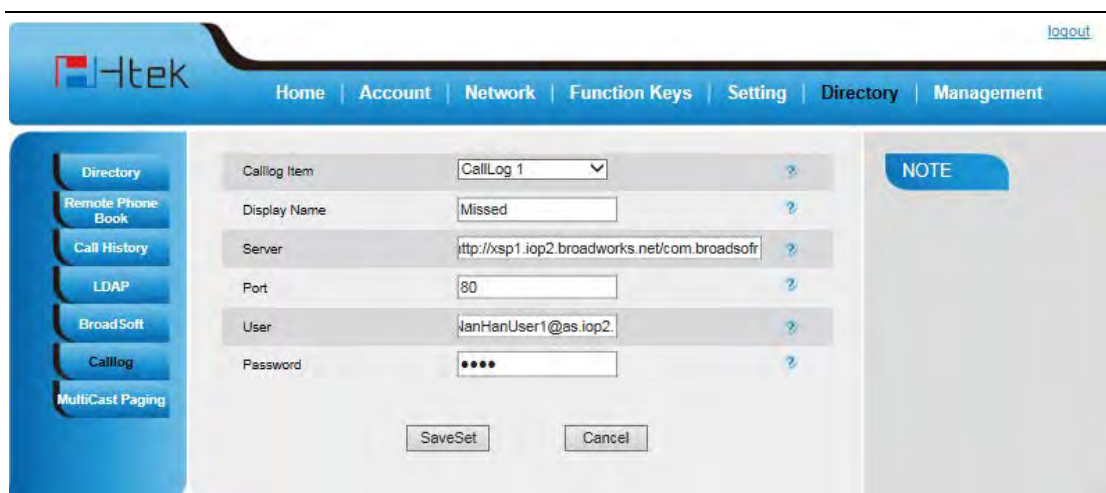

Other features settings

Dial Plan

Dial plan is a string of characters that governs the way this phone processes the inputs received from your phone keypad. This phone supports dial plan with following accept digits:

1,2,3,4,5,6,7,8,9,0,*,#

Grammer	Description
x	any digit from 0-9;
xx+	at least 2 digit number;
^	exclude;
,	hear dial tone;
[3-5]	any digit of 3, 4, or 5;
[147]	any digit 1, 4, or 7;
<2=011>	replace digit 2 with 011 when dialing.

To configure dial plan via web interface:

1. Click Account—Advanced—Dial Plan.

2. Filled the value in dial plan field.
3. Click SaveSet to save the configuration.

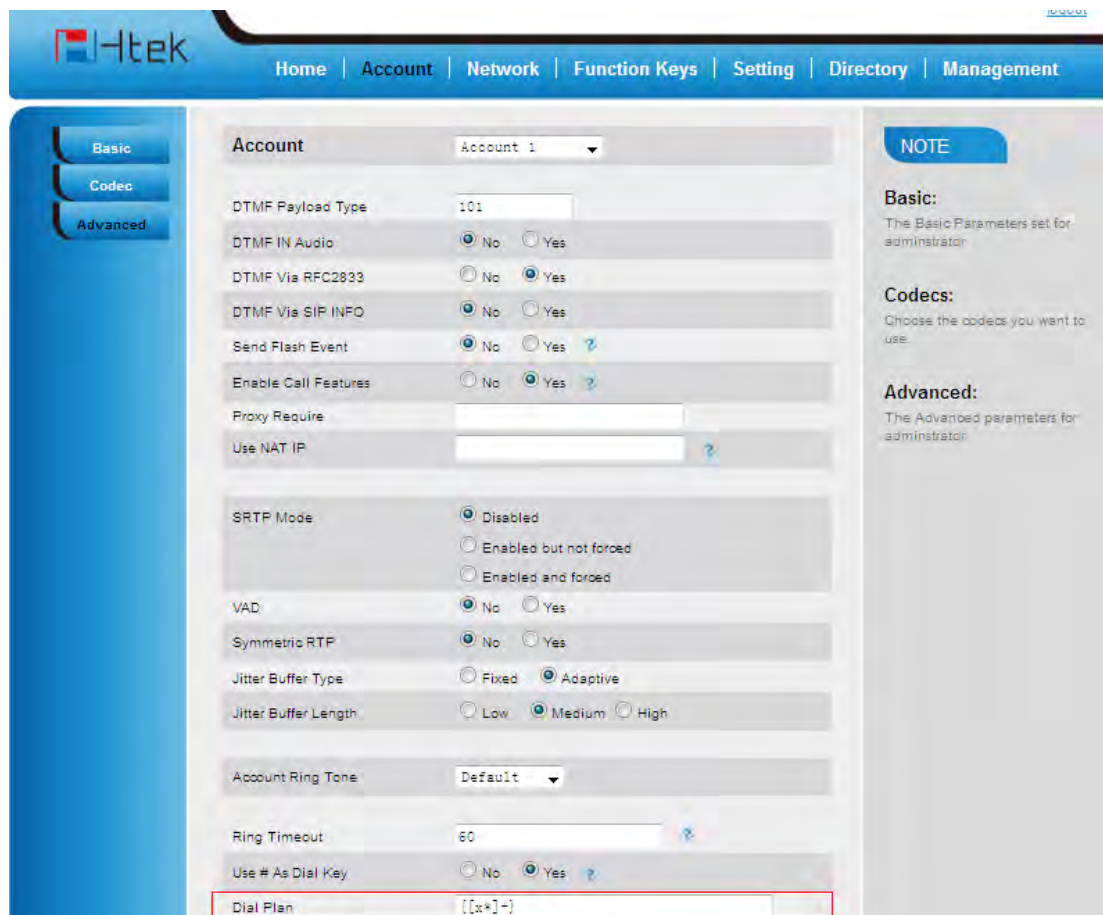

Note:
 Illegal input will fall back to default: {[x*]+}. For More, please refer to [dial plan](http://www.h-tek.com) on www.h-tek.com

Emergency Call

Public telephone networks in countries around the world have a single emergency telephone number (emergency services number), that allows a caller to contact local emergency services for assistance when required. The emergency telephone number may differ from country to country. It is typically a three-digit number so that it can be easily remembered and dialed quickly. Some countries have a different emergency number for each of the different emergency services. You can specify the emergency telephone numbers on the IP phone for contacting the emergency services in an emergency situation.

To configure emergency call via web interface:

1. Click Setting→Features→Phone Lock
2. Enter the emergency services number in the Emergency field
3. Click **SaveSet** to save the configuration.

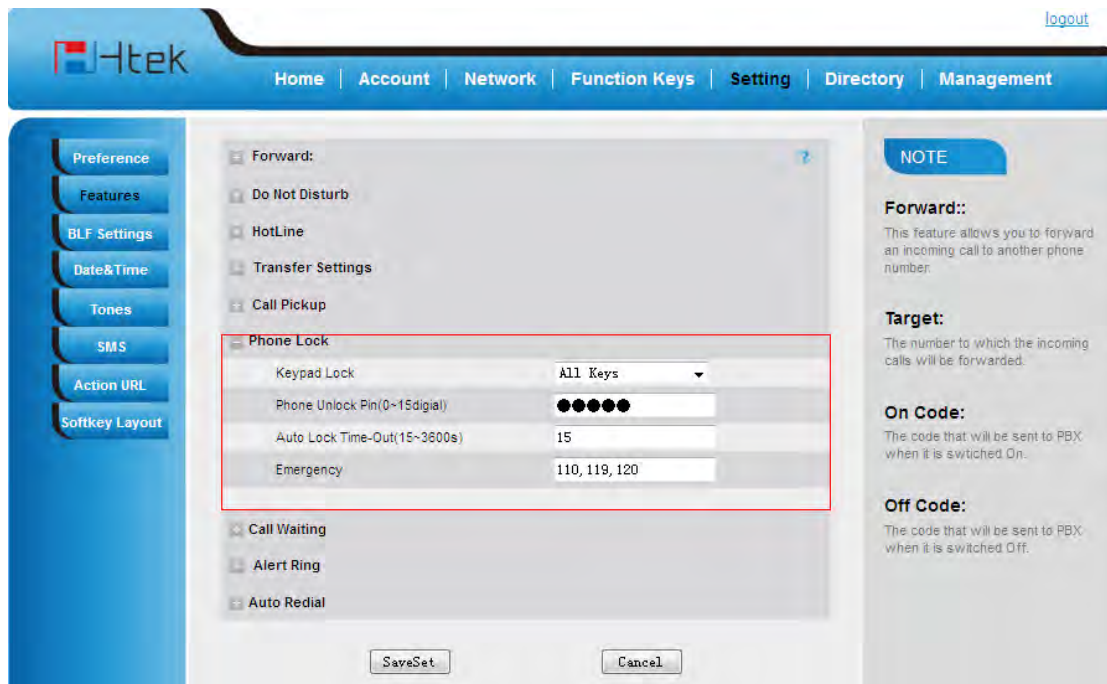

LED Status Setting

The LED Status setting mainly defines the power indicator LED.

To configure LED Status via web interface:

1. Click Setting→Preference
2. Select Yes or No for Power Status, Ringing Status, Miss Calls Status and Voice Message Status.
3. Click **SaveSet** for the setting.

For the LED status description, see: LED Instruction [Power Indicator LED](#)

LED Status Setting:

Power Status	<input checked="" type="radio"/> Yes	<input type="radio"/> No
Ringing Status	<input checked="" type="radio"/> Yes	<input type="radio"/> No
MissCalls Status	<input type="radio"/> Yes	<input checked="" type="radio"/> No
Voice Message Status	<input type="radio"/> Yes	<input checked="" type="radio"/> No

Action URL

To configure action url via web interface:

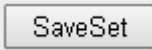
1. Click Setting→Action URL
2. Filled the needed value in the necessary blank.
3. Click  to save the setting.

Click [Action URL](#) for more how to use, or check on www.h-tek.com

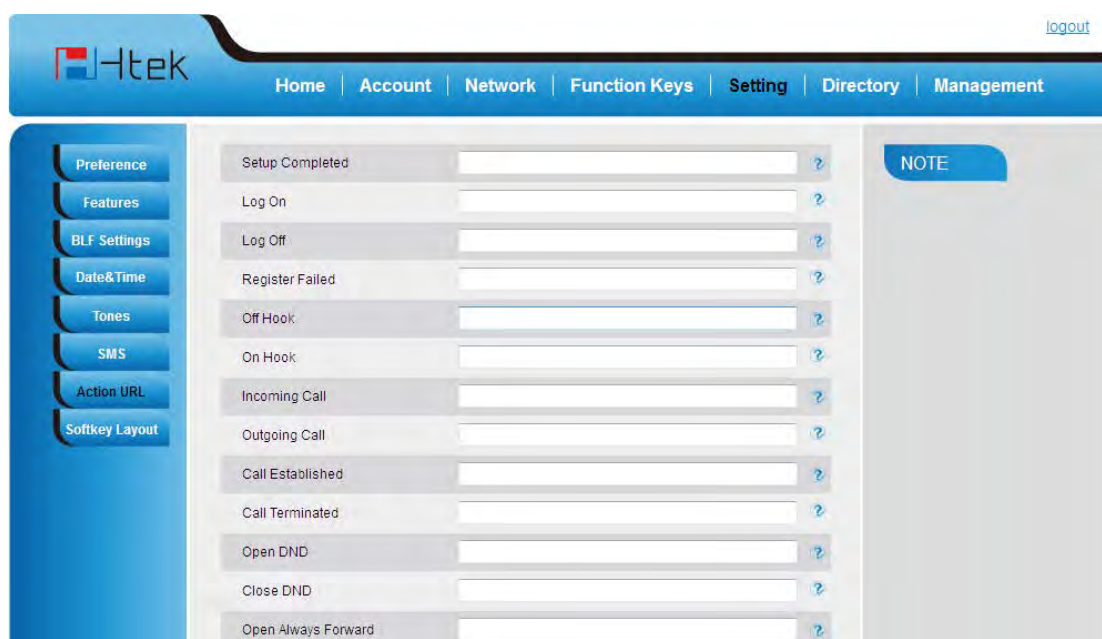

The screenshot shows the Htek web interface. At the top right, there is a "logout" link. Below the header, a navigation menu includes "Home", "Account", "Network", "Function Keys", "Setting", "Directory", and "Management". On the left side, a vertical menu lists various settings categories: "Preference", "Features", "BLF Settings", "Date&Time", "Tones", "SMS", "Action URL", and "Softkey Layout". The "Action URL" category is selected and highlighted. The main content area displays a list of settings, each with a text input field and a help icon (question mark):

- Setup Completed
- Log On
- Log Off
- Register Failed
- Off Hook
- On Hook
- Incoming Call
- Outgoing Call
- Call Established
- Call Terminated
- Open DND
- Close DND
- Open Always Forward

On the right side of the configuration area, there is a "NOTE" section.

Softkey Layout

This feature mainly defines which shown on the soft key in some status. For example, what the soft key displays when dialing, or talking.



To configure Soft key via web interface:



1. Click Setting→Softkey Layout

2. Select Enable for Custom Softkey

3. Select call States.

4. Select the feature form the disable key to enable key field by 

 Disable to Enable field.  Delete the Enable, and it will back to Disable field.

5. Click  or  to change to position or each feature.

6. Click  to save the configuration.

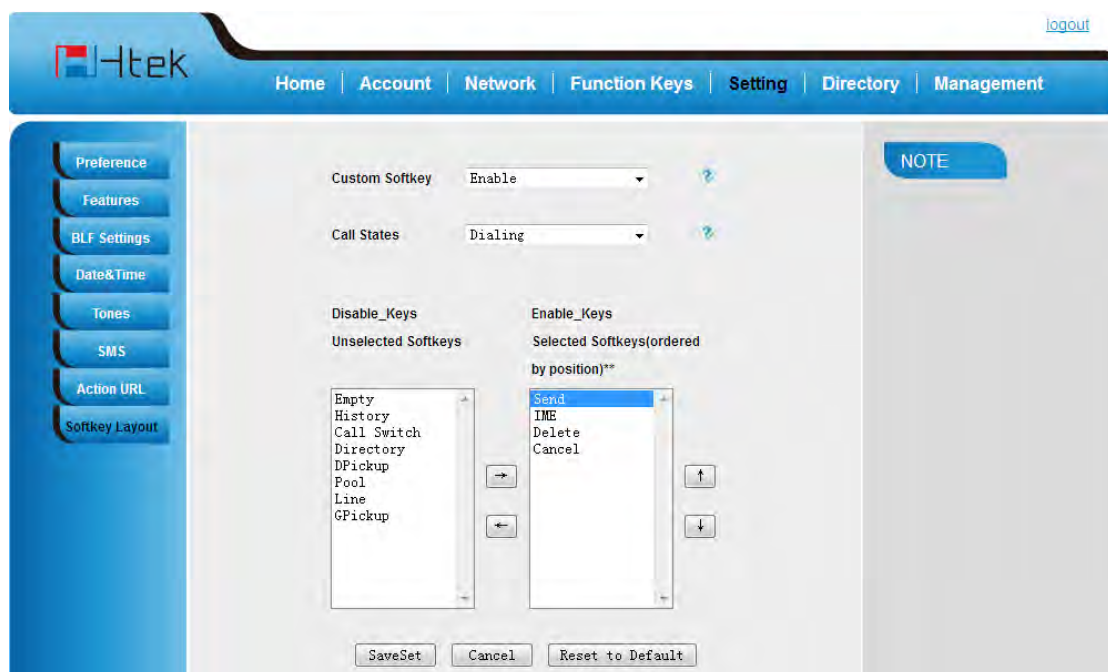



Note:

1. When there more than 5 items in the Enable field, the last softkey will display More, and last two item will show in the next page softkey, you can check by press more.

Programmable Key

For the default keys as Soft keys, Navigation keys and so on, you can define them as some specific feature, and it works only on the idle page.

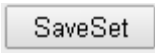
To configure Programmable Key via web interface:

1. Click Function Keys→Programmable Keys
2. Select the desired Key to set.
3. Click  to save the setting.
4. By clicking , all setting of the keys will be back to default.

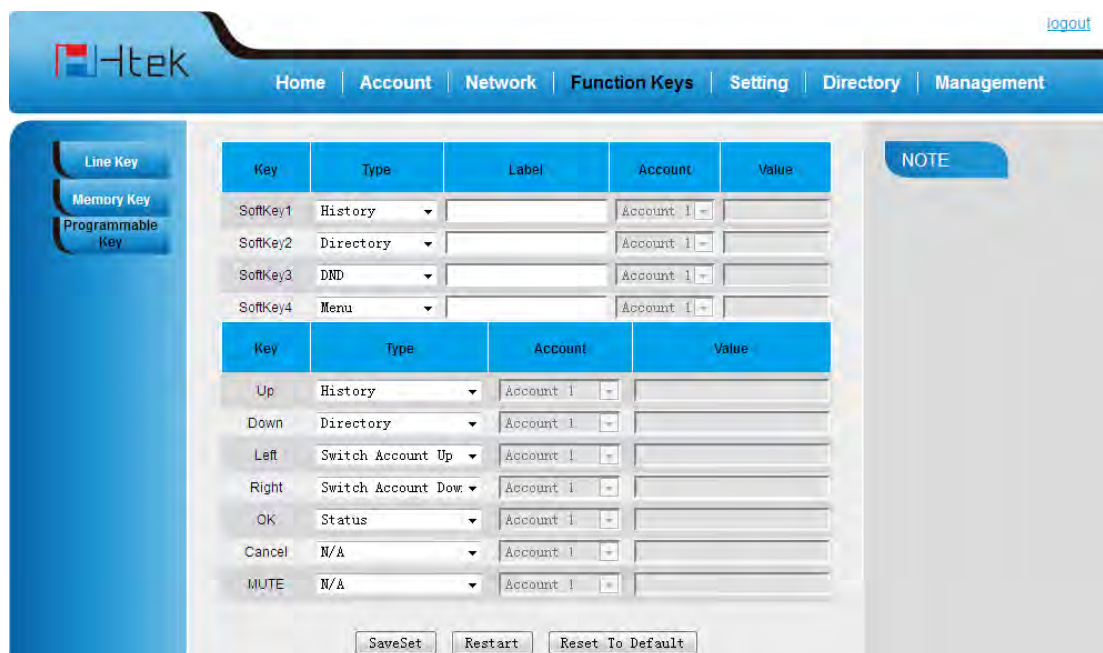

Basic Call Features



Place a Call

There are three ways to dialing a call: Handset, Headset and Hands-free speakerphone.

To place a call by Handset

1. Pick up the handset, or press a line key and dial the necessary number.
2. Press  or press the send softkey, then the call is sending.

To place a call by Headset:



1. Press the  (light is Green)
2. Enter the desired number.
3. Press  or press the Send softkey, then the call is sending.

Using headset to place and answer calls for all time



1. Click webpage Setting →Preference
2. HeadSet Priority →Enable
3. Ring Device For HeadSet →User Headset
4. Press 

Refresh Caller Id Via Contact	Disable
HeadSet Priority	Enable
Ringer Device For HeadSet	Use Speaker
Redial Mode	<input checked="" type="radio"/> Direct Mode <input type="radio"/> Select Mode
Intercom Barge	<input type="radio"/> On <input checked="" type="radio"/> Off ?
Show Missed Calls	<input checked="" type="radio"/> Yes <input type="radio"/> No ?
Suppress DTMF Display	<input type="radio"/> Off <input checked="" type="radio"/> On
Suppress DTMF Display Delay	<input type="radio"/> Off <input checked="" type="radio"/> On
Voice Mail Tone	<input checked="" type="radio"/> On <input type="radio"/> Off
Busy Tone Timer (0~5s)	4

Placing a call by hands-free speakerphone

1. Press the , or press the Line key, then you can hear the dial tone.
2. Press the number.
3. Press  or press the Send soft key, then the call is sending.

To place a call by call history or Directory

1. Press the History soft key (On the idle page) or Menu → History /Directory
2. Press  and  to select the targeted one.
3. Press Send soft key to make the call.

Note:

1. The  key is set to be a send key. For more information, refer to the Key as Send on page.
2. During the call, you can also change among Headset, Handset or Free-speaker mode.

Making two calls with one line and one account

1. Press a line key and dial one phone number, then make a call.
2. Press the corresponding line key
3. Dial another phone number,
4. Press the Send soft key, or , then make the second call.



End a Call

Here shows to end a call during three modes:



To end a call by Handset

Press the Cancel soft key or hang up the handset, or press .

To end a call under Headset Mode

Press the Cancel soft key or press , or press .

To end a call under hands-free speakerphone Mode

Press the Cancel soft key or press , or press .

Note: During the conference, to end the call is same as mentioned above.

Receive a Call

There are three ways to receive a call when the phone is ringing:

To receive a call by handset

Pick up the handset the conversation is built.

To receive a call by headset

Press  and now the conversation is built.

To receive a call by hands-free speaker

1. Option 1: Press  directly.
2. Option 2: Press Answer soft key.
3. Option 3: Press the Line key (flashes red).

Moreover, some other action can be done by soft key when the call is coming.

1. To press the Reject soft key to reject the call. Or press  to reject the current call.
2. To press Forward to forward to another phone.
3. To press Silence soft key, and then the call will keep silent, no ring tone display.

Incoming Call Show Mode

There are two incoming call show mode for this phone:

1. name and number of the contacts
2. name and number of the incoming call and the account which is connecting

To set incoming call show mode via web interface:

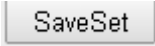
1. Click setting → preference
2. Select the desire mode for the incoming call show mode
3. Click  to save the setting.

LED Status Setting:		
Power Status	<input checked="" type="radio"/> Yes	<input type="radio"/> No
Ringing Status	<input checked="" type="radio"/> Yes	<input type="radio"/> No
MissCalls Status	<input type="radio"/> Yes	<input checked="" type="radio"/> No
Voice Message Status	<input type="radio"/> Yes	<input checked="" type="radio"/> No
Incoming Call Show Mode	<input checked="" type="radio"/> Peer Name & Peer Number	
	<input type="radio"/> Peer Name & Peer Number & Self Name	

Auto Answer

Enable auto answer feature, you will answer all incoming call automatically.

To enable Auto Answer via Webpage

1. To Click Account → Advanced
2. To choose Yes for the Auto Answer.
3. To click Saveset to save the configuration.

Send Anonymous	<input checked="" type="radio"/> No	<input type="radio"/> Yes	?
Anonymous Call Rejection	<input checked="" type="radio"/> No	<input type="radio"/> Yes	
Check SIP User ID	<input checked="" type="radio"/> No	<input type="radio"/> Yes	
Auto Answer	<input type="radio"/> No	<input checked="" type="radio"/> Yes	
Allow Auto Answer By Call-Info	<input type="radio"/> No	<input checked="" type="radio"/> Yes	
Turn off Speaker on remote disconnect	<input type="radio"/> No	<input checked="" type="radio"/> Yes	

To Disable Auto Answer via Webpage

1. To Click Account → Advanced
2. To choose No for the Auto Answer.
3. To click Saveset to save the configuration.

Call Hold

When use hold feature, the Hold icon will show on the display.

To make a call on hold during three modes:

To hold a call under handset mode:

1. Press Hold soft key to hold the current call.

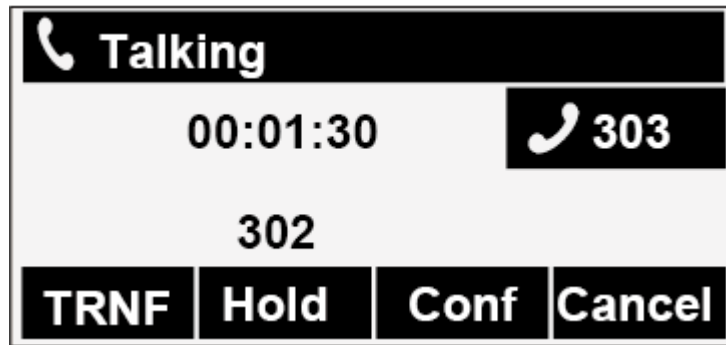

2. Press Resume soft key to resume the call on hold.

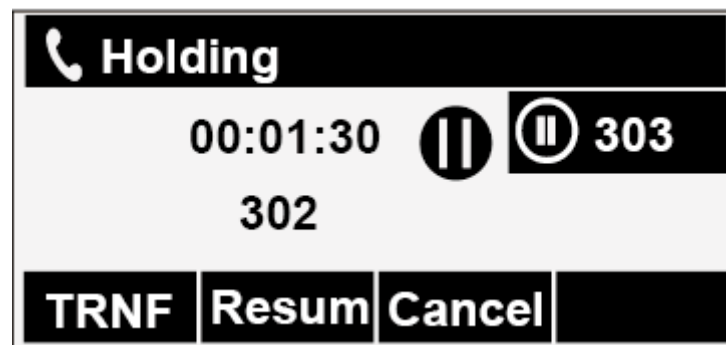

To hold a call under headset mode:

1. Press Hold soft key to hold the current call.
2. Press Resume soft key to resume the call on hold.

To hold a call during the speaker mode:

1. Press Hold soft key to hold the current call.
2. Press Resume soft key to resume the call on hold.

Call Transfer

This phone supports blind, attended and Semi-Attended Transfer.

Blind Transfer

When you use this feature, you can transfer

1. Press Transfer soft key during the conversation, the call is on hold now.

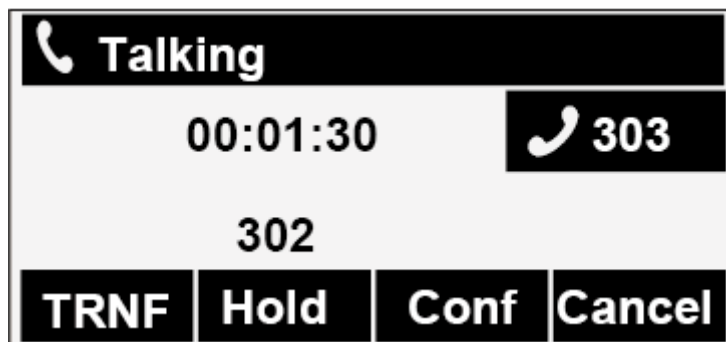

2. Enter the number that transfers to.



3. Press Transfer softkey , and now the blind transfer completed.

NOTE:

The “Enable Call Feature” must be configured to “Yes” to enable this feature (Account→Advanced).

Attended Transfer

When you use this feature, you can

1. Press transfer soft key during the conversation, the call is on hold now.
2. Enter the number that transfer to, and press the send soft key or .
3. Start the second conversation, press the transfer soft key, then, transfer completed.

NOTE:

To transfer calls across SIP domains, SIP service providers must support transfer across SIP domains. Blind transfer will usually use the primary account SIP profile.

Semi-Attended Transfer

1. Press the transfer soft key during the conversation, the call is on hold now.
2. Enter the number transfer to, and then press , then you can here the ring tone.
3. Press the Transfer soft key, and now the Semi-attended transfer completed.

BLF Transfer

1. Set a Programmable Key or line key is set as BLF. For how to set BLF, please refer to [BLF](#)
2. Press the transfer soft key during the conversation, the call is on hold now.
3. Press BLF key then realize blind, attended and Semi-Attended Transfer. (Webpage--Setting--Features)

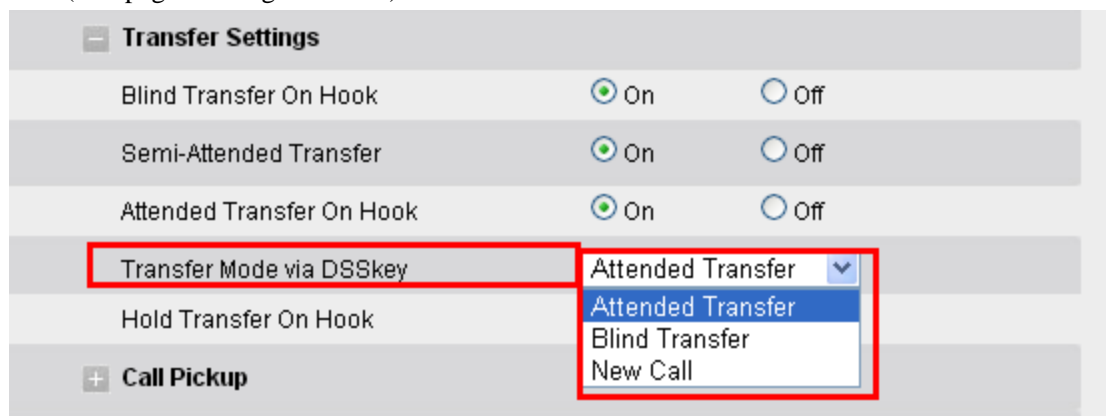

Hold transfer on hook:

1. Setting → Features → Transfer Setting: Hold Transfer On Hook: ON.
2. A place a call to B, B answer, A press the hold softkey and place a call to C, A cancel the call when C is ringing or answering, then C and B in the same call and the transfer is successful.

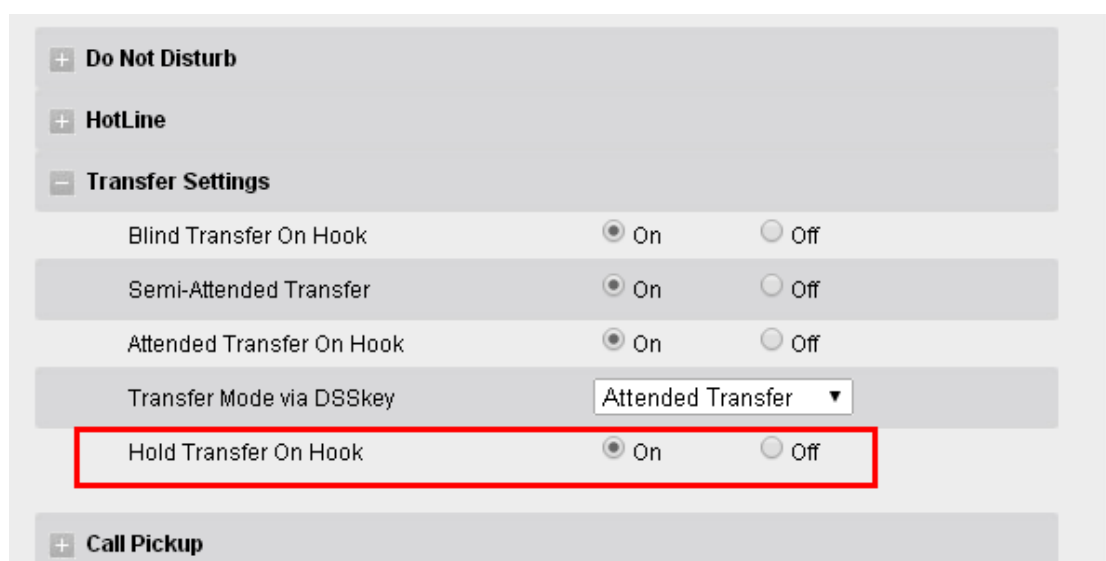

Transfer to New Call via web interface

1. Click Setting → Feature
2. Select Transfer Mode via DSS key → New Call
3. Select the desired Line or Memory key and select Transfer in the Type.
4. Enter the phone number in the Value field.

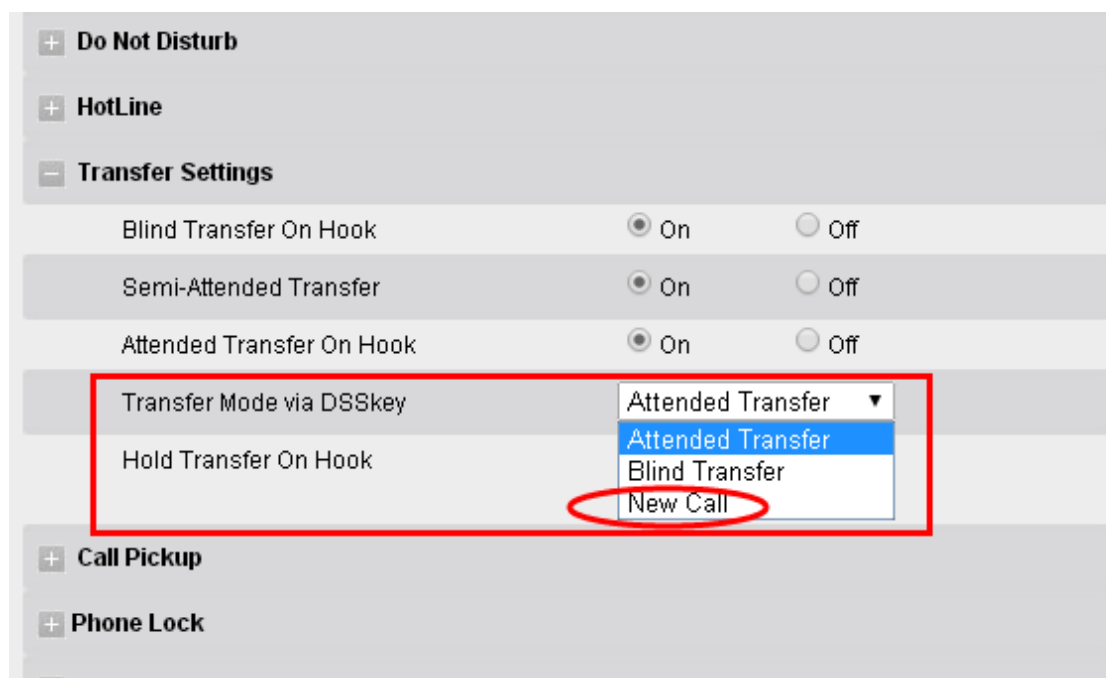

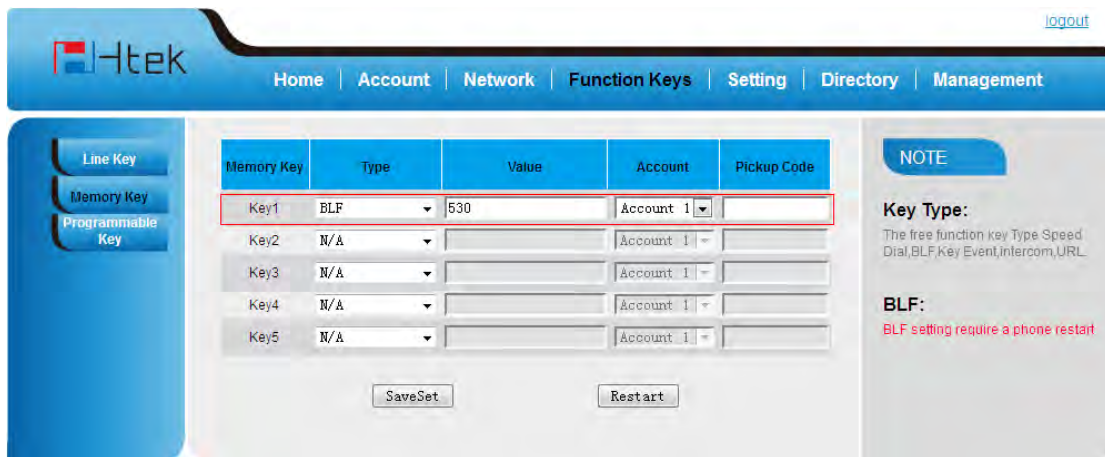

NOTE: if the person that wanted to be spoken to do not want to answer the call, then the person that answered the coming call could use this function.



Call Conference

This IP Phone supports up to 5-way conference.

5-way conference

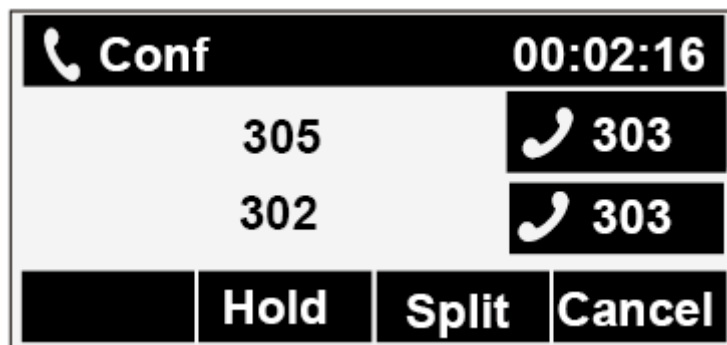
1. Assuming that call party A and B are in conversation. A wants to bring C, D and E in a conference
2. A press line 2 key, the call is placed on hold.
3. A enter the number of C and then press send soft key or .
4. C answering the call.
5. A press conference soft key, then A, B and C are now in a conference.(and now this is **3-way conference**)



6. A press line 3 key, the current 3-way conference is placed on hold.
7. A enter the number of D and then press send soft key or .
8. D answering the call.
9. A press the conference soft key, then A, B, C and D are now in a conference.(and now this is **4-way conference**)
10. A press line 4 key, the call is placed on hold.
11. A enter the number of E and then press send soft key or .
12. E answering the call.
13. A press the conference soft key, then A, B, C, D and E are now the **5-way conference** is built.
14. A end the call, the conference is finished.

Note:

1. If C does not answer the call, A can back to continue the conversation with B;
2. Once A hangs up the call, the conference is ended, while if B or C drops the call, A&C or A&B conversation continues.
3. The conference feature is not available on all servers. For more information, contact your system administrator.
4. To realize the 5 way conference, the line should be all available.



Call Forward

This phone supports static forward (always forward, busy forward and no answer forward) and dynamic forward

To configure static forward

With this feature, all incoming calls will forward immediately to configured number.

1. Press Menu → Features → Call forward → Always Forward.

2. Press  and  or press info soft key to select the enable choice





3. Enter the forward to number and on code (optional), off code (optional).

4. Press  or Save soft key to save the configuration.

To configure busy forward

With this feature, the incoming calls are immediately forwarded if the phone is busy.

1. Press Menu → Features → Call forward → Busy forward.

2. Press  and  or press info soft key to select the enable choice.



3. Enter the forward to number and on code (optional), off code (optional).

4. Press  or Save soft key to save the configuration.

To configure no answer forward

No Answer Forward: Incoming calls are forwarded if not answered after some time.

1. Press Menu → Features → Call forward → No answer forward.

2. Press  and  or press info soft key to select the enable choice

3. Enter the forward to number and on code (optional), off code (optional).

4. Press  or Save soft key to save the configuration.



When the Forward feature is enabled, the Forward Icon will display on Top of the LCD.

To configure Forward via Web Interface

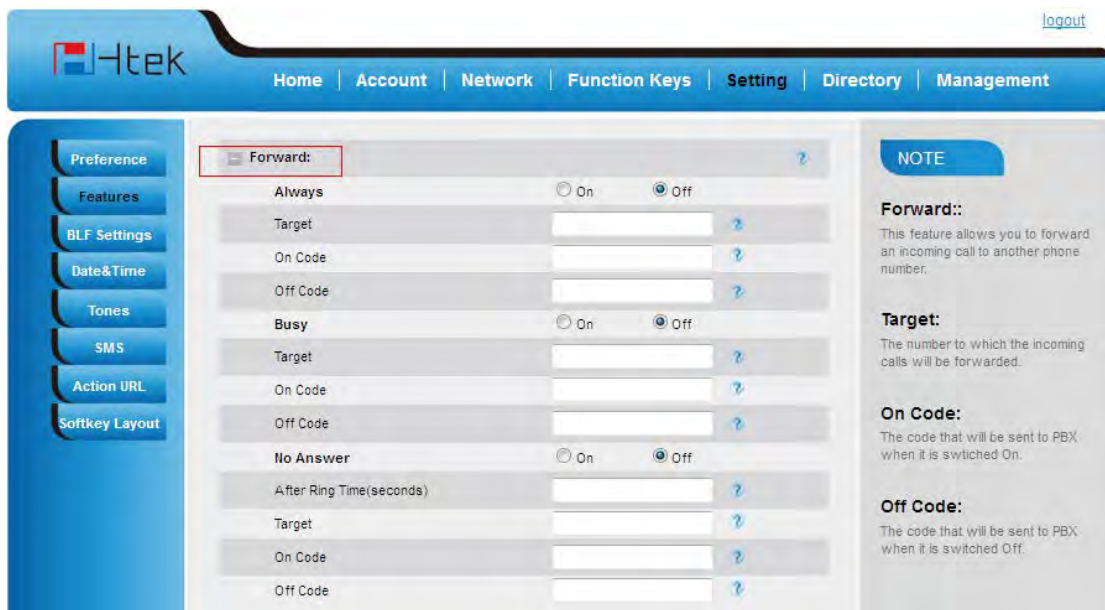
1. Setting → Features
2. Click On for the Always/Busy/No Answer
3. Fill the Forward to Number
4. (Optional) fill the on/off code
5. Click SaveSet to save the configuration



To cancel the forward feature via Phone Interface

1. Press Menu → Features → Call forward → Always/Busy/No answer Forward
2. Press  and  or press info soft key to select the disable choice
3. Press  or Save soft key to save the configuration.

To cancel the forward feature via Web Interface

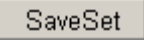
1. Setting → Features
2. Click Off for the Always/Busy/No Answer
3. Click  to save the configuration

To configure dynamic forward

Forward an incoming call during the ringing.

1. When the phone is ringing, press Forward soft key.



2. Enter the forward number.
3. Press  or press the send soft key, then the call is forwarded.



Note:

If the Programmable Key or line key is set as BLF, when an incoming call ringing, press this BLF key directly to realize the dynamic forward.

Call Return

This feature allows you to dial the last phone call you received.

To configure the Call Return via phone interface

1. Press Menu → Features → Function Keys → Line or Memory keys as Function Keys → Memory key1(for example)
2. Select the wanted Line or Memory key.
3. Press  and  or press info soft key to select the Key Event in the type field.

4. Press and or press info soft key to select the Call Return.
5. Press or Save soft key to save the configuration

To configure the Call Return via Web interface

1. Click Function keys → Line or Memory key.
2. Select the desired Line or Memory key and select Call Return in the Type.
3. Click the to save the configuration.

Call Waiting Tone

1. Click Setting → Features
2. Select Call Waiting: On and Call Waiting Tone: On

The screenshot shows the Htek web interface. The top navigation bar includes 'Home', 'Account', 'Network', 'Function Keys', 'Setting', 'Directory', and 'Management'. The left sidebar has 'Preference', 'Features', 'BLF Settings', 'Date&Time', 'Tones', 'SMS', 'Action URL', and 'Softkey Layout'. The main content area shows settings for 'Forward:', 'Do Not Disturb', 'HotLine', 'Transfer Settings', 'Call Pickup', 'Phone Lock', 'Call Waiting', 'Alert Ring', and 'Auto Redial'. The 'Call Waiting' and 'Call Waiting Tone' options are highlighted with a red box. The 'Call Waiting' option is set to 'On' and 'Call Waiting Tone' is also set to 'On'. The 'NOTE' section on the right provides information about the 'Forward::' feature, 'Target:', 'On Code:', and 'Off Code:'.

To Change the Call Waiting Tone time via Web interface

1. Click Setting → Tones

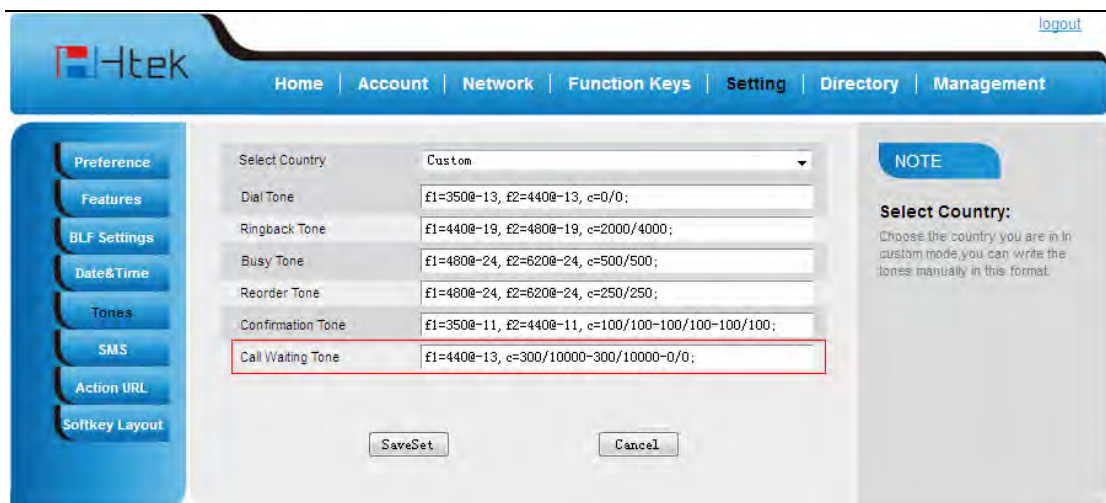

2. Change the Tone Time as you want (for example 3s)

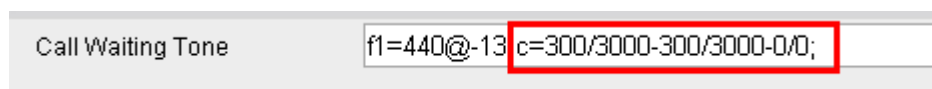

Anonymous Call



Just enable the anonymous call feature, you can set your ID do not appear on the other phone that you called.

To configure anonymous call

1. Press Menu → Features → Anonymous Call
2. Press and or press info soft key to change the Line ID
3. Press and or press info soft key to select the enable choice in Anonymous Call filed.
4. Enter the call on code (optional), call off code (optional).
5. Press or Save soft key to save the configuration.

To cancel anonymous call feature





1. Press Menu → Features → Anonymous Call

-
2. Press  and  or press info soft key to select the disable choice in Anonymous Call filed.
 3. Press  or Save soft key to save the configuration.



Reject Anonymous

If you do not want to be disturb by anonymous calls, you can set the reject anonymous call features, so you will not hear the unknown calls

To configure rejecting anonymous call

1. Press Menu → Features → Anonymous Call
2. Press  and  or press info soft key to change the Line ID
3. Press  and  or press info soft key to select the enable choice in Rejection filed.
4. Press  or Save soft key to save the configuration

To cancel rejecting anonymous call

1. Press Menu → Features → Anonymous Call
2. Press  and  or press info soft key to select the disable choice in Rejection filed.
3. Press  or Save soft key to save the configuration.

Call Mute

When you use the Mute feature, the other parties will not hear your voice while you can hear their voice. Call mute applies to all modes (handset, headset, and speakerphone).

To mute the call during a call (including a conference call)

1. Press the mute key , then the mute key glows green, and the LCD display Mute Icon.

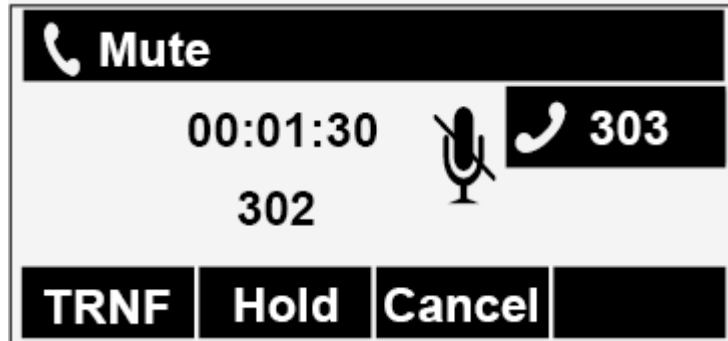

2. To disable the mute function, press  again.

DND

When you use the DND feature, the phone is to reject all incoming calls automatically and you can see the DND icon shown on the Top of the LCD on idle page.

To enable DND feature



Press the DND soft key when the phone is idle, and then DND icon shown on the LCD.

To disable DND feature



Press the DND soft key again, and then there is no DND icon on the LCD.

Key as Send

To configure Key as Send

1. Press Menu → Features → Key as Send
2. Press  and  or press info/switch soft key to select the enable choice.
3. Press  or Save soft key to save the configuration

To cancel # Key as Send

1. Press Menu → Features → Key as Send
2. Press  and  or press info/switch soft key to select the disable choice.
3. Press  or Save soft key to save the configuration.

No Key Entry Timeout

No Key Entry Timeout means that when you enter the number, it will dial out automatically after some time when you stop enter the number.

To configure No Key Entry Timeout

1. Click Webpage Setting → Preference
2. Fill the blank of No Key Entry Timeout: for example 5(seconds).(0 means never timeout, you should press the send key the dial out the number.
3. Click the  button to save the configuration.

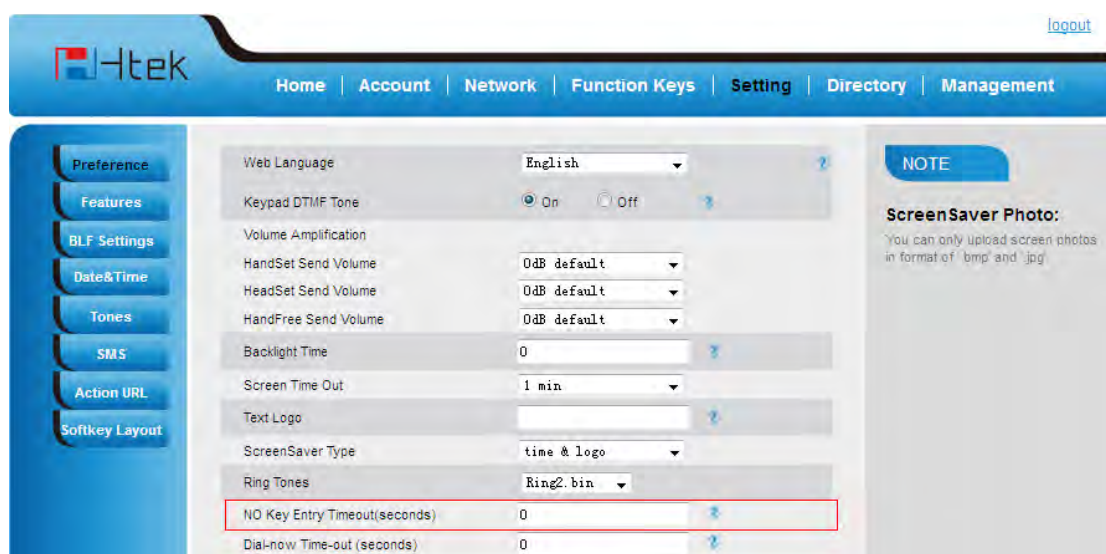

The screenshot shows the Htek web interface with the 'Preference' settings page. The 'NO Key Entry Timeout(seconds)' field is highlighted with a red box and set to 0. Other settings include Web Language (English), Keypad DTMF Tone (On), Volume Amplification, HandSet Send Volume, HeadSet Send Volume, HandFree Send Volume, Backlight Time (0), Screen Time Out (1 min), Text Logo, ScreenSaver Type (time & logo), Ring Tones (Ring2. bin), and Dial-now Time-out (seconds) (0). A 'NOTE' section on the right states: 'ScreenSaver Photo: You can only upload screen photos in format of 'bmp' and 'jpg'.

Keypad Lock

To enable Keypad Lock via Phone

1. Press Menu--Settings--Advanced Setting--Phone Setting--Lock
2. Press Info or Switch to change choose lock type:All Keys Menu Key Function Key Lock & Answer
3. Press Save or OK key to save the configuration.

To enable Keypad Lock via Phone

1. Press Menu--Settings--Advanced Setting--Phone Setting--Lock
2. Press Info or Switch to change to choose Off.
3. Press Save or OK key to save the configuration.

To enable Keypad Lock via Webpage

1. Click Webpage Setting → Preference
2. To choose the Lock keys.
3. To fill the unlock PIN and auto lock time
4. Fill the Emergence Number, when the phone is Lock, only Emergency Number can be sent.
5. To click Saveset to save the configuration.

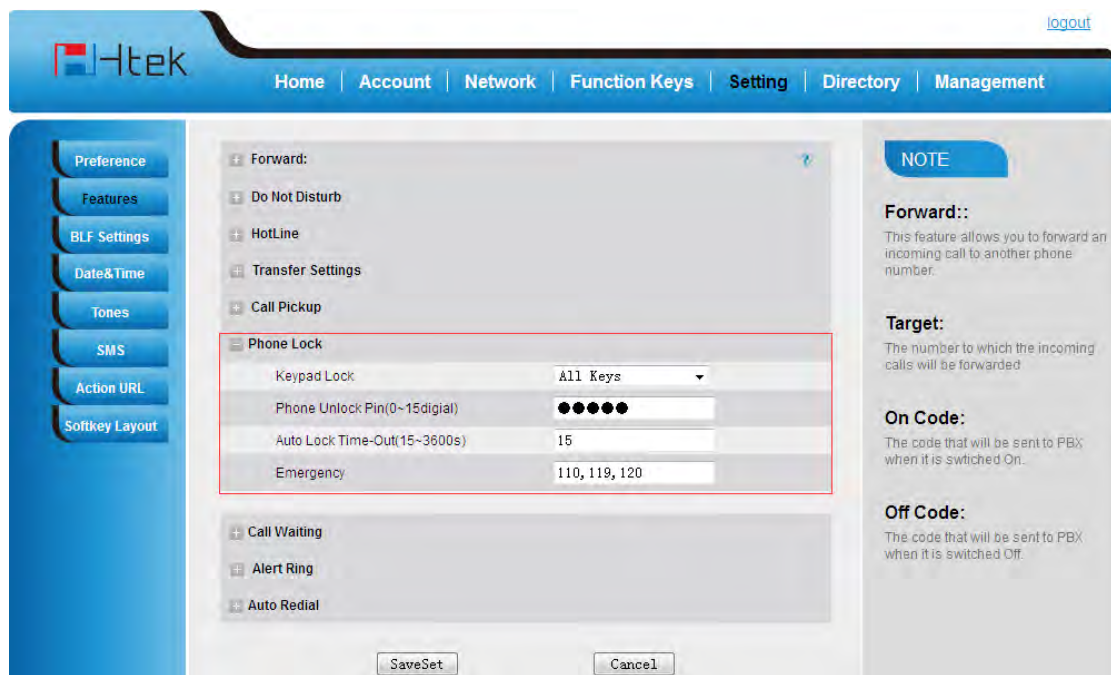

To Disable Keypad Lock via Webpage

1. Click Webpage Setting → Preference
2. To choose Disable for the Phone Lock.
3. To click Saveset to save the configuration.

Hot Line

To configure Hot Line

1. Press Menu → Features → Hot Line
2. Enter the Number and delay time (as present, we support off hook auto dial).
3. Press  or Save soft key to save the configuration

To configure Hotline auto dial via Web Interface

1. Setting → Features.

2. Fill the number in the Hotline Number and Hotline Time-out.

3. Click **SaveSet** to save the configuration.

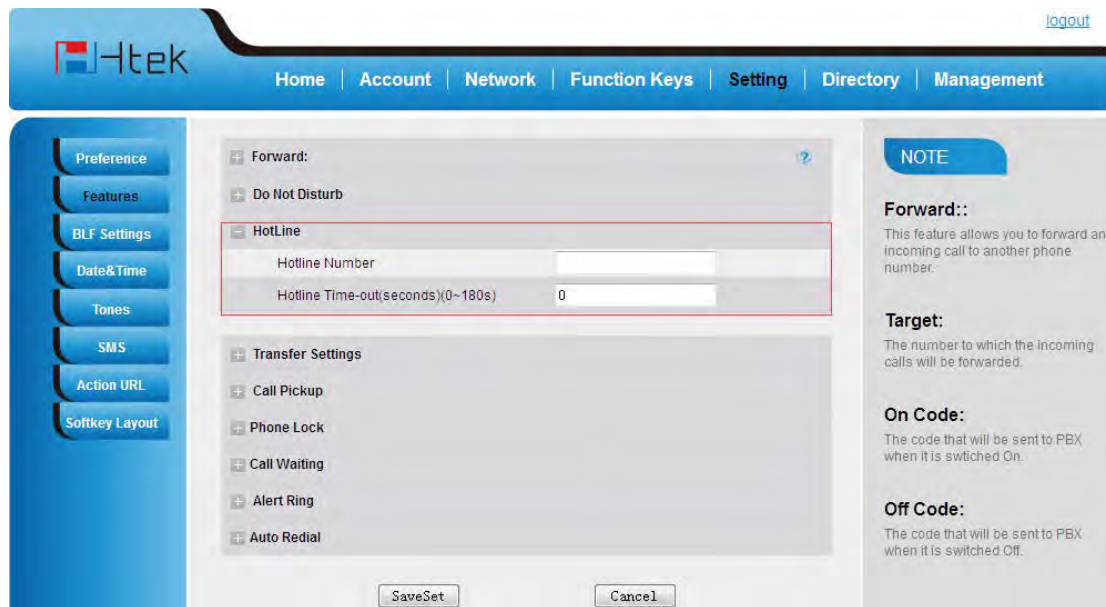

Delete the hotline number and save the configuration, and then now the Hotline auto dial is cancelled.

Function Key Features Settings

Line

It works same as Line keys.

To configure Line Feature via Web Interface

1. Click Function keys → Line or Memory Key.
2. Select the wanted Key and set as Line.
3. Select the Account.
4. Click the **SaveSet** to save the configuration.

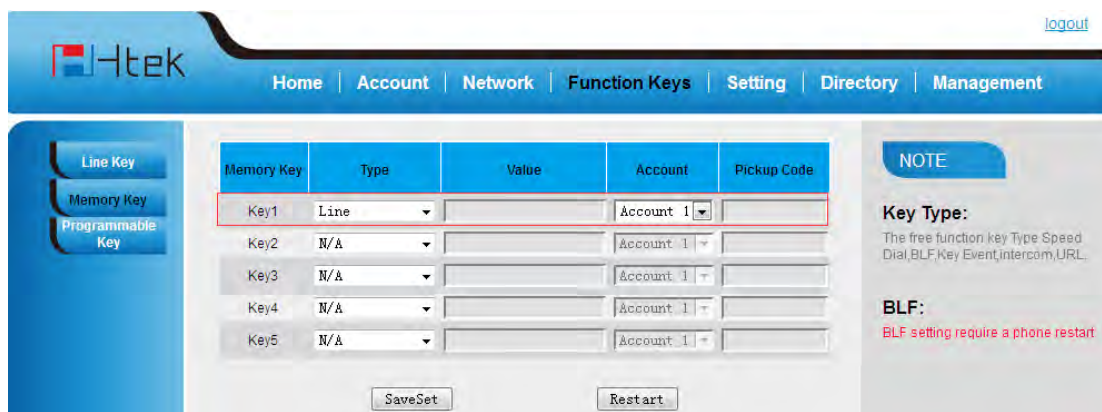

logout

Home | Account | Network | **Function Keys** | Setting | Directory | Management

Line Key
Memory Key
Programmable Key

Memory Key	Type	Value	Account	Pickup Code
Key1	Line		Account 1	
Key2	N/A		Account 1	
Key3	N/A		Account 1	
Key4	N/A		Account 1	
Key5	N/A		Account 1	

SaveSet Restart

NOTE



Key Type:
The free function key Type Speed Dial, BLF, Key Event, Intercom, URL.

BLF:
BLF setting require a phone restart

Speed Dial

With this feature, you can dial one directory by press the definite key.

To configure Speed Dial feature via phone interface

1. Press Menu → Features → Function Keys → Line or Memory keys as Function Keys → Memory key1 (for example)
2. Press  and  or press info soft key to select the Speed Dial in the type field.
3. Enter the targeted Number.
4. Press  or Save soft key to save the configuration

Then the selected Line or Memory key will work as Speed Dial.

To configure Speed Dial feature via Web Interface

1. Click Function keys → Line or Memory key.
2. Select the wanted Line or Memory key and set as Speed Dial.
3. Enter the desired phone number in the Value field.
4. Select the Account ID

- Click the **SaveSet** button to save the configuration.

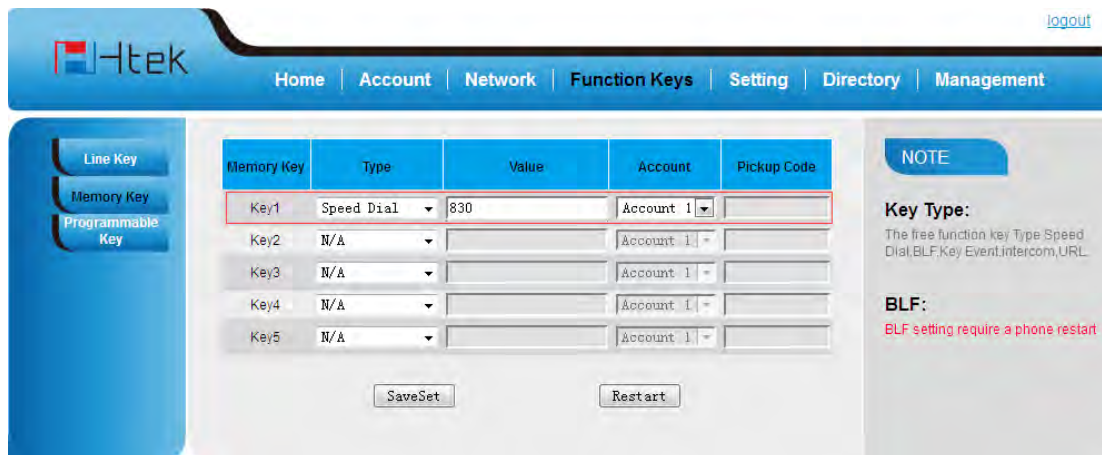

Memory Key	Type	Value	Account	Pickup Code
Key1	Speed Dial	830	Account 1	
Key2	N/A		Account 1	
Key3	N/A		Account 1	
Key4	N/A		Account 1	
Key5	N/A		Account 1	

NOTE

Key Type:
The free function key Type Speed Dial.BLF.Key Event,Intercom,URL





BLF:
BLF setting require a phone restart

BLF

You can use the BLF (Busy Lamp Field) feature to monitor a specific one whether his phone is busy or free.

- When the monitored line is idle, the light is steady green.
- When the monitored line is ringing, the light is blinking red, press the BLF key to pick the phone up directly.
- When the monitored line is calling or in a conversation, the light is steady red.

To configure a BLF key by phone

- Press Menu → Features → Function Keys → Line or Memory keys as Function Keys → Memory key1(for example).
- Select the targeted Line or Memory key.
- Press  and  or press infos soft key to select the BLF in the type field.
- Enter the targeted Value Number.
- Press  and  or press info soft key to select the Account ID.

6. Enter the Pickup Code.
7. Press  or Save soft key to save the configuration

To configure a BLF key by web

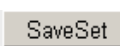
1. Click Function keys → Line or Memory key.
2. Select the desired Line or Memory key and select BLF in the Type.
3. Enter the monitored phone number in the Value field.
4. Select the Account ID
5. Filled the Pickup code.
6. Click the  button to save the configuration and then restart.

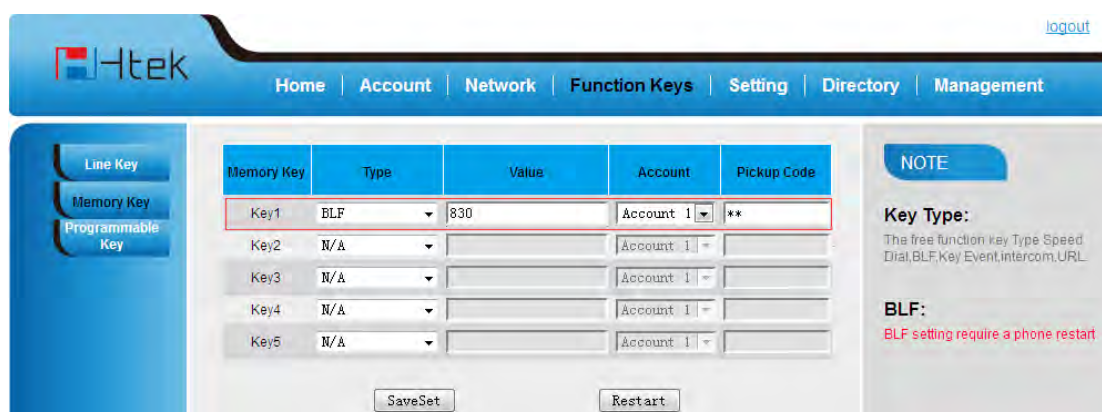

[logout](#)

Home | Account | Network | **Function Keys** | Setting | Directory | Management

Line Key
Memory Key
Programmable Key

Memory Key	Type	Value	Account	Pickup Code
Key1	BLF	830	Account 1	**
Key2	N/A		Account 1	
Key3	N/A		Account 1	
Key4	N/A		Account 1	
Key5	N/A		Account 1	

SaveSet Restart

NOTE

Key Type:
The free function key Type Speed Dial, BLF, Key Event, Intercom, URL

BLF:
BLF setting require a phone restart

Note:

This feature is not available on all servers. For more information, contact your system administrator.

After setting the BLF key, do not need to restart the phone.

BLF List

To configure BLF List via web interface:

1. Login and click Account

* Account Active	<input type="radio"/> No <input checked="" type="radio"/> Yes	
* Primary SIP Server	<input type="text" value="as.iop2.broadworks.net"/>	?
Failover SIP Server	<input type="text"/>	?
Second Failover SipServer	<input type="text"/>	?
Prefer Primary SIP Server	<input checked="" type="radio"/> No <input type="radio"/> Yes	?
Outbound Proxy	<input type="text"/>	?
* SIP Transport	<input checked="" type="radio"/> UDP <input type="radio"/> TCP <input type="radio"/> TLS	?
NAT Traversal	<input type="radio"/> No <input checked="" type="radio"/> No,but send keep alive <input type="radio"/> STUN	
Lable	<input type="text"/>	?
* SIP User ID	<input type="text" value="2404984031"/>	?
* Authenticate ID	<input type="text" value="2404984031"/>	?
* Authenticate Password	<input type="password" value="*****"/>	?
Name	<input type="text" value="4031"/>	?
DNS Mode	<input checked="" type="radio"/> A Record <input type="radio"/> SRV <input type="radio"/> NAPTR/SRV	

2. Click Advanced and then fill the Eventlist BLF URL.

UAC Specify Refresher	<input type="radio"/> UAC <input type="radio"/> UAS <input checked="" type="radio"/> Omit(Recommended)
UAS Specify Refresher	<input checked="" type="radio"/> UAC <input type="radio"/> UAS(When UAC did not specify refresher tag)
Force Invite	<input checked="" type="radio"/> No <input type="radio"/> Yes ?
Hook Flash Timing	minimum: <input type="text" value="30"/> maximum: <input type="text" value="100"/> ?
Special Feature	<input type="text" value="Standard"/>
Eventlist BLF URL	<input type="text" value="blf_sales"/>
Shared Line	<input type="text" value="Disable"/>
SIP Server Type	<input type="text" value="Default"/>

3. To configure BLF List Keys

3.1 Click → Function Keys → Memory Key

3.2 Select the BLF List in the Type Field.

3.3. Select Account

3.4 Click Saveset to save the configuration and then restart the Phone.

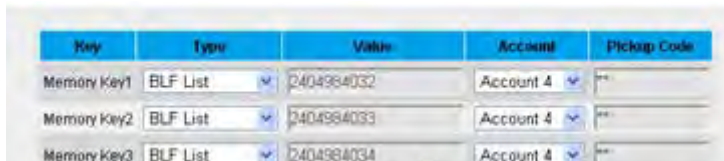

Key	Type	Value	Account	Pickup Code
Memory Key1	BLF List	2404984032	Account 4	**
Memory Key2	BLF List	2404984033	Account 4	**
Memory Key3	BLF List	2404984034	Account 4	**

For more information, please check [BLF list Note](#) on www.h-tek.com .

Voice Message

To configure the Voice mail feature

1. Press Menu → Messages → Voice Mail → Set Voice Mail.
2. Enter the Account1/2/3/4 NO.
3. Press  or Save soft key to save the configuration

Note:



This feature is not available on all servers. For more information, contact your system administrator.

Direct Pickup

With this feature, you can pick up the set line when it ringing.

To configure Direct Pickup feature via phone interface

1. Press Menu → Features → Function Keys → Line or Memory keys as Function Keys → Memory key1(for example)

2. Press  and  key to select the Speed Dial in the type field.
3. Enter the value.
4. Press  or Save soft key to save the configuration

Then the selected Line or Memory key will work as Direct Pickup.

To configure Direct Pickup feature via Web Interface

1. Click Function keys → Line or Memory key.
2. Select the wanted Line or Memory key and set as Direct Pickup.
3. Enter the pickup code and followed the desired phone number in the Value field.
4. Select the Account ID
5. Click the  to save the configuration.

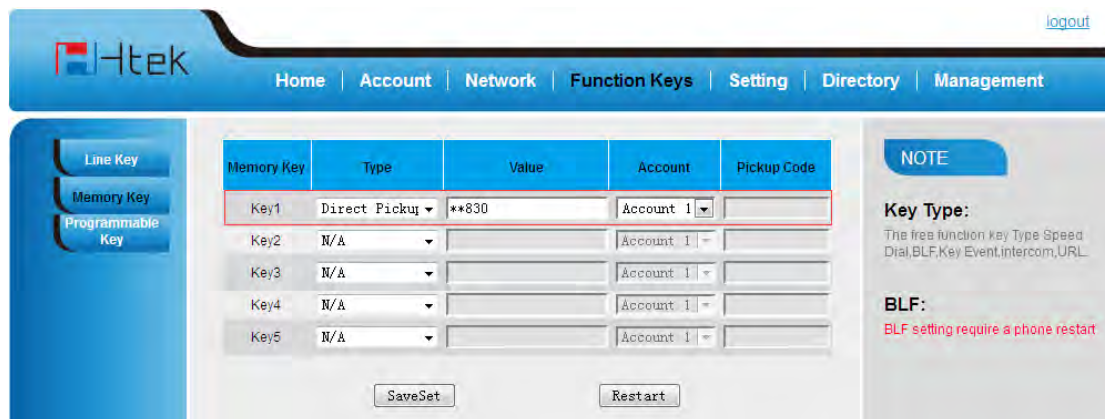



Memory Key	Type	Value	Account	Pickup Code
Key1	Direct Pickup	**830	Account 1	
Key2	N/A		Account 1	
Key3	N/A		Account 1	
Key4	N/A		Account 1	
Key5	N/A		Account 1	

Group Pickup

With this feature, you can pick up the specified group that you want incoming calls.

To configure the Pick up via phone interface

1. Press Menu → Features → Function Keys → Line or Memory keys as Function Keys → Memory key1 (for example)
2. Select the wanted Line or Memory key.
3. Press  and  key to select the Group Pickup in the type field.
4. Enter pickup code and followed the desired group number
5. Press  or Save soft key to save the configuration

To configure the Group Pick up via Web interface

1. Click Function keys → Line or Memory key.
2. Select the desired Line or Memory key and select Group Pickup in the Type.
3. Enter the pickup code and followed the desired Group number in the Value field.
4. Click the  to save the configuration.

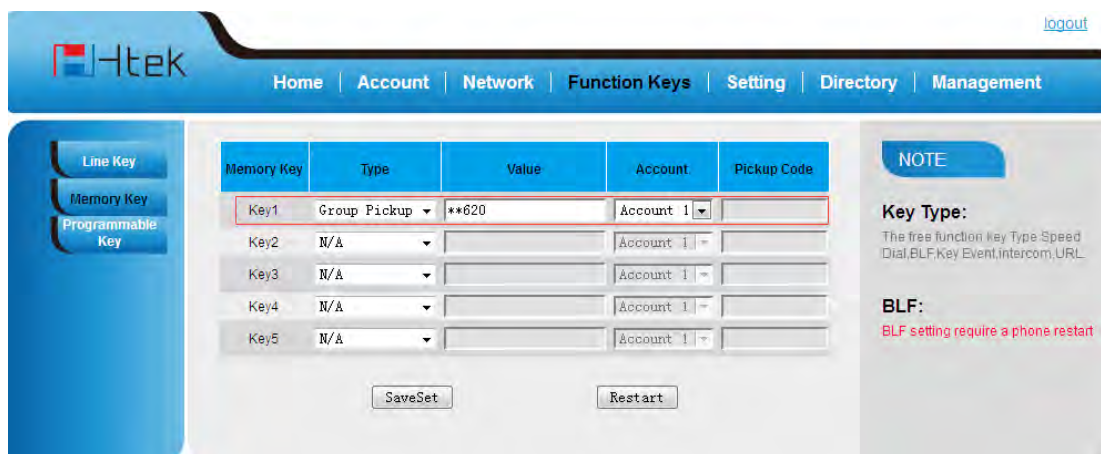

logout

Home | Account | Network | Function Keys | Setting | Directory | Management

Line Key
Memory Key
Programmable Key

Memory Key	Type	Value	Account	Pickup Code
Key1	Group Pickup	**620	Account 1	
Key2	N/A		Account 1	
Key3	N/A		Account 1	
Key4	N/A		Account 1	
Key5	N/A		Account 1	

NOTE

Key Type:
The free function key Type: Speed Dial, BLF, Key Event, Intercom, URL.



BLF:
BLF setting require a phone restart

SaveSet Restart

Call Park

With this feature, you can put a call on hold and continue the conversation from another phone.

To configure the Call Park via phone interface

1. Press Menu → Features → Function Keys → Line or Memory keys as Function Keys → Memory key1 (for example)
2. Press  and  or press Switch soft key to select the Call Park.
3. Press  or Save soft key to save the configuration

To configure the Call Park via Web interface

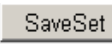
1. Click Function key → Line or Memory key.
2. Select the desired Line or Memory key and select Call park in the Type.
3. Enter the call park code in the value field.
4. Click the  button to save the configuration.

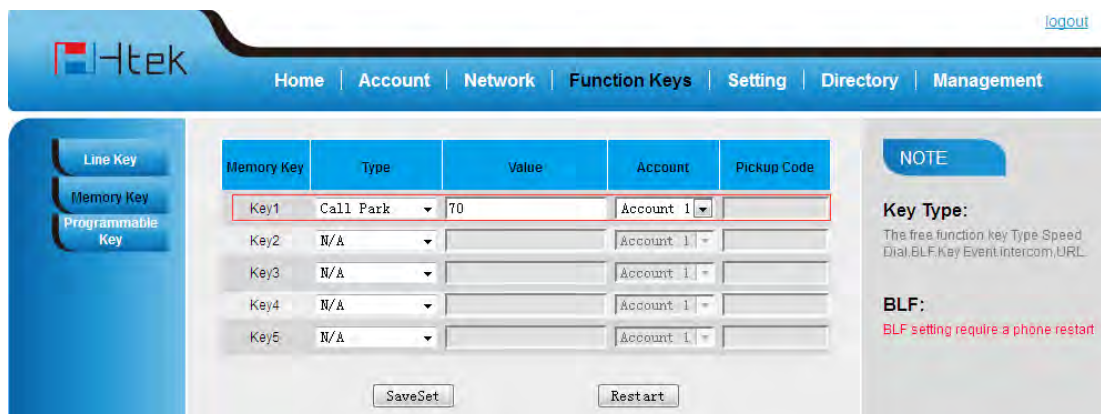

Memory Key	Type	Value	Account	Pickup Code
Key1	Call Park	70	Account 1	
Key2	N/A		Account 1	
Key3	N/A		Account 1	
Key4	N/A		Account 1	
Key5	N/A		Account 1	

NOTE



Key Type:
The free function key Type Speed Dial, BLF, Key Event, Intercom, URL.

BLF:
BLF setting requires a phone restart

Intercom

When use the intercom feature, you can quickly get access connect to the configured one.

To configure intercom feature via phone interface

1. Press Menu → Features → Function Keys → Line or Memory keys as Function Keys → Memory key1 (for example)
2. Press  and  or press info soft key to select the intercom in the type field.

3. Enter the targeted Number.
4. Press  or Save soft key to save the configuration

Then the selected Line or Memory key will work as intercom.

To configure Intercom feature via Web Interface

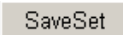
1. Click Function keys → Line or Memory key.
2. Select the wanted Line or Memory key.
3. Enter the desired phone number in the Value field.
4. Select the Account ID
5. Click the  button to save the configuration.

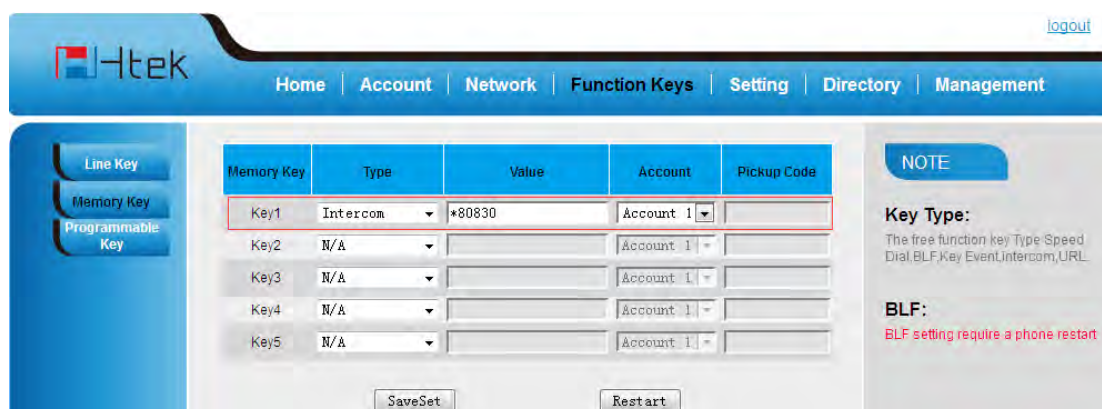

Memory Key	Type	Value	Account	Pickup Code
Key1	Intercom	*80830	Account 1	
Key2	N/A		Account 1	
Key3	N/A		Account 1	
Key4	N/A		Account 1	
Key5	N/A		Account 1	

NOTE

Key Type:
The free function key Type Speed Dial, BLF, Key Event, Intercom, URL.

BLF:
BLF setting require a phone restart

If you want to achieve the intercom feature, you must enable the “Allow Auto Answer By Call-Info”

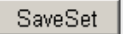
1. Click the account
2. Select the desired account from the pull-down list of Account in the Account field.
3. Click the advanced
4. Enable the “Allow Auto Answer By Call-Info”
5. Click the  button to save the configuration.



Send Anonymous	<input checked="" type="radio"/> No	<input type="radio"/> Yes	?
Anonymous Call Rejection	<input checked="" type="radio"/> No	<input type="radio"/> Yes	
Check SIP User ID	<input checked="" type="radio"/> No	<input type="radio"/> Yes	
Auto Answer	<input checked="" type="radio"/> No	<input type="radio"/> Yes	
Allow Auto Answer By Call-Info	<input type="radio"/> No	<input checked="" type="radio"/> Yes	

Note:

This feature is not available on all servers. For more information, contact your system administrator.

DTMF

To configure the DTMF via Phone Interface

1. Press Menu → Features → Function Keys → Line or Memory keys as Function Keys → Memory key1(for example)
2. Select the wanted Line or Memory key.
3. Press  and  or press info soft key to select the DTMF in the type field.
4. Enter the value
5. Press  or Save soft key to save the configuration

To configure the DTMF via Web interface

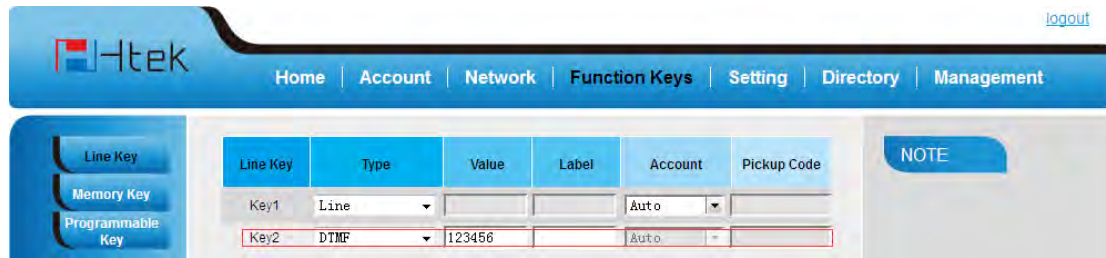

1. Click Function keys → Line or Memory key.
2. Select the desired Line or Memory key and select DTMF in the Type.
3. Fill the value.
4. Click the  to save the configuration.



Prefix

If the key is configured as Prefix key, you can set the number prefix (e.g. Before the number plus 9), then you don't input 9, press the key and 9 will display on the LCD interface.

To configure the Prefix via Phone Interface

1. Press Menu → Features → Function Keys → Line or Memory keys as Function Keys → Memory key1(for example)
2. Select the wanted Line or Memory key.
3. Press  and  key to select the Prefix in the type field.
4. Enter the value with with number that you want to set as prefix
5. Press  or Save soft key to save the configuration

To configure the Prefix via Web interface

1. Click Function key → Line or Memory key.
2. Select the desired Line or Memory key and select Prefix in the Type.
3. Fill the value.
4. Click the  button to save the configuration.

Then when you press this key, the set value is input directly.

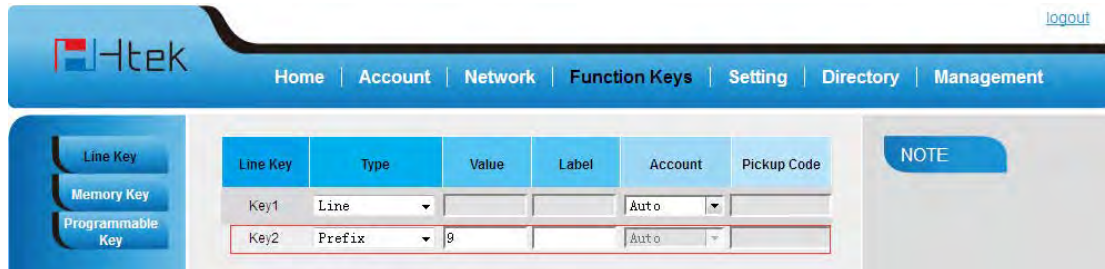



Line Key	Type	Value	Label	Account	Pickup Code
Key1	Line			Auto	
Key2	Prefix	9		Auto	

Local Group

When use the Local Group feature, press the key and enter the local Contacts interface quickly.

To configure the Local group via Phone Interface

1. Press Menu → Features → Function Keys → Memory keys as Function Keys → Memory key1 (for example)
2. Select the wanted Memory key.
3. Press  and  key to select the Local group in the type field.
4. Press  or Save soft key to save the configuration

To configure the Local Group via Web interface

1. Click Function key → Memory Key.
2. Select the desired Key and select Local group in the Type.
3. Click the  button to save the configuration.

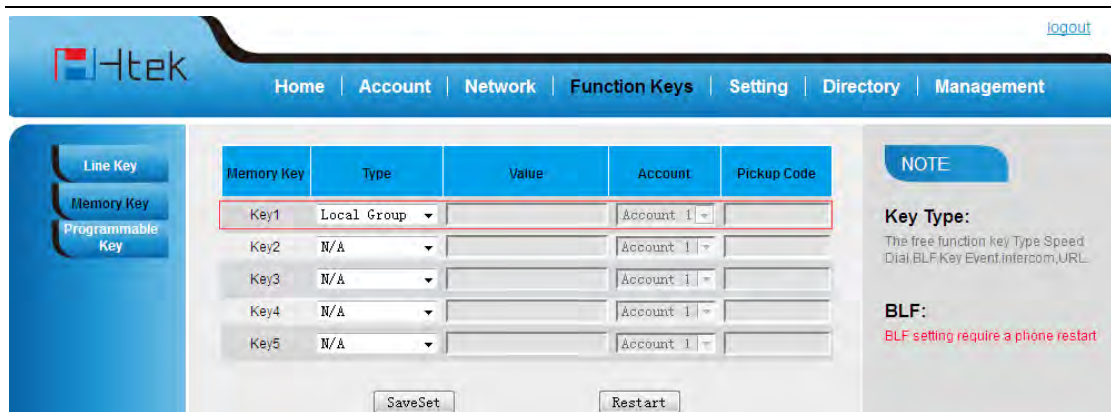

Then you can press the local group key to access the pre-defined contact group in the local directory quickly.



XML Group

When use the XML Group feature, press the key and enter the Remote Contacts interface quickly.

To configure the XML group via Phone Interface

1. Press Menu → Features → Function Keys → Memory keys as Function Keys → Memory key1 (for example)
2. Select the wanted Memory key.
3. Press  and  key to select the XML group in the type field.
4. Press  or Save soft key to save the configuration

To configure the XML Group via Web interface

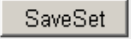
1. Click Function key → Memory Key.
2. Select the desired Key and select XML group in the Type.
3. Click the  to save the configuration.

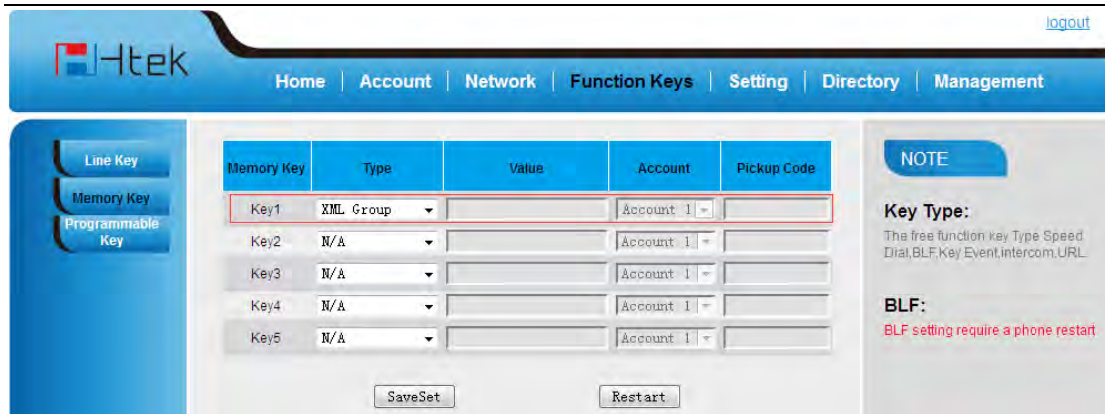

Memory Key	Type	Value	Account	Pickup Code
Key1	XML Group		Account 1	
Key2	N/A		Account 1	
Key3	N/A		Account 1	
Key4	N/A		Account 1	
Key5	N/A		Account 1	

NOTE



Key Type:
The free function key Type Speed Dial, BLF, Key Event, Intercom, URL

BLF:
BLF setting require a phone restart

LDAP

When use the LDAP feature, you can get the LDAP Phonebook directly.

To configure the LDAP via Phone Interface

1. Press Menu → Features → Function Keys → Memory keys as Function Keys → Memory key1 (for example)
2. Select the wanted Memory key.
3. Press  and  key to select the LDAP in the type field.
4. Press  or Save soft key to save the configuration

To configure the LDAP via Web interface

1. Click Function key → Memory Key.
2. Select the desired Key and select LDAP in the Type.
3. Click the  to save the configuration.

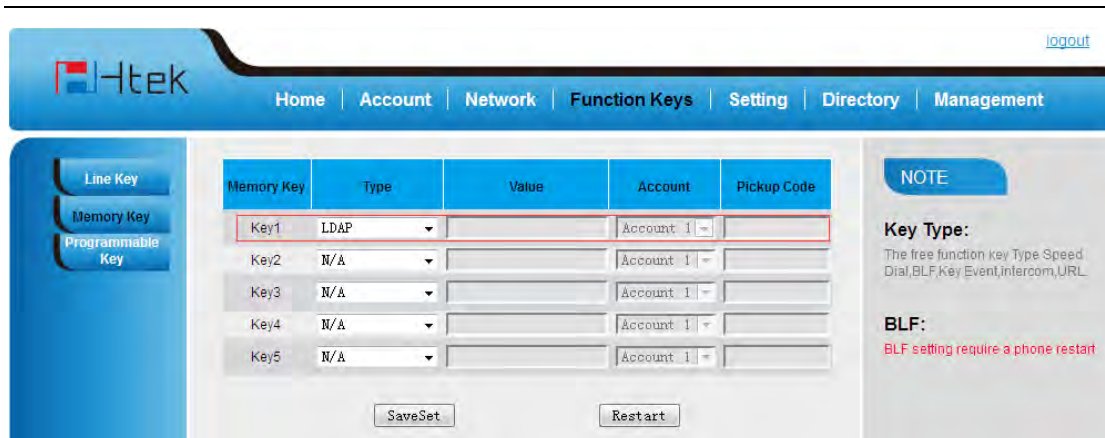

Memory Key	Type	Value	Account	Pickup Code
Key1	LDAP		Account 1	
Key2	N/A		Account 1	
Key3	N/A		Account 1	
Key4	N/A		Account 1	
Key5	N/A		Account 1	

NOTE



Key Type:
The free function key Type Speed Dial, BLF, Key Event, Intercom, URL

BLF:
BLF setting require a phone restart

XML Browser

You can use this key feature to access the Xml browser quickly. The Xml browser allows you to create custom services which meet your functional requirements on the server. You can customize practical applications, such as weather report, stock information, Google search, etc.

To configure the XML Browser via Phone Interface

1. Press Menu → Features → Function Keys → Memory keys as Function Keys → Memory key1 (for example)
2. Select the wanted Memory key.
3. Press  and  key to select the XML Browser in the type field.
4. Filled the access URL for xml browser
5. Press  or Save soft key to save the configuration

To configure the XML Browser via Web interface

1. Click Function key → Memory Key.
2. Select the desired Key and select xml browser in the Type.
3. Filled the access URL for xml browser (e.g. http://192.168.0.240:8080/xmlbrowser/text.xml)

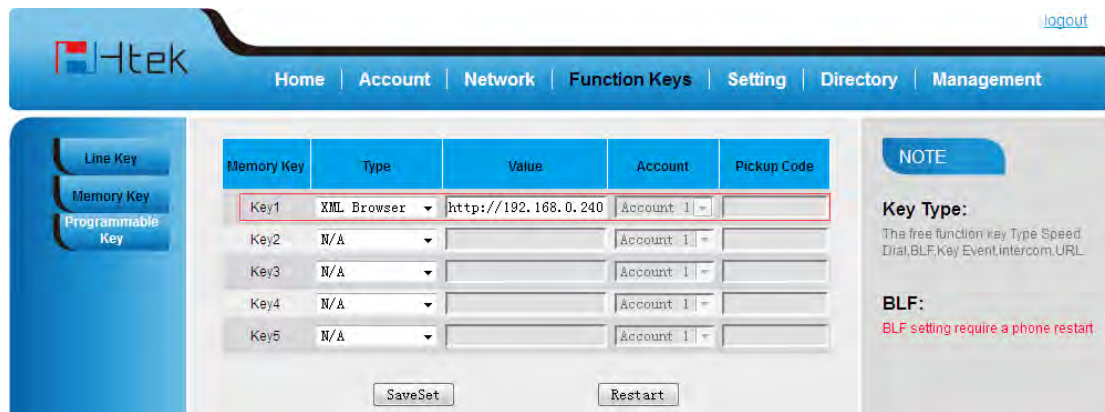

- Click the  button to save the configuration.



Broadsoft Group

When use the BroadSoft Group feature, press the key and enter the Remote Contacts interface quickly.

To configure the Broadsoft group via Phone Interface

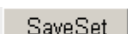

- Press Menu → Features → Function Keys → Memory keys as Function Keys → Memory key1 (for example)
- Select the wanted Memory key.
- Press  and  key to select the Broadsoft group in the type field.
- Press  or Save soft key to save the configuration

To configure the Broadsoft group via Web interface

- Click Function key → Memory Key.
- Select the desired Key and select Broadsoft group in the Type.
- Click the  button to save the configuration.

Conference

To configure the Conference via Phone Interface

1. Press Menu → Features → Function Keys → Memory keys as Function Keys → Memory key1 (for example)
2. Select the wanted Memory key.
3. Press  and  key to select the Conference in the type field.
4. Press  or Save soft key to save the configuration

To configure Conference via Web Interface

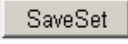

1. Click Function keys → Memory Key.
2. Select the desired Key and select Conference in the Type.
3. Click the  button to save the configuration.

Forward

If the key is configured as Forward key, press this key under the idle status, the IP phone will turn to the Always Forward interface and you can set the Forward to number, then when there is any call to the number will be forwarded to the set number automatically.

To configure the Forward via Phone Interface

1. Press Menu → Features → Function Keys → Memory keys as Function Keys → Memory key1 (for example)
2. Select the wanted Memory key.

3. Press  and  key to select the Forward in the type field.
4. Enter the Number that to forward.
5. Press  or Save soft key to save the configuration



To configure Forward via Web Interface

1. Click Function keys →Memory Key.
2. Select the desired Key and select Forward in the Type.
3. Enter the Value with the number you want to forward
4. Click the  button to save the configuration.

Transfer

You are able to configure the key as a transfer key to perform the Blind/Attended Transfer.

To configure the Transfer via Phone Interface

1. Press Menu →Features →Function Keys→Memory keys as Function Keys → Memory key1(for example)
2. Select the wanted Memory key.
3. Press  and  key to select the Transfer in the type field.
4. Enter the Number that transfer to
5. Press  or Save soft key to save the configuration



To configure Transfer via Web Interface

1. Click Function keys →Memory Key.
2. Select the desired Key and select Transfer in the Type.
3. Enter the Value with the number that wanted transfer to
4. Click the  button to save the configuration.

Hold

The key can be configured as a hold key. You can use this key to hold and resume a call during the conversation.

To configure the Hold via Phone Interface

1. Press Menu →Features →Function Keys→Memory keys as Function Keys → Memory key1(for example)
2. Select the wanted Memory key.
4. Press  and  key to select the Hold in the type field.
5. Press  or Save soft key to save the configuration

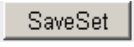

To configure Hold via Web Interface

1. Click Function keys →Memory Key.
2. Select the desired Key and select Hold in the Type.
3. Click the  button to save the configuration.

Group Listening

With this feature, when you active a call, you can listen using Handset and Free-speaker, but only can use the handset to speak.

To configure the Group listening via Phone Interface

1. Press Menu →Features →Function Keys→Memory keys as Function Keys → Memory key1(for example)
2. Select the wanted Memory key.
3. Press  and  key to select the group listening in the type field.
4. Press  or Save soft key to save the configuration

To configure Group listening via Web Interface



1. Click Function keys →Memory Key.
2. Select the desired Key and select Group listening in the Type.
3. Click the  button to save the configuration.

DND

If the key is configured as DND key, you are allowed to active the DND function immediately when you press it and the phone is to reject all incoming calls automatically. Press it again to deactivate DND mode.

To configure the DND via Phone Interface

1. Press Menu →Features →Function Keys→Memory keys as Function Keys → Memory key1(for example)
2. Select the wanted Memory key.

3. Press  and  key to select the DND in the type field.
4. Press  or Save soft key to save the configuration

To configure DND via Web Interface

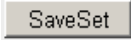
1. Click Function keys → Memory Key.
2. Select the desired Key and select DND in the Type.
3. Click the  button to save the configuration.

To enable DND feature

Press the DND soft key when the phone is idle status, and then DND icon shown on the LCD.

To disable DND feature

Press the DND soft key again, and then there is no DND icon on the LCD.

Redial

If the key is configured as Redial key, you can redial the last placed call from the IP Phone.

To configure Redial via Web Interface

1. Click Function keys → Line key/Memory key
2. Select the desired Key and select redial in the Type.
3. Enter the Label displayed on LCD.
4. Click the  button to save the configuration.

SMS

Send SMS

To send SMS via web Interface

1. Click Setting→SMS
2. Select the account(from which account the SMS sent)
3. Enter the target number
4. Input the content of SMS, and click Send.

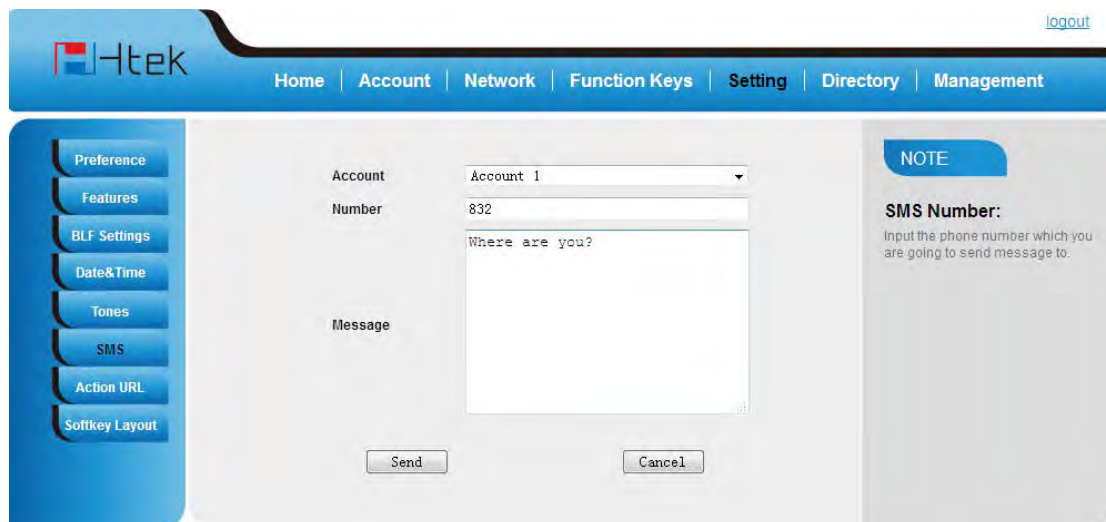



The screenshot shows the Htek web interface for sending SMS. The top navigation bar includes 'Home', 'Account', 'Network', 'Function Keys', 'Setting', 'Directory', and 'Management'. A sidebar on the left lists various settings: Preference, Features, BLF Settings, Date&Time, Tones, SMS, Action URL, and Softkey Layout. The main content area has a form with the following fields: 'Account' (a dropdown menu set to 'Account 1'), 'Number' (a text input field containing '832'), and 'Message' (a large text area containing 'Where are you?'). Below the form are 'Send' and 'Cancel' buttons. On the right side, there is a 'NOTE' box with the text: 'SMS Number: Input the phone number which you are going to send message to.' A 'logout' link is visible in the top right corner.

To send SMS via phone interface:

1. Click Menu→Message→Text Message→Set SMS
2. Enter the contents in the white field.
3. Press the save button
4. Select the account (from which account the SMS sent)
5. Enter the target number (to which account the number sent)
6. Press the Send button.

Set SMS Memory Key

To configure the SMS via Phone Interface

1. Press Menu → Features → Function Keys → Memory keys as Function Keys → Memory key1 (for example)
2. Select the wanted Memory key.
3. Press  and  key to select the SMS in the type field.
4. Press  or Save soft key to save the configuration



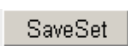

To configure SMS via Web Interface

1. Click Function keys → Memory Key.
2. Select the desired Key and select SMS in the Type.
3. Click the  to save the configuration.

Record

With record feature, you can record calls by pressing a record key on the phone.

To configure the record via phone interface

1. Press Menu → Features → Function Keys → Line or Memory keys as Function Keys → Memory key1 (for example)
2. Select the wanted Line or Memory key.
3. Press  and  or press info soft key to select the Key Event in the type field.
4. Press  and  or press info soft key to select the Record.
5. Press  or Save soft key to save the configuration

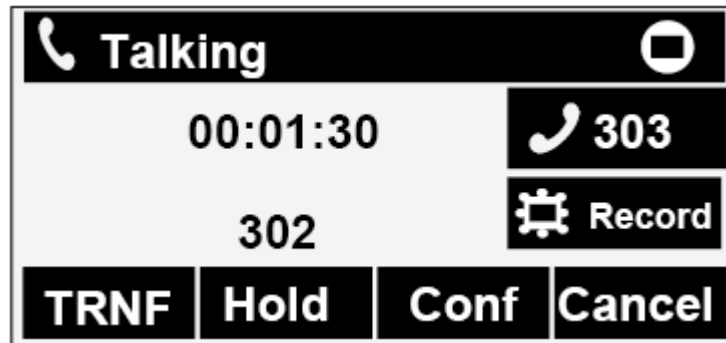

To configure the record via Web Interface

1. Click Function keys → Line or Memory key.
2. Select the desired Line or Memory key and select Record in the Type.
3. Click the  button to save the configuration.



Note:

Please contact the system administrator whether support this feature or not.

URL Record

The phone sends HTTP URL request to trigger a recording. Contact your system administrator for the predefined URL.

To configure the URL record via phone interface

1. Press Menu → Features → Function Keys → Memory keys as Function Keys → Memory key1 (for example)
2. Select the wanted Line or Memory key.
3. Press  and  key to select the URL Record.
4. Press  or Save soft key to save the configuration





To configure the record via Web Interface

1. Click Function keys → Memory key.
2. Select the desired Line or Memory key and select URL Record in the Type.
3. Click the  button to save the configuration.

Paging

With this feature, you can call a paging group directly.

To configure the paging via phone interface

1. Press Menu → Features → Function Keys → Line or Memory keys as Function Keys → Memory key1 (for example)
2. Select the wanted Line or Memory key.
3. Press  and  or press info soft key to select the Key Event in the type field.
4. Press  and  or press info soft key to select the Paging.
5. Press  or Save soft key to save the configuration

To configure the Paging via Web interface

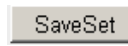



1. Click Function keys → Line or Memory key.
2. Select the desired Line or Memory key and select Paging in the Type.
3. Click the  button to save the configuration.

Shared Line

This feature allows subscribers to share SIP lines. Moreover it also provides status monitoring of

the shared line.

To configure the line key as shared line via phone interface

1. Press Menu → Features → Function Keys → Line or Memory keys as Function Keys → Memory key1 (for example)
2. Select the wanted Line or Memory key.
3. Press  and  key to select the Shared Line in the type field.
4. Press  and  key to select the Account ID.
5. Enter the Label
6. Enter the Value
7. Press  or Save soft key to save the configuration

To configure the line key as shared line via Web Interface

1. Click Function keys → Line or Memory key.
2. Select the desired Line or Memory key and select Shared Line in the Type.
3. Enter the Value.
4. Enter the Label.
5. Select the Account ID
6. Click the  button to save the configuration and then restart.



Note:

This feature is not available on all servers. For more information, contact your system administrator.

Public Hold

The key can be configured as a public hold key. During a conversation, all members belonging to that particular SLA group can use this key to hold or resume a call.

To configure the Public hold via phone interface

1. Press Menu → Features → Function Keys → Line or Memory keys as Function Keys → Memory key1 (for example)
2. Select the wanted Line or Memory key.
3. Press  and  key to select the Public Hold.
4. Press  or Save soft key to save the configuration

To configure public hold via Web Interface

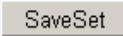

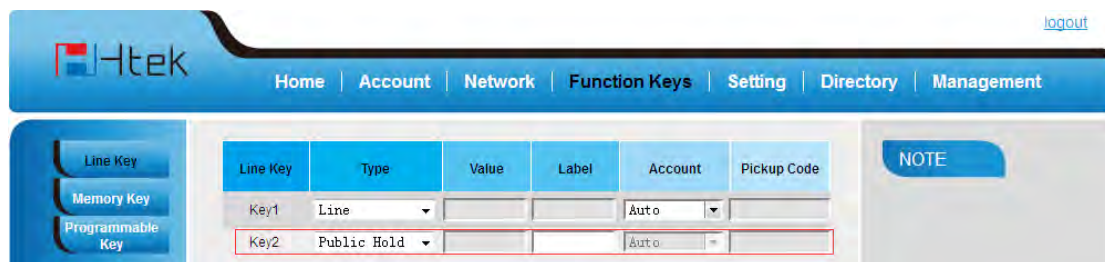
1. Click Function keys → Memory Key.
2. Select the desired Key and select public hold in the Type.
3. Click the  button to save the configuration.



Private Hold

The key can be configured as a private hold key. During a conversation, all members belonging to that particular SLA group can use this key to hold the call, but only the initiator can resume the call.

To configure the Private hold via phone interface

1. Press Menu → Features → Function Keys → Line or Memory keys as Function Keys → Memory key1 (for example)
2. Select the wanted Line or Memory key.
3. Press  and  key to select the Private Hold.
4. Press  or Save soft key to save the configuration

To configure private hold via Web Interface

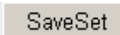

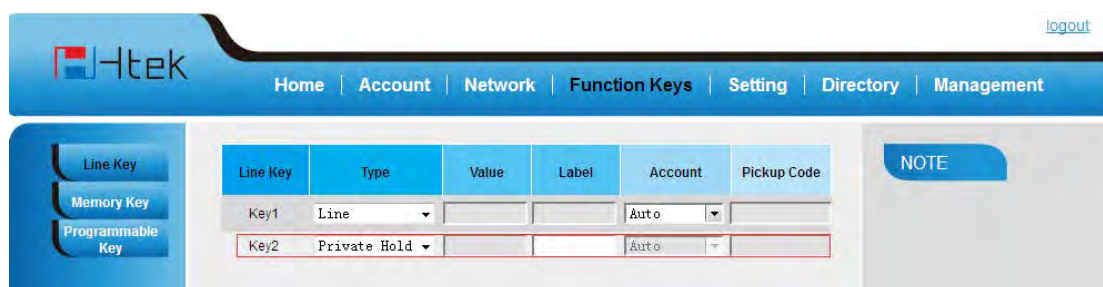

1. Click Function keys → Memory Key.
2. Select the desired Key and select Private hold in the Type.
3. Click the  button to save the configuration.



Share line

Shared line is configured by assigning the same extension number to multiple lines. You can use the shared line feature to share an extension number which is used on two or more IP phones at the same time. An incoming call to that number will cause all phones to ring simultaneously. The incoming call can be answered on one of the phones but not all of them. This feature is very useful in the boss and secretary scenario. For example, the secretary can share the boss' extension number on her phone. When there is an incoming call to the extension number of the boss, both the phones of the boss and the secretary will ring simultaneously. Either the boss or the secretary can answer the call. Calls on shared line can be placed on hold or barged in.

To configure the share line via phone interface

1. Press Menu → Features → Function Keys → Line or Memory keys as Function Keys → Memory key1 (for example)
2. Select the wanted Line or Memory key.
3. Press  and  or press  key to select the share line.
4. Enter the number in the value field.
5. Select the desired account in the Account field.
6. Press  or Save soft key to save the configuration

To configure the share line feature via web interface:

1. Click Function keys → Memory Key.
2. Select the desired Key and select share line in the Type.
3. Enter the number in the value field.
4. Select the desired account from the pull-down list of Account field.
5. Click the  button to save the configuration.

Note:

This feature is not available on all servers. For more information, contact your system administrator.





Hot Desking

Hot Desking originates from the definition of being the temporary physical occupant of a work station or surface by a particular employee. A primary motivation for Hot Desking is cost reduction. This feature is regularly used in places where not all the employees are in the office at the same time, or not in the office for very long at all, which means actual personal offices would be often vacant, consuming valuable space and resources.

You can use Hot Desking on the IP phone to logout the existing accounts and then log in a new account, that is, many users can share the phone resource in different time. To use this feature, you need to configure a Hot Desking key in advance.

This feature is supported on the version 1.0.3.82 or later

To configure the hot desking via phone interface

1. Press Menu →Features →Function Keys→Line or Memory keys as Function Keys → Memory key1(for example)
2. Select the wanted Line or Memory key.
3. Press  and  or press  key to select the hot desking.
4. Enter the display name in the value field.
5. Press  or Save soft key to save the configuration

To configure the hot desking via web interface:

1. Click Function keys →Memory Key.
2. Select the desired Key and select hot desking in the Type.
3. Enter the number in the value field.
4. Select the desired account from the pull-down list of Account field.
5. Click the  button to save the configuration.

To use the Hot desking feature on the user interface:

1. Press the Hot desking key when the IP Phone is idle.
2. Enter the Extension number and password



3. Click Save softkey

You can see the account information which has changed.





Note:

This feature is not available on all servers. For more information, contact your system administrator.

ACD (Pending)

ACD feature is often used in offices for customer service, such as call center. The ACD system handles large volumes of incoming calls from callers who have no need to talk to a specific person but who require assistance from any of multiple persons at the earliest opportunity. The ACD feature on the Htek IP Phone allows the ACD system to distribute calls from large volumes of incoming calls to the registered IP phone users. To use this feature, you should configure an ACD key in advance.

To configure the ACD via phone interface

1. Press Menu → Features → Function Keys → Line or Memory keys as Function Keys → Memory key1 (for example)
2. Select the wanted Line or Memory key.
3. Press  and  or press  key to select the ACD.
4. Enter the label in the label field.
5. Select the desired account in the Account field.
6. Press  or Save soft key to save the configuration

To configure the ACD via web interface:

1. Click Function keys → Memory Key.
2. Select the desired Key and select ACD in the Type.
3. Enter the label in the label field.
4. Select the desired account from the pull-down list of Account field.
5. Click the  button to save the configuration.





Note:

This feature is not available on all servers. For more information, contact your system administrator.

Zero Touch

You can use this key feature to configure auto provision and network parameters quickly.
This feature is supported on the version 1.0.3.82 or later

To configure the zero touch via phone interface

1. Press Menu → Features → Function Keys → Line or Memory keys as Function Keys → Memory key1 (for example)
2. Select the wanted Line or Memory key.
3. Press  and  or press  key to select the zero touch
4. Press  or Save soft key to save the configuration

To configure the zero touch via web interface:

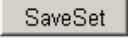
1. Click Function keys → Memory Key.
2. Select the desired Key and select zero touch in the Type.
3. Click the  button to save the configuration.

To use the zero touch feature on the user interface:

1. Press the zero touch key when the IP Phone is idle.
2. The IP Phone will enter the WAN Port interface, you can change the WAN Type by pressing the Navigation keys.
3. Press the Next softkey to enter Network interface, then you can configure some information.
4. Press the Next softkey again, you can configure auto provision information.
5. When you finish the setting, you can press the OK to accept the changes.

Note:

This feature is not available on all servers. For more information, contact your system administrator.

Upgrade

Factory Reset

To set Factory Reset by phone interface

1. Press Menu → Setting → Advanced Setting(default password: admin)→ Factory Reset
2. Press OK soft key in the warning page.

To reset to Factory via web interface

1. Click Management → Upgrade
2. Click  and then confirm the setting.



The screenshot shows the Htek web interface. The top navigation bar includes Home, Account, Network, Function Keys, Setting, Directory, and Management. The left sidebar contains Password, Upgrade, Auto Provision, Configuration, Trusted CA, Server CA, Tools, Restart, and Reboot. The main content area displays the 'Upgrade' section with the following information:

● Image Version	
Major Version	IMG-1.0.3.74(2014-12-27 11:40:00)
Minor Version	IMG-1.0.3.75(2015-01-13 10:44:00)
● Reset To Factory	<input type="button" value="Reset To Factory"/>
● ROM Firmware Upgrade	<input type="button" value="浏览... 未选择文件。"/> <input type="button" value="Upgrade"/>

A red box highlights the 'Reset To Factory' button and its label. On the right side, there is a 'NOTE' section with the following text:

NOTE

Image Version:
Show the information of the two system image version.

Reset To Factory :
Reset all the settings of the phone to default configurations.

Restart:
one simple operation for restart the voip application.

Pcap Feature

To use pcap via web interface:

1. Click Management→Tools
2. Click Start and then operation the phone
3. When finish the operation, click stop and then click Export.
4. Then you'll get the Pacp captures.

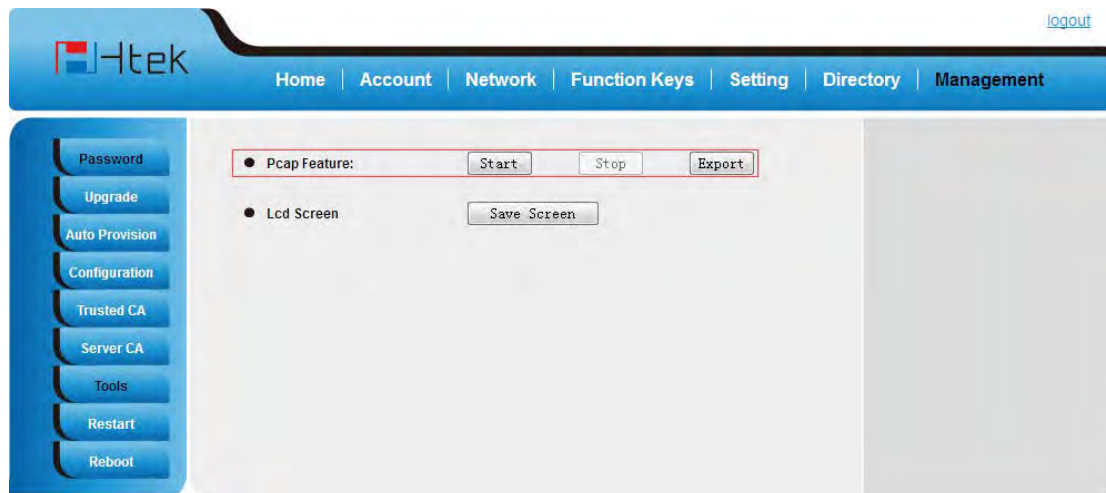

System Log

To download system log via web interface:

1. Click Management→Configuration
2. Click  of the system Log
3. Then you'll get a txt file: syslog.txt.

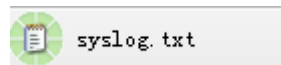

● System Log

Download System Log

Syslog Server

Syslog Level

Upgrade

To upgrade via HTTP, the “Management”->“auto provision” ->” Firmware Upgrade”-> “Upgrade Mode” field needs to be set to HTTP, respectively. “Firmware Server Path” needs to be set to a valid URL of a HTTP server, server name can be in either FQDN or IP address format. Here are examples of some valid URL.

e.g. firmware.mycompany.com:5688/ Hanlong

e.g. www.mycompany.com:5688/fm/ Hanlong

e.g. 218.2.83.110

Instructions for firmware upgrade via HTTP:

- (1) End users can choose to download the free HTTP server from <http://httpd.apache.org/> or use Microsoft IIS web server. Then setup HTTP server.
- (2) Unzip the firmware file and put all of them under the *root/fm* directory of the HTTP server.
- (3) Visiting “HTTP:\\192.168.0.254\fm\fw8xx.rom on localhost by browser” to verify the HTTP Server. If visiting “HTTP: \\192.168.0.254\fm\fw8xx.rom on other computer is no prompt to download fw8xx.rom file, please check the firewall (Suggest close the firewall).

To configure the server path via web interface:

1. Click Management→Auto provision:
2. Select the upgrade mode in the upgrade mode field
3. Enter the Firmware server path and config server path (192.168.0.254 is HTTP server).
4. Enter the HTTP server’s username and password (optional).
5. Click the button to save the configuration.
6. Restart the UC8xx, IP Phone will restart and auto-get firmware files from HTTP server.

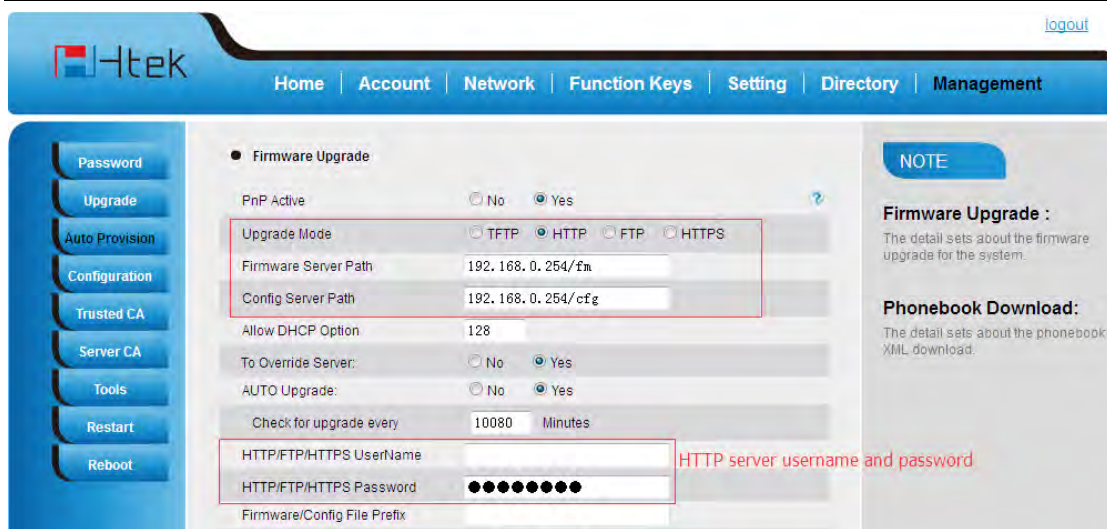

NOTES:

- Hanlong recommends end-user use the Hanlong HTTP server. For large companies, we recommend to maintain their own TFTP/HTTP/FTP/HTTPS server for upgrade and provisioning procedures.
- Once a “Firmware Server Path” is set, user needs to update the settings and restart the IP Phone. If the configured firmware server is found and a new code image is available, the UC8xx will attempt to retrieve the new image files by downloading them into the UC8xx’s SDRAM. During this stage, the UC8xx’s LEDs will blink fastly until the checking/downloading process is completed. Upon verification of checksum, the new code image will then be saved into the Flash. If TFTP/HTTP/FTP/HTTPS fails for any reason (e.g. TFTP/HTTP/FTP/HTTPS server is not responding, there are no code image files available for upgrade, or checksum test fails, etc), the UC8xx will stop the TFTP/HTTP/FTP/HTTPS process and simply boot using the existing code image in the flash.
- Firmware upgrade may take as long as 3 to 8 minutes over Internet, or just 1 minutes if it is performed on a LAN. It is recommended to conduct firmware upgrade in a controlled LAN environment if possible. For users who do not have a local firmware upgrade server.
- Hanlong’s latest firmware is available at <http://www.h-tek.com> →Support→Firmware Download.
- Oversea users are strongly recommended to download the binary files and upgrade firmware locally in a controlled LAN environment.

To upgrade manually via the Web configuration interface

1. Click Management → Upgrade
2. Click Brower or the blank.

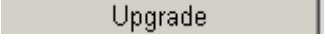
3. Select the firmware (fw8xx.rom)and then click .

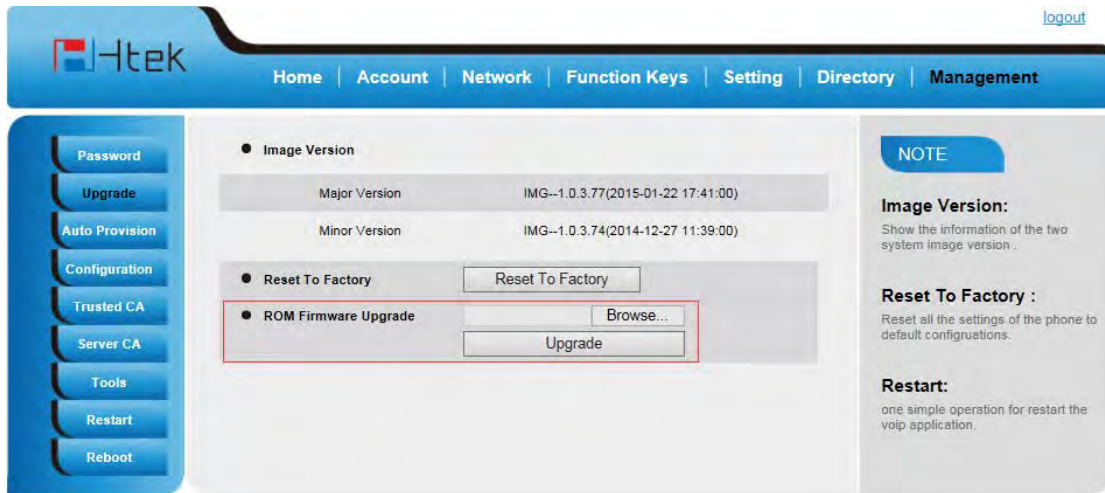

Configuration File

To download configuration file:

1. Click Management → Configuration →Download Device Configuration
2. Then you can get a file: cfg.bin or cfg.xml

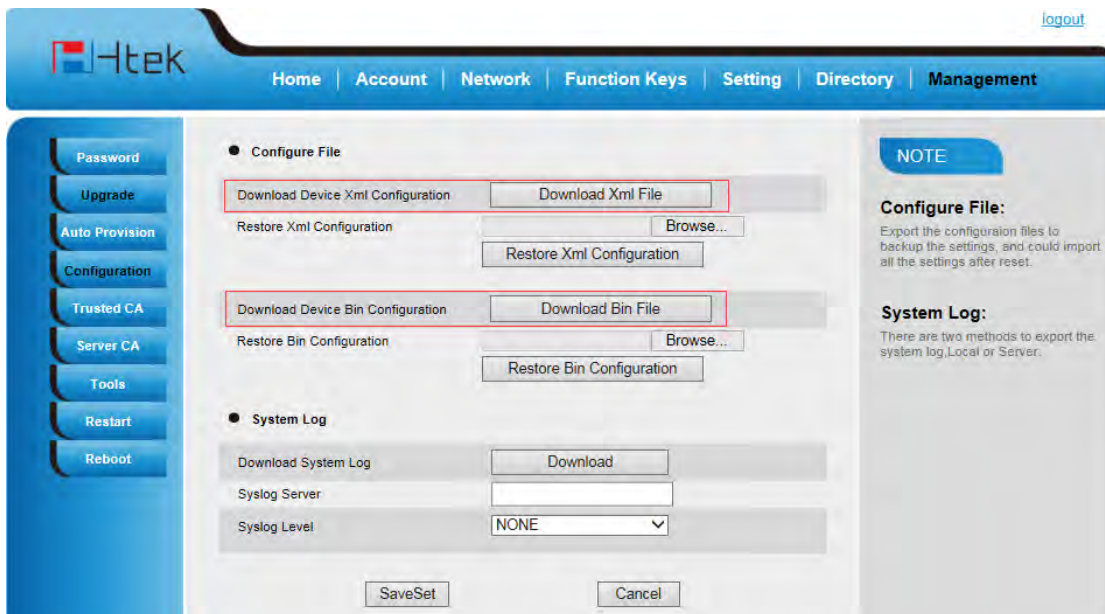

To Restore a configuration file:

1. Click Management → Configuration → Restore configuration
2. Select the xxx.bin or xxx.xml file, and then Click the **Restore Bin Configuration**, then IP Phone will reboot.

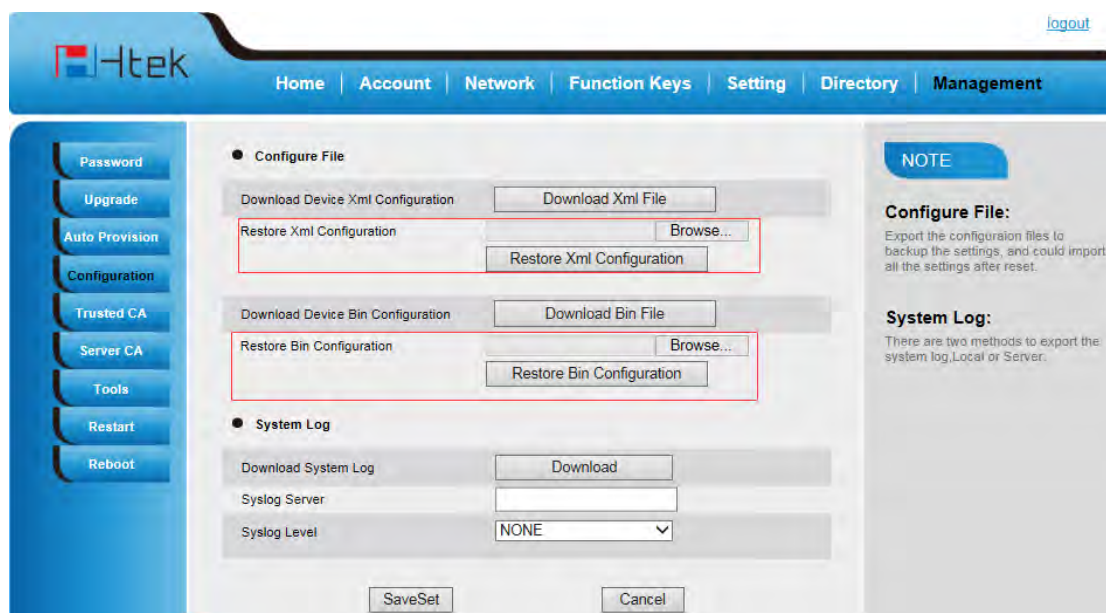

Troubleshooting

Why is the phone LCD screen blank?

1. Ensure your phone is properly plugged into a functional AC outlet.
2. Ensure that the phone isn't plugged into a plug controlled by a switch that is off.
3. If the phone is plugged into a power strip, try plugging it directly into a wall outlet instead.
4. If your phone is powered from PoE, ensure you use a PoE compliant switch or hub, or contact your system administrator for more information.
5. Check that the power LED is on to ensure the phone is powered on.

Why does the phone display "Network Unavailable"?

- Ensure that the Ethernet cable is plugged into the Internet port on the phone and the Ethernet cable is not loose.
- Ensure that the switch or hub in your network is operational.
- Contact your system administrator for more information.

Why can't I get a dial tone?

- Check for any loose connections and that the phone has been installed properly. For the Installation instructions, refer to [Phone Installation](#).
- Check whether dial tone is present on one of the audio modes.
- Switch between the Handset, Headset (if present) or Hands-Free Speakerphone to check whether dial tone is present for one of the audio modes.
- If the dial tone exists on another audio mode, connect a different handset or headset to isolate the problem.

Where to set the tone?

You can set the tone on web interface:

- Click Setting→Tones
- Define the dial tone, ringing, busy tone...
- For the tones, you can check with your system administrator.
- More Click [Tone Notes](#).

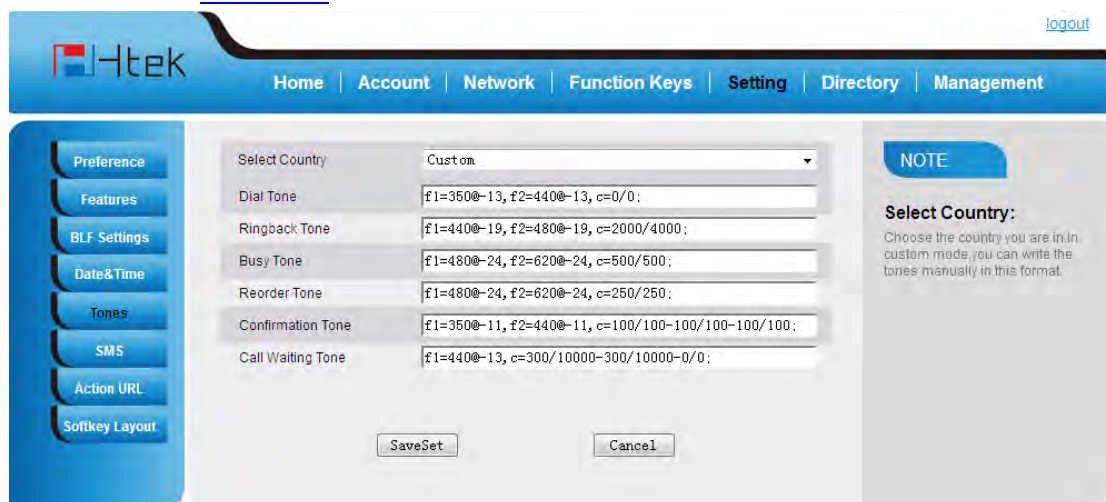

How to download XML Configuration?

- Click Management→Configuration→

How to Import Trusted CA certificate?

- Click Management→Trusted CA

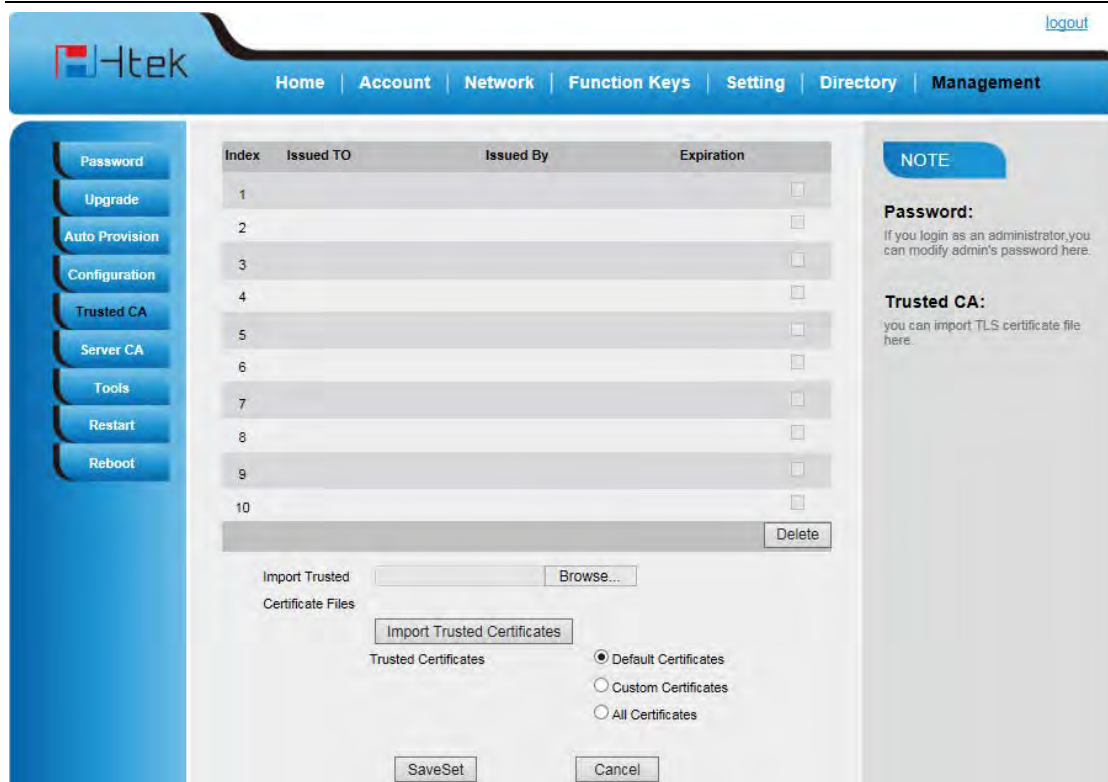

How to Import Server CA certificate?

- Click Management → Server CA

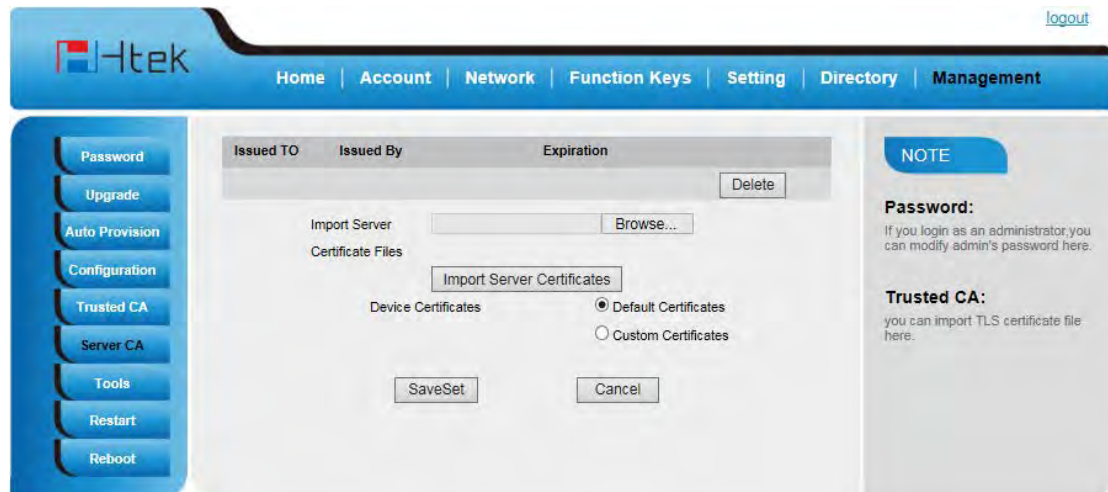

How to use Vlan?

- For Vlan information, please click [VLAN Note](#)

How to use LLDP?

- For LLDP information, please click [VLAN Note](#)
- VLAN Notes including:
 1. Voice VLAN
 2. Major Benefits of Using VLANs
 3. VLAN discovery method on Htek ip phones
 4. LLDP Feature on Htek IP Phones
 5. Supported TLVS of IP Phones
 6. Configuring LLDP Feature
 7. DHCP VLAN
 8. Open the DHCP VLAN on the Htek IP Phones
 9. VLAN under Bridge Mode
 10. VLAN under NAT Mode

How to Set LCD and Web GUI:

- Click [LCD and Web GUI custom Guide](#)

How to Upgrade via FTP?

- Click [How to Upgrade Note](#)

How to make Ringtone?

- Click [How to Make Ringtone](#)

How to use Open VPN?

- Click [Open VPN note](#)

Provisioning Guide on Free PBX:

- Click [Set Auto Provision on FreePBX](#)

Failover Notes

- Click [Failover Note](#)

How to Use Auto Provision Phonebook?

- Click [About AP Phonebook](#)

All Documents

- a) Click [Documents Guide](#), you can get all tech files.