

FCC STATEMENT

This device complies with Part 15 of the FCC Rules. Operation is subject to the following two conditions:

- (1) This device may not cause harmful interference, and
- (2) This device must accept any interference received, including interference that may cause undesired operation.

Note:

This equipment has been tested and found to comply with the limits for Class B digital devices, pursuant to Part 15 of the FCC rules. These limits are designed to provide reasonable protection against harmful interference in a residential installation. This equipment generates uses and can radiate radio frequency energy and, if not installed and used in accordance with the instructions, may cause harmful interference to radio communications. However, there is no guarantee that interference will not occur in a particular installation. If this equipment does cause harmful interference to radio or television reception, which can be determined by turning the equipment off and on, the user is encouraged to try to correct the interference by one or more of the following measures:

- Reorient or relocate the receiving antenna.
- Increase the separation between the equipment and receiver.
- Connect the equipment into an outlet on a circuit different from that to which the receiver is connected.
- Consult the dealer or an experienced radio/TV technician for help.

Use of shielded cable is required to comply with Class B limits in Subpart B of Part 15 of the FCC rules.

Do not make any changes or modifications to the equipment unless otherwise specified in the manual. If such changes or modifications should be made, you could be required to stop operation of the equipment.

READ THIS FIRST

Trademark Information

- Microsoft® and Windows® are U.S. registered trademarks of Microsoft Corporation.
- Pentium® is a registered trademark of Intel Corporation.
- Macintosh® is a trademark of Apple Computer, Inc.
- SD™ is a trademark.
- Photo Explorer and Photo Express are trademarks.
- Other names and products may be trademarks or registered trademarks of their respective owners.

Product Information

- Product design and specifications are subject to change without notice. This includes primary product specifications, software, software drivers, and user's manual. This User Manual is a general reference guide for the product.
- The product and accessories that come with your digital still camera may be different from those described in this manual. This is due to the fact that different retailers often specify slightly different product inclusions and accessories to suit their market requirements, customer demographics, and geographical preferences. Products very often vary between retailers especially with accessories such as batteries, chargers, AC power adapters, memory cards, cables, carrying cases/pouches, and language support. Occasionally a retailer will specify a unique product color, appearance, and internal memory capacity. Contact your dealer for precise product definition and included accessories.
- The illustrations in this manual are for the purpose of explanation and may differ from the actual design of your digital still camera.
- The manufacturer assumes no liability for any errors or discrepancies in this user manual.
- For user manual and driver updates, refer to our website or contact your dealer.

SAFETY INSTRUCTIONS

Read and understand all **Warnings** and **Cautions** before using this product.

Warning

If foreign objects or water have entered the camera, turn the power OFF and remove the batteries and the AC power adapter.

Continued use in this state might cause fire or electric shock. Consult the vendor.



If the camera has fallen or its case has been damaged, turn the power OFF and remove the batteries and the AC power adapter.

Continued use in this state might cause fire or electric shock. Consult the vendor.



Do not disassemble, change or repair the camera.

This might cause fire or electric shock. For repair or internal inspection, ask vendor.



Use the supplied AC power adapter only with the indicated power supply voltage.

Use with any other power supply voltage might cause fire or electric shock.



Do not use the camera in areas near water.

This might cause fire or electric shock. Take special care during rain or snow, on the beach, or near the shore.



Do not place the camera on inclined or unstable surfaces.

This might cause the camera to fall or tilt over, causing injury.



Keep the battery out of the reach of children.

Swallowing the battery might cause poisoning. If the battery is accidentally swallowed, immediately consult a physician.



Do not use the camera while you are walking, driving or riding a vehicle.

This might cause you to fall over or result in traffic accident.



Caution

When inserting the battery, pay careful attention to the polarity (+ or -) of the terminals.

Inserting the battery with its polarities inverted might cause fire and injury, or damage to the surrounding areas due to the battery rupturing or leaking.



Do not fire the flash close to anyone's eyes.

This might cause damage to the person's eyesight.



Do not subject the LCD monitor to impact.

This might damage the glass on the screen or cause the internal fluid to leak. If the internal fluid enters your eyes or comes into contact with your body or clothes, rinse with fresh water. If the internal fluid has entered your eyes, consult a physician to receive treatment.



A camera is a precision instrument. Do not drop it, strike it or use excessive force when handling the camera.

This might cause damage to the camera.



Do not use the camera in humid, steamy, smoky, or dusty places.

This might cause fire or electric shock.



Do not remove the battery immediately after long period of continuous use.

The battery becomes hot during use. Touching a hot battery might cause burns.



Do not wrap the camera or place it in cloth or blankets.

This might cause heat to build up and deform the case, resulting in fire. Use the camera in a well-ventilated place.



Do not leave the camera in places where the temperature may rise significantly, such as inside a car.

This might adversely affect the case or the parts inside, resulting in fire.



Before you move the camera, disconnect cords and cables.

Failure to do this might damage cords and cables, resulting in fire and electric shock.



Notes on Battery Usage

When you use the battery, carefully read and strictly observe the **Safety Instructions** and the notes described below:

- Different battery types and surrounding temperatures may affect the battery performance.
- Avoid using batteries in extremely cold environments as low temperatures can shorten the battery life and reduce camera performance.
- Using the new rechargeable battery or rechargeable battery that has not been used for an extended period of time (the battery that passed the expiry date is an exception) might affect the number of pictures that can be taken. Therefore, to maximize its performance and lifetime, we recommend that you fully charge the battery and discharge it for at least one complete cycle before use.
- The battery may feel warm after long period of continuous use of the camera or the flash. This is normal and not a malfunction.
- The camera may feel warm after long period of continuous use. This is normal and not a malfunction.
- If the battery is not to be used for a long period of time, remove it from the camera to prevent leakage or corrosion.
- If the battery is not to be used for a long period of time, store it after no battery power left. If the battery is stored for a long time in a fully charged state, its performance may be impaired.
- Always keep the battery terminals in a clean state.
- Risk of explosion if battery is replaced by an incorrect type.
- Dispose of used batteries according to the instructions.

CONTENTS

- 8 INTRODUCTION**
 - 8 Overview
 - 9 Package Contents
- 10 GETTING TO KNOW YOUR CAMERA**
 - 10 Front View
 - 11 Rear View
 - 12 LCD Monitor Information
 - 14 LED Indicators
- 15 PREPARING THE CAMERA**
 - 15 Installing the Battery
 - 16 Charging the Battery
 - 17 Using an AC Adapter/Charger
 - 17 Attaching the Camera Strap
 - 18 Inserting and Removing an SD Memory Card
- 19 GETTING STARTED**
 - 19 Turning the Power On/Off
 - 20 Setting the Date and Time
 - 21 Choosing the Screen Language
 - 22 Formatting an SD Memory Card or Internal Memory
 - 23 Setting Image Resolution and Quality
- 25 CAMERA MODE**
 - 25 Capturing Images
 - 26 Setting the Scene Mode
 - 28 Using the Optical Zoom
 - 29 Using the Digital Zoom
 - 30 Using the Flash
 - 32 Using the Self-Timer
 - 33 Adjusting the Exposure
 - 34 Setting the White Balance
- 35 ADVANCED CAPTURE**
 - 35 Continuous Capture
 - 36 Auto-Exposure Bracketing (AEB)
 - 37 Adjusting White Balance Manually
- 38 PLAYBACK MODE - THE BASICS**
 - 38 Viewing Images
 - 39 Magnifying Images
 - 40 Thumbnail Display (Index Playback)
 - 41 Slideshow Display
 - 41 Resizing an Image

- 42 MOVIE MODE**
 - 42 Recording Video Clips
 - 43 Playing Back Video Clips
- 44 PLAYBACK MODE - ADVANCED FUNCTIONS**
 - 44 Playing Back Images/Video Clips on TV
 - 45 Deleting Images/Video Clips
 - 46 Protecting Images/Video Clips
 - 47 Setting the DPOF
 - 49 Changing the Camera Startup Screen
- 50 AUDIO MODE**
 - 50 Recording Voice Files
 - 50 Playing Back a Voice File
 - 51 Deleting a Voice File
- 52 TRANSFERRING FILES FROM YOUR DIGITAL STILL CAMERA TO COMPUTER**
 - 53 Step 1: Installing the USB driver
 - 54 Step 2: Connecting the digital still camera to your computer
 - 55 Step 3: Downloading images, videos or voice files
- 56 CONNECTING TO A PICTBRIDGE COMPLIANT PRINTER**
- 59 USING THE DIGITAL STILL CAMERA AS A PC CAMERA**
 - 59 Step 1: Installing the PC camera driver
 - 60 Step 2: Connecting the digital still camera to your computer
 - 60 Step 3: Running your application software (i.e. Windows NetMeeting)
- 61 EDITING SOFTWARE INSTALLATION**
 - 61 Installing Photo Explorer
 - 62 Installing Photo Express
- 63 MENU OPTIONS**
 - 63 Camera Menu
 - 66 Movie Menu
 - 67 Play Menu
 - 69 Setup Menu (In Camera and Movie Modes)
 - 70 Setup Menu (In Playback Mode)
- 71 CONNECTING YOUR CAMERA TO OTHER DEVICES**
- 72 SPECIFICATIONS**
- 73 TROUBLESHOOTING**

INTRODUCTION

Overview

Congratulations on your purchase of a new digital still camera.

Capturing high-quality digital images is fast and easy with this state-of-the-art smart camera. Equipped with a 5.2 megapixel CCD, this camera is capable of capturing images with a resolution of up to 2560 x 1920 pixels.

Other features provided by the camera include:

- **2.5" LTPS color LCD monitor**
The LCD monitor makes it easy to frame your subject when capturing images. It also displays the images you have captured.
- **Optical zoom**
The 3x optical zoom lens allows you to capture telephoto and wide-angle images.
- **Digital zoom**
4x digital zoom in conjunction with the 3x optical zoom permit zoom photography of up to 12 times magnification. Captured images may be reviewed and a selected portion of an image may be enlarged up to 8x.
- **Automatic flash**
An auto-flash sensor automatically detects the shooting (lighting) conditions and determines whether the flash should be used.
- **9MB internal (built-in) memory**
You may capture and store images without the immediate need for an additional memory card.
- **SD memory card support**
You may wish to expand the memory capacity (up to 512MB) with a Secure Digital (SD) memory card.
- **Camcorder, PC Camera, and voice-recorder support**
- **USB connection (USB 2.0 compliant)**
Still images, video clips, or voice files that you have recorded can be downloaded to your computer using the USB cable (A USB driver is required for Windows® 98).
- **DPOF support**
You can print your images on a DPOF compatible printer by simply inserting the memory card with embedded printing information.
- **PictBridge support**
You can connect the camera directly to a PictBridge compatible printer and perform image selection and printing using the camera monitor screen and controls.

Package Contents

Carefully unpack the box and ensure that you have the following items. In the event that any item is missing or if you find any mismatch or damage, promptly contact your dealer.

Common Product Components:



- 1 x Traveler Slimline X5 Digital Still Camera
- 1 x Traveler 256MB SD Memory Card
- 1 x Traveler Conversion Adapter
- 1 x Traveler AC Adapter/Charger
- 2 x Traveler Rechargeable Lithium-ion Batteries
- 1 x Traveler Camera Pouch
- 1 x Software CD-ROM
- 1 x USB Cable
- 1 x AV Cable
- 1 x Camera Strap
- 1 x User's Manual
- 1 x Traveler docking station

GETTING TO KNOW YOUR CAMERA

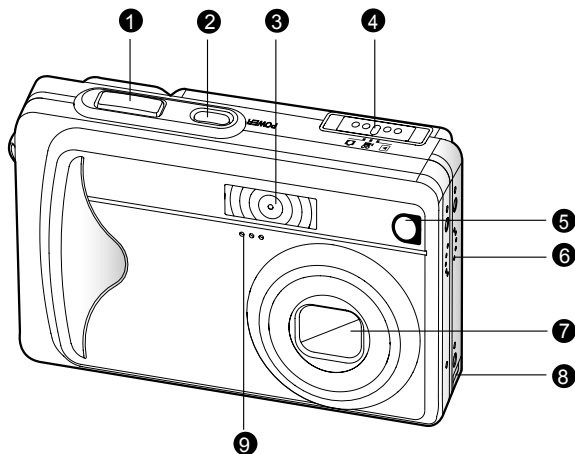
Front View



- 1. Shutter button
- 2. **POWER** Power button
- 3. Flash
- 4. Mode switch

-  Camera mode
-  Movie mode
-  Playback mode

- 5. Self-timer LED (AF auxiliary light)
- 6. Speaker
- 7. Lens
- 8. Conversion adapter terminal
- 9. Microphone

Rear View

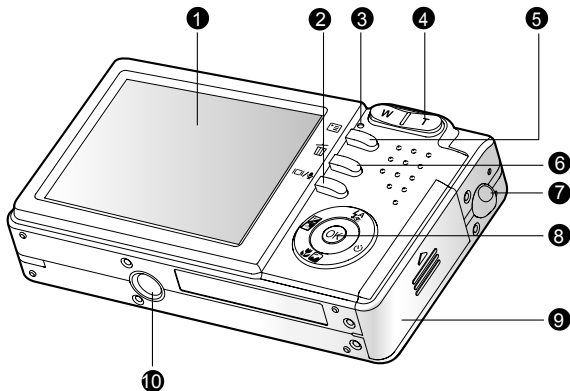

- | | |
|---|---------------------------------|
| 1. LCD monitor | 5. Menu button |
| 2. Display button/
Audio mode button | 6. Delete button |
| 3. Status LED | 7. Strap eyelet |
| 4. T Zoom in (Telephoto) button
W Zoom out (Wide-angle) button | 8. Control buttons |
| | 9. Battery/SD memory card cover |
| | 10. Tripod socket |

Control Buttons

- | |
|---|
| 1. Flash button |
| ▲ Up button |
| 2. Exposure compensation/
Backlight correction button |
| ◀ Left button |
| 3. Scene mode button |
| ▼ Down button |
| 4. Self-timer button |
| ▶ Right button |
| 5. OK Set button |

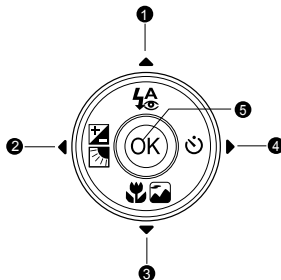

LCD Monitor Information

■ Camera Mode

- Camera mode
- Image quality
 - [**] SUPER FINE
 - [*] FINE
 - [★] NORMAL
- Image size (resolution)
 - [SM] 2560 x 1920
 - [SM] 2048 x 1536
 - [M] 1280 x 960
 - [M] 640 x 480
 - [M] TIFF IMAGE
- Available number of shots
- SD memory card indicator (if present)
- [B] Adapter indicator/
Battery power indicator
 - [Full] Full battery power
 - [Med] Medium battery power
 - [Low] Low battery power
 - [Virt] Virtually no battery power
- Scene mode
 - [Auto] AUTO
 - [Portrait] PORTRAIT
 - [Landscape] LANDSCAPE
 - [Night] NIGHT SCENE
 - [Sports] SPORTS
 - [Macro] MACRO
- Flash mode
 - [Red Eye] RED EYE
 - [No Flash] NO FLASH
 - [Auto Flash] AUTO FLASH
 - [Forced Flash] FORCED FLASH
- Self-timer icon (if used)
 - [3s] 3-second delay
 - [10s] 10-second delay
- White balance
 - [Auto] AUTO
 - [Daylight] DAYLIGHT
 - [Cloudy] CLOUDY
 - [Sunset] SUNSET
 - [Tungsten] TUNGSTEN
 - [Fluorescent] FLUORESCENT
- Capture mode icon
 - [Single] SINGLE
 - [Continuous] CONTINUOUS
 - [AEB] AEB
- Time
- Date
- Focus area
- [+0.7EV] Exposure compensation
- [Backlight] Backlight correction
- Zoom status

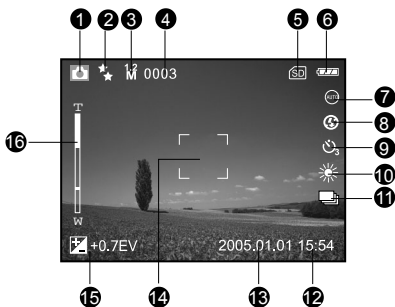

■ Movie Mode

1. Movie mode
2. Available recording time/Elapsed time
3. Video size
[VGA] 640 x 480
[QVGA] 320 x 240
4. SD memory card indicator (if present)
5. Battery power indicator
6. Time
7. Date
8. Exposure compensation (no indication with 0EV)
9. Zoom status

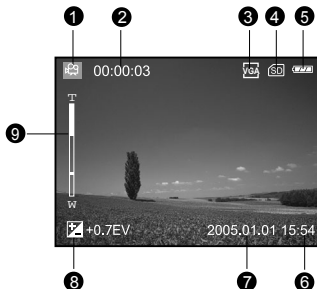

■ Playback mode -Image Playback

1. Playback mode
2. Frame number
3. SD memory card indicator (if present)
4. Battery power indicator
5. Image size (resolution)
6. Camera mode

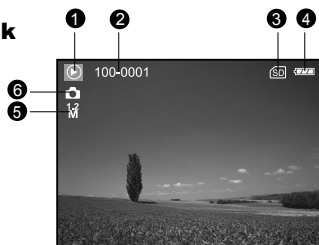

■ Playback mode -Video Playback

1. Playback mode
2. Frame number
3. Video size
4. SD memory card indicator (if present)
5. Battery power indicator
6. Stop indicator
7. Fast reverse playback indicator
8. Fast forward playback indicator
9. Video status bar
10. Movie mode

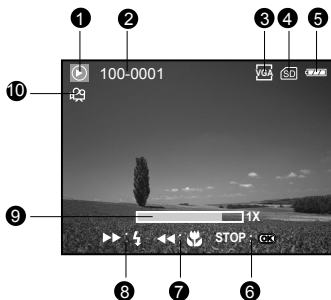

■ Audio Mode

1. Audio mode
2. SD memory card indicator (if present)
3. Battery power indicator
4. Sound level (speaker volume)
5. Audio file name

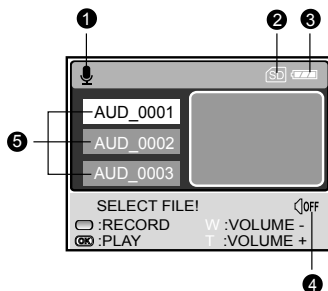

LED Indicators

Indicator	Status	Description/Activity
Status LED	Solid red	1.The digital still camera is powering up. 2.The digital still camera is in the process of battery charge.
	Blinking red	Image is being processed and stored to memory.
	Solid green	USB communication is in progress.
Self-timer LED	Blinking red	The self-timer function is activated.

PREPARING THE CAMERA

Installing the Battery

We highly recommend that you use the specified rechargeable lithium-ion battery to realize the full capability of your digital still camera. Make sure that the power of the digital still camera is off before inserting or removing the battery.

1. Open the battery/SD memory card cover.
2. Insert the battery in the correct orientation shown.
 - Tilt the battery lock lever in the direction of the arrow and orient the battery so that its label is facing to the rear side of the camera, and then insert the battery.
3. Close the battery/SD memory card cover.

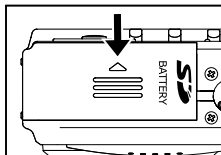
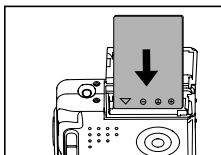
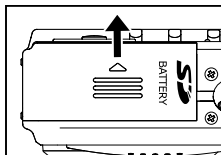

To remove the battery

Open the battery/SD memory card cover and then release the battery lock lever. When the battery has come out a little, slowly pull it out the rest of the way.

Charging the Battery

The state-of-charge of the battery will affect the performance of the digital still camera. To maximize battery performance and lifetime, it is recommended that you fully charge the battery using the AC adapter/charger and then fully discharge it (through normal use) at least one time. Make sure that the power of the digital still camera is off and then insert the battery before starting.

1. Insert the conversion adapter into the conversion adapter terminal of the camera as shown in the illustration.

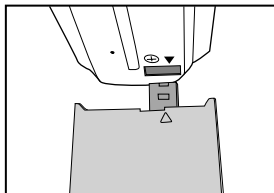

2. Connect one end of the AC adapter/charger to the DC IN terminal of the conversion adapter.
3. Connect the other end of the AC adapter/charger to a wall outlet.
 - Charging time differs depending on the ambient temperature and the status of battery.

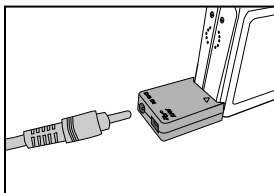

NOTE

- The digital still camera must be used with the specified AC adapter/charger. Damage caused by the use of an incorrect adapter is not covered under the warranty.
- Always make sure that the digital still camera is off before removing the battery.
- The battery may feel warm after it has been charged or immediately after being used. This is normal and not a malfunction.
- When using the digital still camera in cold environments, keep the digital still camera and its battery warm by holding it inside your jacket or other warm protective environment.

Using an AC Adapter/Charger

Using an AC adapter/charger prevents the digital still camera from automatically powering off while transferring files to your computer.

Perform the steps in the preceding section "Charging the Battery".



NOTE

- Make sure to use only the AC adapter/charger specified for the camera. Damage caused by the use of an incorrect adapter is not covered under the warranty.

Attaching the Camera Strap

Attach the strap as shown in the illustration.

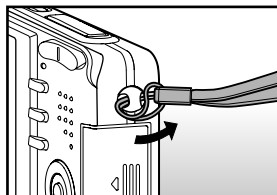
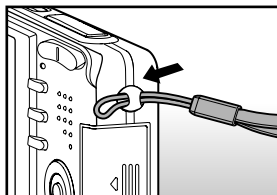

Inserting and Removing an SD Memory Card

You can also expand the memory capacity by using an optional SD (Secure Digital) memory card so that you can store more files.

1. Always make sure the digital still camera is turned off before inserting or removing a memory card.
2. Insert an SD memory card in the correct orientation as shown in the illustration.
3. Close the battery/SD memory card cover.
 - To remove the SD memory card, make sure the camera is turned off. Press lightly on the edge of the memory card and it will eject.

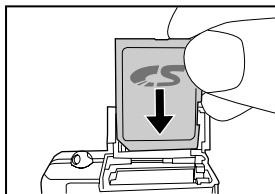

NOTE

- Be sure to format an SD memory card with this digital still camera before using it. Refer to section in the manual titled “**Formatting an SD Memory Card or Internal Memory**” for further details.
- To prevent valuable data from being accidentally erased from an SD card, you can slide the write-protect tab (on the side of the SD memory card) to “LOCK”.
- To save, edit, or erase data on an SD memory card, you must unlock the card.

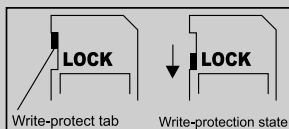

GETTING STARTED

Turning the Power On/Off

- Press the **POWER** button to turn on your digital still camera.
- To turn off your digital still camera, press the **POWER** button again.

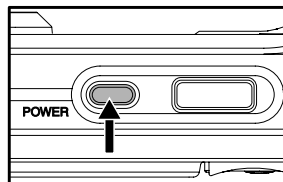

NOTE

- If the camera goes unused for a certain period of time while the camera is powered on, the camera will switch to an idle mode, and eventually turn itself off to conserve power.
- The power is turned off automatically when the camera has not been operated for a certain period time. To resume operation, turn the power on again. Refer to section in this manual titled "POWER OFF" in the Setup Menu (In Camera and Movie Modes) for further details.

Setting the Date and Time

The date/time setting screen automatically appears:

- When first turning the camera on.
 - When turning the power on after leaving the camera without battery for an extended period of time.
1. Press the **POWER** button to turn on the camera.
 2. Slide the mode switch to [].
 3. Press the **▶** button to select [SETUP].
 4. Use the **▲/▼/◀/▶** buttons to select [DATE SETUP], then press the **OK** button.
 5. Press the **◀/▶** buttons to select the Year, Month, Day and Time fields.
 - To increase the value, press the **▲** button.
 - To decrease the value, press the **▼** button.
 - The time is displayed in 24-hours format.
 6. Press the **OK** button after all fields are set.

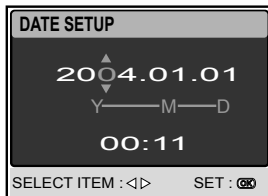
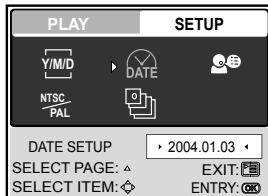
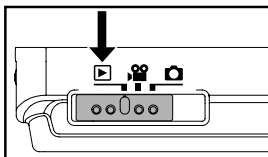

Choosing the Screen Language

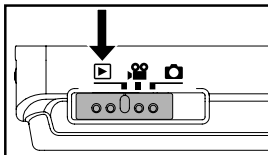

Follow the steps below to specify in which language menus and messages are to be displayed on the LCD monitor.

1. Press the **POWER** button to turn on the camera.
2. Slide the mode switch to [].
3. Press the **▶** button to select [SETUP].
4. Use the **▲/▼/◀/▶** buttons to select [LANGUAGE], then press the **OK** button.
5. Use the **▲/▼** buttons to select the language you want.
6. Press the **OK** button to confirm.



Formatting an SD Memory Card or Internal Memory

Formatting erases all images, videos, audio files and folders that are stored on the SD memory card or internal memory. Formatting is not possible if an SD memory card is locked.

1. Press the **POWER** button to turn on the camera.
2. Slide the mode switch to [] or [].
3. Press the **▶** button to select [SETUP].
4. Use the **▲/▼/◀/▶** buttons to select [FORMAT], then press the **OK** button.
5. Use the **▲/▼** buttons to select [YES], then press the **OK** button to confirm.
 - To cancel formatting, select [NO].

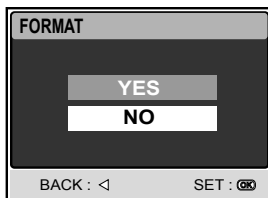
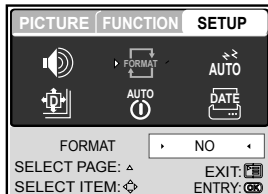
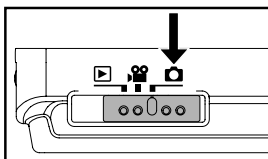

NOTE









- You should format an SD memory card with the camera before using it for the first time.
- To format the internal memory, do not insert a memory card into the camera. Otherwise, you will format the memory card.
- Formatting is an irreversible action and data cannot be recovered.
- An SD memory card with errors cannot be properly formatted.

Setting Image Resolution and Quality

Resolution and quality settings determine the file size and compression ratio for your images. These settings affect the number of images that can be stored in memory, or on a memory card.

High resolution and quality settings are recommended for printed output and situations requiring the finest detail. Lower resolution/quality images take up less memory space and are quite suitable for sharing images via e-mail, in a report, or on a web page.

To change image resolution or image quality:

1. Press the **POWER** button to turn on the camera.
2. Slide the mode switch to [].
3. Press the  button.
 - The [PICTURE] menu is displayed.
4. Use the /// buttons to select [SIZE], then press the **OK** button.
5. Use the / buttons to select the desired setting, then press the **OK** button.
6. Follow steps 4 and 5 above to set the [QUALITY].

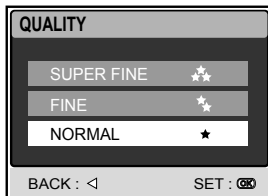
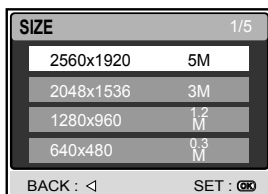





NOTE

- The possible number of shots and recording time vary according to the storage size, resolution and quality settings and the subject of the image to be captured.
- You can resize images later. (Please refer to section in this manual titled "Resizing an Image" for further details.)

■ Possible Number of Shots (Still Image)

The following table shows the approximate number of images you can capture at each setting based on a specific SD card's capacity.

Resolution	Quality	SD memory card size				
		32MB	64MB	128MB	256MB	512MB
2560 x 1920 	☆☆ SUPER FINE	9	19	39	78	158
	* FINE	18	38	78	157	315
	★ NORMAL	28	58	117	236	475
2048 x 1536 	☆☆ SUPER FINE	14	30	61	123	247
	* FINE	29	59	121	244	490
	★ NORMAL	43	89	182	366	736
1280 x 960 	☆☆ SUPER FINE	37	77	156	314	631
	* FINE	73	150	306	616	1236
	★ NORMAL	107	221	450	905	1819
640 x 480 	☆☆ SUPER FINE	141	290	588	1184	2378
	* FINE	262	539	1093	2200	4417
	★ NORMAL	366	754	1530	3080	6282
TIFF IMAGE 		2	4	8	17	34

■ Possible recording time / sec (video clip)

Resolution	SD memory card size				
	32MB	64MB	128MB	256MB	512MB
640 x 480	00:01:44	00:03:38	00:07:27	00:15:04	00:30:19
320 x 240	00:06:51	00:14:21	00:29:23	00:59:24	01:59:31



NOTE

- The above data shows standard testing results. The actual capacity varies according to the shooting conditions and settings.

CAMERA MODE

Capturing Images

1. Press the **POWER** button to turn on the camera.
2. Slide the mode switch to [📷].
3. Compose your image in the LCD monitor.
4. Press the shutter button down halfway, then press it down fully.
 - Pressing the shutter button down halfway automatically focuses and adjusts the exposure.
 - The focus-area frame turns blue when the camera is focused and the exposure is determined.
 - When the focus or exposure is not suitable, the frame of the focus area turns yellow.
 - If the photographic preview is set to "ON", the captured image is displayed while the image is being recorded onto the memory.

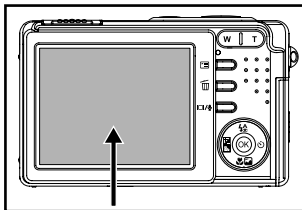

① Press down halfway

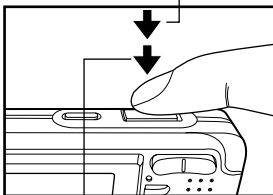







② Press down fully



- The LCD monitor darkens in strong sunlight or bright light. This is not a malfunction.
- To prevent your images from being blurred while pressing the shutter button, always hold it carefully. This is especially important when you are shooting under low lighting conditions, which your camera may decelerate the shutter speed to ensure your images are properly exposed.
- Pressing the [I/O] button changes the LCD display in the sequence of: Standard Display → Simplified Display → No Information.
- To review the last-captured image, press the **OK** button. Press the **OK** button again to return to the camera mode.







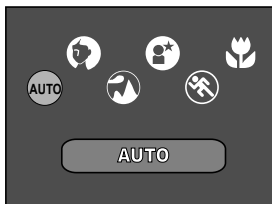
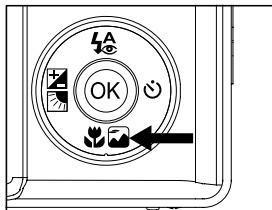

Setting the Scene Mode

This sets the scene mode for capturing images.

1. Press the **POWER** button to turn on the camera. Make sure the camera is in the [] mode.
2. Press the  button.
 - The screen of scene mode menu is displayed.
3. Use the  /  buttons to select the desired scene mode, then press the **OK** button to confirm.
 - To cancel the selection and exit from the scene mode menu, press the  /  buttons.



The table below will help you choose the appropriate scene mode:

Scene mode	Description
 AUTO	Select this mode when you want to leave the settings up to the camera to capture images with ease.
 PORTRAIT	Select this mode when you want to capture an image that makes the person stand out against a defocused (blurred) background. The default flash mode is set to [] which is effective for reducing the red-eye phenomenon.
 LANDSCAPE	Select this mode to enhance color, saturation shown in mountains, forests and other landscape scenery or to take portraits that feature a landmark in the background. The flash is fixed at [].
 NIGHT SCENE	Select this mode when you want to photograph people with an evening or night scene background.
 SPORTS	Select this mode when you want to capture fast-moving subjects.
 MACRO	Select this mode to capture close-up subject. The flash is fixed at [].





NOTE

- The description of each scene serves as a general guide. Set the digital still camera to suit your own preferences.
- The scene mode can only be set only in [] mode.

Using the Optical Zoom

Zoom photography allows you to capture images magnified up to 3x or wide-angle photography depending on the distance up to the subject. You can further enlarge the center of the screen and capture images using the digital zoom.

1. Slide the mode switch to [] or [].
2. Compose the image with the zoom button.
 - Pressing the **T** button zooms in on the subject, and enlarges the subject on the LCD monitor.
 - Pressing the **W** button provides a wider-angle image.
 - The lens position moves according to the zoom button setting.
3. Press the shutter button down halfway to set the focus and exposure, then press it down fully to capture the image.

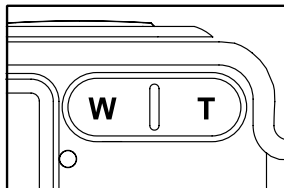









NOTE

- The zoom function cannot be used while a video clip is recording.

Using the Digital Zoom

Using a combination of 3x optical zoom and 4x digital zoom permits zoom photography up to 12x to suit the subject and the distance. Digital zoom is a compelling feature, however, the more an image is enlarged (zoomed), the more pixilated (grainer) the image will appear.

1. Slide the mode switch to [].
2. To enable the digital zoom.
 - a. Press the  button.
 - b. Select [FUNCTION] with the  button.
 - c. Select [DIGITAL ZOOM] with the // buttons, and press the **OK** button.
 - d. Select [ON] with the  or  buttons, and press the **OK** button.
 - e. Press the  button to exit from the menu screen.
 - f. To activate the digital zoom, press and hold the **T** button completely until the image on the LCD monitor expands.
3. Press the shutter button to capture a "zoomed" image.

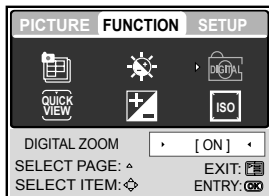







NOTE

- The zoom setting is automatically cancelled by either turning the camera off or the activation of the Auto Power Off function.



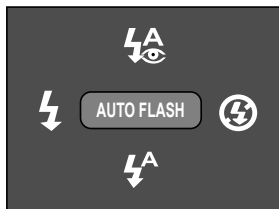
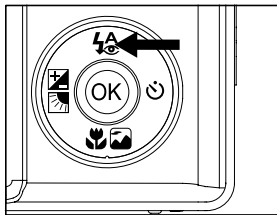

Using the Flash

The flash is designed to function automatically when lighting conditions warrant its use. You can capture an image using a flash mode suitable to your circumstances.

1. Press the **POWER** button to turn on the camera.
2. Slide the mode switch to [].
3. Press the  button.
 - The screen of flash mode menu is displayed.
4. Use the /  buttons to select the desired flash mode, then press the **OK** button.
 - To cancel the selection and exit from the flash mode menu, press the /  buttons.
 - The flash mode you set will be displayed on the LCD monitor.
5. Compose your scene and press the shutter button.









The table below will help you to choose the appropriate flash mode:

Flash mode	Description
 RED EYE	Use this mode to reduce the red-eye phenomenon when you want to capture natural-looking images of people and animals in low-light conditions. When capturing images, the red-eye phenomenon can be reduced by asking the subject (person) to look at the digital still camera or get as close to the digital still camera as possible.
 NO FLASH	Use this mode in an environment where the use of a flash is prohibited or in situations where the distance to the subject is too far away for the flash to have any effect.
 AUTO FLASH	The flash fires automatically according to the photographic conditions.
 FORCED FLASH	The flash always fires regardless of the surrounding brightness. Select this mode for recording images with high contrast (backlighting) and deep shadows.



NOTE

- In [] landscape and [] macro modes, the flash is fixed at [].
- In the capture mode [] continuous and [] AEB, the flash is fixed at [].
- The flash cannot be used in the [] mode.

Using the Self-Timer

The self-timer can be set to [OK] mode. This feature is useful for situations where you may wish to join the scene when taking group shots.

1. Secure the camera to a tripod or place it on a stable surface.
2. Press the **POWER** button to turn on the camera.
3. Slide the mode switch to [OK].
4. Toggle the  button to select the desired self-timer mode.

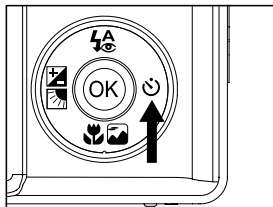
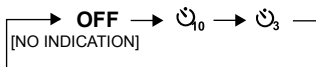

5. Compose your image and press the shutter button.
 - The self-timer function is activated and the status of countdown is displayed on the LCD monitor.
 - The self-timer LED flashes and the image will be captured after the preset time has elapsed.
 - To cancel the self-timer during operation, press the  button.

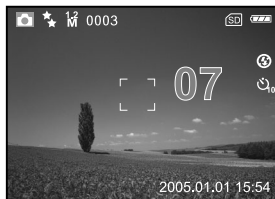

NOTE

- The self-timer setting is automatically cancelled after an image is captured.

Adjusting the Exposure

Images can be captured with the scene intentionally made brighter or darker. These settings are used when a suitable brightness (exposure) cannot otherwise be obtained in circumstances where the difference in brightness between the subject and the background (the contrast) is large, or when the subject that you wish to capture is very small within the scene. Exposure can be set in 0.3 EV units.

Quick Selection

- Slide the mode switch to [📷] and press the [Fn] button.
 - Each press of the [Fn] button displays the setting in the order of [Blank], [Fn] Exposure Compensation, and [Fn] Backlight Correction.
- Set the exposure value with the ▲/▼ buttons.
 - Press the ▲ button to increase the value.
 - Press the ▼ button to decrease the value.
 - The setting range of the exposure compensation is as follows: -2.0, -1.7, -1.3, -1.0, -0.7, -0.3, 0, +0.3, +0.7, +1.0, +1.3, +1.7, +2.0

Selection in the [FUNCTION] menu

- Slide the mode switch to [📷] or [📹].
- Press the [Fn] button, then use the ▶ button to select the [FUNCTION] menu.
 - In Movie mode, select [MOVIE].
- Use the ▲/▼/◀/▶ buttons to select [EXPOSURE], then press the OK button.
- You can use the ▲/▼ buttons to set the exposure value from -2.0 EV to +2.0 EV, then press the OK button.
 - To reactivate auto exposure, select [0EV] in step 4.
- To exit from the menu, press the [Fn] button.

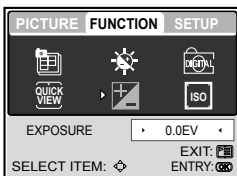
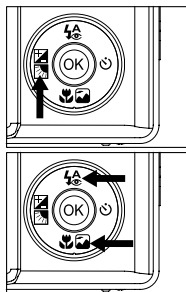

[📷] Mode





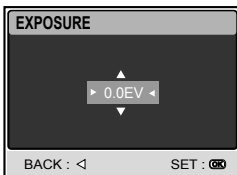





[📹] Mode



Setting the White Balance

The human eye adapts to changes in light so that white objects still appear white even when the light changes. With a digital camera, however, the color of the subject is influenced by the color of the light surrounding it. This color adjustment is called "white balance adjustment". This setting allows you to set the white balance when capturing images under specific lighting conditions.



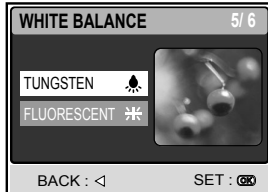
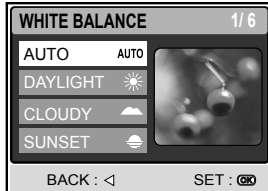
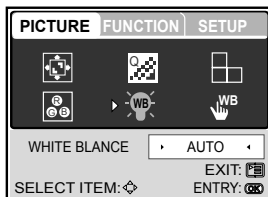





1. Slide the mode switch to [].
2. Press the  button. The [PICTURE] menu appears.
3. Use the /// buttons to select [WHITE BALANCE], then press the **OK** button.
4. Use the / buttons to select the desired setting.
5. To exit from the menu, press the  button.



ADVANCED CAPTURE

Continuous Capture

In continuous capture mode, you can capture a rapid sequence of images with one press of the shutter button. This function is very useful for photographing objects in motion where it is difficult to determine the precise moment of capture. Afterwards, you may review the sequence of images to select the best one.

1. Slide the mode switch to [].
2. Press the  button, then use the  button to select the [FUNCTION] menu.
3. Use the  button to select [CAPTURE MODE], then press the **OK** button.
4. Use the  /  buttons to select [CONTINUOUS ], then press the **OK** button.
5. To exit from the menu, press the  button.
 - The  indicator is displayed on the monitor screen.
6. Press the shutter button down halfway to lock the focus.
7. Press the shutter button down all the way to capture images.
 - Capturing will stop when the shutter button is released.

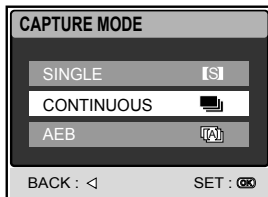
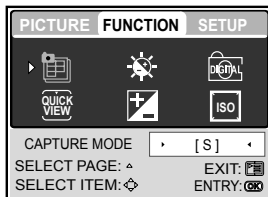









NOTE

- The maximum number of continuous shots: 5.
- In CONTINUOUS mode, the flash mode is set to **NO FLASH** automatically.

Auto-Exposure Bracketing (AEB)

Auto-exposure bracketing is an effective technique when it is difficult to determine the precise exposure of a scene. Using AEB the camera will capture a sequential burst of three images at three different exposure settings. Afterwards, you may review the sequence of images to select the best exposure.

1. Slide the mode switch to [].
2. Press the  button, then use the  button to select the [FUNCTION] menu.
3. Use the  button to select [CAPTURE MODE], then press the **OK** button.
4. Use the / buttons to select [AEB ]], then press the **OK** button.
5. To exit from the menu, press the  button.
 - The  indicator is displayed on the monitor screen.
6. Press the shutter button to capture images.

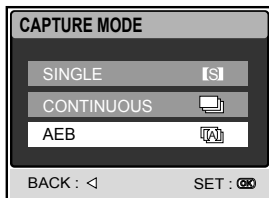
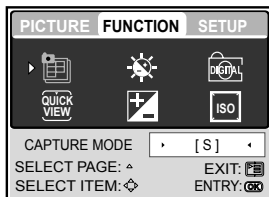







NOTE

- In AEB mode, the flash mode is set to **NO FLASH** automatically.

Adjusting White Balance Manually

Manual white balance lets you configure the digital still camera for a particular light source and other conditions. Note that you must perform manual white balance under the same conditions you will be shooting. You must also have a piece of white paper or other similar object on hand in order to perform this function.

- Slide the mode switch to [].
- Press the  button. The [PICTURE] menu appears.
- Use the  /  buttons to select [MANUAL WB], then press the **OK** button.
- Point the camera at an enclosed gray card for which you can set the white balance.
 - This starts the white balance adjustment procedure.
- Use the  /  buttons to select [EXECUTE], then press the **OK** button to confirm.
 - The procedure of manual white balance is complete.
 - If you wish to cancel [MANUAL WB] setting, select [CANCEL].
- To exit from the menu, press the  button.

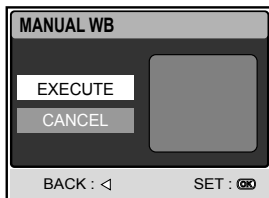
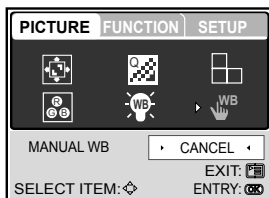

PLAYBACK MODE - THE BASICS

In the playback mode, you can view, magnify, delete images, play video clips , or run a slide show. This mode also provides a thumbnail image display, allowing you to quickly search for the desired image.

Viewing Images

1. Press the **POWER** button to turn on the camera.
2. Slide the mode switch to [].
3. Use the ◀/▶ buttons to select the desired images.
 - To view the previous image, press the ◀ button.
 - To view the next image, press the ▶ button.
 - Pressing the ▲/▼ buttons during image playback rotate the image 90 degrees. The ▲ button rotates the image clockwise, whereas the ▼ button rotates the image counterclockwise.

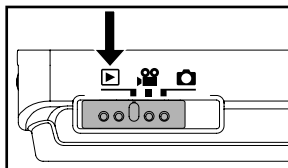

90° Counterclockwise



0° (Original)











90° Clockwise



- If there is no image stored in the internal memory or memory card, the [NO PICTURE] message appears on the monitor.
- Pressing the  button while playing back images changes the LCD display in the sequence of: Standard display → Detailed display → No information.

Magnifying Images

While reviewing your images, you may enlarge a selected portion of an image. This magnification allows you to view the details. Images displayed can be enlarged in 8 times enlargement.

- Slide the mode switch to [].
- Use the  /  buttons to select the desired images.
 - To view the previous image, press the  button.
 - To view the next image, press the  button.
- Adjust the zoom ratio using the zoom button.
 - To enlarge the selected image, press the **T** button.
 - To return to normal magnification, press the **W** button.
 - The magnification factor is displayed on the LCD monitor.
- To view different portion of the images, press the  /  /  /  buttons to adjust the display area.
 - You will see a white frame with a pink box inside. The white frame indicates the entire image, while the pink box shows the location of the currently enlarged area.
- To return to regular display, toggle the **W** button until the regular display appears on the screen.

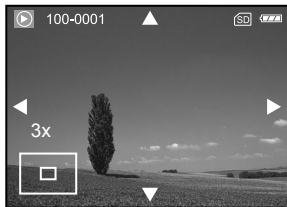













NOTE

- The range of magnification factor is: 1.5x, 2.0x, 2.5x, 3.0x, 3.5x, 4.0x, 4.5x, 5.0x, 5.5x, 6.0x, 6.5x, 7.0x, 7.5x and 8.0x.



Thumbnail Display (Index Playback)

This function allows you to view four or nine thumbnail images on the LCD monitor simultaneously so you may search for a particular image.

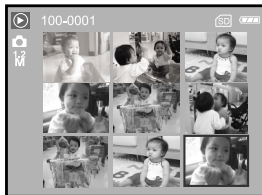
1. Slide the mode switch to [].
2. Press the  button to enter the [PLAY] menu. Select [THUMBNAIL] with the  /  /  buttons, then press the **OK** button.
3. Use the  /  buttons to choose the desired number of thumbnail images to be displayed, then press the **OK** button.
 - Press the  button to exit from [PLAY] menu.
4. Press the **W** button.
 - Four or nine thumbnail images are displayed simultaneously.
5. Use the  /  /  /  buttons to select the image to be displayed at regular size, then press the **OK** button to display the selected image on full screen.











NOTE

- As appropriate, the  or  icon are displayed in a thumbnail display.

Slideshow Display





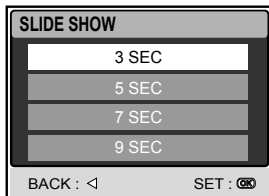





The slideshow function enables you to play back your images automatically in sequential order. This is very useful and entertaining feature for reviewing recorded images and for presentations.

1. Slide the mode switch to [].
2. Press the  button to enter the [PLAY] menu.
3. Select [SLIDE SHOW] with the /// buttons, then press the **OK** button.
4. Use the / buttons to set the slideshow interval, then press the **OK** button.
 - The slide show starts.
 - Each video clip is presented by the first frame of the video clip.
 - To stop the slide show display, press the **OK** button.



Resizing an Image

You can change the image size of a captured image to one of the following: 2560 x 1920 pixels, 2048 x 1536 pixels, 1280 x 960 pixels and 640 x 480 pixels.

1. Slide the mode switch to [].
2. Use the  /  buttons to select the desired image you want to resize.
3. Press the  button to enter [PLAY] menu.
4. Select [RESIZE] with the /// buttons, then press the **OK** button.
5. Use the / buttons to select the desired setting, then press the **OK** button to confirm.

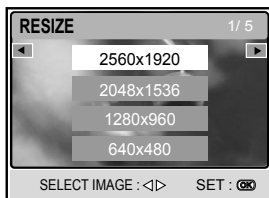

MOVIE MODE

Recording Video Clips

1. Press the **POWER** button to turn on the camera.
2. Slide the mode switch to [].
3. Compose the image with the zoom button, if desired.
 - Optical zoom should be set while composing the scene.
 - Optical zoom cannot be used during movie capture.
4. Press the shutter button to start recording.
5. Press the shutter button again to stop recording.

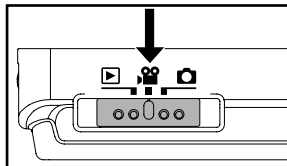

NOTE

- The flash and self-timer cannot be used in [] mode.
- While a video is being recorded to an SD card, do not open the battery/SD card cover, nor remove the battery or SD card. Doing so might damage the SD card or destroy the data.

Playing Back Video Clips

1. Slide the mode switch to [].
2. Use the ◀/▶ buttons to go through the images until the video clip you want to play back is displayed.
 - To view the previous image, press the ◀ button.
 - To view the next image, press the ▶ button.
3. Press the shutter button to start playing back a video clip.
 - To pause or resume video playback, press the shutter button.
 - To stop playback, press the **OK** button.
 - Use the ▼ button to start fast-reverse playback.
 - Use the ▲ button to start fast-forward playback.



NOTE

- The zoom function cannot be activated while playing back video clips.
- To play back video clips on the computer, we recommend you to use Windows Media® Player 9.0 (WMP 9.0). You can download WMP from the website at www.microsoft.com.
- Pressing the  button in video playback mode changes the LCD display in the sequence of: Indicators on → Indicators off.

PLAYBACK MODE - ADVANCED FUNCTIONS

Playing Back Images/Video Clips on TV

You can play back your images and videos on a TV screen. Before connecting to any device, make sure to select the broadcast standard that matches the video output system of the video equipment to which you are going to connect the digital still camera. It is recommended you use an AC power adapter while playing back recorded images and videos on TV.

1. Slide the mode switch to [].
2. Connect one end of the A/V cable to the conversion adapter terminal of the camera.
 - If you use the conversion adapter to connect the A/V cable, insert the conversion adapter into the conversion adapter terminal of the camera first, and then connect one end of the A/V cable to the A/V terminal of the conversion adapter.
3. Connect the other end to the A/V input socket of the TV set.
4. Turn the TV and digital still camera on.
5. Play back the still images/video clips.
 - The method of operation is the same as playing back still images and video clips on the digital still camera.

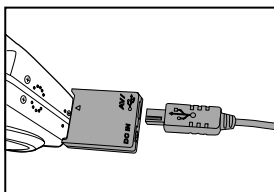
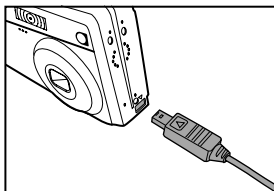



Deleting Images/Video Clips

Use this function to delete one or all images/video clips stored in the internal memory or memory card. Please note that the deleted images or video clips cannot be recovered.



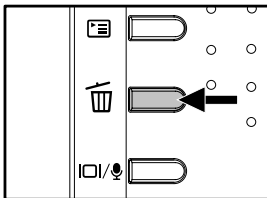

Immediate Erasure (Quick Delete Function)

The quick delete function lets you delete the last image captured.

1. Slide the mode switch to [📷] or [📹].
2. Press the  button.
 - The last image and delete message appears on the screen.
3. Use the  /  buttons to select [YES], then press the **OK** button.
 - If you wish to cancel the deletion, select [NO].









To delete a single image/video clip in playback mode

1. Slide the mode switch to [📷].
2. Use the  /  buttons to select the image you want to delete.
3. Press the  button.
4. When the delete message appears, use the  /  buttons to select [YES], then press the **OK** button.
 - If you wish to cancel the deletion, select [NO].



To delete all images/video clips at once

1. Slide the mode switch to [📷].
2. Press the  button to enter [PLAY] menu. Select [DELETE ALL] with the  /  /  /  buttons, then press the **OK** button.
3. To confirm the deletion of all images, use the  /  buttons to select [YES], then press the **OK** button.
 - The message "NO PICTURE" appears on the LCD screen.















NOTE

- Protected images cannot be deleted.

Protecting Images/Video Clips

The "PROTECT" function allows you to set data to read-only to prevent images from being erased by mistake.

- Slide the mode switch to [].
- Press the  button to enter [PLAY] menu. Select [PROTECT] with the /// buttons, then press the **OK** button.
- Use the / buttons to select the desired setting, then press the **OK** button.
 - [ONE IMAGE]: Protect one image/video.
 - [ALL IMAGES]: Protect all images/videos (at once).
 - [EXIT]: Exit from this menu.
- Use the / buttons to select [LOCK], then press the **OK** button.
 - Press the  button to return to the playback mode.
 - The protect icon  is displayed on each protected video and image.

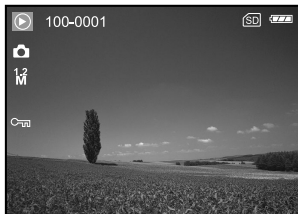



Canceling protection

To cancel protection for an image or video, display the image or video for which you wish to remove the protection.





- Perform the above steps 1-3.
- Use the / buttons to select [UNLOCK], then press the **OK** button.

Setting the DPOF

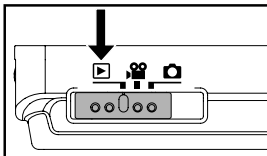



DPOF (Digital Print Order Format) allows you to embed printing information on your memory card. Files saved in the DPOF format can be printed using compatible printers or through a laboratory printing device.

1. Slide the mode switch to [].
2. Press the  button to enter [PLAY] menu.



3. Select [DPOF] with the /// buttons, then press the **OK** button.
 - The DPOF setup screen is displayed.



4. Use the  /  buttons to select the desired image you want to set DPOF.
5. Use the / buttons to select [ONE IMAGE] or [ALL IMAGES], then press the **OK** button.

[ONE IMAGE]: To configure print settings for a single image.

[ALL IMAGES]: To configure print settings for all images.

[RESET]: Returns all basic settings to the camera's default settings.

[EXIT]: To exit the DPOF menu.





6. Use the ▲/▼ buttons to select [QUANTITY], [DATE] and [ENABLE], then press the **OK** button to configure the setting.

[QUANTITY]: Allows you to select image quantity (0~99). Use the ▲/▼ buttons to set the image quantity and press the **OK** button.

[DATE]: The captured date can be printed directly on the images. Select [SET] or [CANCEL] with the ▲/▼ buttons. Press the **OK** button.

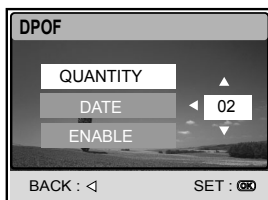
[ENABLE]: Allows you to confirm your setting which will be saved in the memory card. Select [ENABLE] or [DISABLE] with the ▲/▼ buttons, then press the **OK** button.



7. Press the  button to return to the image playback mode.
8. The  is displayed on each image that have set up DPOF settings.













9. To cancel the DPOF setting, go back to step 4 to select [RESET] with the ▲/▼ buttons.

**NOTE**

- If you configure print settings for all images, the [QUANTITY] option will not be available.
- The DPOF function can be used only on still images that are saved on memory cards.

Changing the Camera Startup Screen

This feature lets you specify one of your recorded images as your startup screen, which will be displayed on the monitor whenever you turn on the camera.



1. Slide the mode switch to [].
2. Press the  button to enter [PLAY] menu.
3. Use the /// buttons to select [CHANGE LOGO], then press the **OK** button.
4. Use the / buttons to select the desired image you want to set as the startup screen.
5. Use the / buttons to select [EXECUTE], then press the **OK** button to confirm.
 - The new screen will welcome you the next time you turn on the camera.



AUDIO MODE

The digital still camera allows you to record and play back voice files.

Recording Voice Files

1. Press the **POWER** button to turn on the camera.
2. Slide the mode switch to [].
3. Press the  button to access Audio mode.
4. Press the shutter button to start recording.
 - A ● indicator is displayed on the screen.
 - Recording stops when you press the shutter button again.

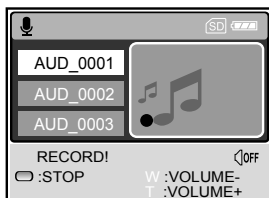
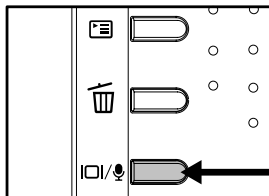
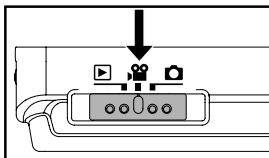

Playing Back a Voice File

1. Perform the above steps 1-3.
 - Voice playlist appears on the screen.
2. Use the ▲/▼ buttons to select the voice file you want to play.
3. Press the **OK** button to start playback of the voice file through the camera's speaker.
 - To pause playback, press the  button.
 - To resume playback, press the **OK** button.
 - To stop playback, press the **OK** button again.





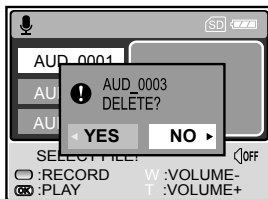

Deleting a Voice File

1. Make sure the camera is in Audio mode.
2. In Audio mode, use the ▲/▼ buttons to select the voice file you want to delete.
3. Press the  button to delete the selected voice file.
4. When the delete message appears, use the ◀/▶ buttons to select [YES], and then press the **OK** button.
 - If you wish to cancel the deletion, select [NO].



■ Button operations in Audio mode

To	Press	Functional Description
Power on/off	POWER	Press the POWER button to turn on/off the camera.
Start/stop voice recording	Shutter button	Press the shutter button to start or stop recording.
Select previous/next voice file	▲ / ▼	Use the ▲/▼ buttons to choose previous or next file and then press the OK button to play.
Start/stop playback of a voice file	OK	Press the OK button to start or stop playback of a voice file
Adjust audio volume	Zoom button	Press T or W to increase or decrease audio volume.
Pause playback of a voice file		Press the  button to pause playback of a voice file.
Delete a voice file		Press the  button to delete voice files.

TRANSFERRING FILES FROM YOUR DIGITAL STILL CAMERA TO COMPUTER

After using USB cable to establish a USB connection between the camera and your computer, you can use your computer to share recorded images/video clips/voice files with your family or friends via e-mail or post them on the Internet. In order to do this, you must install the USB driver onto your computer first. Before you start to install the USB driver, you need to check whether your system meets the following minimum requirements.

	System Requirements (Windows)	System Requirements (Macintosh)
CPU	Pentium 166 MHz processor or higher	PowerPC G3/G4
OS	Windows 98/98SE/ME/2000/XP	OS 9.0 or higher
Memory	32MB (64MB RAM recommended)	32MB (64MB RAM recommended)
Free Space on Hard Disk	128MB hard disk space	128MB hard disk space
Required Devices	A CD-ROM drive An available USB port	A CD-ROM drive An available USB port
Display	Color Monitor (800x600, 24-bit or higher recommended)	Color Monitor (800x600, 24-bit or higher recommended)

Step 1: Installing the USB driver

Windows 98/98SE computers

The USB driver on the supplied CD-ROM is exclusively for Windows 98 and 98SE computers. Installing the USB driver on computers running Windows 2000/ME/XP is not necessary.

1. Insert the CD-ROM that came with the camera into your CD-ROM drive.
2. When the welcome screen appears, click **"INSTALL USB DRIVER"**. Follow the on-screen instructions to complete the installation.
3. After the USB driver has been installed, restart your computer.



Macintosh OS 9.0 computers

For Mac OS 9.0 or higher, the computer will automatically recognize the digital still camera and load its own USB drivers.

Step 2: Connecting the digital still camera to your computer

1. Connect one end of the USB cable to the conversion adapter terminal of the camera.
 - If you use the conversion adapter to connect the USB cable, insert the conversion adapter into the conversion adapter terminal of the camera first, and then connect one end of the USB cable to the USB terminal of the conversion adapter.
2. Connect the other end of the USB cable to an available USB port on your computer.
3. Turn on the camera.
 - The [USB] screen is displayed.
4. Use the ▲/▼ buttons to select [PC], then press the **OK** button.
5. There will be a new "Removable Disk" icon detected in "My Computer", which contains your recorded images/video clips/audio files.

(For **Mac users**, double-click the [untitled] or [unlabeled] disk drive icon on our desktop.)

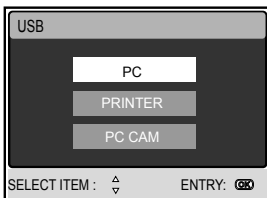
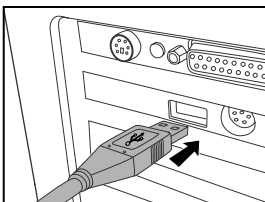
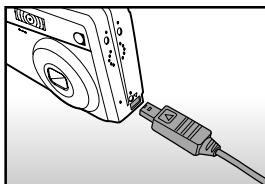

NOTE

- When connecting to the computer, you must use the battery or an AC power adapter.

Step 3: Downloading images, videos or voice files

When the digital still camera is turned on and connected to your computer, it is considered a disk drive, just like a floppy disk or a CD. You can download (transfer) images by copying them from the "Removable disk" ("untitled" or "unlabeled" disk on a Macintosh) to your computer hard drive.

■ Windows

Open the "removable disk" and double click on the DCIM / CAMERA folder to open it to find more folders. Your images are inside these folder(s). Select the desired still images / video clips /audio files and then choose "Copy" from the "Edit" menu. Open the destination location (folder) and choose "Paste" from the "Edit" menu. You may also drag and drop image files from the digital still camera to a desired location.

■ Macintosh

Open the "untitled" disk icon, and the destination location on your hard disk. Drag and drop from the digital still camera to the desired destination.



NOTE

- Memory card users may prefer to use a memory card reader (highly recommended).
- A video playback application is not included with the package. Make sure that a video playback application has been installed in your computer.

CONNECTING TO A PICTBRIDGE COMPLIANT PRINTER

If a printer that supports PictBridge is available, images can be printed by connecting the digital still camera directly to the PictBridge-compatible printer without using a computer.

Connecting the camera to the printer

1. Connect the USB port on the camera and the USB jack on the printer with the supplied USB cable, then turn on your camera and the printer.
 - The "USB" screen is displayed.
2. Use the ▲/▼ buttons to select [PRINTER], then press the **OK** button.

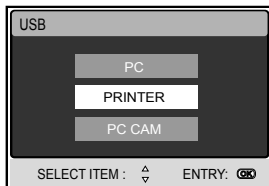

Printing images

When the camera is properly connected to a PictBridge compliant printer, the [PRINT MODE SELECT] screen is displayed on the monitor. Use the ▲/▼ buttons to select the print mode.

- **In [PRINT] Mode:** Lets you print the specified image with PictBridge.
1. Use the ▲/▼ buttons to select the [PRINT] mode, then press the **OK** button.
 - The [PRINT PAPER] screen is displayed.

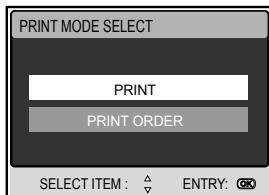

2. Use the ► button to access in the selection of paper setting, then press the **OK** button to confirm.

[SIZE]:

You may select the desired item depending on the type of printer being used.

[BORDERLESS]: You may select the desired item depending on the type of printer being used.

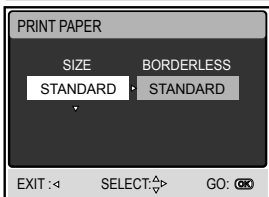

3. Use the ◀/▶ buttons to select the image you want to print, then press the ▼ button to set **MORE** print reservations.
4. Use the ▲/▼ buttons to select the desired item, then press the **OK** button.
 - Use the ▲/▼ buttons to change the setting, then press the **OK** button to confirm.

[QUANTITY] : Specifies the number of prints. You can select up to 10.

[DATE]: If you select [WITH], images are printed with the date.

[FILE NAME]: If you select [WITH], images are printed with the file name.

[EXIT]: To cancel the print settings, use the ▲/▼ buttons to select [EXIT].
5. After configuring the print settings, you can still use the ◀/ ▶ buttons to change the image that you want to print. Then, press the **OK** button to print.
6. Use the ▲/ ▼ buttons to select [PRINT], then press the **OK** button to confirm.
7. The printing starts, and the message "TRANSFERRING" is displayed on the screen. The message disappears after the printing is finished.
8. Pressing the **OK** button during print data transfer displays the screen for selecting whether to [CONTINUE] or [CANCEL] printing.

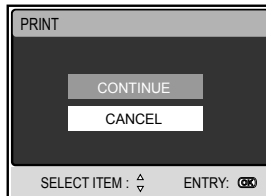
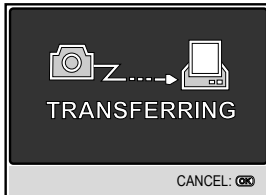
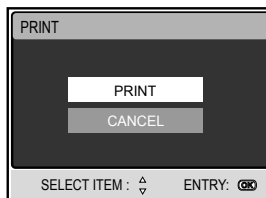
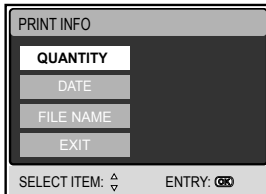

- In **[PRINT ORDER] Mode**: This function lets you print the specified images that have configured DPOF settings.

1. Use the ▲/▼ buttons to select the **[PRINT ORDER]** mode, then press the **OK** button.

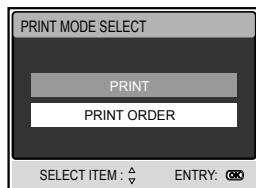

2. Use the ► button to access in the selection of paper setting, then press the **OK** button to print.

[SIZE]: You may select the desired item depending on the type of printer being used.

[BORDERLESS]: You may select the desired item depending on the type of printer being used.

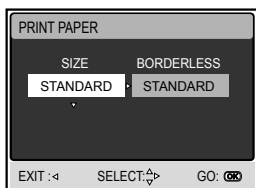

3. Use the ▲/▼ buttons to select **[PRINT]**, then press the **OK** button to confirm.

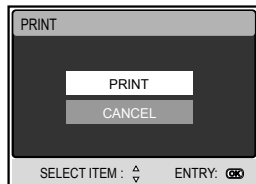

4. The printing starts, and the message "TRANSFERRING" is displayed on the screen. The message disappears after the printing is finished.

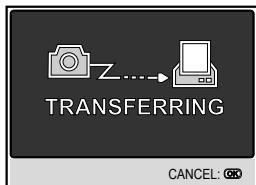

5. Pressing the **OK** button during print data transfer displays the screen for selecting whether to **[CONTINUE]** or **[CANCEL]** printing.

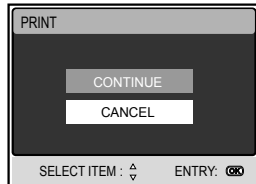

USING THE DIGITAL STILL CAMERA AS A PC CAMERA

Your digital still camera can act as a PC camera, which allows you to video conference with business associates, or have a real-time conversation with friends or family. To use the digital still camera for video conferencing, your computer system must include the items as below:

- Microphone
- Sound card
- Speakers or headphones
- Network or Internet connection



NOTE

- Video conferencing (or video editing) software is not included with the digital still camera.
- This mode is not supported for Mac.

Step 1: Installing the PC camera driver

The PC-camera driver included in the CD-ROM is exclusively for Windows. The PC camera function is not supported for Mac platforms.

1. Insert the CD-ROM that came with the camera into your CD-ROM drive.
2. When the welcome screen appears, click "**DRIVER For PC CAM**". Follow the on-screen instructions to complete the installation.
3. After the driver installation is completed, restart your computer.



Step 2: Connecting the digital still camera to your computer

1. Connect one end of the USB cable to the conversion adapter terminal of the camera.
 - If you use the conversion adapter to connect the USB cable, insert the conversion adapter into the conversion adapter terminal of the camera first, and then connect one end of the USB cable to the USB terminal of the conversion adapter.
2. Connect the other end of the USB cable to an available USB port on your computer.
3. Turn on the camera.
 - [USB] screen is displayed.
4. Use the ▲/▼ buttons to select [PC CAM], then press the **OK** button.
5. Position the digital still camera steadily on top of your computer monitor or use a tripod.

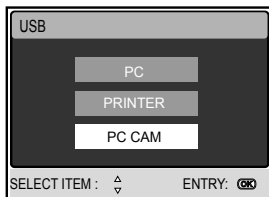

NOTE

- When using this digital still camera as a PC camera, you must use the battery or an AC power adapter.

Step 3: Running your application software (i.e. Windows NetMeeting)

To use Windows NetMeeting for videoconferencing:

1. Go to **Start → Programs → Accessories → Communications → NetMeeting** to launch the NetMeeting program.
2. Click the **Start Video** button to view live video.
3. Click the **Place Call** button.
4. Type the e-mail address or the network address of the computer that you are calling.
5. Click **Call**. The person that you are calling must also have Windows NetMeeting running and be willing to accept your call to start the videoconference.



NOTE

- The video resolution for video conferencing applications is generally 320 x 240.
- For more information about the operation of video conference application software, refer to its respective help documentation.

EDITING SOFTWARE INSTALLATION

Installing Photo Explorer

Photo Explorer provides a simple and efficient way to transfer, browse, modify and distribute digital media. Acquire photos, video or sound clips from various digital device types and easily browse or add personal descriptions; make timely modifications; or distribute the media through the medium of your choice: E-mail, Print, Slideshow Presentations. It is an indispensable all-in-one tool for owners of digital cameras, WebCams, DV camcorders, scanners, or anyone who strives to effectively organize a large collection of digital media.

1. Insert the CD-ROM that came with the camera into your CD-ROM drive.
2. When the welcome screen appears, click **"INSTALL Photo Explorer 8.0"**. Follow the on-screen instructions to complete the installation.



NOTE

- For more information about the operation of Photo Explorer application software, refer to its help documentation.
- For Windows 2000/XP users, please make sure to install and use the Photo Explorer in "Administrator" mode.
- Photo Explorer is not supported on the Mac. iPhoto is recommended.

Installing Photo Express

Ulead® Photo Express is complete photo project software for digital images. The step-by-step workflow, visual program interface, and in-program help assist users in creating exciting photo projects. Acquire digital photos effortlessly from digital cameras or scanners. Organize them conveniently with the Visual Browse mode. Use hundreds of ready-to-use templates such as albums, cards, posters, slideshows, and more. Edit and enhance images with photo editing tools, photographic filters, and special effects. Embellish projects by adding creative design elements such as frames, callouts, and stamp objects. Share results with family and friends via e-mail and multiple print options.

1. Insert the CD-ROM that came with the camera into your CD-ROM drive.
2. When the welcome screen appears, click **“INSTALL Photo Express 5.0”**. Follow the on-screen instructions to complete the installation.



NOTE

- For information on how to use Photo Express to edit and retouch your recorded images, please refer to its online help.
- For Windows 2000/XP users, make sure to install and use the Photo Express while logged in as a user with an Administrator account.
- Photo Express is not supported on the Mac.





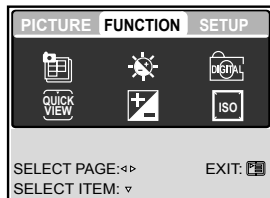
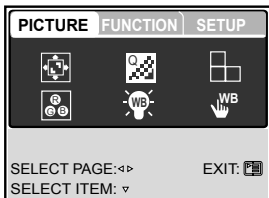

















MENU OPTIONS

Camera Menu











1. Slide the mode switch to [].
2. Press the [] button to access in Camera menu, then use the ◀/▶ buttons to select [PICTURE] / [FUNCTION] menu.
3. Use the ▲/▼/◀/▶ buttons to select the desired item in [PICTURE] / [FUNCTION] menu, then press the **OK** button.
4. To exit from the menu, press the [] button.







■ Camera Menu - PICTURE Settings

Item	Functional Description
SIZE 	Sets the size of the image that will be captured. *  2560 x 1920 *  2048 x 1536 *  1280 x 960 *  640 x 480 *  TIFF IMAGE
QUALITY 	Sets the quality (compression rate) at which the image is captured. *  SUPER FINE *  FINE *  NORMAL
SHARPNESS 	Sets the level of image sharpness. *  HIGH *  NORMAL *  LOW
COLOR 	Sets the color of the image that will be captured. * NORMAL * B&W * SEPIA
WHITE BALANCE 	Sets the white balance when capturing images under specific lighting conditions. * AUTO AUTO *  DAYLIGHT *  CLOUDY *  SUNSET *  TUNGSTEN *  FLUORESCENT
MANUAL WB 	Allows for manually setting the white balance. Manual WB is convenient when the white balance presets do not offer a good match to your specific lighting conditions. Before selecting [EXECUTE], select a white subject (such as a piece of white paper) that will be used to set the white balance. * EXECUTE/CANCEL





■ Camera Menu - FUNCTION Settings

Item	Functional Description
CAPTURE MODE 	Sets the recording method at the time of capturing images. *  SINGLE *  CONTINUOUS *  AEB
LCD BRIGHT 	Selects a brightness level for the LCD monitor. The adjustment range is from -5 to +5.
DIGITAL ZOOM 	Enables or disables digital zoom. * ON/OFF
QUICK VIEW 	Displays a captured image on LCD monitor immediately after you have captured the image. * ON/OFF
EXPOSURE 	Set to obtain the correct exposure when the subject is much brighter or darker than the background. The exposure compensation value can be set in the range from -2.0EV to +2.0EV.
ISO 	Sets the light sensitivity for capturing images. When the sensitivity is raised (the ISO figure is increased), the camera sensitivity is enhanced for low-lighting, but your images will appear more pixilated (grainy). *AUTO/50/100/200

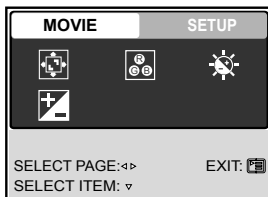
Movie Menu

1. Slide the mode switch to [].
2. Press the  button to access in [MOVIE] menu.
3. Use the /// buttons to select the desired setting, then press the **OK** button.
4. To exit from the menu, press the  button.







Item	Functional Description
SIZE 	Sets the size of the image that will be recorded. * 640 x 480 * 320 x 240
COLOR 	Refer to the section in this manual titled " COLOR " in "Camera Menu - PICTURE Settings" for further details.
LCD BRIGHT 	Refer to the section in this manual titled " LCD BRIGHT " in "Camera Menu - FUNCTION Settings" for further details.
EXPOSURE 	Refer to the section in this manual titled " EXPOSURE " in "Camera Menu - FUNCTION Settings" for further details.

Play Menu



1. Slide the mode switch to [].
2. Press the [] button to access in [PLAY] menu.
3. Use the / / / buttons to select the desired setting, then press the **OK** button.
4. To exit from the playback menu, press the [] button.

Item	Functional Description
SLIDE SHOW 	This function allows you to play back your images automatically in sequential order as a slide show. This is a very useful feature for reviewing recorded images and for presentations. Refer to the section in this manual titled “Slideshow Display” for further details. * 3SEC/5SEC/7SEC/9SEC
PROTECT 	Set the data to read-only to prevent images from being erased by mistake. Refer to the section in this manual titled “Protecting Images/Video Clips” for further details.
DELETE ALL 	Delete all files. * YES/NO
COPY TO CARD 	Allows you to copy your files from the digital still camera's internal memory to a memory card. You can only do this if you have a memory card installed and some files in internal memory. * YES/NO

Item	Functional Description
THUMBNAIL 	Allows you to view 4 or 9 thumbnail images on the LCD monitor at the same time, which can quickly search for the image that you want. * 4/9
RESIZE 	Changes the size of a recorded image. * 2560 x 1920 * 2048 x 1536 * 1280 x 960 * 640 x 480 * EXIT
CHANGE LOGO 	Allows you to specify one of your recorded images as your startup screen, which will be displayed on the monitor whenever you turn on the camera. * EXECUTE/CANCEL
DPOF 	Refer to the section in this manual titled "Setting the DPOF" for further details.

Setup Menu (In Camera and Movie Modes)

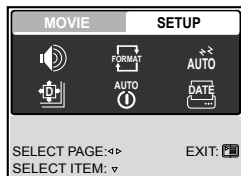
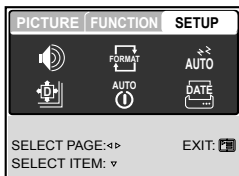





1. Slide the mode switch to [] or [].
2. Press the [] button.
3. Press the []/[] buttons to select the [SETUP] menu.
4. Use the []/[]/[]/[] buttons to select the desired item, then press the **OK** button.

Item	Functional Description
SPEAKER 	Enables or disables the sounds associated with camera button functions. * ON/OFF
FORMAT 	Erases all data and reformats the internal memory or the SD card loaded in your camera. Protected images are also erased. An SD card cannot be formatted if it is write-protected. Refer to the section in this manual entitled "Formatting an SD Memory Card or Internal Memory" for further details. * YES/NO
SLEEP 	If the camera goes unused for a certain period of time while the camera is powered on, it switches to idle mode. If the camera is idle, re-activate it by pressing any button. * OFF / 30SEC / 1MIN. / 2MIN.
RESET 	Returns all basic settings to the digital still camera's default settings. The time setting will not be reset. * YES/NO
POWER OFF 	If no operation is performed for a specific period of time, the camera will automatically turn off. This feature is useful to reduce battery consumption. * OFF / 3MIN. / 5MIN. / 10MIN.
DATE PRINT 	The date of recording can be printed directly on still images. This function must be activated before the image is captured. * ON/OFF

Setup Menu (In Playback Mode)

1. Slide the mode switch to [▶].
2. Press the  button.
3. Press the ◀ / ▶ buttons to select the [SETUP] menu.
4. Use the ▲/▼/◀/▶ buttons to select the desired item, then press the **OK** button.



Item	Functional Description
DATE TYPE 	Sets the displayed type of date and time on the screen. * [Y/M/D]: Year/Month/Day * [D/M/Y]: Day/Month/Year * [M/D/Y]: Month/Day/Year
DATE SETUP 	Sets the date and the time. Refer to the section in this manual titled “Setting the Date and Time” for further details.
LANGUAGE 	Sets the language that is displayed on the LCD monitor. Refer to the section in this manual titled “Choosing the Screen Language” for further details.
VIDEO OUT 	Sets video output standard of the camera so you may connect your camera to video equipment. * PAL / NTSC
VERSION 	Displays the firmware version of the camera.

CONNECTING YOUR CAMERA TO OTHER DEVICES

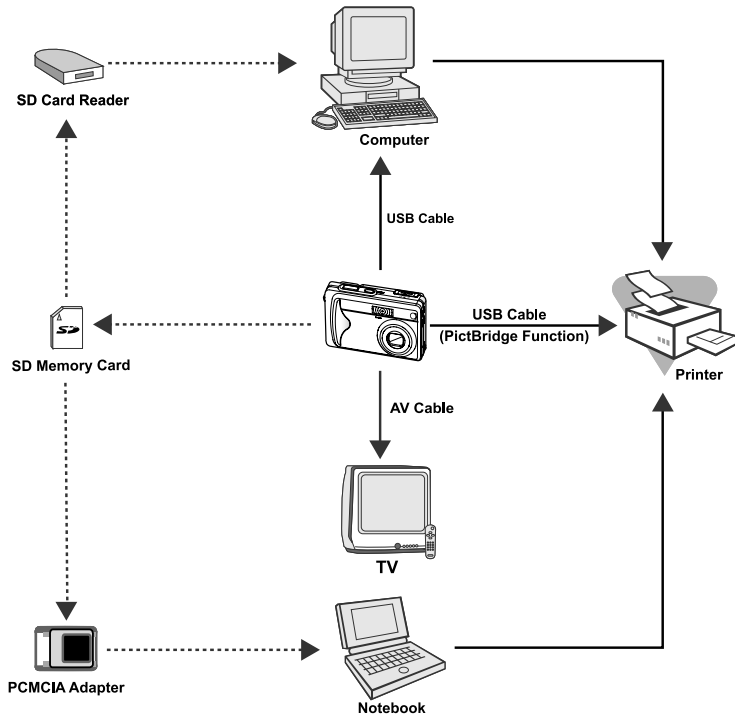

SPECIFICATIONS

Item	Description
Image sensor	5.2 megapixel CCD sensor
Image resolution	Still image: 2560 x 1920, 2048 x 1536, 1280 x 960, 640 x 480 Video clip: 640 x 480, 320 x 240
Image quality	Still image: SUPER FINE, FINE, NORMAL
Recording media	9MB internal memory SD memory card (up to 512MB)
Compression format	MPEG 4 SP (Video), IMA-ADPCM (Audio)
File format	JPEG, TIFF, ASF (Video)
Lens	F-no.: 2.8 (Wide) / 4.9 (Tele) Focal length: 5.4mm-16.2mm
Focus range	Normal: 0.5m-infinity Wide: 0.06m-0.4m (in Macro mode) Tele: 0.35m-0.5m (in Macro mode)
LCD monitor	2.5" LTPS color LCD
Flash mode	AUTO FLASH, FORCED FLASH, RED EYE, NO FLASH
Self-timer	3-second delay, 10-second delay
Exposure compensation	-2.0EV- +2.0EV (in 0.3EV increments)
White balance	AUTO, DAYLIGHT, CLOUDY, SUNSET, TUNGSTEN, FLUORESCENT
ISO sensitivity	AUTO, 50, 100, 200
Interface	DC-IN 5V terminal (Via conversion adapter) A/V OUT terminal (Via conversion adapter) USB port
Power	Rechargeable lithium-ion battery (650mAh) AC adapter/charger (5V)
Operating conditions	Operating temperature: -5°C to +40°C Storage temperature: -20°C to +60°C
Dimension (WxHxD)	Approx. 88.5 x 54.5 x 24 mm (without protruding parts)
Weight	Approx. 130g (without the battery and SD card)

* Design and specifications are subject to change without notice.

TROUBLESHOOTING



Refer to the symptoms and measures listed below before sending the camera for repairs. If the problem persists, contact your local reseller or service center.

Power Supply

Symptom	Cause	Measure
The power does not come on.	The battery is not loaded.	Load the battery correctly.
	The battery is exhausted.	Recharge or use the AC power adapter.
	The AC power adapter is not connected correctly.	Reconnect it properly.
The power cuts out during use.	The camera was left unattended and unused, so the auto power off cuts it off.	Turn the power back on.
	The battery is exhausted.	Recharge or use the AC power adapter.
The power does not go off.	Camera malfunction.	Reload the battery. If using the AC power adapter, reconnect it.
The battery runs out quickly.	It is being used in extreme low temperature.	
	Many shots are being captured in dark places inside, requiring flash.	
	The battery is not fully charged. The battery is not used for an extended period of time after charged.	Fully charge the battery and discharge it for at least one complete cycle before use to maximize its performance and lifetime.
The battery or camera feels warm.	Long period of continuous use of the camera or the flash.	

Shooting

Symptom	Cause	Measure
Even if I press the shutter button, the camera does not shoot.	The battery is running low.	Recharge or use the AC power adapter.
	The power is not on.	Turn the power on.
	The camera is not in shooting mode.	Slide the mode switch to shooting mode.
	The shutter button is not pressed all the way.	Press the shutter button all the way.
	The internal memory or memory card does not have any free space.	Load a new card, or delete unwanted files.
	End of memory card life.	Load a new memory card.
	The flash is recharging.	Wait until the flash mode icon indicated on the screen stops flashing.
	The memory card is unrecognized by the camera.	Format the memory card in this camera before its first use or when it was used other than this camera.
	The auto power off function is activated.	Turn the power on again.
Images do not appear on the LCD monitor.	The power is not on.	Turn the power on.
	The LCD monitor is dark.	Adjust the brightness of the LCD monitor in the shooting menu.
	The LCD monitor is not on.	Press the [I/O] button and switch display.
Although it is set to Auto Focus, it does not focus.	The lens or Self-timer LED is dirty.	Wipe clean with a soft, dry cloth or lens paper.
	The distance to the subject is smaller than the effective range.	Get your subject within the effective focus range.

Symptom	Cause	Measure
The flash does not fire.	The camera is set to  /  /  mode.	Switch the camera mode.
The flash cannot recharge.	The flash is set to no flash.	Set the flash to something other than no flash mode.
Even though the flash fired, the image is dark.	The distance to the subject is greater than flash effective range.	Get closer to your subject and shoot.
The image is too dark.	The image was captured in a dark place while set to no flash.	Set the flash to something other than no flash mode.
	It is under-exposed.	Set the exposure compensation to a larger value.
The image is too bright.	It is over-exposed.	Set the exposure compensation to a smaller value.
The image lacks natural color.	The image was captured in conditions that are hard for Auto White Balance to adjust to.	Add a white object to the composition.

Playback

Symptom	Cause	Measure
Cannot playback.	It is not set to playback mode.	Slide the mode switch to playback mode.
The contents of memory card cannot be replayed.	You played back a memory card that was not formatted by this device.	Loaded a card that was formatted and stored on by this device.
Files cannot be deleted.	The file is protected.	Cancel protection.
	You played back a memory card that was not formatted by this device.	Loaded a card that was formatted and stored on by this device.
Cannot format a memory card.	The memory card is write-protected.	Remove the write-protection.
	End of memory card life.	Load a new memory card.
The playback image is dark though I used the flash.	The LCD monitor is too dark.	Adjust the brightness of LCD monitor.

Other Problems

Symptom	Cause	Measure
Cannot load the memory card.	The card is facing the wrong way.	Load correctly.
Even when the camera's buttons are pressed, it does not operate.	The battery is running low.	Recharge or use the AC power adapter.
	Camera malfunction.	Turn the power off and remove the battery once, and try again.
The date and time is wrong.	The correct date and time is not set.	Set the correct date and time.
The date set has disappeared.	The battery is removed with the power still on.	Set the date and time again.

About connecting to your computer/software

Symptom	Cause	Measure
Cannot download images.	The free space on the hard disk in your computer may be insufficient.	Check whether the hard disk has a space for running Windows, and if the drive for loading image files has a capacity at least that of the memory card inserted in the camera.
	No power supply.	Recharge the battery or use the AC power adapter or turn the power on.
	The USB driver is not installed (for Windows 98/98SE).	Install USB driver.