



# **BOTTOM FREEZER REFRIGERATOR**

## User's Guide

Please read this guide thoroughly before operating and keep it handy for reference at all times.

### Models

LRBN2251#\*\* LRBN2252#\*\* LRBN2251#\*\*  
LRBN2051#\*\* LRBN2052#\*\* LRBN2271#\*\*

## TABLE OF CONTENTS

<b>English Version</b>	<b>2</b>		
<b>Versión en Español</b>	<b>27</b>	Optibin Crispers	15
<b>Versión Française</b>	<b>49</b>	Crisper Cover with Lattice on inner Surface	16
Warranty (U.S.A)	3	Door Racks	16
Warranty (CANADA)	4	Design-A-Door	16
Safety Instructions	5 - 6	Dairy Bin	17
Grounding Requirements	7	Freezer Wire Door Racks	17
Parts and Features	7	Ice Bin	17
Refrigerator Installation	8 - 11	Wire Durabase	17
Unpacking Your Refrigerator	8	Wire Basket	17
Installation	8	Wire Basket Divider	17
Base Grille	8	Drawer Tray	18
Removing, Reversing and Replacing Your Refrigerator Doors	9 - 10	Triple Twist Ice Tray	18
Door Closing and Alignment	11	Care and Cleaning	19 - 20
Using Your Refrigerator	12 - 19	General Cleaning Tips	19
Ensuring Proper Air Circulation	12	Outside	19
Multi Flow	12	Inside Walls	19
Setting the Controls	12	Door Liner and Gaskets	19
Adjusting Control Settings	13	Plastic Parts	19
Food Storage Guide	13	Condenser Coils	19
Storing Frozen Food	14	Light Bulb Replacement	19 - 20
Refrigerator Shelves	14	Power Interruptions	20
Snack Pan	15	When you go on vacation	20
Crisper Humidity Control	15	Troubleshooting Guide	21 - 24

## LIMITED WARRANTY United States of America

LG Electronics will repair or at its option replace, without charge, your product which proves to be defective in material or workmanship under normal use during the warranty period listed below from the date of original purchase.

This warranty is good only to the original purchaser of the product during the warranty period as long as it is in the U.S. including Alaska, Hawaii, and U.S. Territories.

### LG Refrigerator / Freezer Warranty Period

<u>Product</u>	<u>Parts</u>	<u>Labor</u>
Refrigerator/Freezer	1 year	1 year [In-Home Service (Except Model Gr051)]
Sealed System (Compressor, Condenser, Evaporator)	7 years	1 year [In-Home Service (Except Model Gr051)]

No other express warranty is applicable to this product. THE DURATION OF ANY IMPLIED WARRANTIES, INCLUDING THE IMPLIED WARRANTY OF MERCHANTABILITY, IS LIMITED TO THE DURATION OF THE EXPRESS WARRANTY HEREIN. LG ELECTRONICS SHALL NOT BE LIABLE FOR THE LOSS OF USE OF THE PRODUCT, INCONVIENCE, LOSS OR ANY OTHER DAMAGES, DIRECT OR CONSEQUENTIAL, ARISING OUT OF THE USE OF OR INABILITY TO USE, THIS PRODUCT OR FOR ANY BREACH OF ANY EXPRESS OR IMPLIED WARRANTY, INCLUDING THE IMPLIED WARRANTY OF MERCHANTABILITY APPLICABLE TO THIS PRODUCT.

Some States do not allow the exclusion or limitation of incidental or consequential damages or limitations on how long an implied warranty lasts; so these limitations or exclusions may not apply to you. This warranty gives you specific legal rights and you may also have other rights which vary from state to state.

### THE ABOVE WARRANTY DOES NOT APPLY TO:

1. Service trips to your home to deliver and pickup, install, instruct, or replace house fuses or correct house wiring or plumbing, or correction of unauthorized repairs.
2. Damage to the product caused by accident, pests, fire, floods, or acts of God.
3. Repairs when your LG product is used in other than normal, single-family household use.
4. Damage resulting from accident, alteration, misuse, abuse, or improper installation.

Therefore, these costs are paid by the consumer.

If the product is installed outside the normal service area, any cost of transportation involved in the repair of the product or the replacement of defective parts, shall be borne by the owner.

### CUSTOMER ASSISTANCE NUMBERS:

**To obtain Warranty Coverage:**

**Retain your Bill of Sale to prove date of purchase.**

A Copy of your Sales Receipt must be submitted at the time warranty service is provided.

**To obtain Product or Customer Service Assistance:**

**Call 1-800-243-0000** (Mon.~ Fri. 7AM ~ 8PM CT)  
(Sat. 8AM ~ 5PM CT)

Press the appropriate menu option, and have your product type (Refrigerator), model number, serial number, and ZIP/Postal Code ready.

**To obtain the nearest Authorized Service Center:**

**Call 1-800-243-0000** (24 hrs a day, 7 days per week)  
Press the appropriate option, and have your product type (Refrigerator), model number, serial number, and ZIP/Postal Code ready.

## LIMITED WARRANTY (CANADA) LG REFRIGERATOR

LG Electronics will repair or at its option replace, without charge, your product which proves to be defective in material or workmanship under normal use, during the warranty period listed below from the date of original purchase. **This warranty is good only to the original purchaser of the product during the warranty period as long as it is in any Canadian Province.**

### WARRANTY PERIOD

**LABOR:** 2 Years

**PARTS:** 2 Years

**SERIAL NUMBER:** \_\_\_\_\_

**SEALED SYSTEM:** 5 Years (Compressor, condenser, and evaporator)

**HOW SERVICE IS HANDLED:** Call **1-888-542-2623** (1-888-LG-CANADA) and choose the appropriate prompt. Please have product type (refrigerator) and ZIP Code ready.  
See our website at <http://www.lg.ca>  
This warranty provides in-home service.

No other express warranty is applicable to this product. **THE DURATION OF ANY IMPLIED WARRANTIES, INCLUDING THE IMPLIED WARRANTY OF MERCHANTABILITY, IS LIMITED TO THE DURATION OF THE EXPRESS WARRANTY HEREIN. LG ELECTRONICS USA, INC. SHALL NOT BE LIABLE FOR THE LOSS OF THE USE OF THE PRODUCT, INCONVENIENCE, LOSS OR ANY OTHER DAMAGES, DIRECT OR CONSEQUENTIAL, ARISING OUT OF THE USE OF, OR INABILITY TO USE, THIS PRODUCT OR FOR ANY BREACH OF ANY EXPRESS OR IMPLIED WARRANTY, INCLUDING THE IMPLIED WARRANTY OF MERCHANTABILITY APPLICABLE TO THIS PRODUCT.**

Some provinces do not allow the exclusion or limitation of incidental or consequential damages or limitations on how long an implied warranty lasts; so these limitations or exclusions may not apply to you. This warranty gives you specific legal rights and you may also have other rights which vary from province to province.

### THE ABOVE WARRANTY DOES NOT APPLY TO:

1. Service trips to your home to deliver and pickup, install, instruct, or replace house fuses or correct wiring, plumbing, or correction of unauthorized repairs.
2. Damage to the product caused by accident, vermin, fire, flood, alteration, misuse, abuse, improper installation, or acts of God.
3. Commercial use or use for other than the intended purpose.

**Therefore, these costs are the responsibility of the consumer.**

### CUSTOMER ASSISTANCE NUMBERS:

**To Prove Warranty Coverage:**

**a**

**Retain your Sales Receipt to prove date of purchase.**

A copy of your Sales Receipt must be submitted at the time warranty service is provided.

**To Obtain Product, Customer, or Service Assistance by phone:**

Call **1-888-542-2623** (1-888-LG-CANADA) and choose the appropriate prompt. **t**

**or by Internet:**

<http://www.lg.ca>

**To Obtain Nearest Authorized Service Center, Parts Distributor, or Sales Center by phone:**

Call **1-888-542-2623** (1-888-LG-CANADA) and choose the appropriate prompt. Please have your product type (refrigerator) and ZIP Code ready.

**or by Internet:**

<http://www.lg.ca>

# IMPORTANT SAFETY INSTRUCTIONS

## SAFETY MESSAGES

This guide contains many important safety messages. Always **read and obey** all safety messages.



This is the safety alert symbol. It alerts you to safety messages that inform you of hazards that can kill or hurt you or others, or cause damage to the product.

All safety messages will be preceded by the safety alert symbol and the hazard signal word DANGER, WARNING, CAUTION. These words mean:



**DANGER**

You **will be** killed or seriously injured if you don't follow instructions



**WARNING**

You **can** be killed or seriously injured if you don't follow instructions.



**CAUTION**

Indicates an imminently hazardous situation which, if not avoided, **may** result in minor or moderate injury, or product damage only.

All safety messages will identify the hazard, tell you how to reduce the chance of injury and tell you what can happen if the instructions are not followed.

## **WARNING**

**To reduce the risk of fire, electric shock, or injury to persons when using your product, basic safety precautions should be followed, including the following:**

- NEVER unplug your refrigerator by pulling on the power cord. Always grip the plug firmly and pull it straight out from the outlet.
- Repair or replace immediately all electric service cords that have become frayed or otherwise damaged. Do not use a cord that shows cracks or abrasion damage along its length or at either the plug or connector end.
- When moving your refrigerator away from the wall, be careful not to roll over or damage the power cord.
- DO NOT store or use gasoline or other flammable vapors and liquids in the vicinity of this or any other appliance.
- DO NOT allow children to climb, stand or hang on the refrigerator doors or shelves in the refrigerator. They could damage the refrigerator and seriously injure themselves.
- Keep fingers out of "pinch point" areas; clearances between the doors and cabinet are necessarily small. Be careful when you open the doors when children are in the area.
- Unplug your refrigerator before cleaning or making any repairs. **NOTE:** We strongly recommend that any servicing be performed by a qualified individual.
- Before replacing a burned-out light bulb, **unplug** the refrigerator or turn off power at the circuit breaker or fuse box in order to avoid contact with a live wire filament. (A burned-out light bulb may break when being replaced.) **NOTE:** Setting either or both controls to the OFF position does not remove power to the light circuit.
- For personal safety, this appliance must be properly grounded. Have the wall outlet and the circuit checked by a qualified electrician to make sure the outlet is properly grounded.
- Read all instructions before using this appliance. Use this appliance only for its intended purpose as described in this use and care guide.
- After your refrigerator is in operation, do not touch the cold surfaces in the freezer compartment when hands are damp or wet. Skin may adhere to the extremely cold surfaces.
- In refrigerators with automatic icemakers, avoid contact with the moving parts of the ejector mechanism, or with the heating element that releases the cubes. **DO NOT** place fingers or hands on the automatic icemaking mechanism while the refrigerator is plugged in.
- DO NOT refreeze frozen foods which have thawed completely. The United States Department of Agriculture in Home and Garden Bulletin No. 69 says:  
"...You may safely refreeze frozen foods that have thawed if they still contain ice crystals or if they are still cold below 40°F (4°C)."  
"...Thawed ground meats, poultry, or fish that have any off-odor or off-color should not be refrozen and should not be eaten. Thawed ice cream should be discarded. If the odor or color of any food is poor or questionable, get rid of it. The food may be dangerous to eat."  
"Even partial thawing and refreezing reduces the eating quality of foods, particularly fruits, vegetables and prepared foods. The eating quality of red meats is affected less than that of many other foods. Use refrozen foods as soon as possible to save as much of their quality as you can."

## SAVE THESE INSTRUCTIONS

## **⚠ DANGER: RISK OF CHILD ENTRAPMENT**

Child entrapment and suffocation are not problems of the past. Junked or abandoned refrigerators are still dangerous... even if they will sit for "just a few days". If you are getting rid of your old refrigerator, please follow the instructions at right to help prevent accidents.

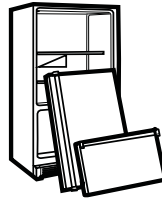

### **BEFORE YOU THROW AWAY YOUR OLD REFRIGERATOR OR FREEZER**

- Take off the doors.
- Leave the shelves in place so that children may not easily climb inside.

## **CFC DISPOSAL**

Your old refrigerator may have a cooling system that used CFCs (chlorofluorocarbons). CFCs are believed to harm stratospheric ozone.

If you are throwing away your old refrigerator, make sure the CFC refrigerant is removed for proper disposal by a qualified servicer. If you intentionally release this CFC refrigerant, you can be subject to fines and imprisonment under provisions of environmental legislation.

## **GROUNDING REQUIREMENTS**

**IMPORTANT:** Please read carefully.

### **TO CONNECT ELECTRICITY**

#### **⚠ WARNING**

##### **Electrical Shock Hazard**

**FOR PERSONAL SAFETY**, this appliance must be properly grounded. Have the wall outlet and the circuit checked by a qualified electrician to make sure the outlet is properly grounded.

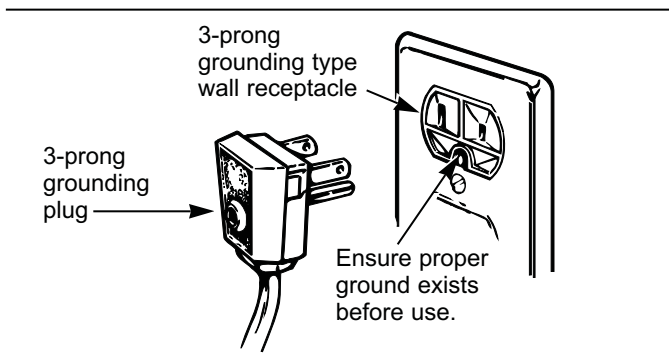

### **RECOMMENDED GROUNDING METHOD**

The refrigerator should always be plugged into its own individual properly grounded electrical outlet rated for 115 Volts, 60 Hz, AC only, and fused at 15 or 20 amperes. This provides the best performance and also prevents overloading house wiring circuits which could cause a fire hazard from overheated wires. It is recommended that a

separate circuit serving only this appliance be provided. Use a receptacle which cannot be turned off with a switch or pull chain. Do not use an extension cord.

Where a standard two-prong wall outlet is encountered, it is your personal responsibility and obligation to have it replaced with a properly grounded three-prong wall outlet.

**Do not, under any circumstances, cut or remove the third (ground) prong from the power cord.**

**NOTE:** Before performing any type of installation, cleaning, or removing a light bulb, turn the control (Thermostat, Refrigerator Control or Freezer Control, depending on the model) to OFF and then disconnect the refrigerator from the electrical source. When you are finished, reconnect the refrigerator to the electrical source and reset the control (Thermostat, Refrigerator Control or Freezer Control, depending on the model) to the desired setting.

### **USE OF EXTENSION CORDS**

**Because of potential safety hazards under certain conditions, we strongly recommend against the use of an extension cord.** However, if you still elect to use an extension cord, it is absolutely necessary that it be a UL-listed (in the United States), 3-wire grounding type appliance extension cord having a grounding type plug and outlet, and that the electrical rating of the cord be 15 amperes (minimum) and 120 volts.

Use of an extension cord will increase the clearance needed for the back of the refrigerator.

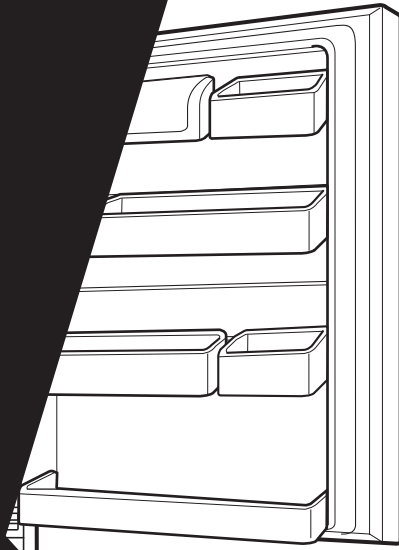

# REFRIGERATOR INSTALLATION

## **! WARNING**

### **Excessive Weight Hazard**

Use two or more people to move and install refrigerator.

Failure to do so can result in back or other injury.

## **UNPACKING YOUR REFRIGERATOR**

Remove tape and any temporary labels from your refrigerator before using. Do not remove any warning-type labels, the model and serial number label, or the TechSheet that is attached to back wall of the refrigerator.

To remove any remaining tape or glue, rub the area briskly with your thumb. Tape or glue residue can also be easily removed by rubbing a small amount of liquid dish soap over the adhesive with your fingers. Wipe with warm water and dry.

Do not use sharp instruments, rubbing alcohol, flammable fluids or abrasive cleaners to remove tape or glue. These products can damage the surface of your refrigerator. For more information, see the **Important Safety Instructions** section.

Refrigerator shelves are installed in the shipping position.

Please reinstall shelves according to your individual storage needs.

### **When Moving Your Refrigerator:**

Your refrigerator is heavy. When moving the refrigerator for cleaning or service, be sure to protect the floor. Always pull the refrigerator straight out when moving it. Do not wiggle or walk the refrigerator when trying to move it, as floor damage could occur.

## **! WARNING**





### **Explosion Hazard**

Keep flammable materials and vapors, such as gasoline, away from refrigerator.

Failure to do so can result in death, explosion or fire.

## **INSTALLATION**

1. Avoid placing the unit near heat sources, direct sunlight, or moisture.
2. To avoid vibration, the unit must be level. If required, adjust the leveling screws to compensate for unevenness of the floor. The front should be slightly higher than the rear to aid in door closing. Leveling screws can be turned easily by tipping the cabinet slightly. Turn the leveling screws clockwise (  ) to raise the unit, counterclockwise (  ) to lower it.
3. Install this appliance in an area where the temperature is between 55°F (13°C) and 110°F (43°C.) If the temperature around the appliance is too low or high, cooling ability may be adversely affected.

## **NEXT**

1. Clean your refrigerator thoroughly and wipe off all dust accumulated during shipping.
2. Install accessories such as ice cube bin, drawers, shelves, etc., in their proper places. They are packed together to prevent possible damage during shipment.
3. Let your refrigerator run for 2 or 3 hours before putting food in it. Check the flow of cold air in the freezer compartment to ensure proper cooling. Your refrigerator is now ready for use.

## **CAUTION:**

- Be careful when you work with hinge, base grille, stopper etc. You may be injured.
- Do not put hands or metal sticks into air vents, base grille or bottom of refrigerator. You may be injured or receive an electrical shock.

## **BASE GRILLE**

### **To remove the base grille:**

1. Grasp the grille with both hands.
2. Pull the grille toward yourself.

### **To install the base grille:**

1. Place clips in openings in the metal panel.
2. Push the grille toward the refrigerator until it snaps into place.

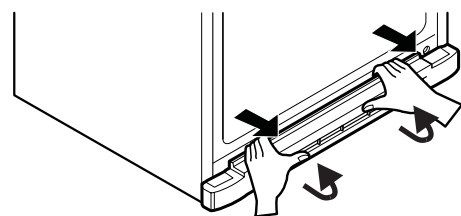





## REMOVING, REVERSING AND REPLACING REFRIGERATOR DOORS

**TOOLS NEEDED:** 10mm hex-head socket wrench, No. 2 Phillips screwdriver, flat-head screwdriver, 10mm open-end wrench, flat 2-inch putty knife.

**IMPORTANT:** Before you begin, turn the refrigerator OFF and unplug it. Remove food and any adjustable door or utility bins from doors.

### HOW TO REVERSE DOOR OPENING DIRECTION (when converting from the left-opening type to right-opening type)

#### 1. Removing Refrigerator Door

- Remove the top hinge cover (1).
- Remove the 3 screws and lift off the top hinge (2).
- Lift the Refrigerator door (3) slightly and remove it.
- Pry off the cover (4) using a slotted screwdriver and attach it on the right.
- Loosen the screw (5), remove the stoppers (6) and attach them on the left (on the opposite side).
- Loosen the pin (8) and remove it.
- Lift off the washer (9).
- Pry off the cover (7) using a slotted screwdriver and attach it on the right.

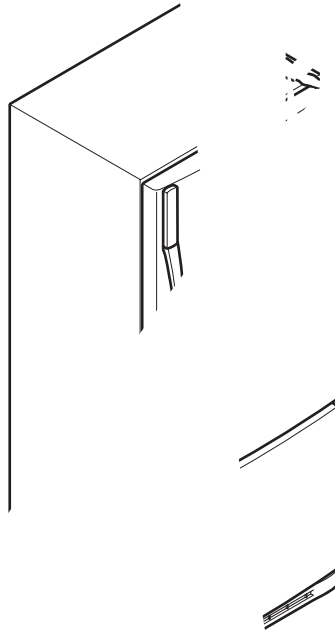

#### 2. Removing Freezer Door

Lift the door (10) slightly and remove it.

Loosen the 2 screws (11), the 2 screws (12), and the middle hinge (13).

Lift off the base grille (14).

Remove the cap (15) and attach it on the right.

Loosen the screws (16), remove the stoppers (17) and attach them on the right.



Loosen the screw (18) and attach the stopper (19) on the left side.

#### 3. Removing Door Handle

Loosen the screw (1) and the 2 caps (2) using a screwdriver. Never save the caps.

Lift the upper cover (3) upward and take it off.

Lift the lower cover (4) downward and take it off.

Loosen the 2 screws (5), take off the handle (6), and attach it on the right.

Attach the upper cover (3) by pushing it down.

Attach the lower cover (4) by pushing it up.

Attach the removed the cap (1) and the 2 caps on the left.

...res (1) and

### Freezer Door

grille (1).

(3) onto the bottom hinge pin.

the hinge (4) on the opposite side with the  
screws (9).

### Refrigerator Door

Pin (6) on the middle hinge pin (7).

Insert (8) so that it fits onto the middle hinge  
pin.

Insert hinge (10) with serews.

Reinstall hinge cover (11).

### After Closing the Door

Make sure the four corners of the door gasket are  
not folded. To ensure a good seal, apply a small  
amount of grease on the gasket.

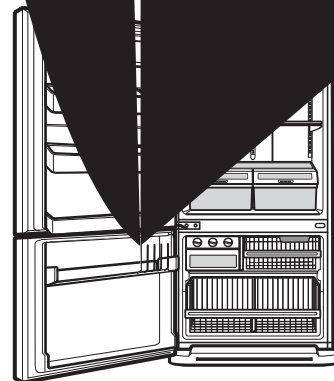



# USING YOUR REFRIGERATOR

## ENSURING PROPER AIR CIRCULATION

In order to ensure proper temperatures, air must flow between the refrigerator and freezer sections. As shown in the illustration below, cool air enters through the bottom of the freezer section and moves up. Most of the air then flows through the freezer section vents and recirculates under the freezer floor. The rest of the air enters the refrigerator section through the top vent.

## MULTI FLOW

- The cooling fan operates more powerful and effective than in normal operation. This is specially noticeable when new food is placed in the refrigerator compartment.
- If water or foreign substances enter the cool air vent while cleaning, efficiency will be lowered. In addition, if gasket is damaged, efficiency may be lowered because of escaping cool air.

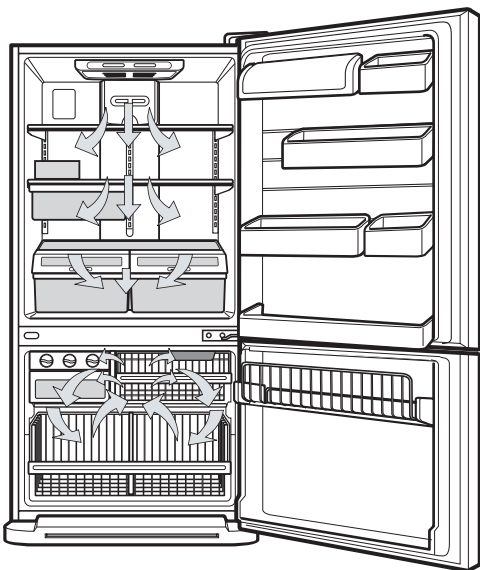

**Do not block any of these vents** with food packages. If the vents are blocked, airflow will be interrupted and temperature and moisture problems may occur.

**IMPORTANT:** Because air circulates between both sections, any odors formed in one section will transfer to the other. You must thoroughly clean both sections to eliminate odors. To prevent odor transfer and drying out of food, wrap or cover foods tightly. (See the **Food Storage Guide** section for details.)

## SETTING THE CONTROLS

- Your refrigerator has two controls that let you regulate the temperature in the freezer and refrigerator compartments.
- Initially set the REFRIGERATOR CONTROL at 37°F (3°C) and the FREEZER CONTROL at 0°F (-18°C). Leave it at this setting for 24 hours (one day) to stabilize. Then adjust the compartment temperature as desired.

### ► Better / Good model

**Refrigerator control: Position 1 to 7 (32°F to 47°F or 0°C to 8°C)**

The lower the number setting, the colder the refrigerator compartment will become.



- **Freezer control: Position 1 to 7 (-6°F to 8°F to -21°C to -13°C)**

When the setting is at a lower number, the freezer compartment becomes colder. But the refrigerator compartment becomes warmer because less cold air flows into the refrigerator.

### Express Freezing

Press the Express Freezing key and the LED will turn on. This function will remain activated for 24 hours and intensify the cooling speed of freezer and increase the amount of ice.

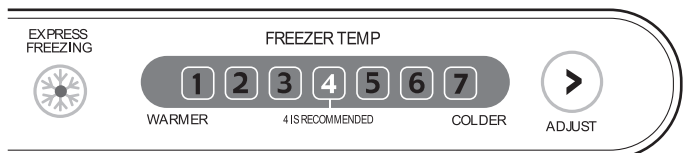

# USING YOUR REFRIGERATOR

## ADJUSTING CONTROL SETTINGS

Give the refrigerator time to cool down completely before adding food. It is best to wait 24 hours before you put food into the refrigerator. The mid-settings indicated in the previous section should be correct for normal household refrigerator usage. The controls are set correctly when milk or juice is as cold as you like and when ice cream is firm.

The refrigerator control functions as the thermostat for the entire appliance (refrigerator and freezer sections.) The higher the number setting, the longer the compressor will run to keep the temperature colder. The freezer control adjusts the cold air flow from the freezer to the refrigerator. Setting the freezer control to a lower temperature keeps more cold air in the Freezer compartment to make it colder.

If you need to adjust temperatures in the refrigerator or freezer, start by adjusting the refrigerator first. Wait 24 hours after the refrigerator adjustment to check the freezer temperature. If it is too warm or too cold, then adjust the freezer control as well.

Use the settings listed in the chart below as a guide. **Always remember to wait at least 24 hours between adjustments.**

<b>CONDITION/REASON:</b>	<b>RECOMMENDED ADJUSTMENT:</b>
<b>REFRIGERATOR section too warm</b> <ul style="list-style-type: none"><li>• Door opened often</li><li>• Large amount of food added</li><li>• Room temperature very warm</li></ul>	Turn <b>REFRIGERATOR control to next higher number, wait 24 hours, then re-check</b>
<b>FREEZER section too warm/ ice not made fast enough</b> <ul style="list-style-type: none"><li>• Door opened often</li><li>• Large amount of food added</li><li>• Very cold room temperature (can't cycle often enough)</li><li>• Heavy ice usage</li><li>• Air vents blocked by items</li></ul>	Turn <b>FREEZER control to next higher number, wait 24 hours, Then re-check</b>
<b>REFRIGERATOR section too cold</b> <ul style="list-style-type: none"><li>• Controls not set correctly for your conditions</li></ul>	Move items out of airstream Turn <b>REFRIGERATOR control to next lower number, wait 24 hours, then re-check</b>
<b>FREEZER section too cold</b> <ul style="list-style-type: none"><li>• Controls not set correctly for your conditions</li></ul>	Turn <b>FREEZER control to next lower number, wait 24 hours, then re-check</b>

## FOOD STORAGE GUIDE

### Storing Fresh Food

Wrap or store food in the refrigerator in airtight and moisture-proof material unless otherwise noted. This prevents food odor and taste transfer throughout the refrigerator. For dated products, check date code to ensure freshness.

### Butter or margarine

Keep opened butter in a covered dish or closed compartment. When storing an extra supply, wrap in freezer packaging and freeze.

### Cheese

Store in the original wrapping until you are ready to use it. Once opened, rewrap tightly in plastic wrap or aluminum foil.

### Milk

Wipe milk cartons. For best storage, place milk on interior shelf, not on door shelf.

### Eggs

Store in original carton on interior shelf, not on door shelf.

### Fruit

Wash, let dry, and store in refrigerator in plastic bags or in the crisper. Do not wash or hull berries until you are ready to use them. Sort and keep berries in their original container in a crisper, or store in a loosely closed paper bag on a refrigerator shelf.

### Leafy vegetables

Remove store wrapping and trim or tear off bruised and discolored areas. Wash in cold water and drain. Place in a plastic bag or plastic container and store in the crisper.

### Vegetables with skins (carrots, peppers)

Place in plastic bags or plastic container and store in crisper.

### Fish

Use fresh fish and shellfish the same day purchased.

### Snack Pan

Store most chef fresh in original wrapping as long as it is airtight and moisture-proof. Rewrap if necessary.

### Leftovers

Cover leftovers with plastic wrap or aluminum foil. Plastic containers with tight lids can also be used.

# USING YOUR REFRIGERATOR

## STORING FROZEN FOOD

**NOTE:** For further information about preparing food for freezing or food storage times, check a freezer guide or a reliable cookbook.

### Packaging

Successful freezing depends on correct packaging. When you close and seal the package, it must not allow air or moisture in or out. If you do, you could have food odor and taste transfer throughout the refrigerator and also dry out frozen food.

### Packaging recommendations:

- Rigid plastic containers with tight-fitting lids
- Straight-sided canning/freezing jars
- Heavy-duty aluminum foil
- Plastic-coated paper
- Non-permeable plastic wraps
- Specified freezer-grade self-sealing plastic bags

Follow package or container instructions for proper freezing methods.

### Do not use:

- Bread wrappers
- Non-polyethylene plastic containers
- Containers without tight lids
- Wax paper or wax-coated freezer wrap
- Thin, semi-permeable wrap

### Freezing

Your freezer will not quick-freeze any large quantity of food. Do not put more unfrozen food into the freezer than will freeze within 24 hours (no more than 2 to 3 lbs of food per cubic foot of freezer space). Leave enough space in the freezer for air to circulate around packages. Be careful to leave enough room at the front so the door can close tightly.

Storage times will vary according to the quality and type of food, the type of packaging or wrap used (airtight and moisture-proof) and the storage temperature. Ice crystals inside a sealed package are normal. This simply means that moisture in the food and air inside the package have condensed, creating ice crystals.

**NOTE:** Allow hot foods to cool at room temperature for 30 minutes, then package and freeze. Cooling hot foods before freezing saves energy.

**NOTE:** Do not store food near the sensor; it may cause the sensor to malfunction.

## ⚠ WARNING

### Suffocation Hazard

When using dry ice, provide adequate ventilation. Dry ice is frozen carbon dioxide (**CO<sub>2</sub>**). When it vaporizes, it can displace oxygen, causing dizziness, light-headedness, unconsciousness and death by suffocation. Open a window and do not breathe the vapors.

## REFRIGERATOR SHELVES

The shelves in your refrigerator are adjustable to meet your individual storage needs. These units are all glass shelves.

Storing similar food items together in your refrigerator and adjusting the shelves to fit different heights of items will make finding the exact item you want easier; it will also reduce the amount of time the refrigerator door is open, saving energy.

**IMPORTANT:** Do not clean glass shelves with warm water when they are cold. Shelves may break if exposed to sudden temperature changes or impact, such as bumping. For your protection, glass shelves are made with tempered glass, which will shatter into small pebble-sized pieces.

**NOTE:** Glass shelves are heavy. Use special care when removing them to avoid dropping them.

### Adjusting Shelves

Remove shelves from the shipping position and replace shelves in the position you want.

- **To remove a shelf** : Tilt up the front of the shelf in the direction of (1) and lift it in the direction of (2). Pull the shelf out.
- **To replace a shelf** : Tilt the front of the shelf up and guide the shelf hooks into the slots at a desired height. Then lower the front of the shelf so that the hooks drop into the slots.

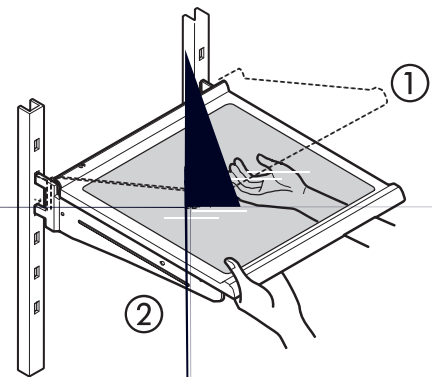

**NOTE:** Make sure that shelves are leveled from one side to the other. Failure to do so may result in the shelf falling or spilling food.



# USING YOUR REFRIGERATOR

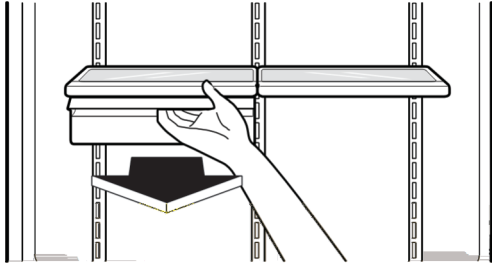

## SNACK PAN

While holding the chef fresh with one hand, pull it forward slightly. Lift slightly and pull it out.



## CRISPER HUMIDITY CONTROL

You can control the amount of humidity in the moisture-sealed crispers. Adjust the control to any setting between  and .

-  lets moist air out of the crisper for best storage of fruits.
-  keeps moist air in the crisper for best storage of fresh, leafy vegetables.

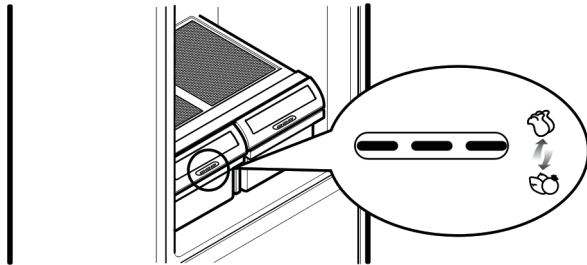

## OPTIBIN CRISPERS

The OptiBin Crispers provide fresher-tasting fruit and vegetables by letting you easily control humidity inside the crisper. The OptiBin Crispers include: 1) a humidity control knob at the front of the crisper cover and 2) a large lattice on the inner surface of the cover to hold or release moisture.

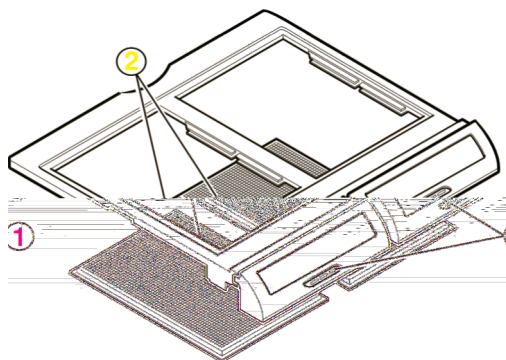

You can store small vegetables or fruits requiring more or less humidity in separate drawers.

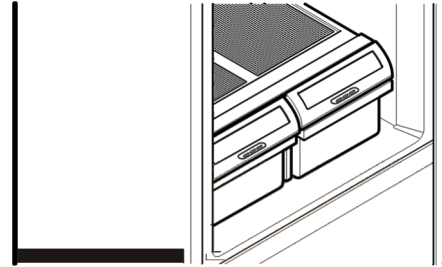

### To remove the crisper door flap:

1. Raise the door as high as it will open.
2. Using your finger, press the plastic hinge toward the center of the door flap.
3. Lift the door out of its place.
4. Replacement is the opposite of removal.

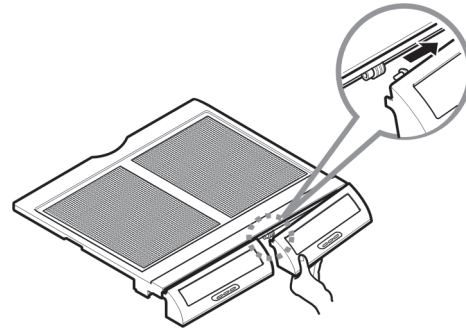

### To remove the glass:

1. Lift up the glass after inserting a screwdriver under the crisper cover.
2. Pull up and out.

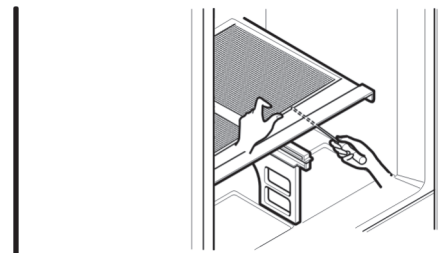

### To remove the crisper:

1. Slide crisper straight out to the stop.
2. Lift the front of the crisper, then pull it out to remove.
3. **Replace the crisper** by sliding it back in fully past the drawer stop.

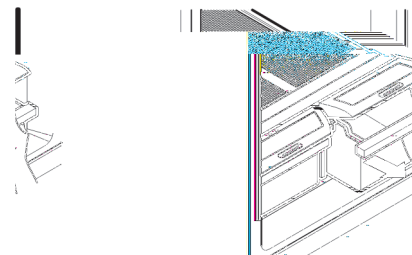

# USING YOUR REFRIGERATOR

## CRISPER COVER WITH LATTICE ON INNER SURFACE

To remove the crisper cover:

1. Remove both crisper drawers.
2. While holding the crisper cover support (2), pull the cover up and out(1).

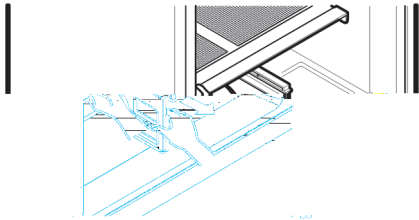

**WARNING:** Be careful when handling glass cover since glass is not attached to cover.

To remove the lattice on inner surface:

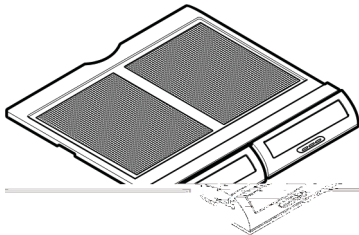

1. Remove crisper cover(as illustrated above).
2. Hold the glass cover and overturn crisper cover.
3. For each lattice hold lattice and pull sides of the cover outward to remove lattice.

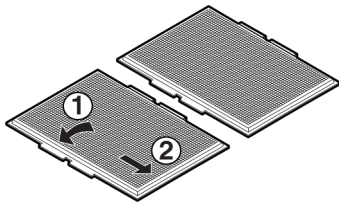

To replace lattice on inner surface:

1. For each lattice insert middle tab in 1 (closed to glass cover)and pull sides of the cover to insert lattice.

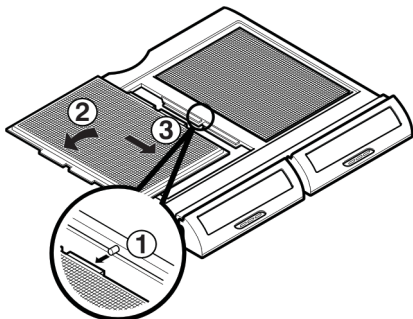

## DOOR RACKS

The door racks may be removed for easier cleaning.

### Snap-on Door Racks

To remove the racks:

1. Remove all items in the door racks.
2. Push the rack against the inside wall of the door (A) and lift up the door rack (B).

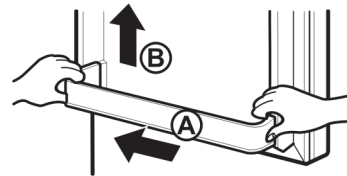

To replace the racks:

1. Hold either end of the door rack against the inside wall of the door.
2. Push down the rack until it locks in place.

## DESIGN-A-DOOR

1. Bins can be moved to either side of the door.

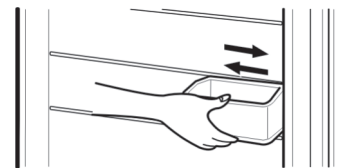

2. To remove the bin, simply lift the bin up and pull straight out.

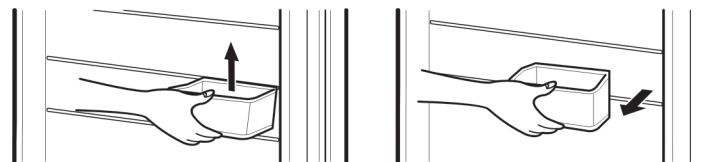

3. To replace the bin, slide it in above the desired support button and push down until it locked completely so that "tick" sounds can be heard.

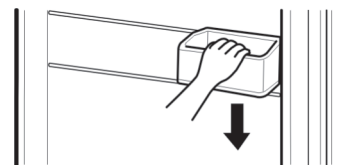

4. To move to lowest position, make sure if all bins are correctly assembled so that they don't fall out of door.

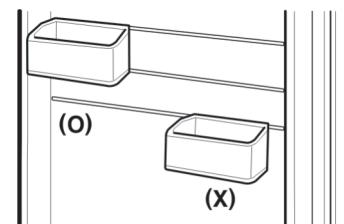

**Warning:** Somebody can be hurt if door bins are not firmly assembled.

**NOTE:** Do not adjust a bin that is loaded with food.







## CARE AND CLEANING

### ⚠ WARNING



#### Explosion Hazard

Use non-flammable cleaner.

Failure to do so can result in death, explosion, or fire.

Both the refrigerator and freezer sections defrost automatically. However, clean both sections about once a month to prevent odors. Wipe up spills immediately.

### GENERAL CLEANING TIPS

- Unplug refrigerator or disconnect power.
- Remove all removable parts, such as shelves, crispers, etc.
- Use a clean sponge or soft cloth and a mild detergent in warm water. Do not use abrasive or harsh cleaners.
- Hand wash, rinse and dry all surfaces thoroughly.
- Plug in refrigerator or reconnect power.

### OUTSIDE

Waxing external painted metal surfaces helps provide rust protection. Do not wax plastic parts. Wax painted metal surfaces at least twice a year using appliance wax (or auto paste wax). Apply wax with a clean, soft cloth.

For products with a stainless steel exterior, use a clean sponge or soft cloth and a mild detergent in warm water. Do not use abrasive or harsh cleaners. Dry thoroughly with a soft cloth.

### INSIDE WALLS (allow freezer to warm up so cloth won't stick)

To help remove odors, you can wash the inside of the refrigerator with a mixture of baking soda and warm water. Mix 2 tablespoons baking soda to 1 quart of water (26 g soda to 1 liter water.) Be sure the baking soda is completely dissolved so does it not scratch the surfaces of the refrigerator.

### DOOR LINERS AND GASKETS

Do not use cleaning waxes, concentrated detergents, bleaches, or cleaners containing petroleum plastic parts.

### PLASTIC PARTS (covers and panels)

Do not use paper towels, window sprays, abrasive cleansers, or flammable fluids. These can scratch or damage the material.

### CONDENSER COILS

Remove grille base. (See the grille base section on page 8.)

Use a vacuum cleaner with an extended attachment to clean condenser coils.

Vacuum coils when dusty or dirty. Coils may need to be cleaned as often as every other month.

Replace grille base.

### LIGHT BULB REPLACEMENT

### ⚠ WARNING

#### Electrical Shock Hazard

Before replacing a burned-out light bulb, either unplug the refrigerator or turn off power at the circuit breaker or fuse box.

**NOTE:** Moving the control to the OFF position does not remove power to the light circuit.

**NOTE:** Not all appliance bulbs will fit your refrigerator. Be sure to replace the bulb with one of the same size, shape and wattage.

#### To change the refrigerator light:

1. Unplug the power cord from the outlet.
2. Remove refrigerator shelves.
3. Release the hooks on both ends of the light shield and pull the shield down to remove it.
4. Turn the bulb counterclockwise.
5. Assembly is the reverse order of disassembly.

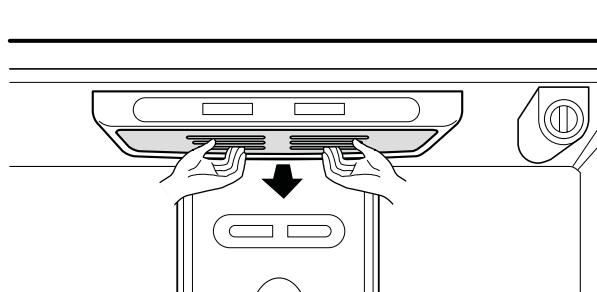

### **To change the freezer light:**

1. Unplug refrigerator or disconnect power.
2. Reach behind light shield to remove bulb.
3. Replace bulb with a 40-watt appliance bulb.
4. Plug in refrigerator or reconnect power.

## **POWER INTERRUPTIONS**

If the electricity goes off, call the power company and ask how long it will be off.

1. If the power will be out for 24 hours or less, keep both refrigerator doors closed to help foods stay cold and frozen.
2. If the power will be out for more than 24 hours:
  - a) Remove all frozen food and store it in a frozen food locker.

**OR**

- b) Place 2 lbs of dry ice in the freezer for every cubic foot of freezer space. This will keep the food frozen for two to four days. While handling dry ice, wear gloves to protect your hands from frostbite.

**OR**

- c) If neither a food locker nor dry ice is available, consume or can perishable food at once.

## **WHEN YOU GO ON VACATION**

**If you choose to leave the refrigerator on while you are away,** follow these steps to prepare your refrigerator before you leave.

1. Use up any perishables and freeze other items.
2. Empty the ice bin.

**If you choose to turn the refrigerator off before you leave,** follow these steps.

1. Remove all food from the refrigerator.
2. Depending on your model, set the thermostat control (refrigerator control) to OFF. See the **Setting the Controls** section.
3. Clean refrigerator, wipe it and dry well.
4. Tape rubber or wood blocks to the tops of both doors to prop them open far enough for air to get in. This stops odor and mold from building up.

# TROUBLESHOOTING GUIDE

## UNDERSTANDING SOUNDS YOU MAY HEAR

Your new refrigerator may make sounds that your old one didn't make. Because the sounds are new to you, you might be concerned about them. Most of the new sounds are normal. Hard surfaces, like the floor, walls and cabinets, can make the sounds seem louder than they actually are. The following describes the kinds of sounds and what may be making them.

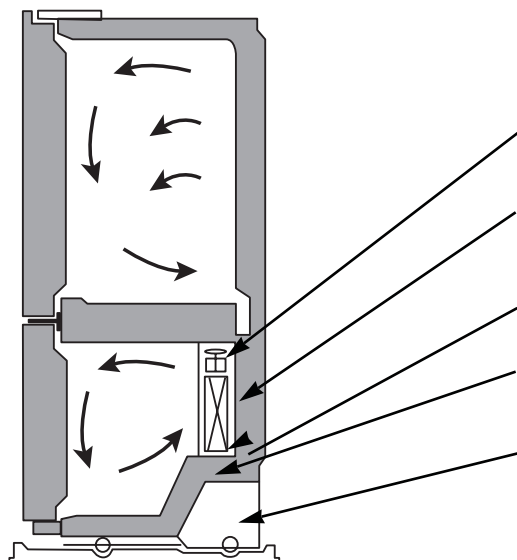

- The defrost timer will click when the automatic defrost cycle begins and ends. The thermostat control (or refrigerator control, depending on the model) will also click when cycling on and off.
- Rattling noises may come from the flow of refrigerant, the water line, or items stored on top of the refrigerator.
- Your refrigerator is designed to run more efficiently to keep your food items at the desired temperature. The high efficiency compressor may cause your new refrigerator to run longer than your old one, and you may hear a pulsating or high-pitched sound.
- You may hear the evaporator fan motor circulating the air through the refrigerator and freezer compartments.
- As each cycle ends, you may hear a gurgling sound due to the refrigerant flowing in your refrigerator.
- Contraction and expansion of the inside walls may cause a popping noise.
- Water dripping on the defrost heater during a defrost cycle may cause a sizzling sound.
- You may hear air being forced over the condenser by the condenser fan.
- You may hear water running into the drain pan during the defrost cycle.

## REFRIGERATOR DOES NOT OPERATE

Check if...	Then...
The power supply cord is unplugged.	Firmly plug the cord into a live outlet with proper voltage.
A household fuse has blown or circuit breaker tripped.	Replace the fuse or reset the circuit breaker.
The refrigerator control is set to the OFF position.	Refer to the <b>Setting the Controls</b> section on page 12.
Refrigerator is in the defrost cycle.	Wait about 30 minutes for defrost cycle to end.

## VIBRATION OR RATTLING NOISE

Check if...	Then...
The refrigerator is not resting solidly on the floor.	Floor is weak or uneven or leveling legs need adjusting. See <b>Installation</b> section on page 11.

## LIGHTS DO NOT WORK

Check if...	Then...
The power supply cord is unplugged.	Firmly plug the cord into a live outlet with proper voltage.
Light bulb is loose in the socket.	Turn the refrigerator control to the OFF position and unplug the refrigerator. Gently remove the bulb and reinsert. Then plug in refrigerator and reset the refrigerator control.
Light bulb has burned out.	Replace with an appliance bulb of the same wattage, size and shape available at your local hardware store. (See the <b>Changing the Light Bulb(s)</b> section on pages 19 - 20.) Turn the temperature control to the OFF position and unplug the refrigerator prior to replacement.

## TROUBLESHOOTING GUIDE

### COMPRESSOR MOTOR SEEMS TO RUN TOO MUCH

Check if...	Then...
The refrigerator that was replaced was an older model.	Modern refrigerators with more storage space require more operating time.
The room temperature is hotter than normal.	The motor will run longer under warm conditions. At normal room temperatures, expect your motor to run about 40% to 80% of the time. Under warmer conditions, expect it to run even more often.
The door is opened often or a large amount of food has just been added.	Adding food and opening the door warms the refrigerator. It is normal for the refrigerator to run longer in order to cool the refrigerator back down. Adding a large amount of food warms the refrigerator. See the <b>Food Storage Guide</b> section on page 13. In order to conserve energy, try to get everything you need out of the refrigerator at once, keep food organized so it is easy to find and close the door as soon as the food is removed.
The refrigerator was recently plugged in and the refrigerator control was set correctly	The refrigerator will take up to 24 hours to cool completely.
The refrigerator control was not set correctly for the surrounding conditions.	See the <b>Adjusting control settings</b> section on page 16.
The doors are not closed completely.	Push the doors firmly shut. If they will not shut all the way, see <b>Doors will not close completely</b> below.
The condenser coils are dirty.	This prevents air transfer and makes the motor work harder. Clean the condenser coils. Refer to the <b>Care and Cleaning</b> section on page 19.

### DOORS WILL NOT CLOSE COMPLETELY

Check if...	Then...
The refrigerator is not level.	See the <b>Installation</b> section on page 10 to level refrigerator.
Food packages are blocking the door open.	Rearrange food containers to clear door and door shelves.
The ice bin, crisper cover, pans, shelves, door bins or baskets are out of position.	Push bins all the way in and put crisper cover, pans, shelves and baskets into their correct positions. See the <b>Using Your Refrigerator</b> section on pages 12.
The gaskets are sticking.	Clean gaskets and the surface that they touch. Rub a thin coat of paraffin wax on the gaskets after cleaning.
The refrigerator wobbles or seems unstable.	Level the refrigerator. Refer to the <b>Door Closing and Alignment</b> section on page 11.
The doors were removed during product installation and not properly replaced.	Remove and replace the doors according to the <b>Removing, Reversing and Replacing Refrigerator Doors</b> section on pages 9 or call a qualified service technician.

### FROST OR ICE CRYSTALS ON FROZEN FOOD

Check if...	Then...
The door is not closing properly.	See <b>Doors will not close completely</b> above.
The door is opened often.	When the door is opened, warm, humid air is allowed in the freezer resulting in frost.

## TROUBLESHOOTING GUIDE

### ICE HAS OFF-TASTE OR ODOR

Check if...	Then...
The icemaker was recently installed.	Discard first few batches of ice to avoid discolored or off-flavored ice.
The ice has been stored for too long.	Throw away old ice and make new supply.
The food has not been wrapped tightly in either compartment.	Rewrap foods since odors may migrate to the ice if food is not wrapped properly.
The water supply contains minerals such as sulfur.	A filter may need to be installed to eliminate taste and odor problems.
The interior of refrigerator needs cleaning.	See <b>Care and Cleaning</b> section on page 19.
Ice storage bin needs cleaning.	Empty and wash bin. Discard old cubes.

### THERE IS WATER IN THE DEFROST DRAIN PAN

Check if...	Then...
The refrigerator is defrosting.	The water will evaporate. It is normal for water to drip into the defrost pan.
It is more humid than normal.	Expect that the water in the defrost pan will take longer to evaporate. This is normal when it is hot or humid.

### THE REFRIGERATOR SEEMS TO MAKE TOO MUCH NOISE

Check if...	Then...
The sounds may be normal for your refrigerator.	Refer to the <b>Understanding Sounds You May Hear</b> section on page 21.

### THE ICEMAKER IS NOT PRODUCING ICE OR ICE CUBES ARE FREEZING TOO SLOWLY

Check if...	Then...
The freezer temperature is cold enough to produce ice.	Wait 24 hours after hook-up for ice production. See the <b>Setting the Controls</b> section on page 12
Door left open.	Check to see if something is holding the door open.

### CUBES PRODUCED BY ICEMAKER ARE TOO SMALL

Check if...	Then...
Smaller cube size level is selected.	Select larger cube size using cube size selector.
Water shutoff valve connecting refrigerator to water line may be clogged.	Call a plumber to clear the valve.

### THE DOORS ARE DIFFICULT TO OPEN

Check if...	Then...
The gaskets are dirty or sticky.	Clean gaskets and the surfaces that they touch. Rub a thin coat of appliance polish or kitchen wax on the gaskets after cleaning
The door is reopened within a short time after having been opened.	When you open the door, warmer air enters the refrigerator. As the warm air cools, it can create a vacuum. If the door is hard to open, wait 5 minutes to allow the air pressure to equalize, then see if it opens more easily.

## TROUBLESHOOTING GUIDE

### TEMPERATURE IS TOO WARM OR THERE IS INTERIOR MOISTURE BUILDUP

Check if...	Then...
The air vents are blocked. Cold air circulates from the freezer to the fresh food section and back again through air vents in the wall dividing the two sections.	Locate air vents by using your hand to sense airflow and move all packages that block vents and restrict airflow. Refer to <b>multi flow</b> on page 12 for the location of air vents.
The doors are opened often.	When the door is opened, warm humid air is allowed into the refrigerator. The more the door is opened, the faster the humidity builds up, and the more warm air the refrigerator must cool. In order to keep the refrigerator cool, try to get everything you need out of the refrigerator at once, keep food organized so it is easy to find and close the door as soon as the food is removed.
The control is not set correctly for the surrounding conditions.	Refer to the <b>Setting the Controls</b> section on page 12. Wait 24 hours for temperatures to stabilize or even out. If the temperature is too cold or too warm, move the dial one number at a time.
A large amount of food has just been added to the refrigerator or freezer.	Adding food warms the refrigerator. It can take a few hours for the refrigerator to return to normal temperature.
The food is not packaged correctly.	Wrap food tightly and wipe off damp containers prior to storing in the refrigerator to avoid moisture accumulation. If necessary, repackage food according to the guidelines in the <b>Food Storage Guide</b> section on page 13.
The doors are not closing completely.	See <b>Doors will not close completely</b> on page 23
The weather is humid.	In humid weather, air carries moisture into refrigerator when doors are opened.
A self-defrost cycle was completed.	It is normal for droplets to form on the back wall after the refrigerator self-defrosts.





