

Panasonic®

WMA MP3 CD Player/Receiver
Récepteur/lecteur CD avec lecture WMA/MP3
Reproductor de CD, WMA y MP3/receptor

Model: **CQ-C3304U**



WMA MP3

- Please read these instructions (including "Limited Warranty" and "Customer Services Directory") carefully before using this product and keep this manual for future reference.
- Prière de lire attentivement ces instructions (y compris la «Garantie limitée» et le «Répertoire des services à la clientèle») avant d'utiliser ce produit et conserver ce mode d'emploi pour s'y référer ultérieurement.
- Lea estas instrucciones cuidadosamente antes de usar este producto y guarde este manual para usar como referencia futura.

Safety Information

■ Read the operating instructions for the unit and all other components of your car audio system carefully before using the system. They contain instructions about how to use the system in a safe and effective manner. Panasonic assumes no responsibility for any problems resulting from failure to observe the instructions given in this manual.

■ This manual uses pictographs to show you how to use the product safely and to alert you to potential dangers resulting from improper connections and operations. The meanings of the pictographs are explained below. It is important that you fully understand the meanings of the pictographs in order to use this manual and the system properly.



Warning

This pictograph intends to alert you to the presence of important operating instructions and installation instructions. Failure to heed the instructions may result in severe injury or death.



Caution

This pictograph intends to alert you to the presence of important operating instructions and installation instructions. Failure to heed the instructions may result in injury or material damage.

Warning

Observe the following warnings when using this unit.

- The driver should neither watch the display nor operate the system while driving.**
Watching the display or operating the system will distract the driver from looking ahead of the vehicle and can cause accidents. Always stop the vehicle in a safe location and use the parking brake before watching the display or operating the system.
- Use the proper power supply.**
This product is designed for operation with a negative grounded 12 V DC battery system. Never operate this product with other battery systems, especially a 24 V DC battery system.
- Keep batteries and insulation film out of reach of infants.**
Batteries and insulation film can be ingested, so keep them out of the reach of infants. If an infant ingests a battery or insulation film, please seek immediate medical attention.
- Protect the Deck Mechanism.**
Do not insert any foreign objects into the slot of this unit.
- Do not disassemble or modify the unit.**
Do not disassemble, modify the unit or attempt to repair the product yourself. If the product needs to be repaired, consult your dealer or an authorized Panasonic Servicenter.
- Do not use the unit when it is out of order.**
If the unit is out of order (no power, no sound) or in an abnormal state (has foreign objects in it, is exposed to water, is smoking, or smells), turn it off immediately and consult your dealer.
- The remote control unit should not lie about in the car.**
If the remote control unit lies about, it could fall on the floor while driving, get wedged under the brake pedal, and lead to a traffic accident.
- Refer fuse replacement to qualified service personnel.**
When the fuse blows out, eliminate the cause and have it replaced with the fuse prescribed for this unit by a qualified service engineer. Incorrect replacement of the fuse may lead to smoke, fire, and damage to the product.

Observe the following warnings when installing.

- Disconnect the lead from the negative (–) battery terminal before installation.**
Wiring and installation with the negative (–) battery terminal connected may cause electrical shock and injury due to a short circuit.
Some cars equipped with the electrical safety system have specific procedures of battery terminal disconnection.
FAILURE TO FOLLOW THE PROCEDURE MAY LEAD TO THE UNINTENDED ACTIVATION OF THE ELECTRICAL SAFETY SYSTEM RESULTING IN DAMAGE TO THE VEHICLE AND PERSONAL INJURY OR DEATH.
- Never use safety-related components for installation, grounding, and other such functions.**
Do not use safety-related vehicle components (fuel tank, brake, suspension, steering wheel, pedals, airbag, etc.) for wiring or fixing the product or its accessories.
- Installing the product on the air bag cover or in a location where it interferes with airbag operation is prohibited.**
- Check for piping, gasoline tank, electric wiring, and other items before installing the product.**
If you need to open a hole in the vehicle chassis to attach or wire the product, first check where the wire harness, gasoline tank, and electric wiring are located. Then open the hole from outside if possible.
- Never install the product in a location where it interferes with your field of vision.**
- Never have the power cord branched to supply other equipment with power.**
- After installation and wiring, you should check the normal operation of other electrical equipment.**
The continuation of their using in abnormal conditions may cause fire, electrical shock or a traffic accident.
- In the case of installation to an airbag equipped car, confirm warnings and cautions of the vehicle manufacturer before installation.**
- Make sure the leads do not interfere with driving or getting in and out of the vehicle.**
- Insulate all exposed wires to prevent short circuiting.**

Caution

Observe the following cautions when using this unit.

- ❑ **Keep the sound volume at an appropriate level.**
Keep the volume level low enough to be aware of road and traffic conditions while driving.
- ❑ **This unit is designed for use exclusively in automobiles.**
- ❑ **Do not operate the unit for a prolonged period with the engine turned off.**
Operating the audio system for a long period of time with the engine turned off will drain the battery.
- ❑ **Do not expose the unit to direct sunlight or excessive heat.**
Otherwise these will raise the interior temperature of the unit, and it may lead to smoke, fire, or other damage to the unit.
- ❑ **Do not use the product where it is exposed to water, moisture, or dust.**
Exposure of the unit to water, moisture, or dust may lead to smoke, fire, or other damage to the unit. Make especially sure that the unit does not get wet in car washes or on rainy days.

Observe the following cautions when installing.

- ❑ **Refer wiring and installation to qualified service personnel.**
Installation of this unit requires special skills and experience. For maximum safety, have it installed by your dealer. Panasonic is not liable for any problems resulting from your own installation of the unit.
- ❑ **Follow the instructions to install and wire the product.**
Not following the instructions to properly install and wire the product could cause an accident or fire.
- ❑ **Take care not to damage the leads.**
When wiring, take care not to damage the leads. Prevent them from getting caught in the vehicle chassis, screws, and moving parts such as seat rails. Do not scratch, pull, bend or twist the leads. Do not run them near heat sources or place heavy objects on them. If leads must be run over sharp metal edges, protect the leads by winding them with vinyl tape or similar protection.
- ❑ **Use the designated parts and tools for installation.**
Use the supplied or designated parts and appropriate tools to install the product. The use of parts other than those supplied or designated may result in internal damage to the unit. Faulty installation may lead to an accident, a malfunction or fire.
- ❑ **Do not block the air vent or the cooling plate of the unit.**
Blocking these parts will cause the interior of the unit to overheat and will result in fire or other damage.
- ❑ **Do not install the product where it is exposed to strong vibrations or is unstable.**
Avoid slanted or strongly curved surfaces for installation. If the installation is not stable, the unit may fall down while driving and this can lead to an accident or injury.

❑ **Installation Angle**

The product should be installed in a horizontal position with the front end up at a convenient angle, but not more than 30°.

The user should bear in mind that in some areas there may be restrictions on how and where this unit must be installed. Consult your dealer for further details.

- ❑ **Wear gloves for safety. Make sure that wiring is completed before installation.**
- ❑ **To prevent damage to the unit, do not connect the power connector until the whole wiring is completed.**
- ❑ **Do not connect more than one speaker to one set of speaker leads. (except for connecting to a tweeter)**

Observe the following cautions when handling the battery for the remote control unit.

- Use only specified battery (CR2025).
- Match the polarity of the battery with the (+) and (-) marks in the battery case.
- Replace a dead battery as soon as possible.
- Remove the battery from the remote control unit when not using it for an extended period of time.
- Insulate the battery (by placing them in a plastic bag or covering them with vinyl tape) before disposal or storage.
- Dispose of the battery according to the local regulations.
- Do not disassemble, recharge, heat or short the battery. Do not throw a battery into a fire or water.

In case of battery leakage

- Thoroughly wipe the battery liquid off the battery case and insert new battery.
- If any part of your body or clothing comes into contact with battery liquid, wash it with plenty of water.
- If battery liquid comes into contact with your eyes, wash them with plenty of water and get immediate medical attention.

Safety Information (continued)



Caution

THIS PRODUCT UTILIZES A CLASS I LASER.
USE OF CONTROLS OR ADJUSTMENTS OR PERFORMANCE
OF PROCEDURES OTHER THAN THOSE SPECIFIED HEREIN
MAY RESULT IN HAZARDOUS RADIATION EXPOSURE.
DO NOT OPEN COVERS AND DO NOT REPAIR YOURSELF.
REFER SERVICING TO QUALIFIED PERSONNEL.

The following applies only in the U.S.A.

Part 15 of the FCC Rules

FCC Warning:

Any unauthorized changes or modifications to this equipment would void the user's authority to operate this device.

Notice

This product contains a CR Coin Cell Lithium Battery which contains Perchlorate Material - special handling may apply.

See www.dtsc.ca.gov/hazardouswaste/perchlorate.

Before Reading These Instructions

Panasonic welcomes you to our constantly growing family of electronic products owners. We endeavor to give you the advantages of precise electronic and mechanical engineering, manufactured with carefully selected components, and assembled by people who are proud of the reputation their work has built for our company. We know this product will bring you many hours of enjoyment, and after you discover the quality, value and reliability we have built into it, you too will be proud to be a member of our family.

Customer Services Directory

U.S.A.

Obtain Product Information and Operating Assistance; locate your nearest Dealer or Servicenter; purchase Parts and Accessories; or make Customer Service and Literature requests by visiting our Web Site at:

<http://www.panasonic.com/support>

or, contact us via the web at:

<http://www.panasonic.com/contactinfo>

You may also contact us directly at:

1-800-211-PANA (7262),

Monday-Friday 9 am-9 pm; Saturday-Sunday 10 am-7 pm, EST.

For hearing or speech impaired TTY users, TTY : 1-877-833-8855

Accessory Purchases:

Purchase Parts, Accessories and Instruction Books online for all Panasonic Products by visiting our Web Site at:

<http://www.pasc.panasonic.com>

or, send your request by E-mail to:

npcparts@panasonic.com

You may also contact us directly at:

1-800-332-5368 (Phone) 1-800-237-9080 (Fax Only) (Monday-Friday 9 am to 8 pm, EST.)

Panasonic Services Company

20421 84th Avenue South, Kent, WA 98032

(We accept Visa, MasterCard, Discover Card, American Express, and Personal Checks)

For hearing or speech impaired TTY users, TTY : 1-866-605-1277

Service in Puerto Rico

Panasonic Puerto Rico, Inc.

Panasonic Sales Company

Factory Servicenter:

Ave. 65 de Infantería, Km. 9.5, San Gabriel Industrial Park, Carolina, Puerto Rico 00985

Phone (787) 750-4300, Fax (787) 768-2910

CANADA

WARRANTY SERVICE

FOR PRODUCT OPERATION ASSISTANCE, please contact:

Our Customer Care Centre:

Telephone #:	(905) 624-5505
1-800 #:	1-800-561-5505
Fax #:	(905) 238-2360
Email link:	"Contact Us" on www.panasonic.ca

FOR PRODUCT REPAIRS, please locate your nearest Authorized Servicentre at www.panasonic.ca:

Link : "Servicentres™ locator" under "Customer support"

IF YOU SHIP THE PRODUCT TO A SERVICENTRE

Carefully pack and send prepaid, adequately insured and preferably in the original carton.

Include details of the defect claimed, and proof of date of original purchase.

Limited Warranty

U.S.A.

PANASONIC CONSUMER ELECTRONICS COMPANY,
DIVISION OF PANASONIC CORPORATION OF NORTH AMERICA
One Panasonic Way, Secaucus, New Jersey 07094

PANASONIC SALES COMPANY,
DIVISION OF PANASONIC PUERTO RICO, INC.
Ave. 65 de infanteria, Km. 9.5, San Gabriel Industrial Park
Carolina, Puerto Rico 00985

PANASONIC AUTO PRODUCTS LIMITED WARRANTY

LIMITED WARRANTY COVERAGE

If your product does not work properly because of defects in materials and workmanship.

Panasonic Consumer Electronics Company or Panasonic Sales Company (collectively referred to as "the warrantor") will, for the length of the period indicated in the chart below, which starts with the date of original purchase ("warranty period"), at its option either (a) repair your product with new or refurbished parts, or (b) replace it with a new or refurbished product. The decision to repair or replace will be made by the warrantor.

Categories	Parts	Labor
Audio Components (except items listed below)	One (1) Year	One (1) Year
MXE Series Audio Components (except items listed below)	Two (2) Years	Two (2) Years
Speakers Defective Car Audio Speakers under warranty must be exchanged at the place of purchase. Contact your Dealer for details.	One (1) Year	Not Applicable
Accessories (in exchange for defective items)	Ninety (90) Days	Not Applicable

During the "Labor" warranty period, there will be no charge for labor. During the "Parts" warranty period, there will be no charge for parts. You must carry in or mail in your product prepaid during the warranty period. If non-rechargeable batteries are included, they are not warranted. This warranty only applies to products purchased and serviced in the United States or Puerto Rico. This warranty is extended only to the original purchaser of a new product which was not sold "as is". A purchase receipt or other proof of the original purchase date is required for warranty service.

CARRY-IN OR MAIL-IN SERVICE

For Carry-In or Mail-In Service in the United States, call 1-800-211-PANA (7262) or visit

Panasonic Web Site: <http://www.panasonic.com>

For assistance in Puerto Rico, call Panasonic Sales Company (787)-750-4300 or fax (787)-768-2910.

LIMITED WARRANTY LIMITS AND EXCLUSIONS

This warranty ONLY COVERS failures due to defects in materials and workmanship, and DOES NOT COVER normal wear and tear or cosmetic damage. The warranty ALSO DOES NOT COVER damages which occurred during shipment, failures which are caused by products not supplied by the warrantor, failures which result from accident, misuse, abuse, neglect, bug infestation, mishandling, misapplication, alteration, faulty installation, set-up adjustment, maladjustment of consumer control, improper maintenance, improper antenna, inadequate signal reception or pickup, power line surge, improper voltage supply, lightning, modification, commercial use (such as use in hotels, offices, restaurants, or other business uses) or rental use of the product, or service by anyone other than the technician from Factory Servicenter or other authorized service centers, or damage that is attributable to acts of God.

THERE ARE NO EXPRESS WARRANTIES EXCEPT AS LISTED UNDER "LIMITED WARRANTY COVERAGE". THE WARRANTOR IS NOT LIABLE FOR INCIDENTAL OR CONSEQUENTIAL DAMAGES RESULTING FROM THE USE OF THIS PRODUCT, OR ARISING OUT OF ANY BREACH OF THIS WARRANTY. (As examples, this excludes damages for lost time, cost of having someone remove or re-install an installed unit if applicable, travel to and from the service center, and loss of media, data or other memory contents. The items listed are not exclusive, but are for illustration only.) **ALL EXPRESS AND IMPLIED WARRANTIES, INCLUDING THE WARRANTY OF MERCHANTABILITY, ARE LIMITED TO THE PERIOD OF THE LIMITED WARRANTY.**

Some states do not allow the exclusion or limitation of incidental or consequential damages, or limitations on how long an implied warranty lasts, so the exclusions may not apply to you.

This warranty gives you specific legal rights and you may also have other rights which vary from state to state. If a problem with this product develops during or after the warranty period, you may contact your dealer or Servicenter. If the problem is not handled to your satisfaction, then write to warrantor's Consumer Affairs Department at the addresses of the warrantor.

PARTS AND SERVICE WHICH ARE NOT COVERED BY THIS LIMITED WARRANTY ARE YOUR RESPONSIBILITY.

Customer's Record

Model

No. _____

Serial

No. _____

Dealer's

No. _____

Code

No. _____

Dealer's

Address _____

Date of

Purchase _____

CANADA

Panasonic Canada Inc.
5770 Ambler Drive, Mississauga Ontario L4W 2T3

PANASONIC PRODUCT LIMITED WARRANTY

Panasonic Canada Inc. warrants this product to be free from defects in materials and workmanship and agrees to remedy any such defect for a period as stated below from the date of original purchase.

CAR AUDIO PRODUCT – ONE (1) YEAR, PARTS AND LABOUR

(The labour to install or remove the product is not warranted)

ACCESSORIES - NINETY (90) DAYS, (IN EXCHANGE FOR DEFECTIVE ITEMS)

LIMITATIONS AND EXCLUSIONS

This warranty does not apply to products purchased outside Canada or to any product which has been improperly installed, subjected to usage for which the product was not designed, misused or abused, damaged during shipping, or which has been altered or repaired in any way that affects the reliability or detracts from the performance, nor does it cover any product which is used commercially. Dry cell batteries are also excluded from coverage under this warranty.

This warranty is extended to the original end user purchaser only. A purchase receipt or other proof of the original purchase date is required before warranty service is performed.

THIS EXPRESS, LIMITED WARRANTY IS IN LIEU OF ALL OTHER WARRANTIES, EXPRESS OR IMPLIED, INCLUDING ANY IMPLIED WARRANTIES OF MERCHANTABILITY AND FITNESS FOR A PARTICULAR PURPOSE. IN NO EVENT WILL PANASONIC CANADA INC. BE LIABLE FOR ANY SPECIAL, INDIRECT OR CONSEQUENTIAL DAMAGES.

In certain instances, some jurisdictions do not allow the exclusion or limitation of incidental or consequential damages, or the exclusion of implied warranties, so the above limitations and exclusions may not be applicable.

Features

■ Wide array of components for system upgrade

Various optional components allow users to obtain availability of wide range of system upgrade. Upgrading the system delivers relaxed AV space in a car. For further information, refer to the separate **System Upgrade Guidebook**.

● CD changer

The optional adapter (Conversion Cable for DVD/CD Changer: CA-CC30U) allows you to connect the optional Panasonic CD changer unit (CX-DP880).

● iPod®

The optional adapter (Direct Cable for iPod: CA-DC300U) allows you to connect the optional iPod series.

● XM Satellite Radio

You can connect the optional XM receiver (XMD1000) with optional Digital Adapter. For details, refer to the operating instructions for the XM receiver.

● Sirius Satellite Radio

You can connect the optional Sirius Satellite radio receiver (SIR-PAN1).

● Hands Free Phone System

You can connect the optional Bluetooth hands-free kit (CY-BT100U).

Note:

- CY-BT100U is designed **only for receiving calls**. It cannot send calls.
- You can connect the optional Expansion Module (hub unit) (CY-EM100U). Connection of the Expansion Module allows you to simultaneously connect optional devices mentioned before as well as other AV devices. For details, refer to the operating instructions for the Expansion Module.

■ Large-sized volume control

A large-sized rotary volume control that looks like one belonging to a Hi-Fi audio system is featured.

■ SQ (Sound Quality)

SQ is a function that can call up various sound types at the touch of button in accordance with your listening music type.

Contents

Common

Safety Information	2
Before Reading These Instructions	5
Customer Services Directory	5
Limited Warranty	6
Features	7
Contents	7
Accessories	8
Remote Control Unit	8
Preparation	9
● Remote Control Unit	
● Main Unit	
Cancellation of Demonstration	
Clock Setting	
General	10

Each source

Radio	12
Before Disc Playback	14
CD Player	15
MP3/WMA Player	16
Notes on MP3/WMA	18











As needed

Audio Settings	20
● Volume	
● Bass/Treble	
● Balance/Fader	
Function Settings	22
● Demonstration	
● Level Meter Display Patterns (PATTERN)	
● Mute/Attenuation	
● AUX Skip	
Anti-Theft System	24
Fuse	25
Maintenance	25
Notes on Discs	25
Troubleshooting	26
Specifications	31

Note:

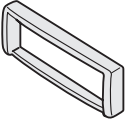
- Refer to the **System Upgrade Guidebook** for operation of optional devices such as a CD changer and iPod.

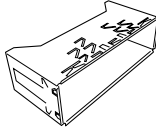
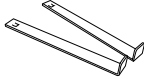
Accessories

					
Operating Instructions (YEFM285934)	System Upgrade Guidebook (YEFM262791)	Installation Instructions (YEFM294313)	Owners Information Card	Removable Face Plate Case (YEFA131839A) Q'ty: 1	Remote Control Unit (Includes a battery) (EUR7641010) Q'ty: 1
Instruction kit Q'ty: 1 set					
					
Trim Plate (YEFM051021) Q'ty: 1	Power Connector (YGAJ021012) Q'ty: 1	Mounting Collar (YEFX0217263A) Q'ty: 1	Lock Cancel Plate	Mounting Bolt (5 mmø)	Rubber Bushing
			Installation kit (YEP0FZ5698) Q'ty: 1 set		

Note:

- The number in parentheses underneath each accessory part name is the part number for maintenance and service.
- Accessories and their parts numbers are subject to modification without prior notice due to improvements.
- Trim Plate and Mounting Collar are mounted on the main unit at shipment.

Remote Control Unit

- This instruction manual explains operations for use with the buttons on the main unit. (Different operations excluded)

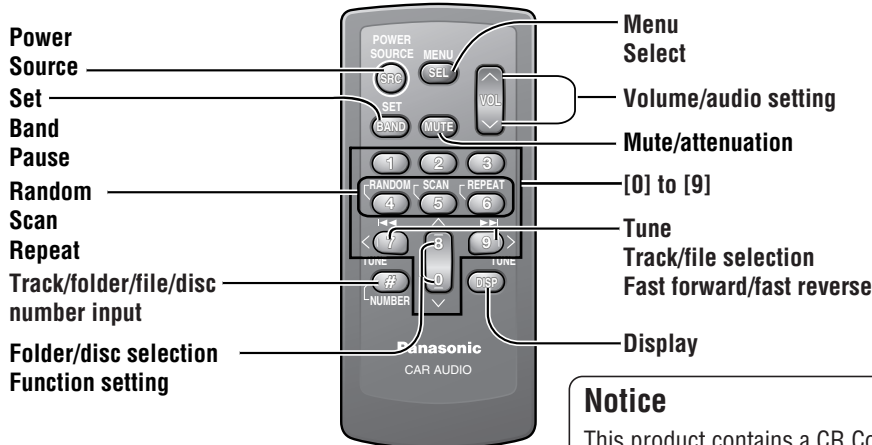

Notice

This product contains a CR Coin Cell Lithium Battery which contains Perchlorate Material - special handling may apply.
See www.dtsc.ca.gov/hazardouswaste/perchlorate.

Preparation

Remote Control Unit

Preparation Before Initial Use

Pull the insulation film out from the backside of the remote control gently.

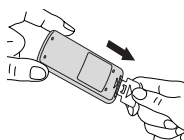

Battery Replacement

- Remove the battery holder with the remote control unit placed on a flat surface.
 - Stick your thumbnail into the groove and push the holder in the direction of the arrow at the same time.
 - Pull it out in the direction of the arrow using a tough pointed object.
- Put a battery in the case with (+) side facing up.
- Put the case back.

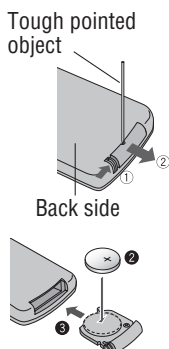

Warning

- Keep a battery away from children to avoid the risk of accidents. If an infant ingests a battery, please seek immediate medical attention.

Caution

- Remove and dispose of an old battery immediately.
- Do not disassemble, heat or short a battery. Do not throw a battery into a fire or water.
- Follow local regulations when disposing of a battery.
- Improper use of a battery may cause overheating, an explosion or ignition, resulting in injury or a fire.

Note:

- Battery Information:
 Battery Type: Panasonic lithium battery (CR2025)
 (Included in the remote control)
 Battery Life: Approximately 6 months under normal use
 (at room temperature)

Main Unit

Cancellation of Demonstration

The demonstration message appears for initial use.

- Set your car's ignition switch to the ACC or ON position. The demonstration screen appears.



- Press [SRC/PWR] to turn on the power.
- Press and hold [VOLUME] (PUSH SEL) for more than 2 seconds to open the menu.
- Press [VOLUME] (PUSH SEL) to select the Demonstration setting. ("DEMO" is displayed.)
- Turn [VOLUME] counterclockwise. (Press [0] (v) on the remote control unit.)



Note:

- To return to the regular mode, press [D] (DISP).
- Refer to the section on "Function Settings". (→ Page 22)

[D] (DISP/CLOCK)



[VOLUME]
(PUSH SEL: select)

[SRC/PWR] (Power)

[<] [>]
(Hour/minute adjustment)

Clock Setting

The 12-hour system is used for the clock.

- Press [SRC/PWR] to turn on the power.
- Press [D] (DISP/CLOCK).



Clock display

- Press and hold [D] (DISP/CLOCK) for more than 2 seconds.



Hour blinks

- Adjust the hour.
 [>]: put forward hour.
 [<]: put back hour.



Hour entered

- Press [D] (DISP/CLOCK).



Minute blinks

- Adjust the minute.
 [>]: put forward minute.
 [<]: put back minute.



Minute entered

- Press [D] (DISP/CLOCK).



Completed

Note:

- "ADJUST" is displayed before adjusting the clock.
- Press and hold [>] or [<] to change numbers rapidly.

General

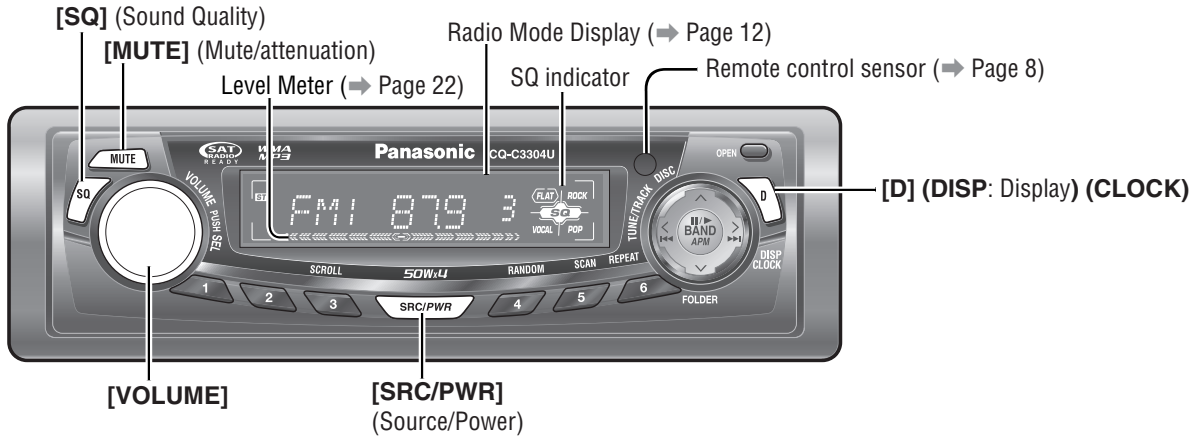

Power

Set your car's ignition switch to the ACC or ON position.

ON: Press [SRC/PWR].



OFF: Press and hold [SRC/PWR] for more than 1 second.

Volume

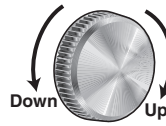

Default: 18
Setting range: 0 to 40

Note:

- The volume level can be set independently for each source. (For radio, one volume setting for AM, one volume setting for all FMs)

Mute/Attenuation **[MUTE]**

ON : Press [MUTE].

OFF : Press [MUTE] again.

You can select mute or attenuation. (→ Page 22)



[MUTE] indicator

Clock Display (at Power Off)

When the power of the unit is set to OFF, press [D] (DISP/CLOCK).



Clock time (Default)



(Display off)

When the power is set to ON, refer to the description for each source mode.

Source

Press [**SRC/PWR**] to change the source.

Radio

RADIO (⇒ Page 12)

CD Player

CD (⇒ Page 15)

OR

MP3/WMA Player

MP3/WMA (When an MP3/WMA data disc is in the player ⇒ Page 16)

AUX1

AUX1 (Sound source connecting to the AUX input terminal ⇒ Page 22, Installation Instructions)

An optional unit (ex. CD changer)

(if you connect it to System-up Connector of this unit directly)

CHANGER (Sound source connected to the System-up Connector of this unit directly ⇒ System Upgrade Guidebook)

OR

Some optional units (if you use the Expansion Module (CY-EM100U))

AUX2 (Sound source connecting to the AUX input terminal of Expansion Module ⇒ System Upgrade Guidebook)

(when connected)

Port 1

(Sound source connected to the port 1 of Expansion Module ⇒ System Upgrade Guidebook)

(when connected)

Port 2

(Sound source connected to the port 2 of Expansion Module ⇒ System Upgrade Guidebook)

(when connected)

Port 3

(Sound source connected to the port 3 of Expansion Module ⇒ System Upgrade Guidebook)

(when connected)

Port 4

(Sound source connected to the port 4 of Expansion Module ⇒ System Upgrade Guidebook)

Note:

- For information about connectable devices, refer to the **System Upgrade Guidebook** or the instruction manual for each device.

SQ (Sound Quality)

SQ is a function that can call up various sound types at the touch of button in accordance with your listening music type.

Press [**SQ**] to select the sound type as follows:



(FLAT) flat frequency response: does not emphasize any part. (Default)



(ROCK) speedy and heavy sound: exaggerates bass and treble.



(POP) wide-ranged and deep sound: slightly emphasizes bass and treble.



(VOCAL) clear sound: emphasizes middle tone and slightly emphasizes treble.

Press [**D**] (**DISP**) to return to the regular mode.

Note:

- Settings of SQ, bass/treble and volume are influenced one another. If such an influence causes distortion to the audio signal, readjust bass/treble or volume. (⇒ Page 20)

Radio

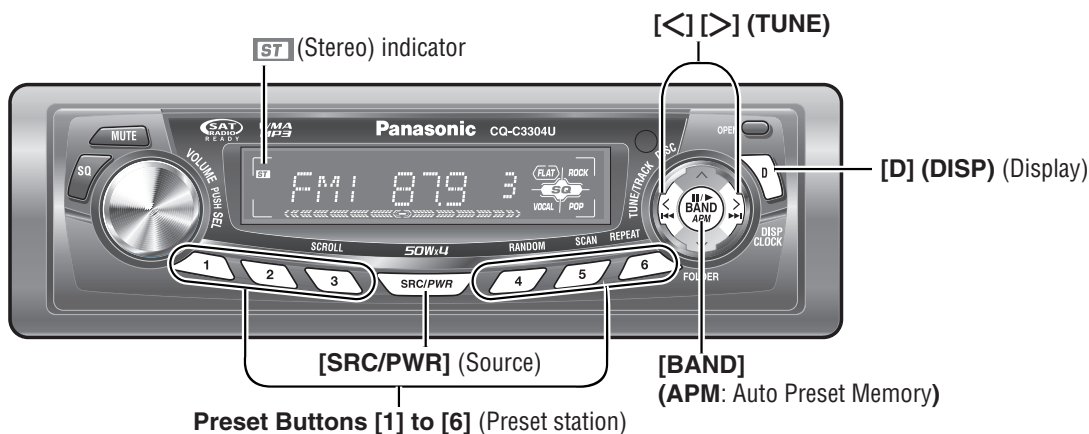

1 Radio Mode

Press **[SRC/PWR]** to select the radio mode.

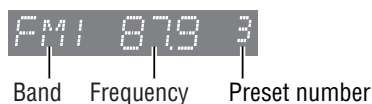

2 Band

Press **[BAND]**.

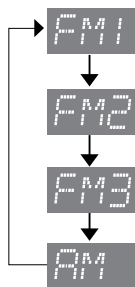

Display Change

Press **[D] (DISP)** to change the display as follows.

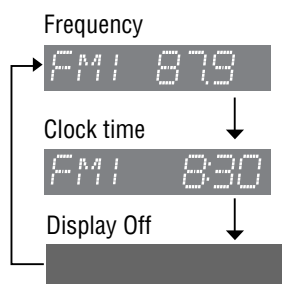

3 Tuning

[>]: Higher frequency

[<]: Lower frequency

Press and hold **[>]** or **[<]** for more than 0.5 seconds, then release it. Seeking will start.

Station Preset

Up to 6 stations can be stored in each of the FM1, FM2, FM3 and AM band selections.

Note:

- New stations overwrite existing saved stations after these procedures.

⚠ Warning

- To ensure safety, never attempt to preset stations while you are driving.

Auto Preset Memory (APM)

With this operation, stations with good receiving conditions can be automatically stored in the preset memory.

- ① Select a band. (⇒ Previous page)
- ② Press and hold **[BAND] (APM)** for more than 2 seconds.

6 stations with first to 6th highest in signal strength will be preset to each band.

Once set, the preset stations are sequentially scanned for 5 seconds each. (scanning)

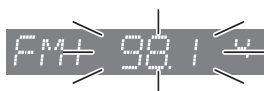

Note:

- To stop scanning, press one of the buttons from **[1]** to **[6]**.

Manual Preset Memory

With this operation, a station can be manually stored in the preset memory.

- ① Select a band and frequency. (⇒ Previous page)
- ② Press and hold one of the preset buttons from **[1]** to **[6]** until the display blinks once.

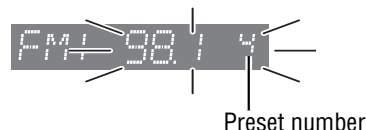

Preset Station Calling

- ① Select a band. (⇒ Previous page)
- ② Press one of the preset buttons from **[1]** to **[6]**.

Before Disc Playback

⚠ Caution

- Do not insert a disc when **DISC** indicator lights because a disc is already loaded.
- 8 cm (3") discs are not available for this unit, therefore, do not insert them.
- Do not use irregularly shaped discs.
- Do not use discs that have a seal or label attached.
- To avoid damaging the face plate, do not push it down or place objects on it while it is open.
- Do not pinch your finger or hand in the face plate.
- Do not insert foreign objects into the disc slot.

Available Discs

CD-R	CD-RW	CD-TEXT	CD-ROM
CD-DA MP3/WMA	CD-DA MP3/WMA	CD-DA -	- MP3/WMA

Note:

- Refer to the section on "Notes on MP3/WMA" (⇒ Page 18) and "Notes on Discs" (⇒ Page 25).
- The power will be turned on automatically when a disc is loaded.
- A disc which has both CD-DA data and MP3/WMA data on it may not be reproduced normally.

Disc Insert

- ① Press [OPEN].



- ② Insert a disc.

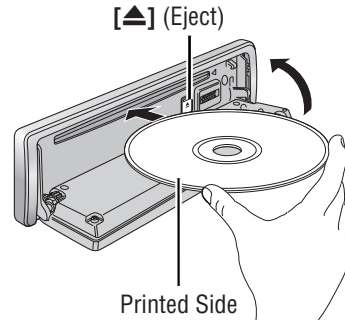

Disc Indicator

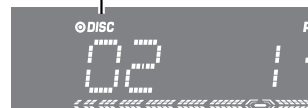

Note:

- It may take some time to start playing.
- ③ Close the face plate manually.
 - ④ Playback will start automatically after recognizing the data of the loading disc.

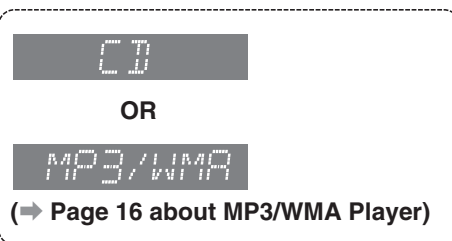

Disc Eject

- ① Press [OPEN].
- ② Press [▲] and take the disc out.
- ③ Close the face plate manually.

CD Player

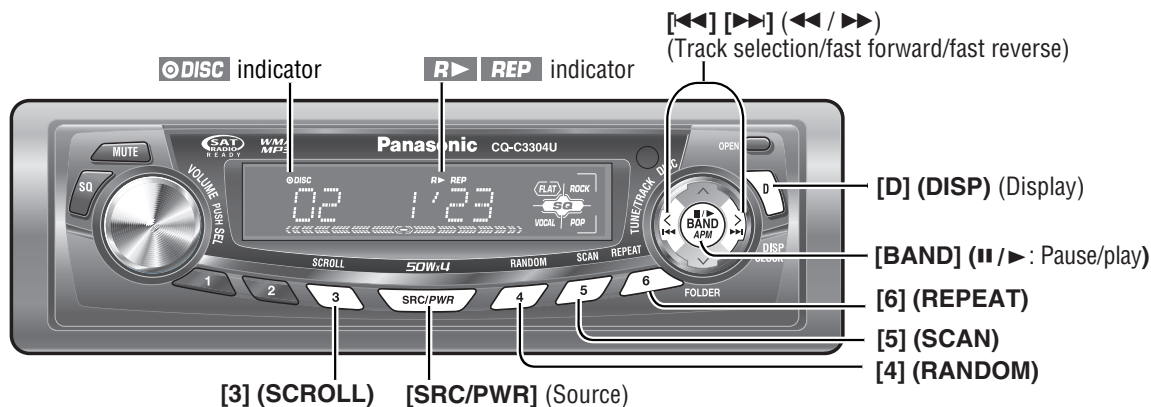

When CD is in the player **[DISC]**

Press **[SRC/PWR]** to select the CD player mode and play-back starts.

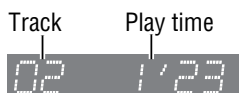

Display Change

Press **[D] (DISP)**.

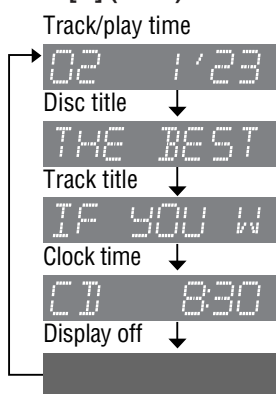

Note:

- "NO TEXT" is displayed when there is no information on the disc.
- To have another circle scroll while a title is displayed, press **[3] (SCROLL)**. If the number of displayed characters is 8 or less, the characters do not scroll.

Track Selection

[>>>]: Next track

[<<<]: Beginning of the current track
For the previous track, press twice.

Fast Forward/Fast Reverse

Press and hold

[>>>] (>>>): Fast forward

[<<<] (<<<): Fast reverse

Release them to resume normal playback.

Pause (II / ►)

Press **[BAND] (II / ►)**.

Press **[BAND] (II / ►)** again to cancel.

Random Play **[R]**

All the available tracks are played in a random sequence.

Press **[4] (RANDOM)**. **[R]** lights.

Press **[4] (RANDOM)** again to cancel.

Scan Play

The first 10 seconds of each track is played in sequence.

Press **[5] (SCAN)**.



Press **[5] (SCAN)** again to cancel.

Repeat Play **[REP]**

The current track is repeated.

Press **[6] (REPEAT)**. **[REP]** lights.

Press **[6] (REPEAT)** again to cancel.

Direct Track Selection

(Only for remote control unit)

Example: Track number 10



- ① Press **[#]**.
- ② Press **[1] [0]**.
- ③ Press **[BAND] (SET)**.

Note:

- To suspend direct selection, press **[DISP]**.
- Random, Scan and Repeat plays are canceled once **[#]** is pressed.

MP3/WMA Player

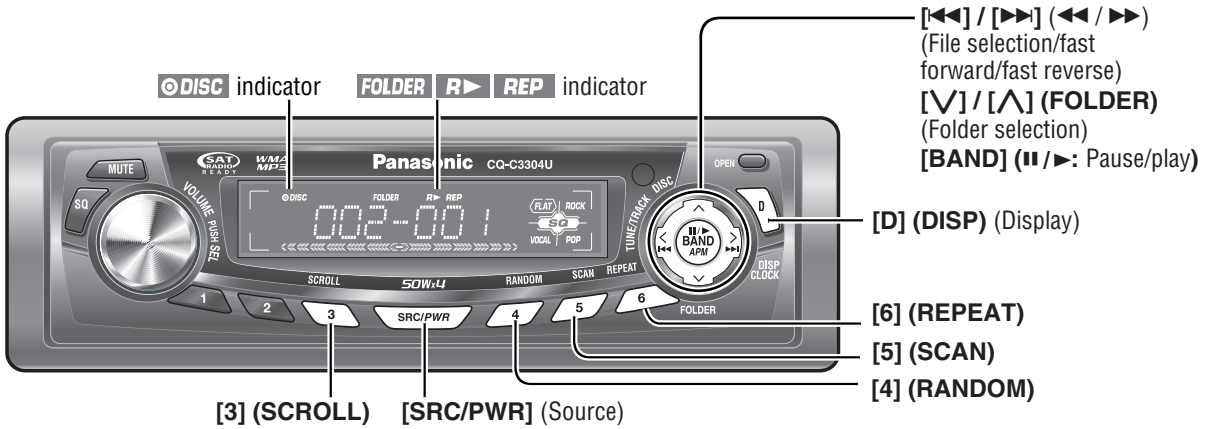

When a disc is in the player [DISC]

Press [SRC/PWR] to select the MP3/WMA player mode and playback starts.

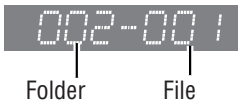

Display Change

Press [D] (DISP).

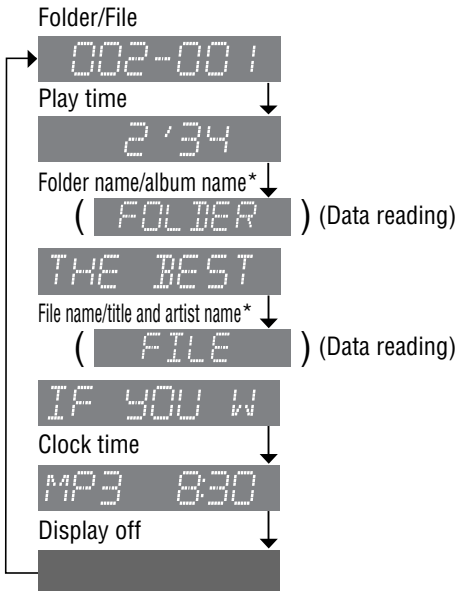

Note:

- "NO TEXT" is displayed when there is no information on the disc.
- To have another circle scroll while a title is displayed, press [3] (SCROLL). If the number of displayed characters is 8 or less, the characters do not scroll.

*ID3/WMA Tag Setting

Press and hold [3] (SCROLL) for more than 2 seconds.



When a folder name is displayed:

TAG ON: The album title is displayed.
TAG OFF: The folder name is displayed.

When a file name is displayed:

TAG ON: The title/artist name is displayed.
TAG OFF: The file name is displayed.

Folder Selection

[^]: Next folder
[V]: Previous folder

File Selection

[▶▶]: Next file
[◀◀]: Beginning of the current file
For the previous file, press twice.

Fast Forward/Fast Reverse

Press and hold
[▶▶] (▶▶): Fast forward
[◀◀] (◀◀): Fast reverse
Release them to resume normal playback.

Pause (|| / ▶)

Press [BAND] (|| / ▶).
Press [BAND] (|| / ▶) again to cancel.

Random Play **R▶**

All the available files are played in a random sequence.

Press **[4] (RANDOM)**. **R▶** lights.
Press **[4] (RANDOM)** again to cancel.

Folder Random Play **FOLDER R▶**

All the files in the current folder are played in a random sequence.

Press and hold **[4] (RANDOM)** for more than 2 seconds.
FOLDER R▶ light.
Press and hold **[4] (RANDOM)** again for more than 2 seconds to cancel.

Scan Play

The first 10 seconds of each file is played in sequence.

Press **[5] (SCAN)**.



Press **[5] (SCAN)** again to cancel.

Folder Scan Play **FOLDER**

From the next folder, the first 10 seconds of the first file in each folder is played in sequence.

Press and hold **[5] (SCAN)** for more than 2 seconds.
FOLDER lights.



Press and hold **[5] (SCAN)** again for more than 2 seconds to cancel.

Repeat Play **REP**

The current file is repeated.

Press **[6] (REPEAT)**. **REP** lights.
Press **[6] (REPEAT)** again to cancel.

Folder Repeat Play **FOLDER REP**

The current folder is repeated.

Press and hold **[6] (REPEAT)** for more than 2 seconds.
FOLDER REP light.
Press and hold **[6] (REPEAT)** again for more than 2 seconds to cancel.

Direct Selection

(Only for remote control)

Direct Folder Selection

Example: Folder number 5 (→ Page 19)



- ① Press **[#]** twice.
- ② Press **[5]**.
- ③ Press **[BAND] (SET)**.

Direct File Selection

Example: File number 10



- ① Press **[#]**.
- ② Press **[1] [0]**.
- ③ Press **[BAND] (SET)**.

Note:

- To suspend direct selection, press **[DISP]**.
- Random, Folder Random, Scan, Folder Scan, Repeat and Folder Repeat plays are canceled once **[#]** is pressed.

Notes on MP3/WMA

What is MP3/WMA?

MP3* (MPEG Audio Layer-3) and WMA (Windows Media™ Audio) are the compression formats of digital audio. The former is developed by MPEG (Motion Picture Experts Group), and the latter is developed by Microsoft Corporation. Using these compression formats, you can record the contents of about 10 music CDs on a single CD (This figure refers to data recorded on a 650 MB CD-R or CD-RW at a fixed bit rate of 128 kbps and a sampling frequency of 44.1 kHz).

*MPEG Layer-3 audio coding technology licensed from Fraunhofer IIS and Thomson.

Note:

- MP3/WMA encoding and CD writing software programs are not supplied with this unit.

Points to remember when making MP3/WMA files

Common

- High bit rate and high sampling frequency are recommended for high quality sound.
- Selecting VBR (Variable Bit Rate) is not recommended because playing time is not displayed properly and sound may be skipped.
- The playback sound quality differs depending on the encoding circumstances. For details, refer to the instructions of your own encoding software and writing software.

MP3

- It is recommended to set the bit rate to “128 kbps or more” and “fixed”.

WMA

- It is recommended to set the bit rate to “64 kbps or more” and “fixed”.
- Do not set the copy protection on the WMA file to enable this unit to play back.

Caution

- **Never assign the “.mp3”, or “.wma” file name extension to a file that is not in the MP3/WMA format. This may not only produce noise from the speaker damage, but also damage your hearing.**

Display Information

Displayed items

- | | |
|------------------|------------------------|
| • CD-TEXT | • MP3 (ID3 tag) |
| Disc title | Album name |
| Track title | Title and artist name |
| • MP3/WMA | • WMA (WMA tag) |
| Folder name | Album name |
| File name | Title and artist name |

Displayable characters

- Displayable length of file name/folder name: within 64 characters. (Unicode file and folder names are reduced by half in the number of displayable characters.)
- Name files and folders in accordance with the standard of each file system. Refer to the instructions of writing software for details.
- ASCII character set and special characters in each language can be displayed.
- Some Cyrillic characters in the Unicode can be displayed.

ASCII character set

A to Z, a to z, digits 0 to 9, and the following symbols:
(space) ! " # \$ % & ' () * + , - . / : ; < = > ? @ [\] ^ _ ` { | } ~

Special characters

À Á Â Ã Ä å Æ ç È É Ê Ë Ì Í Î Ï Ñ Ò Ó Ô Õ Ö ÷ ù ú û ü

Note:

- With some software in which MP3/WMA format files have been encoded, the character information may not be displayed properly.
- Undisplayable characters and symbols will be converted into an asterisk (*).
- It is recommended that the length of the file name is less than 8 (excluding the file extension).

Windows Media, and the Windows logo are trademarks, or registered trademarks of Microsoft Corporation in the United States and/or other countries/regions.



Recording MP3/WMA files on a CD-media

- You are recommended to minimize the chances of making a disc that contains both CD-DA files and MP3/WMA files.
- If CD-DA files are on the same disc as MP3 or WMA files, the songs may not play in the intended order, or some songs may not play at all.
- When storing MP3 data and WMA data on the same disc, use different folders for each data.
- Do not record files other than MP3/WMA files and unnecessary folder on a disc.
- The name of an MP3/WMA file should be added by rules as shown in the following descriptions and also comply with the rules of each file system.
- The file extension “.mp3” or “.wma” should be assigned to each file depending on the file format.
- You may encounter trouble in playing MP3/WMA files or displaying the information of MP3/WMA files recorded with certain writing software or CD recorders.
- This unit does not have a play list function.
- Although Multi-session recording is supported, the use of Disc-at-Once is recommended.

Supported file systems

ISO 9660 Level 1/Level 2, Apple Extension to ISO 9660, Joliet, Romeo

Note:

- Apple HFS, UDF 1.50, Mix CD and CD Extra are not supported.

Compression formats (Recommendation: “Points to remember when making MP3/WMA files” on the previous page)

Compression method	Bit rate	VBR	Sampling frequency
MPEG 1 audio layer 3 (MP3)	32 k – 320 kbps	Yes	32, 44.1, 48 kHz
MPEG 2 audio layer 3 (MP3)	8 k – 160 kbps	Yes	16, 22.05, 24 kHz
Windows Media Audio Ver. 2, 8, 9*	32 k – 192 kbps	Yes	32, 44.1, 48 kHz

* WMA 9 Professional/LossLess/Voice are not supported.

Folder selection order/file playback order

Maximum number of files/folders

- Maximum number of files/folders: 511 (files + folders)
- Maximum number of files in one folder: 255
- Maximum depth of trees: 8
- Maximum number of folders: 255 (Root folder is included.)

Note:

- You can shorten the duration between data read and playback by decreasing the quantity of files or folders, or the depth of the hierarchy.
- This unit counts the number of folders irrespective of the presence or absence of an MP3/WMA file.
- If the selected folder does not contain any MP3/WMA files, the nearest MP3/WMA files in the order of playback will be played.
- Playback order may be different from other MP3/WMA players even if the same disc is used.
- “ROOT” appears when displaying the root folder name.

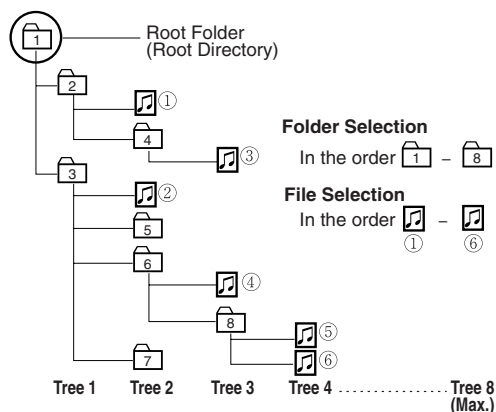

Copyright

It is prohibited by copyright laws to copy, distribute and deliver copyrighted materials such as music without the approval of copyright holder except enjoying yourself personally.

No warranty

Above description complies with our investigations as of September 2006. It has no warranty for reproducibility and displayability of MP3/WMA.

Audio Settings

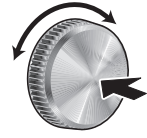
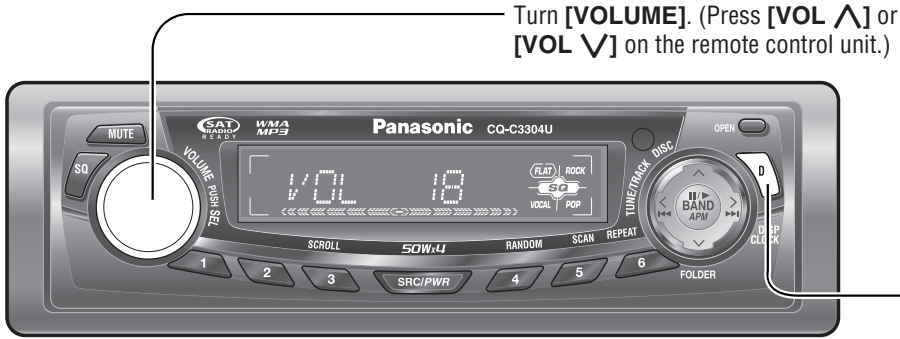

Press **[VOLUME]** (**PUSH SEL**: select).
(Press **[SEL]** on the remote control unit.)
[D] (DISP)
(Return to the regular mode.)

Volume

Default: 18
Setting range: 0 to 40

Press **[VOLUME]** (**PUSH SEL**)
to open the menu.

VOL 18

Bass/Treble

You can adjust the bass and treble sound.
Default: BAS (bass) 0 dB
TRE (treble) 0 dB
Setting range: -12 dB to +12 dB (by 2 dB)

Press **[VOLUME]** (**PUSH SEL**).

BASS

Press **[VOLUME]** (**PUSH SEL**).

TREBLE

Balance/Fader

You can adjust the sound level among the right, left, front and rear speakers.
Default: BAL (balance) CNT (center)
FAD (fader) CNT (center)
Setting range: 15 levels each and CNT (center)

Press **[VOLUME]** (**PUSH SEL**).

BALANCE

Press **[VOLUME]** (**PUSH SEL**).

FADER

Regular mode

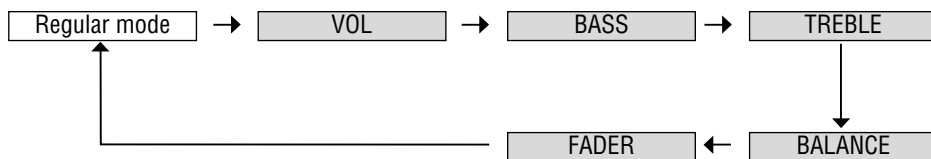

Note:

- The sequence and contents of setting items may depend on the conditions of devices to be connected. For further information, refer to the **System Upgrade Guidebook** or the instruction manuals for the devices to be connected.
- To return to the regular mode, press **[D] (DISP)**.
- If no operation takes place for more than 5 seconds in audio setting (2 seconds in the volume adjustment), the display returns to the regular mode.
- The volume can also be adjusted directly using **[VOLUME]** on the main unit. (⇒ Page 10)

	Turn [VOLUME] . ① : Up ② : Down	
	Turn [VOLUME] . ① : Up ② : Down	
	Turn [VOLUME] . ① : Up ② : Down	
	Turn [VOLUME] . ① : Right enhanced ② : Left enhanced	
	Turn [VOLUME] . ① : Front enhanced ② : Rear enhanced	

Function Settings

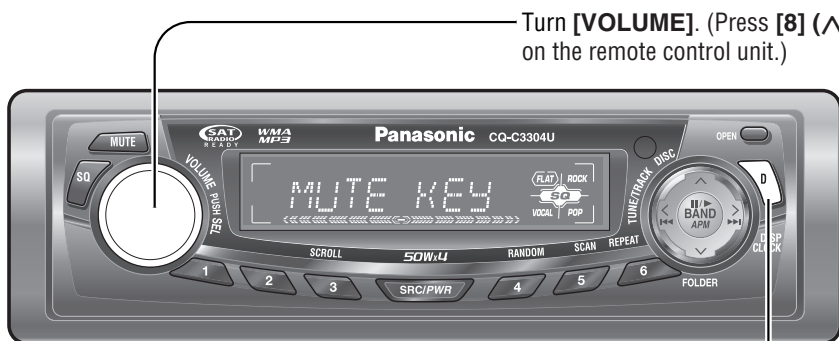

Turn **[VOLUME]**. (Press **[8]** (∧) or **[0]** (∨) on the remote control unit.)



Press and hold **[VOLUME]** (**PUSH SEL**: select) for more than 2 seconds. (Press and hold **[SEL]** (**MENU**) for more than 2 seconds on the remote control unit.)

[D] (**DISP**) (Return to the regular mode)

Demonstration

You can set up the monitor to display or hide the demonstration screen.
Default: ON

Press and hold **[VOLUME]** (**PUSH SEL**) for more than 2 seconds to open the menu.

DEMO

Level Meter Display Patterns (PATTERN)

Default: Pattern 1
Variety: 4 types, OFF

Press **[VOLUME]** (**PUSH SEL**).

PATTERN

Mute/Attenuation

You can select mute or attenuation. (→ Page 10)
Default: MUTE

Press **[VOLUME]** (**PUSH SEL**).

MUTE KEY

AUX Skip

If AUX1 is not used, the AUX mode is skipped when selecting the source.
Default: ON (Skip disabled)

Press **[VOLUME]** (**PUSH SEL**).

AUX 1 IN

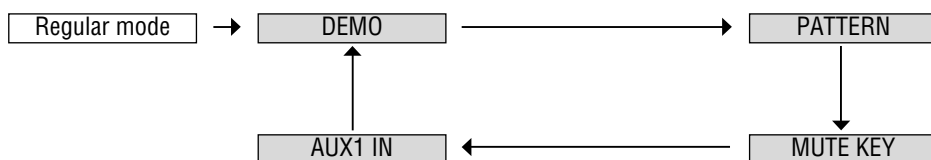

Note:

- The sequence and contents of setting items may depend on the conditions of devices to be connected. For further information, refer to the **System Upgrade Guidebook** or the instruction manuals for the devices to be connected.
- To return to the regular mode, press **[D] (DISP)**.
- If no operation takes place for more than 5 seconds in function setting, the display returns to the regular mode.

Turn **[VOLUME]**.

① **DEMO ON** : On (Default)

② **DEMO OFF** : Off

Note:

- Button operation with either the main unit or remote control allows users to cancel the demonstration screen for 20 seconds and enable the selected operation even in the demo-on mode.

Turn **[VOLUME]**.

OFF : Off

② ① **PATTERN1** : Pattern 1 (Default)

PATTERN4 : Pattern 4

Turn **[VOLUME]**.

① **KEY ATT** : 10 steps decrease (Attenuation)

② **KEY MUTE** : No sound (Mute) (Default)

Turn **[VOLUME]**.

① **AUX ON** : Skip disabled (Default)

② **AUX OFF** : Skip enabled

Anti-Theft System

This unit is equipped with a removable face plate. Removing this face plate makes the unit totally inoperable.

Remove the Face Plate

- ❶ Switch off the power of the unit. (→ Page 10)
- ❷ Press **[OPEN]**. The face plate will be opened.
- ❸ Push the face plate to either the right or left.
- ❹ Pull it out toward you.
- ❺ Gently press the bottom of the case and open the cover.
- ❻ Place the face plate into the case and take it with you when you leave the car.

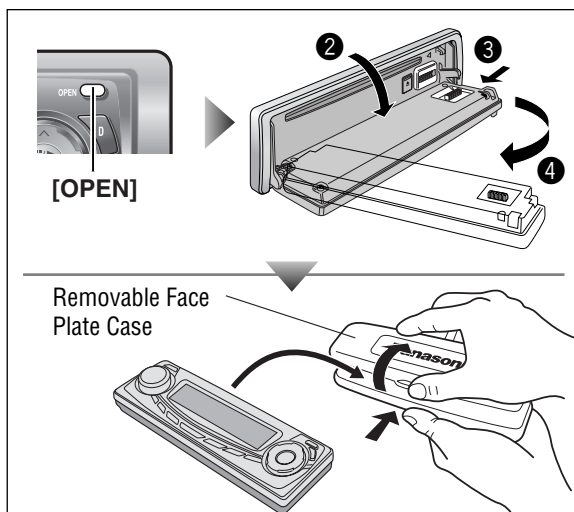

Install the Face Plate

- ❶ Fit the face plate with its left hole on the left pin provided on the main unit.
- ❷ Fit the other hole on the other pin applying slight pressure.
- ❸ Move the face plate up and down a few times to make sure it is secure. Then close the face plate and press down the right side of the face plate until it clicks into place.

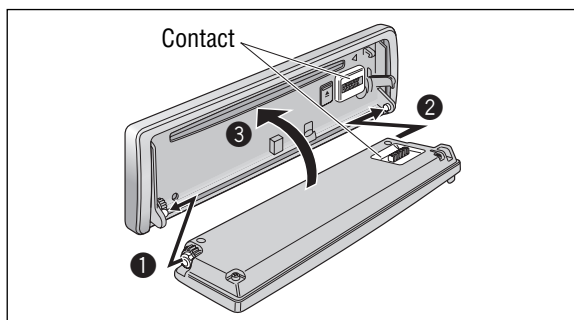

⚠ Caution

- This face plate is not waterproof. Do not expose it to water or excessive moisture.
- Do not remove the face plate while driving your car.
- Do not place the face plate on the dashboard or nearby areas where the temperature rises high.
- Do not touch the contacts on the face plate and on the main unit, since this may result in poor electrical contact.
- If dirt or other foreign substances get on the contacts, wipe them off with a clean and dry cloth.
- To avoid damaging the face plate, do not push it down or place objects on it while it is open.

If the fuse blows out, consult your dealer, or your nearest authorized Panasonic Servicenter.

⚠ Warning

- Use fuses of the same specified rating (**15 A**). Using substitutes or fuses with higher ratings, or connecting the unit directly without a fuse could cause fire or damage to the unit. **If the replaced fuse fails, contact your nearest authorized Panasonic Servicenter.**

Maintenance

This unit is designed and manufactured to ensure the minimum of maintenance. Use a dry, soft cloth for routine exterior cleaning. Never use benzine, thinner, or other solvents.

Notes on Discs

Notes on CD/CD Media (CD-R, CD-RW, CD-ROM)

If you use commercial CDs, they must have either of these labels shown at right.
Some copy-protected music CDs are not playable.



How to hold a disc

- Do not touch the underside of a disc.
- Do not scratch a disc.
- Do not bend a disc.
- When not in use, keep a disc in a case.

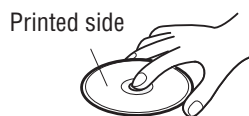

Do not leave discs in the following places:

- In direct sunlight
- Near car heaters
- Dirty, dusty and damp areas
- On seats and dashboards



Labels created by a printer, protective films or sheets



Irregularly shaped discs

Disc cleaning

Use a dry, soft cloth to wipe from the center outward.



Disc with adhered stickers or tape



Discs with cracks, scratches or parts missing

Do not write on the disc label with a ballpoint pen or other hard-point pens.

Notes on CD-Rs/RWs

- You may have trouble playing back some CD-R/RW discs recorded using CD recorders (CD-R/RW drives), either due to their recording characteristics or dirt, fingerprints, scratches, etc. on the disc surface.
- CD-R/RW discs are less resistant to high temperatures and high humidity than ordinary music CDs. Leaving them inside a car for extended periods may damage and make playback impossible.
- Some CD-R/RW discs cannot be played back successfully due to incompatibility among writing software, a CD recorder (CD-R/RW drive) and the discs.
- This player cannot play the CD-R/RW discs if the session is not closed.
- This player cannot play the CD-R/RW discs which contain other than CD-DA or MP3/WMA data.
- Be sure to observe the instructions of the CD-R/RW disc for handling it.

Troubleshooting

If You Suspect Something Wrong

Check and take steps as described below.

If the described suggestions do not solve the problem, it is recommended to take the unit to your nearest authorized Panasonic Servicenter. The product should be serviced only by qualified personnel. Please refer the checking and the repair to professionals. Panasonic shall not be liable for any accidents arising out of neglect of checking the unit or your own repair after your checking. **Never take measures especially those other than indicated by *italic* letters in "Possible Solution" described below because those are too dangerous for users to handle themselves.**

⚠ Warning

- Do not use the unit in an irregular condition, for example, without sound, or with smoke or a foul smell, which can cause ignition or electric shock. Immediately stop using the unit and consult your dealer.
- Never try to repair the unit by yourself because it is dangerous to do so.

■ Common

Problem	Possible cause → Possible solution
No power to the unit	<p>The power cord (battery, power and ground) is connected in the wrong way. → Check the wiring.</p> <p>Fuse blows out. → Eliminate the cause of fuse blowout and replace the fuse with new one. Consult your dealer.</p>
Sound is not generated.	<p>MUTE is set to ON. → Set MUTE to OFF.</p> <p>The wiring of speaker lines is not correct, or a break or poor contact arises. → Check the wiring in accordance with the wiring diagram. (→ Installation Instructions)</p>
Noise	<p>There is an electromagnetic-wave generator such as a cellular phone near the unit or its electrical lines. → Keep the electromagnetic-wave generator such as a cellular phone away from the unit and the wiring of the unit. If noise cannot be eliminated due to the wiring harness of the car, consult your dealer.</p> <p>The contact of the ground lead is poor. → Make sure that the ground lead is connected to an unpainted part of the chassis securely.</p>
Noise is made in step with engine revolutions.	<p>Alternator noise comes from the car. → Change the wiring position of the ground lead. → Mount a noise filter on the power supply.</p>
Some operations are not executable.	<p>Some operations are not executable in particular modes such as menu mode. → Read the operating instructions carefully and cancel the mode. If the unit is still out of order, consult your dealer.</p>
No sound from speaker(s)	<p>Balance/fader setting is not appropriate. → Readjust Balance/fader.</p> <p>There is a break, a short circuit, poor contact or wrong wiring regarding the speaker wiring. → Check the speaker wiring.</p>
The speaker channels are reversed between right and left.	<p>The speaker wiring is reversed between right and left. → Perform the speaker wiring in accordance with the wiring diagram.</p>

■ Common (continued)

Problem	Possible cause → Possible solution
The sound field is not clear in the stereo mode. Central sound is not settled.	The plus and minus terminals at right and left channels of speakers are connected reversely. → Perform the speaker wiring in accordance with the wiring diagram.
The power of the unit fails unintentionally.	The safety device works. → Consult your dealer, or your nearest Panasonic Servicenter.

■ Radio

Problem	Possible cause → Possible solution
Poor reception or noise	Antenna installation or wiring of antenna cable is faulty. → Check whether the antenna mounting position and its wiring are correct. In addition, check to see whether the antenna ground is securely connected to the chassis. No power is supplied to the antenna amplifier (when using a film antenna, etc.). → Check the wiring of the antenna battery lead.
The number of auto preset stations is less than 6.	The number of receivable stations is less than 6. → Move to an area where receivable stations number is maximum, and try presetting.
Preset stations cannot be stored.	The contact of the battery lead is poor, or the battery lead is not always powered. → Make sure that the battery lead is connected securely, and preset stations again.

Troubleshooting (continued)

CD

Problem	Possible cause → Possible solution
No playback or disc ejected	<p>The disc is inserted upside down. → Insert a disc correctly.</p> <p>There is a flaw or foreign object on the disc. → Remove the foreign object, or use a flawless disc.</p>
Sound skipping or noise	<p>There is a flaw or foreign object on the disc. → Remove the foreign object, or use a flawless disc.</p>
Sound skipping due to vibration	<p>The unit is not sufficiently secured. → Secure the unit to the console box.</p> <p>The unit is tilted at over 30° in the front-to-end direction. → Make the angle 30° or less.</p>
Disc unejectable	<p>Something such as a peeled label obstructs the disc coming out. → Consult your dealer.</p> <p>The microcontroller in the unit operates abnormally due to noise or other factors. → Unplug the power cord and plug it again. In case the unit is still out of order, consult your dealer.</p>

MP3/WMA

Problem	Possible cause → Possible solution
No playback or disc ejected	<p>The disc has unplayable formatted data. → Refer to the description about MP3/WMA for playable sound data except CD-DA (i.e. music CD).</p>
The CD-R/RWs that are playable on other devices are not playable on this unit.	<p>The playability of some CD-R/RWs may depend on the combination of media, recording software and recorder to be used even if these CD-R/RWs are playable on other devices such as a PC. → Make CD-R/RW discs in a different combination of media, recording software and recorder after referring to the description about MP3/WMA.</p>
Sound skipping or noise	<p>There is a flaw or foreign objects on the disc. → Remove the foreign objects, or use a flawless disc. For MP3/WMA, refer to the description about MP3/WMA.</p> <p>Playing VBR (Variable Bit Rate) files may cause sound skipping. → Play Non-VBR files.</p>

Note:

- Refer to “Notes on MP3/WMA” (⇒ Page 18)

■ Remote control unit

Problem

No response to pressing buttons

Possible cause → Possible solution

The battery is inserted in the wrong direction. A wrong battery is inserted.
 → ***Insert a correct battery in the correct direction.***

The battery is weak.
 → ***Replace the battery with new one.***





The aiming direction of the remote control unit is wrong.
 → ***Aim the remote control unit at the sensor of the unit and press buttons.***

The sensor is exposed to direct sunlight. (The remote control unit may not be operable when the sensor is exposed to direct sunlight. In such a case, the system is not faulty.)
 → ***Block off sunlight to the sensor.***

Troubleshooting (continued)

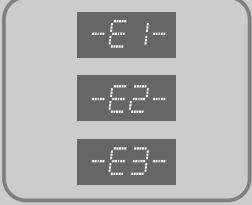
Error Display Messages

■ CD/MP3/WMA

Display	Possible cause → Possible solution
 <p>↓ After 5 seconds</p> 	<p>The disc is dirty or upside down. → Check the disc. (⇒ Page 25)</p> <p>The disc has scratches. → Check the disc. (⇒ Page 25)</p> <p>No operation by some cause. → Unplug the power cord and plug it again. In case the unit is still out of order, consult your dealer. (⇒ Installation Instructions)</p>
 <p>↓ After 5 seconds</p> <p>To next track/file automatically</p>	<p>The player cannot read the file you are trying to play for some reason. (File recorded in an unsupported file system, compression scheme, data format, file name extension, damaged data, etc.) → Select a file that the player can read. Check the type of data recorded on the disc. Create a new disc if necessary. (⇒ Page 18)</p>
 <p>↓ After 5 seconds</p> <p>To next track/file automatically</p>	<p>A WMA file can be copyrighted. → The file protected by copyright is not playable. (⇒ Page 18)</p>

Specifications

General		AM Radio	
Power supply	: DC 12 V (11 V – 16 V), test voltage 14.4 V, negative ground	Frequency range	: 530 kHz – 1 710 kHz
Current consumption	: Less than 2.1 A (CD mode, 0.5 W 4-channels)	Usable sensitivity	: 27 dB/μV (22 μV, S/N 20 dB)
Maximum power output	: 50 W x 4 (at 1 kHz) volume control maximum	CD Player	
Tone adjustment range	: Bass: ± 12 dB (at 100 Hz) Treble: ± 12 dB (at 10 kHz)	Sampling frequency	: 8 times oversampling
Speaker impedance	: 4 – 8 Ω	DA converter	: 1 bit DAC system
Pre-amp output voltage	: 2.5 V (CD mode, 1 kHz, 0 dB)	Pick-up type	: Astigma 3-beam
Pre-amp output impedance	: 200 Ω	Light source	: Semiconductor laser
Dimensions (W x H x D)	: 178 x 50 x 160 mm {7" x 1 15/16" x 6 5/16"}	Wave length	: 790 nm
Weight	: 1.4 kg {3 lbs. 1 oz}	Frequency response	: 20 Hz – 20 kHz (±1 dB)
		Signal to noise ratio	: 96 dB
		Total harmonic distortion	: 0.01 % (1 kHz)
		Wow and flutter	: Below measurable limits
		Channel separation	: 75 dB
FM Stereo Radio			
Frequency range	: 87.9 MHz – 107.9 MHz		
Usable sensitivity	: 10.2 dBf (0.9 μV, 75 Ω)		
50 dB quieting sensitivity	: 15.2 dBf (1.6 μV, 75 Ω)		
Frequency response	: 30 Hz – 15 kHz (±3 dB)		
Alternate channel selectivity	: 75 dB		
Stereo separation	: 35 dB (1 kHz)		
Image rejection ratio	: 55 dB		
IF rejection ratio	: 100 dB		
Signal to noise ratio	: 62 dB		

Above Specifications comply with EIA standards.

<p>Power Output: 18 W RMS x 4 Channels at 4 Ω and ≤ 1% THD+N Signal to Noise Ratio: 85 dBA (reference: 1 W into 4 Ω)</p>	
--	---

Note:

- Specifications and design are subject to modification without notice due to improvements.
- Some figures and illustrations in this manual may be different from your product.

**Panasonic Consumer
Electronics Company,
Division of Panasonic
Corporation of North America**
One Panasonic Way, Secaucus,
New Jersey 07094
<http://www.panasonic.com>

**Panasonic Sales Company,
Division of Panasonic Puerto
Rico, Inc. ("PSC")**
Ave. 65 de Infanteria, Km. 9.5
San Gabriel Industrial Park,
Carolina, Puerto Rico 00985
<http://www.panasonic.com>

Panasonic Canada Inc.
5770 Ambler Drive,
Mississauga, Ontario
L4W 2T3
<http://www.panasonic.ca>

YEFM285934

NT1106-0

Printed in China
Imprimé en Chine
Impreso en China