

# KitchenAid®

FOR THE WAY IT'S MADE.

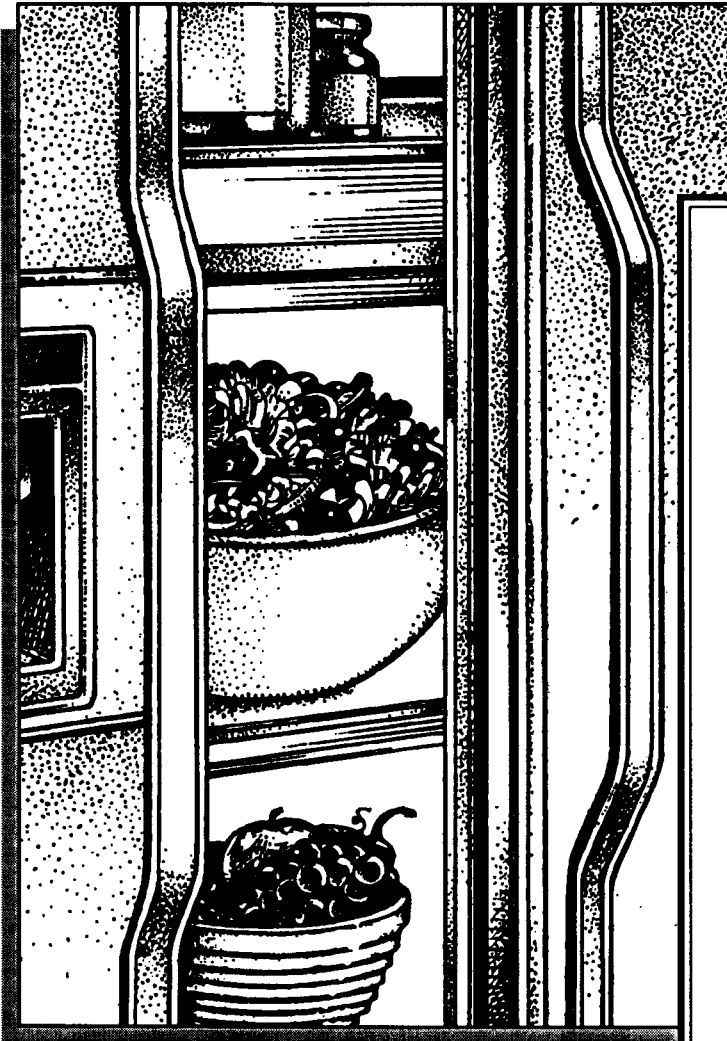

## **KitchenAid®** No-Frost Refrigerator Model KSRC22K

A Note To You .....	2
Important Safety Instructions	3
Parts And Features .....	4
Installing The Refrigerator .....	5
Using The Refrigerator .....	7
Caring For The Refrigerator	17
Food Storage Guide .....	20
If You Need Assistance Or Service .....	22
Warranty .....	24

Call Us With Questions  
Or Comments:

**1-800-422-1230**

9-92

## Use and Care Guide

# A Note To You

## Thank you for buying a KitchenAid home appliance.

You have purchased a quality, *world-class* home appliance. Years of engineering experience have gone into its manufacturing. To ensure that you will enjoy many years of trouble-free operation, we have developed this Use and Care Guide. It is full of valuable information on how to operate and maintain your home appliance properly and safely. Please read it carefully. Also, please complete and mail the Ownership Registration Card provided with your home appliance.

## Your safety is important to us.

This guide contains safety symbols and statements. Please pay special attention to these symbols and follow any instructions given. Here is a brief explanation of the use of each symbol.

### **⚠ WARNING**

This symbol will help alert you to such dangers as personal injury, burns, fire and electrical shock.

### **⚠ CAUTION**

This symbol will help you avoid actions which could cause product damage (scratches, dents, etc.) and damage to your personal property.

## Our Consumer Assistance Center telephone number, 1-800-422-1230, is toll-free, 24 hours a day.

If you ever have a question concerning your home appliance's operation, or if you need service, feel free to call our toll-free Consumer Assistance Center telephone number for help. When calling, you will need to know your appliance's complete model number and serial number. You can find this information on the model and serial number label (see diagram on page 4). For your convenience, below we have included a handy place for you to record these numbers. Also, please record the date the product was purchased/installed and the Builder's or Dealer's name, address and phone number. You will need this information if you ever require service. Keep this book and the sales slip together in a safe place for future reference.

**IMPORTANT:** You must provide proof of purchase or installation date for in-warranty service.

Model Number \_\_\_\_\_ Builder/Dealer Name \_\_\_\_\_

Serial Number \_\_\_\_\_ Address \_\_\_\_\_

Date Purchased \_\_\_\_\_ Phone \_\_\_\_\_

Date Installed \_\_\_\_\_

### Don't forget, KitchenAid offers a full line of quality home appliances.

Built-In Refrigerators	Trash Compactors	Ranges & Cooktops
Freestanding Refrigerators	Hot Water Dispensers	Microwave Ovens
50-Pound Ice Makers	Food Waste Disposers	Washers & Dryers
Dishwashers	Built-In Ovens	Mixers

For more information on these appliances, or the one you have purchased, call our toll-free Consumer Assistance Center telephone number, 1-800-422-1230.

# Important Safety Instructions

## **⚠ WARNING**

To reduce the risk of fire, electrical shock, or injury when using the refrigerator, follow basic precautions including the following:

- Read all instructions before using the refrigerator.
- Child entrapment and suffocation are not problems of the past. Junked or abandoned refrigerators are still dangerous ... even if they will "just sit in the garage for a few days."  
If you are getting rid of your old refrigerator, do it safely. Please read the enclosed safety booklet from the Association of Home Appliance Manufacturers. Help prevent accidents.
- Never allow children to operate, play with or crawl inside the refrigerator.
- Never clean refrigerator parts with flammable fluids. The fumes can create a fire hazard or explosion.

**• FOR YOUR SAFETY •**

DO NOT STORE OR USE GASOLINE OR OTHER FLAMMABLE VAPORS AND LIQUIDS IN THE VICINITY OF THIS OR ANY OTHER APPLIANCE. THE FUMES CAN CREATE A FIRE HAZARD OR EXPLOSION.

**– SAVE THESE INSTRUCTIONS –**

## Help us help you

Please:

- Install and level unit on a floor that will hold the weight, and in an area suitable for its size and use.
- Connect only to the proper kind of outlet, with the correct electrical supply and grounding. (Refer to the Electrical Requirements and Grounding Instructions Sheet.)
- Use unit only for the uses described in this manual.
- Make sure unit is not near an oven, radiator or other heat source.
- Properly maintain unit.
- Make sure unit is used in an area where the room temperature will not fall below 55°F (13°C).
- Make sure unit is not used by anyone unable to operate it properly.
- Make sure unit is not loaded with food before it has time to get properly cold.

# Parts And Features

This section contains captioned illustrations of your appliance. Use them to become familiar with where all parts and features are located and what they look like.

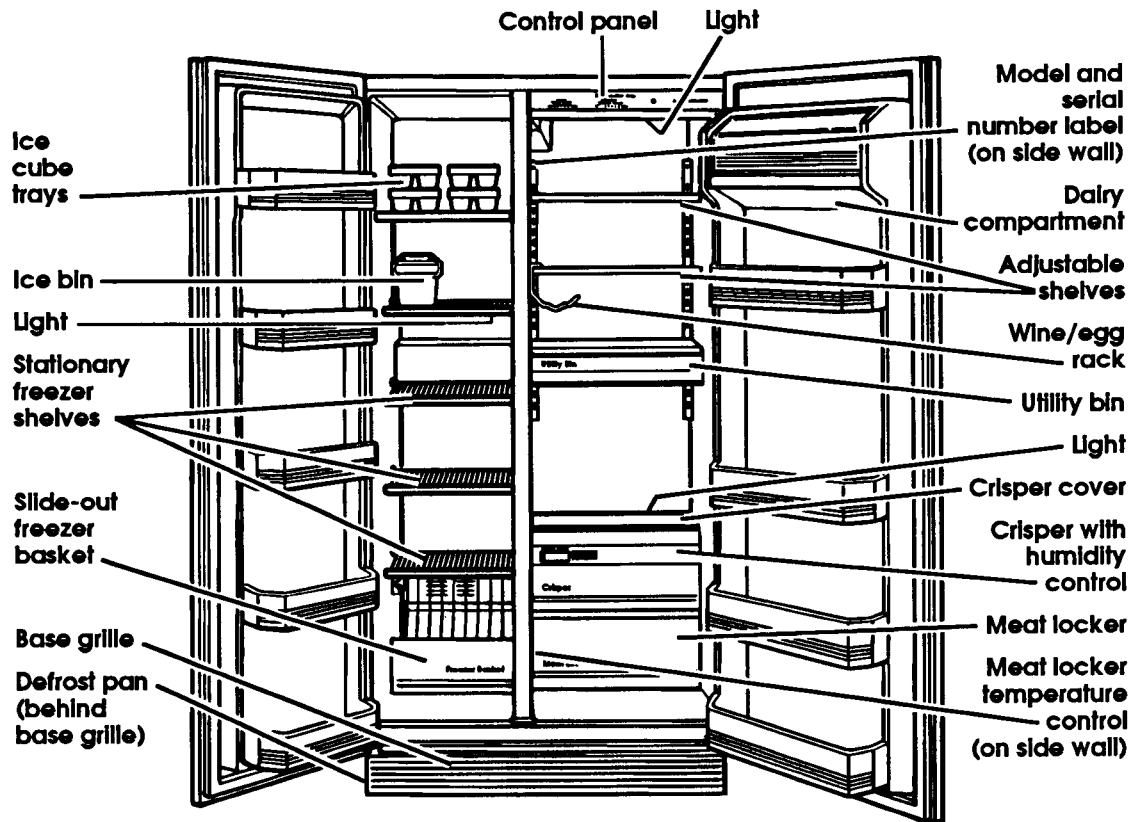

## Control Panel

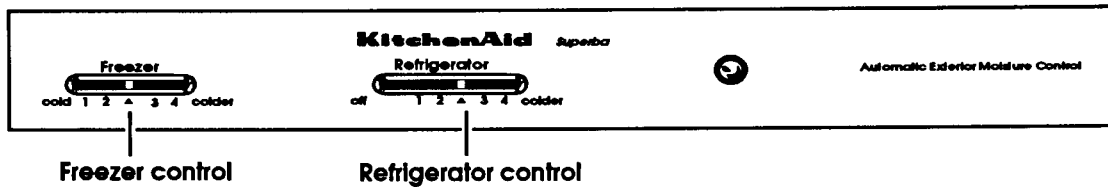

# Installing The Refrigerator

In This Section		Page	Page
Cleaning the refrigerator .....	5	Locating the refrigerator properly .....	6
Plugging in the refrigerator .....	5	Leveling the refrigerator .....	6

If you want your refrigerator to work properly, you need to install it properly. This section will tell you all you need to know to install your refrigerator.

## Cleaning the refrigerator

Clean your refrigerator before using it, if necessary. See cleaning instructions on page 17.

Remove the Consumer Buy Guide Label and any shipping tape before using the refrigerator.

### To remove any remaining glue:

- Rub briskly with your thumb to make a ball, then remove.
- OR
- Soak area with liquid dishwashing detergent before removing glue as described above.

**IMPORTANT: DO NOT USE** sharp instruments, rubbing alcohol, flammable fluids or abrasive cleaners. These can damage the material. See "Important Safety Instructions" on page 3. **DO NOT REMOVE** the Tech Sheet fastened under the refrigerator, behind the base grille.

## Plugging in the refrigerator

A 115 Volt, 60 Hz., AC only, 15 or 20 amp fused and properly grounded electrical supply is required. It is recommended that a separate circuit, serving only this appliance, be provided.

Do not use an extension cord. Use a receptacle which cannot be turned off with a switch or pull chain. See Electrical Requirements and Grounding Instructions Sheet in your Literature Package.

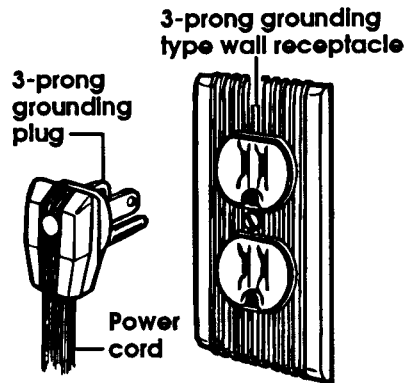

Recommended grounding method

## Locating the refrigerator properly

1. Allow ½ inch (1.25 cm) on each side of the refrigerator for ease of installation.
2. The refrigerator back can be flush against the wall.
3. If the refrigerator is to be against a wall, you might want to leave extra space on the hinge side closest to the wall so the door can be opened wider.

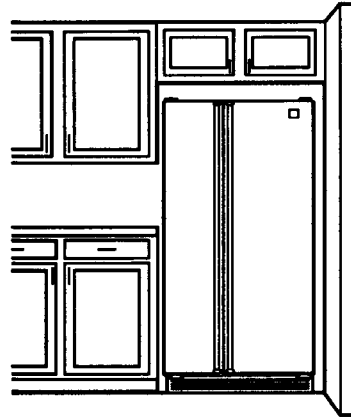

## Leveling the refrigerator

Your refrigerator has 2 leveling screws—one on the right and one on the left. To adjust one or both of these, follow the directions below.

1. Remove the base grille. (See page 14.)
2. To raise front, turn screw clockwise.
3. To lower front, turn screw counter-clockwise.
4. Check with level.
5. Replace base grille. (See page 14.)

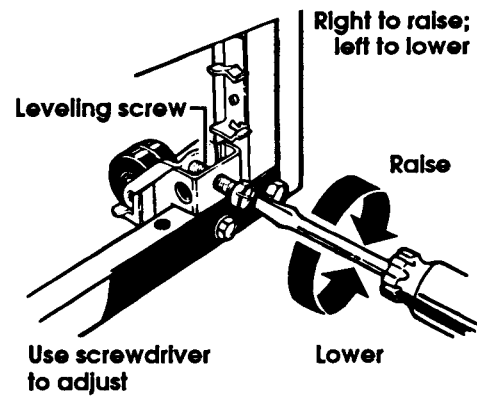

# Using The Refrigerator

In This Section		Page	Page
Setting the controls .....	7	Removing the freezer basket .....	12
Changing the control settings.....	8	Removing the freezer shelves .....	12
Adjusting the refrigerator shelves .....	9	Using the ice cube trays .....	12
Using the wine/egg rack .....	9	Using the optional ice maker .....	13
Removing the utility bin .....	9	Removing the base grille .....	14
Removing the crisper and cover .....	10	Removing the defrost pan .....	14
Adjusting the crisper humidity control ..	10	Changing the light bulbs.....	15
Removing the meat locker .....	11	Understanding the sounds you may hear .....	16
Adjusting the meat locker temperature control.....	11	Saving energy .....	16

In order to obtain the best possible results from your refrigerator, it is important that you operate it properly. This section will tell you how to do just that.

## Setting the controls

Controls for the refrigerator and freezer are in the refrigerator. When the refrigerator is first plugged in:

1. Set the Refrigerator Control to ▲ (between numbers 2 and 3).
2. Set the Freezer Control to ▲ (between numbers 2 and 3).
3. Give the refrigerator time to cool down completely before adding food. This may take several hours.

The settings indicated above should be correct for normal, household refrigerator usage. The controls will be set correctly when milk or juice is as cold as you like and when ice cream is firm. If you need to adjust these settings, see "Changing the control settings" on page 8.

**IMPORTANT:** The Automatic Exterior Moisture Control continuously guards against moisture build-up on the outside of the refrigerator cabinet. This control does not have to be set or adjusted.

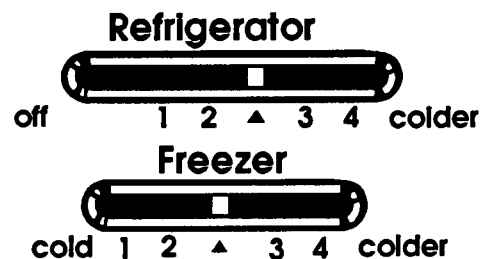

## Changing the control settings

To change the temperature settings, follow the steps below:

1. Adjust the Refrigerator Control first.
2. Wait at least 24 hours before making further adjustments. This gives the refrigerator and/or freezer time to reach the set temperature.
3. Adjust the Freezer Control if necessary.

To make the refrigerator or freezer colder, slide the control toward the number 4 setting. To make the refrigerator or freezer less cold, slide the control toward the number 1 setting.

Changing either the Refrigerator Control or the Freezer Control will affect the temperatures of both compartments.

Use the settings listed in the chart below as a guideline when adjusting the temperature controls.

The following reasons can cause the conditions listed below:

- Door opened often
- Large amount of food added
- Room temperature too warm
- Room temperature too cold (Refrigerator can't cycle often enough.)
- Controls not set correctly for your conditions
- Heavy ice usage

CONDITION:	RECOMMENDED CONTROL SETTING ADJUSTMENTS:	
	REFRIGERATOR	FREEZER
Refrigerator section is too warm	3	2
Freezer section is too warm	3	3
Refrigerator section is too cold	2	3
Ice isn't made fast enough	3	3
Both sections are too warm	3	3



## Adjusting the refrigerator shelves

Shelves can be adjusted to match the way you use your refrigerator.

### To remove shelves:

1. Tilt shelf up at front.
2. Lift shelf up at back.
3. Pull shelf straight out.

**IMPORTANT:** Glass shelves are heavy. Handle with care.

### To replace shelves:

1. Guide the rear hooks of shelf into slots in the shelf supports.
2. Tilt shelf up at front until hooks drop into slots. Lower front of shelf to level position.
3. Check the stability of the shelf to be sure hooks have been inserted properly.

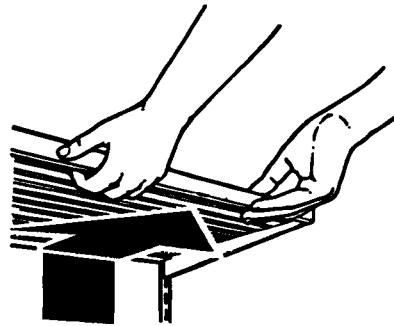

## Using the wine/egg rack

The rack is shaped to hold either a bottle of wine or a carton of eggs securely. The rack can hang over the left or right side of any refrigerator shelf.

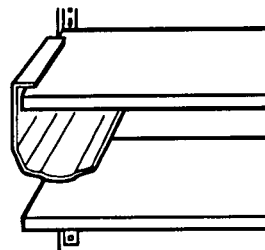

## Removing the utility bin

### To remove utility bin:

1. With an even, constant motion, slide utility bin out to the stop.
2. Lift the front.
3. Slide utility bin out the rest of the way.
4. Replace in reverse order.

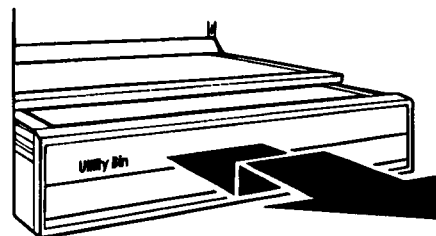

## Removing the crisper and cover

### To remove crisper:

1. Slide crisper out to the stop.
2. Lift crisper front and pull out the rest of the way.

### To replace crisper:

1. Position crisper slides on the front of the track.
2. Push crisper up and onto track.
3. Slide crisper in until it stops.

### To remove glass cover:

1. Remove top crisper.
2. Tilt cover up at front.
3. Lift cover at back and pull straight out.
4. Replace in reverse order.

**IMPORTANT:** Glass shelves are heavy. Handle with care.

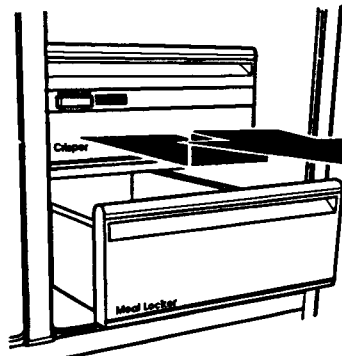

## Adjusting the crisper humidity control

You can control the amount of humidity in the moisture-sealed crisper.

- The control can be adjusted to any setting between LOW and HIGH.
- LOW (open) lets moist air out of the crisper for best storage of fruits and vegetables with skins.
- HIGH (closed) keeps moist air in the crisper for best storage of fresh, leafy vegetables.

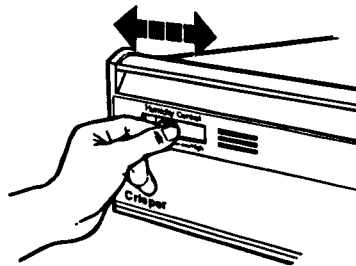

## Removing the meat locker

### To remove meat locker:

1. Slide meat locker out to the stop.
2. Lift meat locker front and pull out the rest of the way.

### To replace meat locker:

1. Position meat locker slides on the front of the track.
2. Push meat locker up and onto track.
3. Slide meat locker in until it stops.

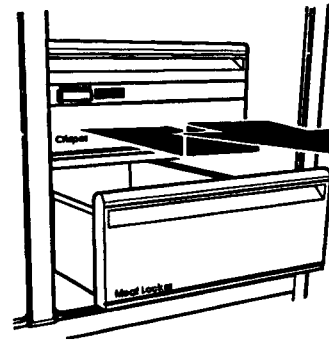

## Adjusting the meat locker temperature control

The Meat Locker Temperature Control allows you to adjust the meat locker storage temperature.

Cold air flows against the meat locker through an opening between the freezer and the refrigerator. Slide the control up or down to allow more or less cold air through the opening. This helps keep the meat locker colder than the rest of the refrigerator for best storage of meats.

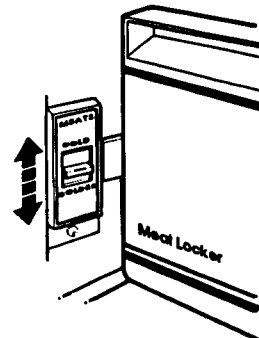

## Removing the freezer basket

### To remove baskets:

1. Slide basket out to the stop.
2. Lift basket at front to clear the stop.
3. Slide basket out the rest of the way.

### To replace baskets:

1. Place basket on the slides.
2. Lift basket at front to clear the stops.
3. Slide basket in until it stops.

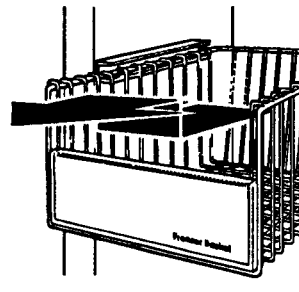

## Removing the freezer shelves

### To remove a shelf:

1. Lift right side of shelf off supports.
2. Slide shelf out of shelf support holes.
3. Replace in reverse order.

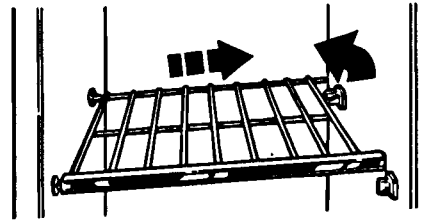

## Using the ice cube trays

If cubes are not used, they may shrink. The moving cold air starts a slow evaporation. The longer cubes are stored, the smaller they get.

### To remove ice:

1. Hold tray at both ends.
2. Twist slightly.

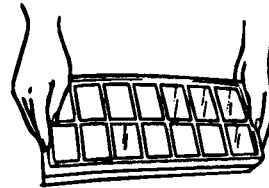

## Using the optional ice maker

If you have an automatic ice maker, or if you plan to add one later (Part No. KIMS8), there are a few things you will want to know:

- The ON/OFF lever is a wire signal arm.

Down ... to make ice automatically.

Up ... to shut off the ice maker.

**NOTE: Do not turn ice maker on until it is connected to the water supply. Instructions for ice maker water supply hook up are attached to the back of the refrigerator cabinet.**

- The dial or lever on the side of the ice maker changes the size of the cubes.
- Shake the bin occasionally to keep cubes separated and to obtain increased storage capacity.
- It is normal for ice crescents to be attached by a corner. They will break apart easily.
- You will hear water running when ice maker is working. You'll hear ice fall into the bin. Don't let these sounds bother you.
- The ice maker will not operate until the freezer is cold enough to make ice. This can take overnight.
- Because of new plumbing connections, the first ice may be discolored or off-flavored. Discard the first few batches of ice.
- If ice is not being made fast enough and more ice is needed, turn the Refrigerator Control toward a higher number. Wait a day and, if necessary, turn the Freezer Control toward 4.
- If you remove the ice bin, raise the signal arm to shut off the ice maker. When you return the bin, push it in all the way and lower the signal arm to the ON position.
- If cubes are stored too long, they may develop an off-flavor ... like stale water. Throw them away. Ice maker will make new ice. Cubes in the ice bin can also become smaller by evaporation.
- Good water quality is important for good ice quality. It is not recommended that the ice maker be connected to a softened water supply. Water softener chemicals, such as salt from a malfunctioning softener, can damage the ice maker mold and lead to poor ice quality. If a softened water supply cannot be avoided, it is important that the water softener be well maintained and operating properly.

Raise signal arm to stop ice.

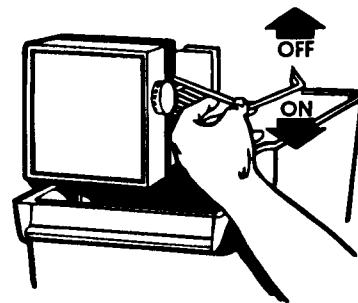

Lower signal arm to start it.

## Removing the base grille

### To remove base grille:

1. Open both doors.
2. Pull base grille forward to release the support tabs from the metal clips.
3. **Do not remove Tech Sheet** fastened behind the base grille.

### To replace base grille:

1. Line up base grille support tabs with metal clips.
2. Push base grille firmly to snap into place.
3. Close the doors.

See cleaning instructions for defrost pan and condenser coils on page 18.

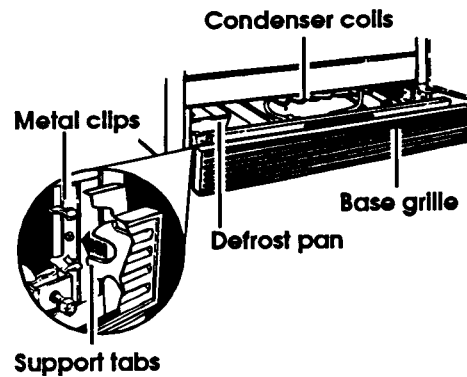

## Removing the defrost pan

### ⚠ WARNING

#### Personal Injury Hazard

Refrigeration system tubes are located above the defrost pan and can become hot. Remove and install defrost pan carefully.

Failure to do so could result in personal injury.

### To remove defrost pan:

1. Remove base grille. (See above.)
2. Lift defrost pan over wire brace. Remove tape, if any.
3. Clean as described on page 18.

### To replace defrost pan:

1. Replace pan with notched corner to the rear.
2. Push defrost pan in all the way. Make sure the defrost drain tube is directed into defrost pan.
3. Replace base grille. (See above.)

## Changing the light bulbs

### **⚠ WARNING**

#### **Electrical Shock Hazard**

Before removing a light bulb, either unplug the refrigerator or disconnect the electricity leading to the refrigerator at the main power supply.

Failure to do so could result in personal injury or electrical shock.

#### **To change refrigerator light:**

1. Disconnect refrigerator from power supply.
2. Reach behind Control Console to remove bulb.
3. Remove bulb and replace with a 40-watt tubular appliance bulb.
4. Reconnect refrigerator to power supply.

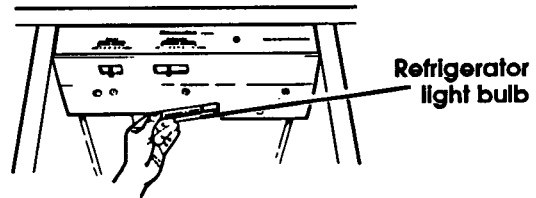

#### **To change crisper light:**

1. Disconnect refrigerator from power supply.
2. Remove crisper and cover. (See page 10.)
3. Remove bulb and replace with a 40-watt appliance bulb.
4. Reconnect refrigerator to power supply.

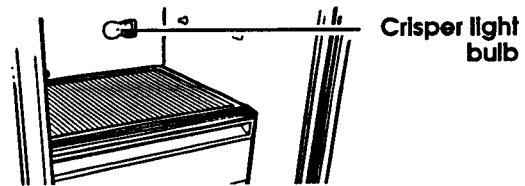

#### **To change freezer light:**

1. Disconnect refrigerator from power supply.
2. Grasp front of light shield.
3. Pull bottom of light shield forward until it snaps free.
4. Remove bulb and replace with a 40-watt appliance bulb.
5. Press light shield straight on until it snaps into place.
6. Reconnect refrigerator to power supply.

**IMPORTANT:** Not all commercial appliance bulbs will fit your refrigerator. Be sure to replace a bulb with one of the same size and shape.

## Understanding the sounds you may hear

Your new refrigerator may make different sounds than your previous one. Hard surfaces such as the ceiling, walls and cabinets around the refrigerator can make these sounds seem louder.

The following chart describes the kinds of sounds that might be new to you and what causes them.

SOUNDS/OBSERVATIONS	CAUSES
<b>Hum or hiss</b>	The refrigerator's fan motor and moving air.
<b>Clicking or snapping sounds</b>	The thermostat makes a definite click when the refrigerator stops running. It also makes a sound when the refrigerator starts. The defrost timer will click when the defrost cycle starts and stops.
<b>Running sounds</b>	The high-efficiency compressor and motor will run longer than older designs.
<b>Trickling water/water sounds</b>	During the defrost cycle, the refrigerator will not be running. The trickling water is the frost accumulation on the freezer coil melting and running into the defrost pan. When the refrigerator stops running, you may hear gurgling in the tubing for a few minutes.
<b>Ice maker sounds</b> • trickling water • clatter of ice	You may hear buzzing (from the water valve), trickling water and the clatter of ice falling into the bin.

## Saving energy

- Open the doors as few times as possible. Keep food organized so you do not have to search for what you want. Get everything you need out at one time. Close the doors as soon as food is removed.
- Make sure your refrigerator is not next to a heat source such as a range, water heater, furnace, radiator or in direct sunlight.
- Set the refrigerator and freezer temperatures to suit your needs—ice cream should be firm and beverages should be as cold as you like them. Avoid setting the refrigerator and freezer temperatures colder than necessary.
- Check the door gasket for a tight seal. Level the cabinet to be sure of a good seal.
- Clean the condenser coils regularly.



# Caring For The Refrigerator

In This Section		Page	Page
Cleaning the refrigerator .....	17	Power Interruptions .....	19
Vacation and moving care .....	18		

Your new refrigerator-freezer is designed to give you many years of dependable service. However, there are a few things you are expected to do in order to maintain your refrigerator-freezer properly. This section will tell you how to clean your refrigerator-freezer and how to care for it when you are going on vacation or moving.

## Cleaning the refrigerator

The refrigerator and freezer sections defrost automatically. However, both sections should be cleaned once a month to help prevent odors from building up. Spills should be wiped up immediately.

To clean the refrigerator, turn the Refrigerator Control to OFF, unplug the unit, take out all removable parts and clean the refrigerator according to the directions below.

**⚠ WARNING**

**Personal Injury Hazard**

Refrigeration system tubes are located above the defrost pan and can become hot. Remove and install defrost pan carefully.

Failure to do so could cause personal injury.

PART	WHAT TO USE	HOW TO CLEAN
<b>Exterior surfaces</b>	Sponge, soft cloth or paper towel with mild detergent and warm water Also, use an appliance wax or good auto paste wax	<ul style="list-style-type: none"> <li>Wash, rinse and dry well. <b>Do not use abrasive or harsh cleaners.</b></li> <li>Wax painted metal surfaces at least twice a year. Apply wax with a clean, soft cloth. Waxing painted metal surfaces provides rust protection. <b>Do not use wax on plastic parts.</b></li> </ul>
<b>Panels</b>		<ul style="list-style-type: none"> <li>Clean as you would your kitchen cabinets.</li> </ul>
<b>Base grille</b>	Vacuum cleaner with brush attachment	<ul style="list-style-type: none"> <li>Vacuum grille.</li> </ul>
<b>Removable parts</b> (shelves, meat locker, crisper, utility bin, etc.)	Sponge or soft cloth with mild detergent and warm water	<ul style="list-style-type: none"> <li>Wash, rinse and dry well.</li> </ul>

continued on next page

PART	WHAT TO USE	HOW TO CLEAN
Interior walls	Sponge, soft cloth or paper towel with mild detergent and warm water	• Wash, rinse and dry well.
Door liners and gaskets	Sponge, soft cloth or paper towel with mild detergent and warm water	• Wash, rinse and dry well. <b>Do not use cleaning waxes, concentrated detergents, bleaches, or cleaners containing petroleum or alcohol on plastic parts.</b>
Defrost pan	Sponge or cloth with mild detergent and warm water	• See page 14 for removal and replacement instructions. • Wash, rinse and dry well.
Condenser coils	Vacuum cleaner with extended narrow attachment	• Clean coils when dusty or dirty. Coils may need to be cleaned as often as every other month. • Remove base grille. (See page 14.) • Vacuum coils. • Replace base grille. (See page 14.)

## Vacation and moving care

### Short vacations

If you will be away for less than four weeks, there is no need to shut off the refrigerator. Use up perishables and freeze other items. If you have an automatic ice maker, turn off the automatic ice maker, then shut off the water supply to the ice maker. Empty the ice bin.

### Long vacations

Remove all food if you will be gone a month or more. If you have an automatic ice maker, turn off the water supply to the ice maker at least one day before you leave. When the last load of ice drops into the bin, turn the ice maker off. Turn the refrigerator-freezer off. (See "Setting the controls" on page 7.)

Unplug the refrigerator and clean it ... rinse well and dry. Tape rubber or wood blocks to the tops of both doors ... keeping them open far enough for air to get in. This will keep odor and mold from building up.

### WARNING

#### Personal Injury Hazard

Do not allow children to climb on, play near or crawl inside the refrigerator when the doors are blocked open.

They may become injured or trapped.

To restart the refrigerator, see "Setting the controls" on page 7.

## Moving

If you have an automatic ice maker, turn off the water supply to the ice maker at least one day before you move. When the last load of ice drops into the bin, turn the ice maker off by raising the signal arm. Empty the ice bin.

Remove all food and pack it in dry ice. Unplug the refrigerator and clean it thoroughly ... rinse well and dry. Take out all removable parts and tape them together so they won't rattle. Screw in the leveling legs, tape the door shut and tape the power supply cord to the cabinet.

When you get to your new home, put everything back and refer to page 5. Also, remember to reconnect the water supply line to the ice maker if you have one.

## Power interruptions

If electricity goes off, call the power company. Ask how long the power will be off.

1. If service is to be interrupted 24 hours or less, **keep both doors closed**. This will help foods stay frozen.
2. If service is to be interrupted longer than 24 hours:
  - (a) Remove all frozen food and store in a frozen food locker.

**OR**

  - (b) Place 2 lbs. (0.9 kg) of dry ice in freezer for every cubic foot of freezer space. This will keep food frozen for 2 to 4 days. Wear gloves to protect your hands from burns.

**OR**

  - (c) If neither a food locker nor dry ice is available, use or can perishable food at once.

3. A full freezer will stay cold longer than a partly filled one. A freezer full of meat will stay cold longer than a freezer full of baked goods. If food contains ice crystals, it may be safely refrozen, although the quality and flavor may be affected. If the condition of the food is poor, or if you feel it is unsafe, dispose of it.

## Questions?

Call our Consumer Assistance Center telephone number, 1-800-422-1230.

# Food Storage Guide

In This Section	Page	Page	
Storing fresh food .....	20	Storing frozen food .....	21

This section gives you helpful information on how to store all types of food and for how long. For more information, see a reliable cookbook or a freezer guide.

## Storing fresh food

### Vegetables

**Leafy:**

Remove store wrapping. Tear off bruised and discolored areas. Wash in cool water, drain. Place in plastic bag or container and store in crisper.

**With skins:**

Store in crisper or plastic bag.

### Fruit

**Berries:**

Sort to remove injured berries. Do not wash berries until they are to be served. Store in original container in crisper.

**Other:**

Sort to remove injured fruit before storing. Wash fruit, let dry, place in perforated plastic bag or loosely covered in plastic container and store in crisper.

### Eggs

Store in original carton. For best storage, place on interior shelf or in wine/egg rack.

### Dairy products

**Milk:**

Store in original container on refrigerator shelf.

**Butter or margarine:**

Store in the utility compartment or on refrigerator shelf until opened. When opened, store in covered dish or on butter dish in the utility compartment.

**Cheese:**

Store in original packaging until opened. When opened, tightly rewrap in plastic wrap or aluminum foil and store in utility compartment or on refrigerator shelf.

### Leftovers

Cover with plastic wrap or aluminum foil, or place in plastic containers with tight fitting lids.

### Condiments

Store small jars and bottles in door bins.

### Beverages

Wipe off bottles and cans. Store in door bins or on refrigerator shelf.

### Meat

**Cured or smoked meat and cold cuts:**

Store in original packaging until opened. When opened, tightly rewrap using plastic wrap or aluminum foil.

**Fresh, prepackaged meat and poultry:**

Store in original packaging.

**Fresh, not prepackaged:**

Remove market wrapping paper. Rewrap in plastic wrap.

**Cooked meat and poultry:**

Wrap or cover with plastic wrap or aluminum foil. Store immediately.

**Fresh fish and shellfish:**

Store in plastic bag or tightly covered container.

**Storage chart for meats\***

TYPE	APPROXIMATE TIME (DAYS)
Chicken	1 to 2
Ground beef	1 to 2
Variety meats	1 to 2
Steaks and roasts	3 to 5
Cold cuts	3 to 5
Bacon	5 to 7
Cured meat	7 to 10

\*If meat is to be stored longer than the time given, freezing is recommended.

**IMPORTANT:** Fresh fish and shellfish should be used the same day as purchased.

## Storing frozen food

### Prepackaged frozen food

Store in original packaging on freezer door shelf or on freezer shelf.

### Meat/poultry

Trim off excess fat and remove bones when necessary. Meat/poultry should not be salted. Wrap tightly in heavy-duty aluminum foil, plastic-coated paper or non-permeable plastic wraps (made out of a saran film). Press out as much air as possible. Label and date the meat/poultry. Do not refreeze thawed meat.

### Ice cream

Store in original packaging. When opened, place a piece of aluminum foil or waxed paper against ice cream surface to prevent the formation of ice crystals.

### Frozen juices

Store in original container on freezer door shelf or on freezer shelf.

**Storage chart for frozen food\***

TYPE	APPROXIMATE TIME (MONTHS)
Bread	2
Cooked dishes	2 to 3
Fresh fish/seafood	6
Frozen fish/seafood	1 to 3
Fruit	6
Ice cream	1
Concentrated juice	4 to 6
Bacon	less than 1
Pork roast/chops	3 to 4
Sausage	1 to 2
Beef/veal/lamb roasts	6
Ground meat	1 to 2
Poultry	3 to 4
Vegetables	6

\*Storage times given in this chart are only a guide. For best use of freezer space, keep frozen food for short times. Use, then replace as needed.

Courtesy of National Livestock & Meat Board and U.S.D.A.

# If You Need Assistance Or Service

If you ever have questions or comments about your appliance, you can call our toll-free Consumer Assistance Center telephone number, 1-800-422-1230, 24 hours a day.

This section is designed to help you save the cost of a service call. Part 1 of this section outlines possible problems, their causes, and actions you can take to solve each problem. Parts 2 and 3 tell you what to do if you still need assistance or service. When calling our Consumer Assistance Center for help or calling for service, please provide a detailed description of the problem, your appliance's complete model and serial numbers and the purchase or installation date. (See page 2.) This information will help us respond properly to your request.

## 1. Before calling for service ...

If your appliance should fail to operate, review the following list before calling your dealer. You could save the cost of a service call.

PROBLEM	CHECK IF	WHAT TO DO
<b>The refrigerator will not operate</b>	The power cord is not plugged into a live circuit with the proper voltage.	Plug the power cord into a live circuit with the proper voltage.
	A household fuse is blown or circuit breaker is tripped.	Change the fuse or reset the circuit breaker.
	The Refrigerator Control is in the OFF position.	Set Refrigerator Control to a setting other than OFF.
<b>The refrigerator makes unfamiliar sounds</b>		New features on your refrigerator make new sounds. See "Understanding the sounds you may hear" on page 16 for normal operating sounds.
<b>There is water in the defrost pan</b>		This is normal in hot, muggy weather. The pan can even be half full. Make sure the refrigerator is level so the pan will not overflow.
<b>Your optional ice maker will not operate</b>	The freezer has not had enough time to get cold.	Allow the refrigerator to reach the proper temperature. This could take 24 hours.
	The signal arm is OFF, in the up position.	Move the signal arm to the ON (down) position. (See page 13.)
	The water valve is not turned on.	Turn on the water line valve.
	Water is not getting to the ice maker.	Check water line for leaks or clogs.
<b>The lights are not working</b>	A household fuse is blown or circuit breaker is tripped.	Change the fuse or reset the circuit breaker.
	A light bulb is burned out.	See page 15 for instructions for changing the light bulbs.

PROBLEM	CHECK IF	WHAT TO DO
The motor seems to run too long	The room is too warm, too much food was put into refrigerator at one time or the doors have been opened too often.	The motor naturally runs longer on hot days or if the room is too warm, as well as when a large amount of food has been put into the refrigerator or the doors have been opened a lot.

**2. If the problem is not due to one of the items listed in step 1:**

- Call KitchenAid Consumer Assistance Center Toll-Free:  
**1-800-422-1230**  
and talk with one of our trained consultants. The consultant can instruct you in how to obtain satisfactory operation from your appliance or, if service is necessary, recommend a qualified service company in your area.
- If you prefer, write to:  
Consumer Assistance Center  
KitchenAid  
P.O. Box 558  
St. Joseph, MI 49085-0558  
Please include a daytime phone number in your correspondence.

**3. If you need service:**

- Call your dealer or the repair service he recommends.
- All service should be handled locally by the dealer from whom you purchased the unit or an authorized KitchenAid servicer.
- If you are unable to obtain the name of a local authorized KitchenAid servicer, call our Consumer Assistance Center telephone number (see step 2).

**4. If you are not satisfied with the action taken:**

- Contact the Major Appliance Consumer Action Panel (MACAP). MACAP is a group of consumer experts that voices consumer views at the highest levels of the major appliance industry.
- Contact MACAP only when the dealer, authorized servicer and KitchenAid have failed to resolve your problem.  
Major Appliance Consumer Action Panel  
20 North Wacker Drive  
Chicago, IL 60606
- MACAP will in turn inform us of your action.

# KitchenAid<sup>®</sup>

## Freestanding Refrigerator Warranty

LENGTH OF WARRANTY:	KITCHENAID WILL PAY FOR:	KITCHENAID WILL NOT PAY FOR:
<b>ONE YEAR FULL WARRANTY</b> FROM DATE OF PURCHASE.	Replacement parts and repair labor costs to correct defects in materials or workmanship. Service must be provided by an authorized KitchenAid servicing outlet.	<b>A. Service calls to:</b> 1. Correct the installation of the refrigerator. 2. Instruct you how to use the refrigerator. 3. Replace house fuses or correct house wiring. 4. Replace house plumbing. <b>B. Repairs when refrigerator is used in other than normal home use.</b> <b>C. Damage resulting from accident, alteration, misuse, abuse, improper installation or installation not in accordance with local electrical codes or plumbing codes.</b> <b>D. Any food loss due to product failure.</b> <b>E. Any labor costs during the limited warranty.</b> <b>F. Replace parts or repair labor costs for units operated outside the United States.</b> <b>G. Pickup and delivery. This product is designed to be repaired in the home.</b> <b>H. Repairs to parts or systems caused by unauthorized modifications made to the appliance.</b>
<b>SECOND THROUGH FIFTH YEAR FULL WARRANTY</b> FROM DATE OF PURCHASE.	Replacement or repair of the refrigerator/freezer cavity liner if the part cracks due to defective material or workmanship. Service must be provided by an authorized KitchenAid servicing outlet.  Replacement parts and repair labor costs to correct defects in materials or workmanship in the sealed refrigeration system. These parts are: 1. Compressor; 2. Evaporator; 3. Condenser; 4. Drier; 5. Connecting Tubing. Service must be provided by an authorized KitchenAid servicing outlet.	
<b>SIXTH THROUGH TENTH YEAR LIMITED WARRANTY</b> FROM DATE OF PURCHASE.	Replacement parts to correct defects in materials or workmanship in the sealed refrigeration system. These parts are: 1. Compressor; 2. Evaporator; 3. Condenser; 4. Drier; 5. Connecting Tubing.	

**KITCHENAID DOES NOT ASSUME ANY RESPONSIBILITY FOR INCIDENTAL OR CONSEQUENTIAL DAMAGES.** Some states do not allow the exclusion or limitation of incidental or consequential damages, so this exclusion may not apply to you.

This warranty gives you specific legal rights and you may also have other rights which may vary from state to state.

If you need service, first see the "Assistance or Service" section of this book. After checking "Assistance or Service," additional help can be found by calling our Consumer Assistance Center telephone number, 1-800-422-1230, from anywhere in the U.S.

KitchenAid  
 St. Joseph, Michigan, U.S.A. 49085



Printed on recycled paper

**Part No. 2161911 Rev. A**

© 1992 KitchenAid

® Registered Trademark / TM Trademark of KitchenAid

Printed in U.S.A.