

Hotpoint Service and Spares

FOR SERVICE: If you have a problem with your appliance ring your local Service Office.
FOR SPARES and ACCESSORIES: To purchase spares and accessories send your Accessories Order Form to your Spares Centre. If the accessory or spare part you want is not on the form, contact your Spares Centre for prices and availability.

Please address all correspondence to Hotpoint Spares Centre or Hotpoint Service Office as applicable.

Service Offices and Spares Centres are open between 8.00am-5.00pm Monday to Friday, except on Public Holidays. 8.30am-12.30pm on Saturdays.

- Service Office and Spares Centre
- Service Office only

EAST
● ESSEX: Industrial Buildings, Beehive Lane, Chelmsford, CM2 9TE
 Post Codes RM & IG Tel: (0246) 492433
 Remainder of Essex Tel: (0246) 263531

■ **PETERBOROUGH:** Cella Road, PE2 9UB Tel: (0733) 64741
 For Spares Spares Administration Dept. Tel: (0733) 566620

■ **LONDON**
 For Service: 68 East Lane, HA9 7PU Tel: 081-904 4399
 S. Herts and Middlesex Post Codes N, NW, E, EC Tel: 081-908 4722
 Post Codes W, WC, SE, SW Tel: 081-908 2511
 Tel: 081-904 0201

For Spares
MIDLANDS
 ■ **BIRMINGHAM:** Westgate, Aldridge, W Midlands, WS9 8UX.
 Post Codes B Tel: (0922) 743374
 All other Post Codes Tel: (0922) 743376
 Tel: (0922) 743377

For Spares
 ■ **NOTTINGHAM:** Ashling Street, NG2 3JB
 Tel: (0602) 862431/864322 For Spares Tel: (0602) 860387
 West Ave, Nelson Estate, Table, S17 1TN, Tel: (0782) 774511

■ **STOKE:** 8 Belle House, Tower Road, Glover Est, District 11, NE37 2SH
 Tel: 091-417-3500/419-3535
 Sandbeck Lane, LS22 4TW
 Tel: (0937) 581261/581444 For Spares Tel: (0937) 581221

■ **WETHERBY:** Manorford House, 26 Highgate, LA9 4SX, Tel: (0539) 724483
 For Service: 4446 Station Road, Heaton Mersey, Stockport, SK4 30T.
 Manchester North Tel: 061-432 0513
 Manchester South Tel: 061-442 8677
 Tel: 061-432 0235
 7 Bridle Way, Merseyside, Tel: 051-525-2342/524-2339

■ **NORTH WEST**
 ● **KENAL:** Holbeck House, 68 Carden Place, AB1 1UL, Tel: (0224) 642283
 4446 Station Road, Heaton Mersey, Stockport, SK4 30T.
 Manchester North Tel: 061-432 0513
 Manchester South Tel: 061-442 8677
 Tel: 061-432 0235
 7 Bridle Way, Merseyside, Tel: 051-525-2342/524-2339

■ **MANCHESTER:** West Lodge Road, Blymswood Estate, P44 9EN
 Tel: 0941-866 6241 For Spares Tel: 0941-866 5611

■ **SCOTLAND**
 ● **ABERDEEN:** Larkfield Tradon Est, New Hyde Lane, Larkfield, ME20 6SW,
 CT, DA, ME & TN Kent Post Codes Tel: (0622) 716571
 CR, KT, RH, SW Surrey & BR Kent Post Codes (0622) 790707
 GU Post Codes in Surrey Tel Southampton (0703) 667374
 Tel: (0622) 716631

● **EDINBURGH:** Unit R, S Hampshire Ind Park, Salisbury Rd, Tolon, SO40 3SA
 Tel: (0703) 861981/867374 For Spares Tel: (0703) 867933
 1 Kingswood, North St, Halesham, BN27 1DQ, Tel: (0323) 842733
 69 Mulvey Plain, PL4 6LH, Tel: (0752) 262631

■ **RENFREW:** Conwy Rd, Llandudno Junction, LL31 9RE, Tel: (0492) 573536
 18 Western Ave, Bridgend Ind Estate, Bridgend, CF31 3SL,
 Post Codes SA, GL (not SA), HR, SV15-18, LD-1-8, NP, Tel: (0656) 665554
 Tel: (0656) 766111

■ **SOUTH**
 ● **KENT:** Larkfield Tradon Est, New Hyde Lane, Larkfield, ME20 6SW,
 CT, DA, ME & TN Kent Post Codes Tel: (0622) 716571
 CR, KT, RH, SW Surrey & BR Kent Post Codes (0622) 790707
 GU Post Codes in Surrey Tel Southampton (0703) 667374
 Tel: (0622) 716631

■ **SOUTHAMPTON:** Unit R, S Hampshire Ind Park, Salisbury Rd, Tolon, SO40 3SA
 Tel: (0703) 861981/867374 For Spares Tel: (0703) 867933
 1 Kingswood, North St, Halesham, BN27 1DQ, Tel: (0323) 842733
 69 Mulvey Plain, PL4 6LH, Tel: (0752) 262631

■ **SUSSEX:** Conwy Rd, Llandudno Junction, LL31 9RE, Tel: (0492) 573536
 18 Western Ave, Bridgend Ind Estate, Bridgend, CF31 3SL,
 Post Codes SA, GL (not SA), HR, SV15-18, LD-1-8, NP, Tel: (0656) 665554
 Tel: (0656) 766111

■ **WALES**
 ● **NORTH:** Conwy Rd, Llandudno Junction, LL31 9RE, Tel: (0492) 573536
 18 Western Ave, Bridgend Ind Estate, Bridgend, CF31 3SL,
 Post Codes SA, GL (not SA), HR, SV15-18, LD-1-8, NP, Tel: (0656) 665554
 Tel: (0656) 766111

IRELAND
 ● **NORTHERN:** 256 Ormeau Road,
 Belfast, BT7 2FZ
 Tel: (0222) 647111
 49 Altways Ind Estate,
 Dublin 17
 Tel: Dublin 426088
 Tel: Dublin 426336
 For Service
 For Spares

■ **EIRE:** Dublin 17
 Tel: Dublin 426088
 Tel: Dublin 426336

CHANNEL ISLANDS – Service provided by Agents.
 Normal Guarantees apply and all Service Schemes are available.
JERSEY: 19 Don Street, St. Helier.
 Tel: (0534) 21625
 Clos D'Ormes, Ponthé,
 St Clements, Tel: (0534) 54808
GUERNSEY & SARRE: Valleys Stores, Grande Rue, St Martins,
 Guernsey, Tel: (0481) 38422
 or
 Barris Lane, Vale
 Tel: (0481) 51610
 32 High Street,
 Tel: (0481) 822686

ALDERNEY: 32 High Street,
 Tel: (0481) 822686

ISLE OF MAN – Service provided by Agents.
 Normal Guarantees apply and all Service Schemes are available
 from
 5 Dringold St., Douglas.
 Tel: (0624) 673233
 or
 Tromode Works,
 Cronkbourne Village, Douglas,
 Tel: (0624) 676066
 17 Ridgeway Street, Douglas,
 Tel: (0624) 25811/25848

SHEETLAND, ORKNEY & WESTERN ISLES –
 Service provided by Agents. Normal Guarantees apply, but
 Service Schemes are NOT available.
SHEETLAND: Fort Road, Lerwick
 Tel: (0595) 2557
ORKNEYS: Halstone Ind Estate, Kirkwall,
 Tel: (0856) 5467
WESTERN ISLES: 27 Bayhead Street,
 Stromness, Isle of Lewis
 Tel: (0851) 3387
OTHER ISLANDS: Local Hydro Electric Shops.
EXCEPT ARRAN, BUTE & SKYE –
 Which are covered by Hotpoint.

HOTPOINT HANDBOOK

FRIDGE FREEZERS

MODELS 8332, 8329

AND 8362

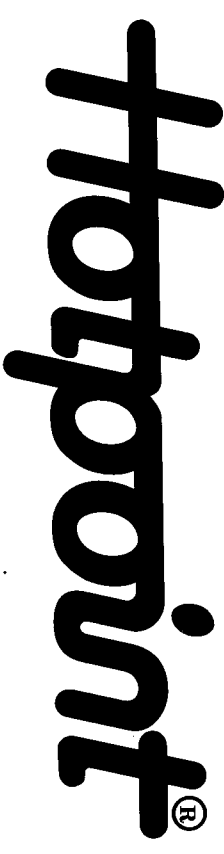

Your new Hotpoint Fridge Freezer

Using your new fridge freezer is very simple. Nevertheless, for your own safety and to get the best results it is important that you read right through this handbook **before** using your fridge freezer for the first time. Do not load the freezer compartment immediately the fridge freezer is switched on, but wait until the correct storage temperature has been reached (see page 9).

Electrical Requirements

We recommend that this appliance is connected to the mains supply via a suitable switched socket in a readily accessible position.

All Hotpoint appliances come complete with a fitted plug. The plug on your fridge freezer has a 13A fuse. If the plug does not fit your sockets, a new plug can be fitted. Cut off the old plug and throw it away, do not insert it into a socket elsewhere in the house as this could cause a shock hazard.

WARNING: THIS APPLIANCE MUST BE EARTHED.

IMPORTANT: Fitting a Different Plug:

The wires in the mains lead are coloured in accordance with the following code:

Green and Yellow	– Earth
Blue	– Neutral
Brown	– Live

If you fit your own plug the colours of these wires may not correspond with the identifying marks on the plug terminals. This is what you have to do:

1. Connect the green and yellow (Earth) wire to the terminal in the plug marked 'E' or with the symbol \oplus , or coloured green or green and yellow.
2. Connect the blue (Neutral) wire to the terminal in the plug marked 'N' or coloured black.
3. Connect the brown (Live) wire to the terminal marked 'L' or coloured red.

With alternative plugs a 5A fuse must be fitted either in the plug or adaptor or in the main fuse box. In the event of replacing a fuse in the plug supplied, a 13A ASTA approved fuse to BS1362 must be fitted.

If the plug is the moulded on type the fuse cover must be refitted when changing the fuse. In the event of losing the fuse cover the plug must **not** be used until a replacement fuse cover has been obtained and fitted. A new fuse cover can be obtained from your nearest Hotpoint Spares Centre or local Electricity Company. The colour of the correct replacement fuse cover is that of the coloured marks or insert in the base of the plug.

Mains Lead Replacement

If the mains lead on this appliance needs replacing at any time, it must be replaced by a special lead which is obtainable from your nearest Hotpoint Service Office (see back page). A charge will be made for the replacement of the mains lead if you have damaged the lead or require a longer lead.

WARNING:

HOW TO AVOID ACCIDENTS TO CHILDREN. WHEN DISCARDING AN OLD FRIDGE OR FREEZER BE CERTAIN TO MAKE THE LOCK UNUSABLE. IF POSSIBLE, REMOVE THE DOORS AND DISCARD SEPARATELY.

DO NOT ATTEMPT TO STAND ON TOP OF YOUR APPLIANCE. IT IS NOT DESIGNED FOR SUCH USE AND YOU COULD INJURE YOURSELF OR DAMAGE THE APPLIANCE BY SUCH ABUSE.

CHILDREN SHOULD NOT BE ALLOWED TO PLAY WITH THE APPLIANCE OR TAMPER WITH THE CONTROLS.

Hotpoint Service Cover

Satisfaction Guaranteed or Your Money Back

Hotpoint gives you a unique 'Satisfaction Guaranteed' promise – valid for ninety days after you have purchased your Hotpoint product. If there is a problem with your Hotpoint appliance just call your Hotpoint Service Office. If necessary we will arrange for an engineer to call. If the problem is not resolved by us under this Guarantee, Hotpoint will replace your appliance or, if you prefer, give you your money back. This Guarantee is additional and subject to the terms of Hotpoint's Five Year Parts Guarantee.

Hotpoint's Free Five Year Guarantee

From the moment your appliance is delivered, Hotpoint guarantees it for **FIVE YEARS**.

- In the Five Years all replacement parts are **FREE** provided they are fitted by our own Service Engineer. During the first year our Engineer's time and labour is also free. Our Guarantee also covers loss of food in our Refrigeration and Freezer products up to £250 during the first year.
- After the first year we will charge for our Engineer's time and labour. We do, however, operate a range of Service Plans (see opposite) which for an annual payment enables you to cover any repair costs which may be necessary.
- All our service repairs are guaranteed for twelve months in respect of our labour and any parts fitted.
- The appliance must be used in the United Kingdom and must not be tampered with or taken apart by anyone other than our own Service Engineer.
- You may, however, buy parts which can be safely fitted without specialist knowledge or equipment. The correct fitting of such parts, provided they are genuine Hotpoint spares, will not affect your Guarantee. Parts are available from our main Hotpoint Spares Centres (see back page).
- Our Guarantee does not cover the cost of any repair which is needed because of power cuts, accidents or misuse. Nor does it cover the cost of any visit to advise you on the use of the appliance. Please read the instruction book thoroughly.
- If at any time during the Guarantee period we are unable to repair your appliance, we will refund any repair costs paid to us in the previous twelve months. We will also offer you a new appliance at a reduced charge instead of a repair.
- Our Guarantee is in addition to and does not affect your legal rights.
- Should you need independent advice on your consumer rights, help is available from your Consumer Advice Centre, Law Centre, Trading Standards Department and Citizens Advice Bureau.

- All Hotpoint servicing is done by our own Service Organisation located throughout the United Kingdom and Southern Ireland. It will be happy to deal with any problems.

Hotpoint's Service Care

Whether you have just one or a number of Hotpoint appliances in your kitchen Hotpoint has a range of Service Schemes to give you complete peace of mind.

Service Cover

A single payment covers you for all repairs during the period of cover, which can be from 1 to 4 years. There is also an option of Service Cover with Maintenance at an additional cost. This includes an annual Electrical and Safety check and replacement of any parts as necessary. For 1 year contracts this takes place towards the end of the contract period.

Kitchen Cover

An annual payment covers you for all repairs for all your Hotpoint appliances which are less than ten years old. It also covers the cost of loss of food up to £250 in our refrigeration and freezer products. There is also an option of Kitchen Cover with Maintenance at an additional cost. Any additional Hotpoint appliances purchased after you have joined Hotpoint Kitchen Cover will automatically be included during the annual period of cover without further charge.

Appliance Registration

To ensure that you have the opportunity to benefit from any of the above Service Schemes you should complete and return immediately the Appliance Registration Form supplied with your appliance. Full details and costs of our Service Schemes together with an application form will be sent to you at the end of the first year of the guarantee.

Annual Safety/Maintenance Checks

Hotpoint strongly recommends that all its appliances are regularly checked for electrical and mechanical safety whether or not they are covered by a Service Plan.

Proof of Purchase

For future reference please attach your purchase receipt to this booklet and keep it in a safe place.

Spares and Accessories

Spares and accessories can be ordered from your local Hotpoint Spares Centre (listed on the back page), using the order form enclosed.

NOTE: Our Engineer will use every effort to avoid damage to floor coverings and adjacent units when carrying out repairs/service work but in locations where the Engineer advises you that it will be impossible to move the appliance without risk of damage, he will only proceed with your approval that no liability is accepted.

Contents

THIS BOOK COVERS MODELS 8332, 8329 AND 8362

15. Using the two fixing screws secure the centre hinge to the cabinet.
 16. Refit the bottom door sliding it upwards locating the centre hinge in the door hinge bush.
 17. Fit the bottom hinge (and spacing washers) into the bottom hinge bush, adjusting the door so that it fits evenly with the cabinet sides.
 18. Using the two fixing screws secure the bottom hinge to the cabinet.
 19. Replace the adjustable front feet, setting them 36mm from the bottom of the cabinet to the bottom of the foot.
 20. Carefully stand your fridge freezer upright (you may need assistance for this) in the required location. Adjust the front feet until all four feet are in firm contact with the floor and the fridge freezer does not rock. **(See Installing Your Fridge Freezer).**
 21. Check the doors open and close freely. Ensure door seal is seated evenly around the cabinet.
 22. Finally put back all the loose items/fitings.
 23. The fridge freezer must be stood upright for at least 15 minutes before being switched on.
- NOTE:** If difficulties are encountered, contact your local Service Office.

Get to know your Fridge Freezer

Installing your Fridge Freezer

Where to put your fridge freezer
Fitting decor panels to match your kitchen units

Page
4-5
5-6

Getting your Fridge Freezer ready for use

Starting and Running In

7

Controlling the Temperature

8

Storing Food

Storing food in the fridge compartment
Storing frozen food in the freezer compartment
Freezing fresh foods – maximum freezing loads and how to freeze them
Do's and Don'ts

9-12

Caring for your Fridge Freezer

Defrosting
Cleaning
Going Away
Replacing the interior light

13-15

If your Fridge Freezer won't work

Repositioning the door hinges
Hotpoint Service Cover

16-19

Hotpoint Service Offices and Spares Centres

Back Page

Retention of the Instruction Book

This Instruction Book must be kept handy for reference as it contains important details on the safe and proper use of the appliance.

If you sell or pass the appliance to someone else, or move house and leave it behind, make sure this Book is also provided so the new owner can become familiar with the appliance and safety warnings.

If the Book is lost or damaged a copy may be obtained from Hotpoint Ltd, Celta Road, Peterborough, PE2 9JB.

Get to know your Fridge Freezer

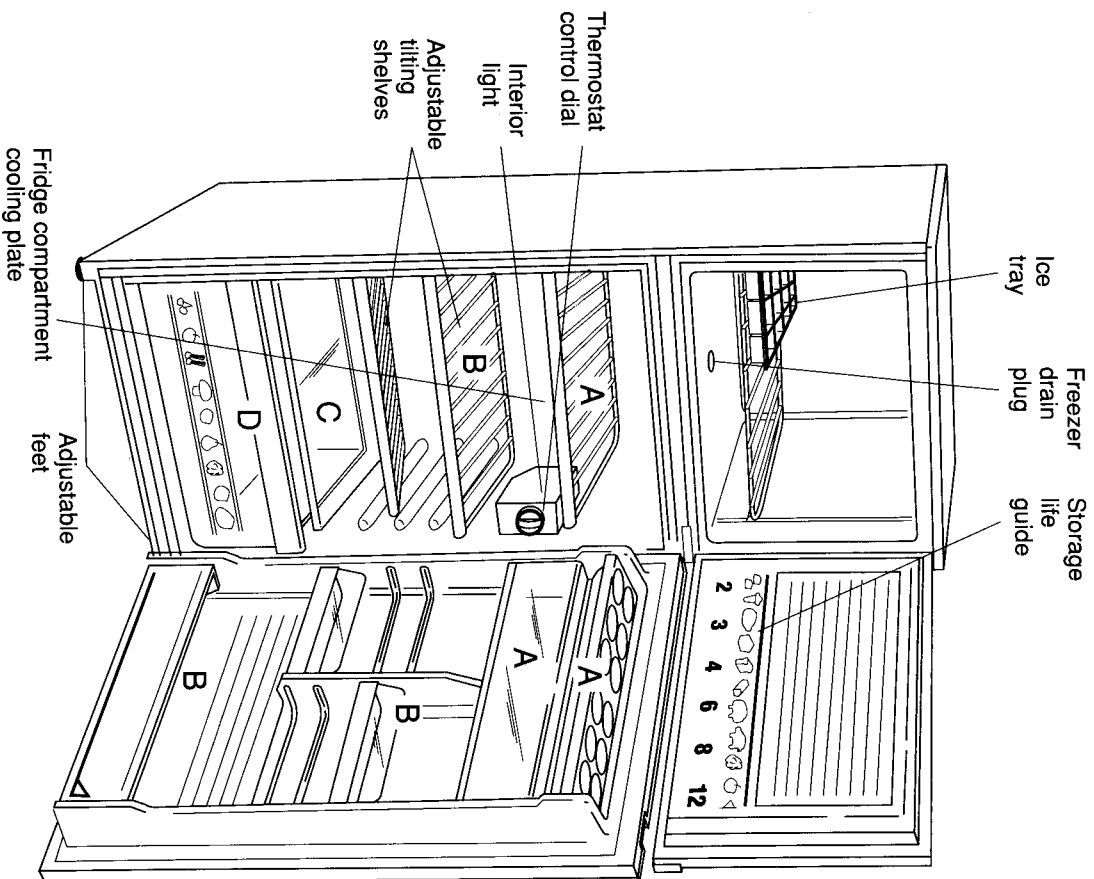

Model 8332 (Models 8329 and 8362 are similar)

Repositioning the door hinges

Just follow the step by step instructions below:

Tools Required: A 7mm/8mm A/F Spanner or a No. 2 Pozidriv.

1. Remove all loose items/fittings from inside the fridge freezer.
2. **Carefully** lay the fridge freezer on its back (you may need a second person to support the fridge freezer). **Take care to avoid damage to the pipework by keeping it clear of the floor or by laying it on some protective material (eg. its original packaging).**
3. Unscrew and remove the two front feet.
4. Unscrew and remove the bottom hinge. Ensure any spacing washers fitted, and the fixing screws, are kept with the hinge.
5. Remove the lower door by gently pulling it downwards. Stand the door carefully to one side.
6. Unscrew and remove the centre hinge, ensuring any spacing washers fitted, are kept with the hinge and screws.
7. Remove the top door and stand the door carefully to one side.
8. Unscrew and remove the top hinge, then replace the screws.
9. Remove the two hinge fixing screws on the top left hand side and use them to refit the top hinge.
10. Remove the plate from the front/bottom left hand side of the cabinet and refit on the right hand side where the bottom hinge was.

11. Prise off the screw covers on the centre left hand side (using a thin blunt instrument). Remove the screws and cup washers and refit on the right hand side.

12. Preparing the door for change over.

- a) Remove the top and bottom hinge bushes and the blanking plug, with a thin blunt instrument taking care not to mark the handle. Reposition on the opposite side.
- b) Unscrew and remove the handle insert and replace the screws. Refit the insert with the screws from the left hand side.

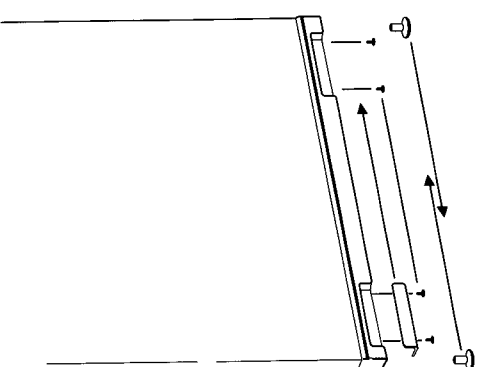

13. Refit the top door, sliding it upwards, locating the top hinge pin in the door hinge bush.
14. Fit the centre hinge (and spacing washers) into the bottom hinge bush of the top door, positioning the door so that it fits evenly with the cabinet sides.

If your Fridge Freezer

won't work

... don't panic

Just run through these quick checks before calling your nearest Hotpoint Service Office.

1. Check that the plug is firmly in the wall outlet socket and that the power supply is on.
2. Check the power supply to the socket by plugging in another appliance.
3. If the other appliance works, check the fuse in the fridge freezer plug.
4. If you have changed the plug, check the wiring (see page 2).
5. If there is excessive noise or vibration, check that all four feet are firmly in contact with the ground (see page 5).
6. If the interior light fails to work, refer to page 17 for further instructions.
7. If water appears down the inside back of the fridge compartment, check that the gutter drain hole has not become blocked and that there is nothing touching the cooling plate. (NB Water droplets on the cooling plate are quite normal.)
8. If water droplets appear on the outside of the cabinet when the room is cold or humid or you are freezing fresh foods, this is quite normal (see pages 10 and 12). If, after following all these instructions, you are still having problems, contact your nearest Hotpoint Service Office (or local importer if outside the United Kingdom). The telephone number is shown on the back page.

1. Your name, address and post code.
2. Your telephone number.
3. Clear and concise details of the fault.
4. The model number (8332, 8329 or 8362), the serial number (found on the label on the underside of the front top of the appliance) and colour.
5. When it was purchased. Please put the date here
6. If you have subscribed to the Hotpoint Service Cover Plan (see opposite page). Make sure you have all these details before you call.

Spare Parts

Please remember your new appliance is a complex piece of equipment.

'DIY' repairs or unqualified and untrained service people may put you in danger, could damage the appliance and might mean you lose cover under Hotpoint's Parts Guarantee.

If you do experience a problem with the appliance don't take risks; call in

Hotpoint's own Service Engineer.

The address and telephone number of your nearest Hotpoint Service Office is in your local telephone directory.

Our spare parts are designed exclusively to fit only Hotpoint appliances. Do not use them for any other purpose as you may create a safety hazard.

Installing your Fridge Freezer

Where to put your fridge freezer

Your fridge freezer should be placed where it is easy to use, alongside a work surface is often a good position. Avoid putting it near anything which gives off heat, a cooker or radiator for example. In such a position your fridge freezer will have to work harder and will cost more to run and may also be damaged by the heat. Do not put your fridge freezer in a very cold room where the temperature goes below 6°C (43°F) for prolonged periods. In such a position the freezer compartment will run warmer and the storage time of frozen food may be reduced.

Once you have decided on the most suitable place, fit the two wall spacers supplied to the top of the condenser using the correct slot in the spacer for your particular type of condenser – your fridge freezer is fitted with one of two alternative condensers (a) or (b) as shown below. Push the fridge freezer back until the spacers are against the wall. This automatically ensures adequate air circulation at the back of the fridge freezer.

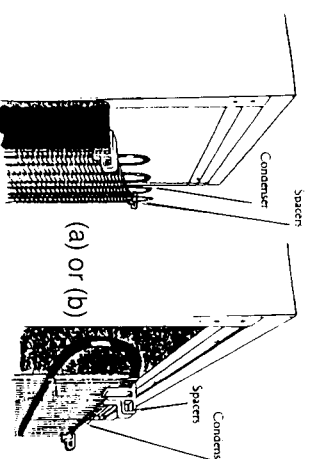

If your fridge freezer is placed underneath any wall cupboards, make sure that there is a gap of at least 100mm (4in) between the top of the fridge freezer and the underside of the cupboards. Finally, make sure your fridge freezer is standing correctly by carefully adjusting the two front feet by turning them clockwise or anti-clockwise, until all four feet are in firm contact with the floor. Correct adjustment avoids excessive vibration and noise.

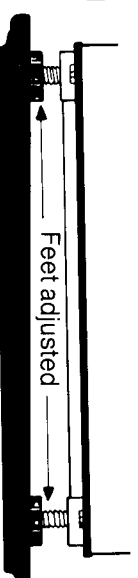

A Wheel Kit, Part No. 8031, for fitting to the back of your fridge freezer, is available from your retailer or nearest Hotpoint Spares Centre using the Accessories Order Form supplied.

Fitting decor panels to match your kitchen units

For that fully co-ordinated kitchen look it is possible to fit matching decor panels to your fridge freezer. Special trim kits are available from Hotpoint that attach to the edges of the appliance doors and enable decor panels, up to 4mm (1/8in) thick, to be fitted. Decor panels are available from most kitchen suppliers.

Each door requires a separate trim kit:

Top door requires trim kit Part No. 8003 (Brown) or Part No. 8006 (White)

Bottom door requires trim kit Part No. 8002 (Brown) or Part No. 8005 (White)

These are available from your retailer

or nearest Hotpoint Spares Centre (see back page) using the Accessories Order Form supplied with your Fridge-Freezer.

Commodity rack adjustment

The commodity racks have been designed to be adjustable which enables you to make maximum use of the storage capacity of the inner door. To remove the commodity rack simply lift the front of the rack to release it from the fixing groove in the door liner. To replace the rack tilt the back of the rack and push it into the preferred fixing position (see diagram below). Ensure that the rack is securely fixed before loading by applying light downward pressure to the front of the rack.

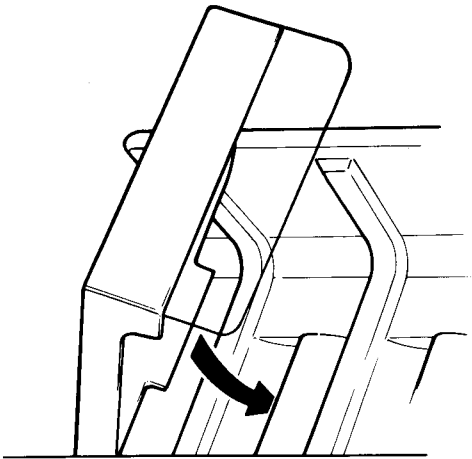

Adjustable/tilting shelves

The shelving system in the fridge interior has also been designed to provide maximum storage flexibility. It is possible to position the shelves at various heights to suit the items being stored and it is also possible to tilt certain shelves thereby allowing safe storage of bottles and jars on their sides. To tilt a shelf place the shelf hanger (A) at the back of the shelf on a lower level as the main body of the shelf (B) (see diagram below).

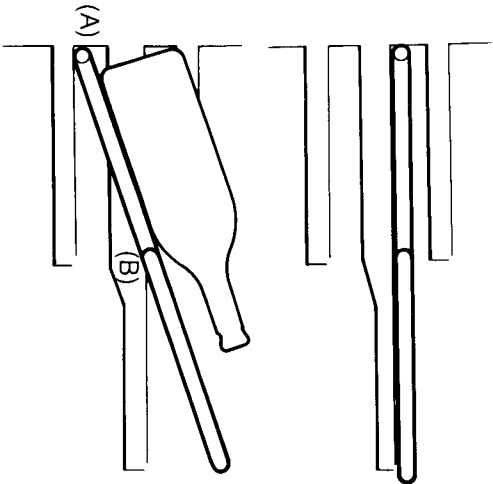

Going away

If you expect to be away for any length of time and don't want to use your fridge freezer, switch off at the mains outlet socket and pull out the plug. Remove all food and follow the defrosting instructions (see pages 15 and 16). After defrosting dry out the interior. Always leave both doors ajar to prevent the accumulation of odours.

How to replace the interior light

Should the light fail to work, **switch off and pull out the mains plug**, then ensure the bulb is screwed securely into the bulb holder.

Replace the plug and switch on. If the light still fails to work, do not worry, it will not affect the working of your fridge freezer. Obtain a replacement SES 15 Watt bulb from a local electrical retailer or your nearest Hotpoint Spares Centre and then fit it as follows:

1. **Switch off and pull out the mains plug.**
2. Remove the wire shelves to make access easier.
3. Slacken off the lamp guard, undoing the pozidrive retaining screw by one turn.
4. Unclip and remove the lamp guard.
5. Unscrew the old bulb and fit the new one.
6. Refit the lamp guard, ensuring that the two legs opposite the retaining screw fit into the holes.
7. Retighten the retaining screw.
8. Replace the plug and switch on.

Caring for your Fridge Freezer (cont.)

Cleaning your fridge freezer

It is a good idea to clean the inside of your fridge freezer after defrosting. Always **switch off and pull out the mains plug** first. Wipe out the inside of the fridge freezer using a clean cloth wrung out in either a solution of one teaspoonful of bicarbonate of soda to one pint of water or Milton diluted according to the manufacturer's instructions. The complete interior including the door, and removable parts, should be washed. The commodity and bottle racks and ice cube tray can be washed on the top rack of the dishwasher, selecting a low temperature programme. **Never** use any household cleaner or detergent, abrasive powders or wax polish. These not only damage the surfaces, but also leave a smell in the fridge freezer. Make sure that no particles of food are left in the gutter in the fridge compartment. Before you refill the fridge freezer ensure it is thoroughly dry.

Clean the outside of the fridge freezer, **but not the door seal**, with a damp cloth, using a small amount of detergent, followed by a wipe down with a clean cloth. Do not use an abrasive powder. **The rubber door seal must be cleaned with soap and water only as detergent will damage it.**

Finally, the compressor and condenser at the back of the fridge freezer can be carefully cleaned. Use a brush or vacuum cleaner to remove any dust. Always check that the fridge freezer is disconnected from the mains when doing this. Remember to replace the mains plug and switch on after cleaning your fridge freezer.

Getting your Fridge Freezer ready for use

Before using your fridge freezer for the first time the interior, including the door, and all removable parts should be wiped out. Use a damp cloth wrung out in either a solution of one teaspoonful of bicarbonate of soda to one pint of water or Milton diluted according to the manufacturer's instructions.

WARNING: NEVER USE ANY HOUSEHOLD CLEANER OR DETERGENT, ABRASIVE POWDERS OR WAX POLISH. THESE NOT ONLY DAMAGE THE SURFACES, THEY ALSO LEAVE A SMELL IN THE FRIDGE FREEZER.

Final check

Before you start using the fridge freezer, check that

1. it is thoroughly dry inside,
2. the interior air can circulate freely,
3. the feet have been adjusted, ie. all four are firmly on the ground.

Starting

Insert the plug into the outlet socket and switch on the electricity supply. Open the fridge compartment door and the light will come on. There is a control dial on the right hand side of the interior. Turning the dial clockwise from 'O' (off) will start the fridge compartment working. You will hear a noise as the compressor starts up.

Note: Your fridge freezer is designed only for domestic purposes, for the freezing and storage of food.

If you are going to store already frozen food allow at least two hours for the freezer compartment to reach the necessary storage temperature before you put in the frozen food. If you are going to freeze fresh food **wait at least three hours** before putting in your fresh food to be frozen. Do not put more than 4.0kg (8.8lb) of fresh food to be frozen in the freezer compartment (see page 12).

Running-in the compressor

The liquid and gases sealed within the refrigeration system may give rise to slight noise, whether the compressor is running or not. This is quite normal. Your fridge freezer is operated by a compressor which switches on and off in order to maintain the fridge freezer's temperature. The compressor is a precision piece of machinery and, like a car engine, requires a running-in period of up to 2 months. During this time the compressor has to work a little harder and this may result in more noise than usual.

Controlling the Temperature

The temperature inside your refrigerator should be 5°C or less, though some sections such as the Salad Bin will be warmer. Frequent door openings cause higher temperatures inside.

We recommend using a thermometer to check the temperature, it should be left overnight on the centre of the middle shelf and in a position where it can be viewed without moving it and read immediately the door is initially opened the following morning. If the temperature reading is not between 0°C and 5°C then the controls should be adjusted (see below), or defrosting may be required.

A fridge/freezer thermometer Part No. 8058 is available to ensure that you maintain your appliance at the correct temperature. This can be ordered from your local Hotpoint Spares Centre (see back page) using the order form enclosed.

WARNING: DO NOT USE MERCURY FILLED THERMOMETER.

The control dial, on the right-hand side of the fridge compartment interior, controls the temperature inside the fridge compartment and maintains the freezer compartment at the correct temperature. It is marked 'O' (off), 1, 2, 3 ... 9. Which setting is selected will depend on where the fridge freezer is located, how often you open the door and the room temperature.

A control setting of 5-6 is usually suitable, but if you find the interior of the fridge compartment is too warm turn the control clockwise to a colder setting (higher number). Similarly, if you find the interior is too cold, turn the control anti-clockwise to a warmer setting (lower number). With

a suitable fridge compartment temperature the freezer compartment will automatically be maintained at the correct temperature necessary for

*** frozen food storage (see Storing Food in your freezer compartment – pages 11 & 12).

If the room is cold or humid, water droplets may form on the outside of the fridge freezer. If this happens do not worry as they will disappear when conditions return to normal. Turning the control dial inside the fridge compartment to a lower number will also help to get rid of them.

In the summer months, or in conditions giving high temperatures around the fridge freezer the compressor has to work harder and run for longer periods. This is quite normal. Conversely, during cold weather the compressor will run for much shorter periods.

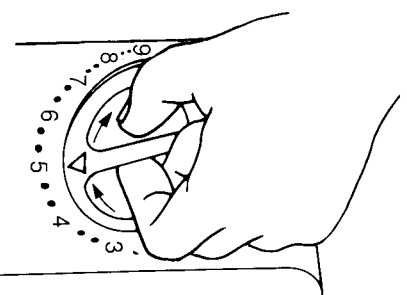

Caring for your Fridge Freezer

Defrosting

The fridge compartment

The fridge compartment will **automatically** defrost itself and the defrost water will drain out through the hole in the gutter and into a special container where it evaporates. Water droplets will form on the cooling plate during the defrost periods and will freeze on the plate afterwards. If your kitchen becomes exceptionally warm the cooling plate may not defrost regularly. Do not worry. Periodic defrosting will begin again when conditions return to normal. Do make sure that the gutter is always kept clear and that stored food does not come into contact with the cooling plate.

The freezer compartment

Frost forms on the cold surfaces from the moisture in the air and improperly wrapped food. The frost will build up first on the roof of the compartment, towards the front, this is normal. From time to time remove the frost from this, and other frosted surfaces, using the plastic scraper provided. **Never** use sharp metal tools to remove the frost – they could damage your freezer beyond repair. Periodically you will need to fully defrost your freezer, how often will be dependent on usage. Try to defrost when there is little or no food in the freezer compartment. Defrosting must be carried out as quickly as possible since a rise in the temperature of your frozen food may reduce the recommended storage time. Just follow these steps:

1. Switch off and pull out the mains plug.

2. Remove any frozen food. Wrap it in several layers of newspaper or a blanket and put it in the fridge compartment or a cool place.
3. Remove the Ice Tray.
4. Place bowls of hot water (**Do not** use any other source of heat) in the freezer compartment taking care not to cover the freezer drain.
5. Open the fridge compartment door and pull out the freezer drain plug and put it somewhere safe.
6. Put a suitable container on the top shelf of the fridge compartment underneath the freezer drain to collect the freezer defrost water.
7. As soon as the frost begins to melt use the plastic scraper to remove the ice.
8. After defrosting remove the bowls and dry the interior thoroughly.
9. Remove the container of defrost water from the fridge compartment and put the drain plug back.
10. Replace the mains plug and switch on.
11. Refill the Ice Tray and replace.
12. Job done!

Do's and Don'ts (cont.)

Freezer compartment

- Do:-** Always choose high quality fresh food and be sure it is thoroughly clean before you freeze it.
- Do:-** Prepare fresh food for freezing in small portions to ensure rapid freezing.
- Do:-** Remember lean foods last longer than fat foods and salt will reduce storage life.
- Do:-** Wrap all foods in aluminium foil or freezer quality polythene bags and make sure any air is excluded. Keep the door shut when freezing fresh food.
- Do:-** Wrap frozen food when you buy it and put it into the freezer compartment as soon as possible.
- Do:-** Empty and refill the Ice Tray periodically to ensure freshness.
- Do:-** Store commercially frozen food in accordance with the instructions given on the packets that you buy.
- Do:-** Defrost the freezer compartment before the ice becomes thick (see pages 15 and 16).
- Do:-** Ensure frozen foods are thoroughly defrosted before cooking unless the instructions on the packet say different.
- Do:-** Ice cream should be removed from the freezer 15-30 minutes before serving.

Don't:-

- Exceed the maximum freezing loads when freezing fresh food (see page 13).
- Don't:-** Put hot food into the freezer or even in the fridge compartment. Let it cool down first.
- Don't:-** Leave the door open for long periods as this will cause excessive ice formation and make the freezer compartment more costly to run.
- Don't:-** Put liquid-filled bottles or sealed cans containing carbonated liquids (fizzy drinks, etc) into the freezer compartment as they may burst.
- Don't:-** Try to keep frozen food which has thawed; it should be eaten within 24 hours or cooked and refrozen.
- Don't:-** Give children lollipops and water ices direct from the freezer compartment. The low temperature may cause 'freezer burns' on their lips.
- Don't:-** Leave the freezer drain plug out of the drain.
- Don't:-** Store poisonous or dangerous substances in the freezer. Your freezer has been designed for the storage of edible foodstuffs only.

Storing Food

Storing food in the fridge compartment

Your fridge compartment has been designed to store a wide variety of food items. In order to do this effectively there are different temperature zones inside your fridge compartment in order to create the ideal storage conditions. A guide to the maximum storage times are given in the table below. It is advisable to read the storage/use by instructions provided on the packaging. Select chilled foods fast when shopping, transport them home in a 'cool bag' and place in a fridge as soon as possible after arriving home. It is advisable to store food in the correct

Zone. See chart below:

Zone	Advisable position for storage
A	Dairy products – Cheese, butter, margarine, low fat spreads, cooking fats/ars.
Cool zone	Preserves – Jam, curds, marmalades, spreads, salad dressings, sauces, spreads.
B	General food storage.
Colder zone	
C	Fresh meat, fish & poultry. Pre-cooked/chilled food. (These items must be stored above any raw meat, fish or poultry.)
Colest zone	
D	Vegetables, fruit and salad items.
Salad bin	(Note: It is not possible to store bananas or onions in a fridge.)

Max. storage time	Days
Raw fresh meat	
joints, steaks, chops	1
offal (liver, kidney etc)	1
minced meat, sausages	1
Cooked meat	
cooked meat	1
made-up dishes and left-overs	1
Poultry	
fresh, whole (store giblets separately)	1
cooked	1
giblets	1
Fish	
raw	1
cooked	2
Bacon	
joints (uncooked)	2-8
rashers	2-10
ham (unsmoked)	1-3
pasteurised and homogenized	1-3
Milk	
fresh	2
Cream	
yogurt, sour cream	2-10
Butter	
	14-28
Margarine and cooking fats	
	21-28
Cheese	
hard	7-28
semi hard, blue	7-14
cream, cottage	7
Eggs	
shell	7-28
hard boiled	1-3
Vegetables	
vegetables	2-14
Salad	
vegetables prepared	2-14
prepared	1-3

All foods should be wrapped or covered to prevent drying out and flavour transference. Plastic bags, containers with lids, foil and plastic stretch wrap are ideal. Never put hot or warm food into your fridge as this reduces efficiency. Left over canned food should **not** be stored in the can; place it in a covered storage container and place in the fridge.

Storing food in the freezer compartment

Your freezer compartment carries the ******** symbol which indicates that it is suitable for the long-term storage of commercially frozen foods and also can be used to freeze and store fresh food.

The freezer compartment will store up to 20 kg (44 lb) of frozen food. This figure is based on an average density of 0.32 kg of mixed food per litre of net storage volume (20 lb per cubic foot). In the case of meat it will take appreciably more.

Generally speaking long-term storage means up to 3 months, but this will vary with the nature of the packaged food, so always follow the manufacturer's recommended storage time given on the packet. For storing home frozen fresh food refer to the pictorial guide on the door liner.

If there is a power failure do not open the freezer compartment door

Frozen food should not be affected if the failure lasts for less than 19 hours. If the failure is longer then the food should be checked and either eaten immediately or cooked and then refrozen.

Freezing fresh foods

Maximum freezing loads

You can freeze up to 4 kg (8.8 lb) of fresh or cooked food in any 24 hours.

Put the fresh food into the freezer compartment with as much food as possible in contact with the floor.

There is no need to adjust the Control Dial.

You may find water droplets forming on the outside of the cabinet whilst freezing fresh foods. Do not worry as they will disappear when freezing is over.

Do's and Don'ts

Fridge compartment

Do:- Take off any unusable leaves on vegetables and wipe off any soil.

Do:- Leave lettuce, cabbage, parsley and cauliflower on the stem.

Do:- Wrap cheese firstly in greaseproof paper and then in a polythene bag excluding as much air as possible. For best results take out of the fridge compartment an hour before eating.

Do:- Wrap raw meat and poultry loosely in polythene or aluminium foil. This prevents drying.

Do:- Wrap fish and offal in polythene bags

Do:- Wrap foods which have a strong odour or can dry out in polythene bags, aluminium foil or place in airtight containers.

Do:- Wrap bread well to keep it fresh.

Do:- Chill white wines, beer, lager and mineral water before serving.

Do:- Make sure the gutter at the back of the fridge compartment is always clear. Remove any particles of food which may collect there.

Do:- Ensure that cooked foods are allowed to cool before storing in the fridge.

Do:- Ensure that raw and cooked meat are packaged separately.

Do:- Keep food for as short a time as possible and adhere to 'sell by' dates.

Do:- Store raw meat and poultry below cooked foods and dairy products.

Do:- Clean out your salad crisper regularly.

Don't:- Store bananas in the fridge compartment.

Don't:- Store melon in the fridge compartment. It can be chilled for short periods as long as it's wrapped to avoid it flavouring other food.

Don't:- Wash eggs as this removes their natural protective film. Wipe them instead.

Don't:- Use eggs straight from the fridge compartment, especially when making cakes or mayonnaise. Allow them to reach room temperature before use.

Don't:- Leave the door open for long periods as this will make the fridge compartment more costly to run.

Don't:- Cover the shelves with any protective materials which may obstruct air circulation through them.

Don't:- Let anything touch the cooling plate at the back of the fridge compartment.

Don't:- Store poisonous or dangerous substances in the fridge. Your fridge has been designed for the storage of edible foodstuffs only.

Don't:- Consume food which has been stored for an excessive time in the fridge.

Don't:- Let defrosting food or food juices drip onto food in your fridge.