

***PROFESSIONAL***

**Model PMD351 User Guide**

---



Combination Stereo Cassette Deck/CD Player

**marantz**

CLASS 1 LASER PRODUCT  
LUOKAN 1 LASERLAITE  
KLASS 1 LASERAPPARAT

**COMPACT**  
**disc**  
**DIGITAL AUDIO**

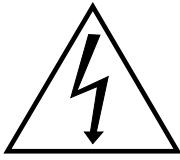
**WARNINGS  
CAUTIONS**

	<b>CAUTION</b> RISK OF ELECTRIC SHOCK DO NOT OPEN	
CAUTION: TO REDUCE THE RISK OF ELECTRIC SHOCK, DO NOT REMOVE COVER (OR BACK) NO USER-SERVICEABLE PARTS INSIDE REFER SERVICING TO QUALIFIED SERVICE PERSONNEL		

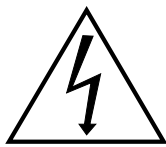

The lightning flash with arrowhead symbol within an equilateral triangle is intended to alert the user to the presence of uninsulated "dangerous voltage" within the product's enclosure that may be of sufficient magnitude to constitute a risk of electric shock to persons.



The exclamation point within an equilateral triangle is intended to alert the user to the presence of important operating and maintenance (servicing) instructions in the literature accompanying the product.

**WARNING**

**TO REDUCE THE RISK OF FIRE OR ELECTRIC SHOCK,  
DO NOT EXPOSE THIS APPLIANCE TO RAIN OR MOISTURE.**

---

**CAUTION: TO PREVENT ELECTRIC SHOCK, MATCH WIDE  
BLADE OF PLUG TO WIDE SLOT, FULLY INSERT.**

**ATTENTION: POUR ÉVITER LES CHOCS ÉLECTRIQUES,  
INTRODUIRE LA LAME LA PLUS LARGE DE LA FICHE DANS  
LA BORNE CORRESPONDANTE DE LA PRISE ET POUSSER  
JUSQU'AU FOND.**

---

**LASER SAFETY**

This unit employs a laser. Only a qualified service person should remove the cover or attempt to service this device due to possible eye injury.

**CAUTION : USE OF CONTROLS OR ADJUSTMENTS OR  
PERFORMANCE OF PROCEDURE OTHER THAN  
THOSE SPECIFIED HEREIN MAY RESULT IN  
HAZARDOUS RADIATION EXPOSURE.**

# IMPORTANT SAFETY INSTRUCTIONS

## READ BEFORE OPERATING EQUIPMENT

This product was designed and manufactured to meet strict quality and safety standards. There are, however, some installation and operation precautions which you should be particularly aware of.

1. Read Instructions – All the safety and operating instructions should be read before the product is operated.
2. Retain Instructions – The safety and operating instructions should be retained for future reference.
3. Heed Warnings – All warnings on the product and in the operating instructions should be adhered to.
4. Follow Instructions – All operating and use instructions should be followed.
5. Cleaning – Unplug this product from the wall outlet before cleaning. Do not use liquid or aerosol cleaners. Use a damp cloth for cleaning.
6. Attachments – Do not use attachments not recommended by the product manufacturer as they may cause hazards.
7. Water and Moisture – Do not use this product near water—for example, near a bath tub, wash bowl, kitchen sink, laundry tub, swimming pool, in a wet basement, and the like.
8. Accessories – Do not place this product on an unstable cart, stand, tripod, bracket, or table. The product may fall, causing serious injury to a child or adult, and serious damage to the product. Use only with a cart, stand, tripod, bracket or table recommended by the manufacturer, or sold with the product. Any mounting of the product should follow the manufacturer's instructions, and should use a mounting accessory recommended by the manufacturer.
9. A product and cart combination should be moved with care. Quick stops, excessive force, and uneven surfaces may cause the product and cart combination to overturn.
10. Ventilation – Slots and openings in the cabinet are provided for ventilation and to ensure reliable operation of the product and to protect it from overheating. These openings must not be blocked or covered. The openings should never be blocked by placing the product on a bed, sofa, rug, or other similar surface. This product should not be placed in a built-in installation such as a bookcase or rack unless proper ventilation is provided or the manufacturer's instructions have been adhered to.
11. Power Sources – This product should be operated only from the type of power source indicated on the marking label. If you are not sure of the type of power supply to your home, consult your product dealer or local power company. For products intended to operate from battery power or other sources, refer to the operating instructions.
12. Grounding or Polarization – This product may be equipped with a polarized alternating-current line plug (a plug having one blade wider than the other). This plug will fit into the power outlet only one way. This is a safety feature. If you are unable to insert the plug fully into the outlet, try reversing the plug. If the plug should still fail to fit, contact your electrician to replace your obsolete outlet. Do not defeat the safety purpose of the polarized plug.
13. Power Cord Protection – Power supply cords should be routed so that they are not likely to be walked on or pinched by items placed upon or against them, paying particular attention to cords at plugs, convenience receptacles, and the point where they exit from the product.
14. Protective Attachment Plug – The product is equipped with an attachment plug having overload protection. This is a safety feature. See Instruction Manual for replacement or resetting of

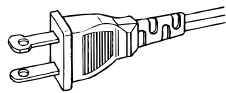

AC POLARIZED PLUG

15. Outdoor Antenna Grounding – If an outside antenna or cable system is connected to the product, be sure the antenna or cable system is grounded so as to provide some protection against voltage surges and built-up static charges. Article 810 of the National Electrical Code, ANSI/NFPA 70, provides information with regard to proper grounding of the mast and supporting structure, grounding of the lead-in wire to an antenna discharge unit, size of grounding conductors, location of antenna-discharge unit, connection to grounding electrodes, and requirements for the grounding electrode. See Figure 1.
16. Lightning – Lightning – Unplug the unit from the wall outlet and disconnect the antenna or cable system for added protection during a lightning storm or when it is left unattended and unused for long periods of time. This will prevent damage to the product due to lightning and power line surges.
17. Power Lines – An outside antenna system should not be located in the vicinity of overhead power lines or other electric light or power circuits, or where it can fall into such power lines or circuits. When installing an outside antenna system, extreme care should be taken to keep from touching such power lines or circuits as contact with them might be fatal.
18. Overloading – Do not overload wall outlets, extension cords, or integral convenience receptacles as this can result in a risk of fire or electric shock.
19. Object and Liquid Entry – Never push objects of any kind into this product through openings as they may touch dangerous voltage points or short-out parts that could result in a fire or electric shock. Never spill liquid of any kind on the product.
20. Servicing – Do not attempt to service this product yourself as opening or removing covers may expose you to dangerous voltage or other hazards. Refer all servicing to qualified service personnel.
21. Damage Requiring Service – Unplug this product from the wall outlet and refer servicing to qualified service personnel under the following conditions:
  - a. When the power supply cord or plug is damaged.
  - b. If liquid has been spilled, or objects have fallen into the product.
  - c. If the product has been exposed to rain or water.
  - d. If the product does not operate normally by following the operating instructions. Adjust only those controls that are covered by the operating instructions, as an improper adjustment of other controls may result in damage and will often require extensive work by a qualified technician to restore the product to its normal operation.
  - e. If the product has been dropped or damaged in any way, and
  - f. When the product exhibits a distinct change in performance – this indicates a need for service.
22. Replacement Parts – When replacement parts are required, be sure the service technician has used replacement parts specified by the manufacturer or have the same characteristics as the original part. Unauthorized substitutions may result in fire, electric shock, or other hazards.
23. Safety Check – Upon completion of any service or repairs to this product, ask the service technician to perform safety checks to determine that the product is in proper operating condition.
24. Wall or Ceiling Mounting – The product should be mounted to a wall or ceiling only as recommended by the manufacturer.
25. Heat – The product should be situated away from heat sources such as radiators, heat registers, stoves, or other products (including amplifiers) that produce heat.

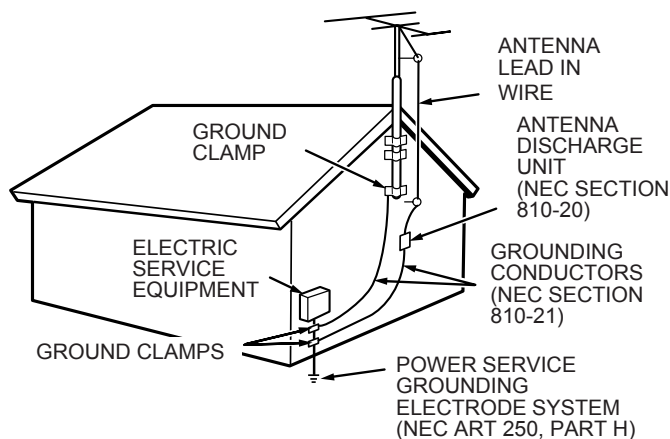

FIGURE 1  
 EXAMPLE OF ANTENNA GROUNDING AS PER  
 NATIONAL ELECTRICAL CODE, ANSI/NFPA 70  
 NEC - NATIONAL ELECTRICAL CODE

**NOTE TO CATV SYSTEM INSTALLER:**

This reminder is provided to call the CATV (Cable-TV) system installer's attention to Article 820-40 of the NEC, which provides guidelines for proper grounding and, in particular, specifies that the cable ground shall be connected to the grounding system of the building, as close to the point of cable entry as practical.

**NOTE:**

This equipment has been tested and found to comply with the limits for a Class B digital device, pursuant to Part 15 of the FCC Rules. These limits are designed to provide reasonable protection against harmful interference in a residential installation. This equipment generates, uses and can radiate radio frequency energy and, if not installed and used in accordance with the instructions, may cause harmful interference to radio communications. However, there is no guarantee that interference will not occur in a particular installation. If this equipment does cause harmful interference to radio or television reception, which can be determined by turning the equipment off and on, the user is encouraged to try to correct the interference by one or more of the following measures:

- Re-orient or relocate the receiving antenna.
- Increase the separation between the equipment and receiver.
- Connect the equipment into an outlet on a circuit different from that to which the receiver is connected.
- Consult the dealer or an experienced radio/TV technician for help.

**NOTE: Changes or modifications may cause this unit to fail to comply with Part 15 of the FCC Rules and may void the user's authority to operate the equipment.**

**WARNINGS**

- Do not expose the equipment to rain or moisture.
- Do not remove the cover from the equipment.
- Do not insert anything into the equipment through the ventilation holes.
- Do not cover the ventilation with any items such as tablecloths, newspapers, curtains, etc.
- No open flame sources, such as lighted candles, should be placed on the equipment.
- When disposing of used batteries, please comply with governmental regulations or environmental public instruction's rules that apply in your country or area.

**CE marking (only EU version)**

 This product is in conformity with the EMC directive and low-voltage directive.

**Equipment mains working system**

This product complies with household power and safety requirements in your area.

**This Class B digital apparatus complies with Canadian ICES-003.**

Cet appareil numérique de la Classe B est conforme à la norme NMB-003 du Canada.

# CONTROL AND CONNECTION DIAGRAMS

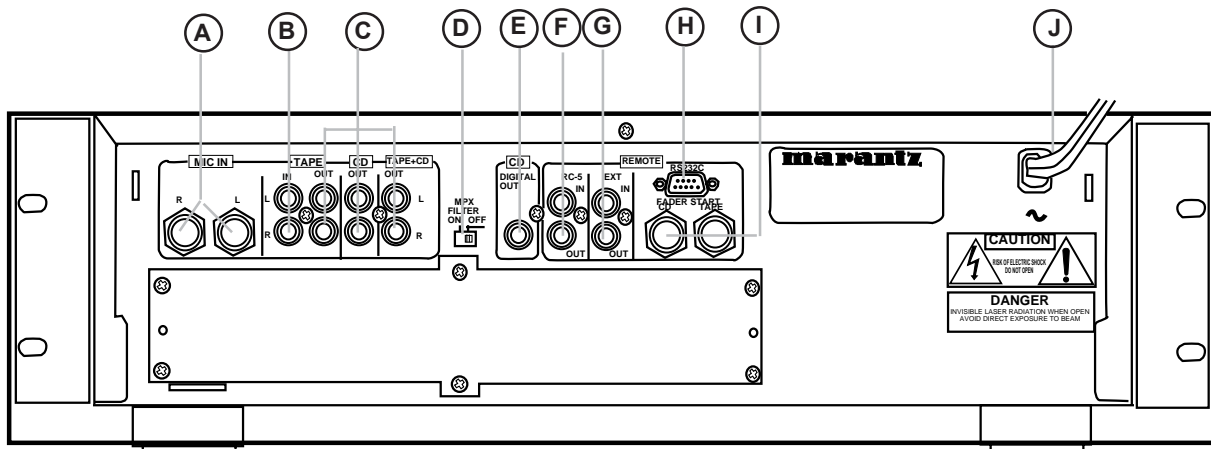
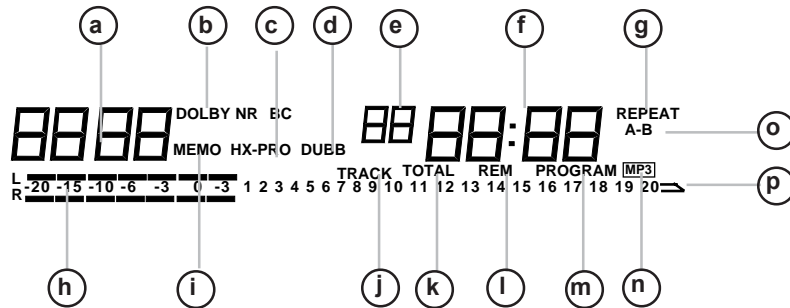
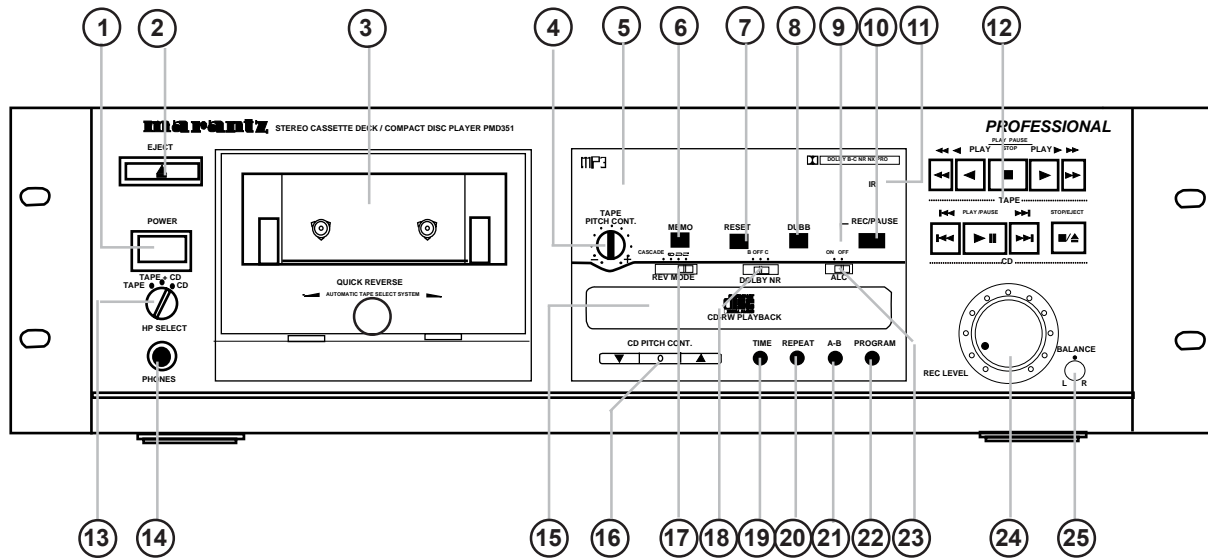

# TABLE OF CONTENTS

PRECAUTIONS	
WARNINGS CAUTIONS .....	2
IMPORTANT SAFETY INSTRUCTIONS .....	3
CONTROL AND CONNECTION DIAGRAMS .....	5
TABLE OF CONTENTS .....	6
INTRODUCTION .....	7
OPERATING PRECAUTIONS .....	7
FEATURES .....	7
QUICK OPTICAL AUTO REVERSE .....	7
TAPE AND CD PITCH CONTROL .....	7
IR RECEIVER .....	7
RC-5 REMOTE CONTROL COMPATIBILITY .....	7
ONE-TOUCH DUBBING .....	7
A-B REPEAT .....	7
LOCKABLE REM TRACK TIME MODE .....	7
ONE-TRACK PLAY .....	7
CD-R/CD-RW PLAY .....	7
MP3 .....	7
AUTO CUE CD PLAY .....	7
DOLBY NR SYSTEMS .....	7
DOLBY HX PRO HEADROOM EXTENSION .....	8
FRONT PANEL CONTROLS AND DISPLAYS .....	8
TAPE DECK CONTROL buttons .....	8
CD PLAYER CONTROL buttons .....	9
DISPLAY .....	11
REAR PANEL CONNECTIONS .....	12
OPERATIONS .....	12
CASSETTE DECK OPERATION .....	12
TAPE PLAYBACK .....	12
TAPE REWIND/FAST FORWARD .....	13
TAPE RECORD .....	13
CD PLAYER OPERATION .....	13
CD PLAYBACK .....	13
SELECTING THE TRACK .....	14
PROGRAM PLAY .....	14
MP3 PLAYBACK .....	15
CD TO TAPE DUBBING .....	16
MANUAL LEVEL TAPE DUBBING .....	16
AUTOMATIC RECORD LEVEL TAPE DUBBING .....	17
EXTENDED CASCADE OPERATION .....	17
EXTENDED CASCADE PLAYBACK .....	17
EXTENDED CASCADE RECORDING .....	17
SYNCHRONIZED RECORDING CONTROL .....	18
ERASURE OF TAPE .....	18
AUTO TAPE SELECTOR .....	18
TO PROTECT VALUABLE RECORDINGS .....	18
RS-232C CONTROL .....	19
RC-5 CODES .....	21
CARE AND MAINTENANCE .....	22
CLEANING EXTERIOR SURFACES .....	22
COMPACT DISCS .....	22
TROUBLESHOOTING .....	23
TAPE DECK .....	23
CD PLAYER .....	23
SPECIFICATIONS .....	24
CONNECTIONS .....	25
LIMITED WARRANTY .....	26

## INTRODUCTION

Thank you for selecting the Marantz Professional PMD351 combination Stereo Cassette Deck/CD Player. Please read these operating instructions carefully. We recommend that you read the entire user guide prior to connecting and operating the unit. It is also recommended that all connections be made prior to operating the unit. Please refer to this manual to identify controls and connections for operation of the unit.

## OPERATING PRECAUTIONS

When setting up the equipment ensure that:

- air is allowed to circulate freely around the equipment,
- the equipment is on a vibration free surface,
- the equipment will not be exposed to interference from an external source,
- the equipment will not be exposed to excessive heat, cold, moisture or dust,
- the equipment will not be exposed to direct sunlight, and
- heavy objects are not placed on the equipment,
- the unit is not exposed to moisture. If so, do not operate the unit until it has been thoroughly inspected by a electrically competent technician.
- Do not disconnect AC power by pulling the power cord. Remove from the outlet by pulling on the plug only.

## FEATURES

### QUICK OPTICAL AUTO REVERSE

In addition to the normal tension reversing circuitry, the PMD351 tape transport also employs optically sensed quick auto reverse circuitry. This circuitry reacts to the clear areas of the tape, usually the leader tape, and when detected, will reverse the direction of the tape transport. This process minimizes the loss of signal being recorded or played back. This reverse process applies to all tape playback and recording modes, including auto reverse and continuous mode.

### TAPE AND CD PITCH CONTROL

The PMD351 tape player and CD player both allow for adjustment of the playback pitch from -12% to +12%. The feature is particularly useful for adjusting the unit playback pitch to allow you to tune the PMD351 to accompanying instruments and choirs.

### IR RECEIVER

The PMD351 is equipped with an IR receiver for use with remote control Model RC330 (not supplied) available from Marantz Professional.

## RC-5 REMOTE CONTROL COMPATIBILITY

The PMD351 comes equipped with an RC-5 remote in and out port. Through the use of various remote control options the major functions of the unit can be operated via wired or wireless remote control.

## ONE-TOUCH DUBBING

The PMD351 allows for the dubbing of a CD to a tape with one-button start control. This feature allows you to manually or automatically select the recording level you desire.

## A-B REPEAT

The PMD351 allows you to select two points within the CD playback mode and repeat the audio playback within these points until a stop command is issued.

## LOCKABLE REM TRACK TIME MODE

The CD time display can be toggled between the various modes of display. In addition, when a display mode is set, the unit will remain in the selected mode until you change it. This is particularly useful for monitoring the audio during performances and programs.

## ONE-TRACK PLAY

The PMD351 can be set to allow for the CD player to play the selected track and return to the stop mode rather than continue on to the next track on the CD.

## CD-R/CD-RW PLAY

In addition to conventional music CDs and CD-R (recordable) discs, this player can also play CD-RW (rewritable) discs. It can also play unfinalized discs that cannot be played by regular CD players.

## MP3

This player can play discs containing MP3 files.

## AUTO QUE CD PLAY

The CD player on the PMD351 contains an Auto Que feature. This feature allows the CD player to advance to the beginning of the audio within the track rather than start from the track start flag. This feature helps to minimize the silence at the beginning of a CD track playback.

## DOLBY NR SYSTEMS

The Dolby Noise Reduction systems compress and amplify the tape during recording in order to raise the signal-to-noise ratio on the tape. During playback, these signals are expanded and attenuated by the same amount in order to regain the original dynamic range of music. An additional result of this expansion and attenuation is that the noise floor of the recording is reduced significantly. Dolby B typically reduces noise by 10dB. Dolby C typically reduces noise by 20dB.

### DOLBY HX PRO HEADROOM EXTENSION

The Dolby HX PRO system monitors the total amount of effective bias during recording and instantaneously compensates for any excess bias by reducing the deck's bias signal level accordingly. The system operates independently on each channel. HX PRO is unlike a noise reduction system because it functions only during recording and no decoding is required. Therefore a tape recorded with the HX PRO system can be played back on any other cassette deck while retaining the benefits of HX PRO.

### FRONT PANEL CONTROLS AND DISPLAYS

- ① **Power switch button**  
Push the POWER switch in to turn power to the unit on and off. When power is turned off, all past settings are removed from memory and the unit returns to its default setting upon the next power up.
- ② **EJECT button**  
Press the eject button to open the cassette tape holder. The EJECT button will not function unless the tape deck is in the stop mode. Thus, if the power is turned off without hitting the STOP button, the door may not open.
- ③ **CASSETTE TAPE HOLDER**  
This section holds the cassette tape for tape Play and Record functionality. Tapes that have the record protect knock-out removed will not enter into the record mode.
- ④ **TAPE PITCH control**  
Rotate the TAPE DECK pitch control to adjust the tape deck playback pitch from -12% to +12%. While the control is in the center detent position, the tape deck is at normal (0% pitch variance) speed. This control has no effect on the tape pitch during the record mode.
- ⑤ **DISPLAY**  
See next section for description of display elements.

#### TAPE COUNTER buttons

The MEMO button ⑥ and RESET button ⑦ control the tape counter (DISPLAY a). The tape counters are only approximate measurements of minutes and seconds and are not intended for timing-critical applications. They are most accurate with 60 minute tapes.

- ⑥ **MEMO button**  
Press the MEMO button to store a memory point into the counter memory. Once this point is set, the tape deck will rewind or fast forward until it reaches this point in the tape and will stop. To cancel the memory control, press the MEMO button again.
- ⑦ **RESET button**  
Press the RESET button to reset the current tape counter reading from its existing point to "0000"
- ⑧ **DUBB button**  
Press the DUBB button to engage the tape transport into the dubbing mode from the CD player. Once the DUBB button is pressed, the CD player will copy directly to the tape deck.
- ⑨ **REC indicator**  
Displayed when the tape deck is in the Record mode. When the REC indicator is flashing, this indicates the tape deck is in the Record Pause mode.
- ⑩ **REC/PAUSE button**  
Press the REC/PAUSE button to engage the tape transport into the record pause mode. In this mode, the tape deck is armed to begin recording. The tape record mode can be engaged by pressing the forward play or reverse play buttons.
- ⑪ **IR sensor**  
Sensor for receiving infrared remote control signals. Model RC330 IR control emitter is available from Marantz Professional.
- ⑫ **TAPE DECK AND CD PLAYER CONTROLS**

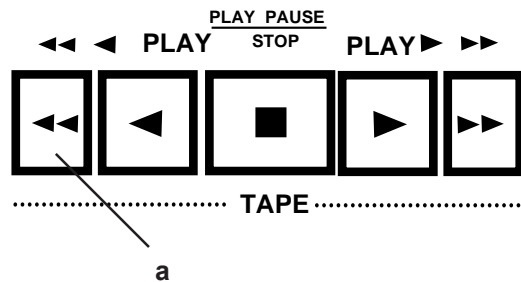

#### TAPE DECK CONTROL buttons

- a **REWIND button** ◀◀  
Press the REWIND button ◀◀ to engage the tape transport into fast rewind mode from the right (take-up) to the left (supply) reels.



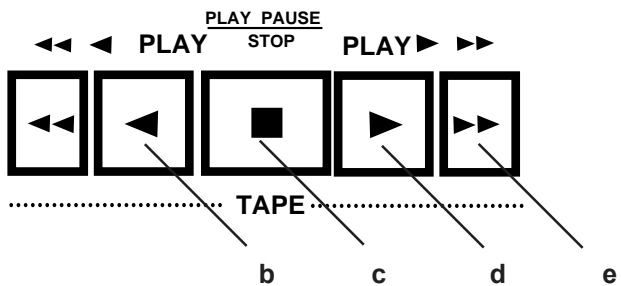

- b REVERSE PLAY button ◀**  
Press the REVERSE PLAY button ◀ to engage the tape deck into the reverse play function.
- c STOP button ■**  
Press the STOP button ■ to cancel all current operations of the tape deck.
- d FORWARD PLAY button ▶**  
Press the FORWARD PLAY button ▶ to engage the tape deck into the forward play function. Indicator light in the button is lit during forward play, flashing during stop or pause.
- e FAST FORWARD button ▶▶**  
Press the FAST FORWARD button ▶▶ to engage the tape transport into the fast forward wind mode from the left (supply) to the right (take-up) reels.

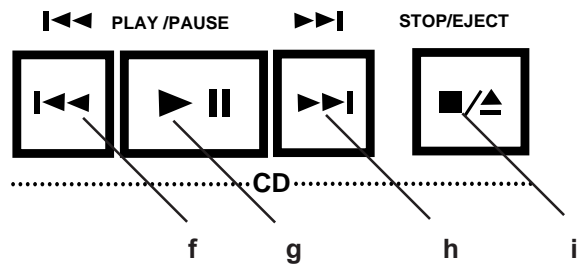

**CD PLAYER CONTROL buttons**

- f PREVIOUS/SEARCH REVERSE button ◀◀**  
When the CD player is in the play or pause mode, press and release the PREVIOUS/SEARCH REVERSE button ◀◀ to skip back to the beginning of the current track and then skip one track for every time the control button is pressed and released. Keeping this control pressed for more than 1/2 a second causes the unit to retreat (backward scan) within the track. The track time display will show your current location within the song. During the program

mode, this function is used along with the NEXT/SEARCH FAST FORWARD button ▶▶ to select the desired tracks to be played.

**Note:**  
Automatic search operations cannot operate on the Tape and CD at the same time.

- g PLAY/PAUSE button ▶||**  
Press the PLAY/PAUSE button ▶|| to change the CD player mode from CD play to CD pause or from CD pause to CD play.
- h NEXT/SEARCH FAST FORWARD button ▶▶**  
When the CD player is in the play or pause mode, pressing the NEXT/SEARCH FAST FORWARD button ▶▶ will skip forward one track for every time the control button is pushed. Keeping this control depressed causes the unit to advance (scan) into the track. The track time display will show your current location within the song. During the program mode, this function is used along with the PREVIOUS/SEARCH REVERSE button ◀◀ to select the desired tracks to be played.
- i STOP/EJECT button ■/▲**  
Press the STOP/EJECT button ■/▲ to stop the CD Player while in the play mode. Press the STOP/EJECT button ■/▲ while in the Stop mode to open the door and eject the disk. During the program mode, the STOP/EJECT button ■/▲ will cancel the current program as long as the CD player is in the Stop mode.

**13 HP SELECT switch**  
The HP SELECT switch (Headphone selector switch) is used to switch the headphone output.

**14 HEADPHONES jack**  
The HEADPHONES jack is used to allow monitoring of the Tape, CD or Tape/CD Mix through headphones. This jack requires that a 1/4" headphone jack connection be made and the desired source can be selected by the HP SELECT switch located directly above the headphone input jack.

**15 COMPACT DISC tray**  
The COMPACT DISC tray is used to hold the desired CD for playback.

- 16 CD PITCH CONTROL buttons**  
By pressing the CD player PITCH CONTROL buttons, you can adjust the CD player playback pitch from -12% to +12% in 0.1% increments. You can return the CD player to the normal speed position by pressing the center "0" control. Pressing the center "0" control again returns it to the previous settings.

**CAUTION** - When the CD pitch control is used, digital lock may not occur with some D/A converters connected via the CD DIGITAL OUT jack (E).

- 17 REVERSE MODE switch**  
The REVERSE MODE switch allows you to set the automatic tape direction operation of the tape transport during playback, normal recording or dubbing. The four positions of this switch are as follows;

 **One-way mode.**  
In this position, the tape will play or record one side of the tape and stop.

 **Two-way mode.**  
In this position, the tape will play or record both sides of the tape and stop.

 **Continuous mode.**  
In this position, the tape will play in a continuous loop until the stop command is given. In the record mode, the tape will record both sides of the tape and stop.

**Notes:**

Quick reverse operation will only occur after the transport has been moving for 15 seconds. Before that time, it takes approximately four seconds to reverse. One second of audio is lost during quick reverse.

**CASCADE**

**CASCADE mode:**

In this position, multiple Marantz Professional tape decks that are equipped with the "EXT" cascade connector can be looped together to allow for extended cascade playback or recording. In this mode, the tape will play or record both sides of the tape; and, at the end of the tape on the first deck, a command will be issued causing the next deck in line to begin cascade play or record. This will continue until the end of the last tape on the last deck of the loop is reached.

- 18 DOLBY NR switch**  
The DOLBY NR switch allows for the encoding or decoding of Dolby B or C Noise Reduction. When recording with Dolby Noise Reduction on, select the type (B or C) of noise reduction desired and place the switch in the appropriate position. When playing a tape with Dolby Noise Reduction encoded onto it, place this switch in the same position (B or C) in which it was recorded.

- 19 TIME button**  
By pressing the TIME button, you can adjust the CD player time displayed from the following formats.

**NORMAL** - Displays the time elapsed within the current track being played. No special indicator.

**REM** - Displays the remaining time left of the current track being played. REM indicator (item ① in the display) is lit.

**TOTAL REM** - Displays the total time remaining on the current disk being played. TOTAL and REM indicators (items (k) and ① in the display) are both lit.

The TIME button can be toggled between the various displays by pressing the TIME button multiple times.

- 20 REPEAT button**  
By pressing the REPEAT button, you can program the CD player to repeat all tracks of the current disk. When there is a CD play program that is currently active, this function will repeat the current program selections. To clear this function, press the repeat control button again.

- 21 A-B button**  
The A-B button allows you to repeat a specific section in the current CD track that is being played. When this control is pressed the first time, the A-B indicator flashes and this position on the track is noted as the start or A point. When this control is pressed again, the A-B indicator is lit and this position on the track is noted as the end or B point. After setting the end point, the CD player returns to the start point (A) and plays until it reaches the end point (B). The CD player will repeat this function until the stop or REPEAT button is pressed again.

- 22 PROGRAM button**  
The PROGRAM button will place the CD player into the program entry mode or the single track play mode. When the PROGRAM button is pressed once, the CD player enters the program entry mode and the program indicator will begin

to flash. Pressing the PROGRAM button again will place the CD player in the single track play mode, and the track indicator will begin to flash. Pressing the PROGRAM button again will return the CD player to the normal play mode.

- (23) ALC switch (AUTOMATIC LEVEL CONTROL)**  
The ALC switch allows for automatic control of the source level during recording. When this switch is set to the **OFF** position, the level of recording is controlled by the manual record level adjustment. When this control is set to the **ON** position, the record level is set automatically. In this position, the manual record level adjustment has no effect on the recording.
- (24) MANUAL RECORD LEVEL control**  
The MANUAL RECORD LEVEL control allows you to adjust the record level up or down during recording.
- (25) RECORD BALANCE control**  
The RECORD BALANCE control allows for the adjustment of the record level between the left and right channels. By using a Phillips-type screwdriver, you can adjust this balance control between Left (Counterclockwise) and Right (Clockwise).

## DISPLAY

- (a) Tape counter** display indicates the amount of tape that has been transported across the head in digits.
- (b) Dolby NR B C** indicators display the type of Dolby noise reduction that has been selected. **Level indicators** display the record or playback signal levels of the tape deck.
- (c) HX PRO indicator** is displayed showing HX PRO is activated.
- (d) DUBB indicator** is displayed when dubbing from the CD player to the tape deck.
- (e) TRACK number indicator** displays the track number that the CD has identified in play or pause mode. In the stop mode, the number of tracks on the entire CD or the numbers of the tracks programmed to play are displayed. When the TRACK number indicator is flashing, it indicates that the CD player is in the single-track play mode. When in this mode, the CD player will play the selected track and go to the stop mode.
- (f) TRACK time indicator** displays the playing time of the CD in four digits, representing minutes and seconds. This display typically represents elapsed time of the track being played. When the **REM indicator** is displayed, the time shown represents the remaining time of the track being played. When the **TOTAL REM** indicator is displayed, this represents the total remaining time of the CD or of the program currently being played. In the stop mode, the total playing time of the CD is displayed. The flashing colon, “:” indicates that the CD pitch control is in use.
- (g) REPEAT indicator** is displayed when the CD player is in the repeat mode.
- (h) Level indicators** display the record or playback signal levels of the tape deck.
- (i) MEMO indicator** is displayed when the tape deck memory function is turned on.
- (j) TRACK indicator**  
Lit as title for several CD track functions.
- (k) TOTAL indicator**  
When the TOTAL indicator and the REM indicator are both displayed, the track time indicator **(f)** represents the total remaining time of the CD.
- (l) REM indicator**  
When the REM indicator is displayed and the TOTAL indicator is not displayed, the track time indicator **(f)** represents the total remaining time of the track being played.
- (m) PROGRAM indicator** is displayed to indicate that the CD player is in the program mode. The indicator flashes during the program play entry mode. This indicator can be turned on and off by pressing the program button.
- (n) MP3 indicator** is displayed when an MP3 file is recognized.
- (o) A-B indicator** is displayed when the tape deck is in the A-B repeat mode. When the A-B indicator is flashing, this indicates standby for the setting of point B.
- (p) TRACK number indicator** (1 through 20), displays the track numbers on the CD. When in the program mode, the tracks programmed are displayed. Upon completion of playing a track, the number will disappear. When playing a CD with more than 20 tracks on it, the “=>” indicator is displayed.

## REAR PANEL CONNECTIONS

- (A) MIC (MICROPHONE) INPUT jack**  
For use with microphones as the input source into the tape deck. When microphones are installed into these jacks, the line inputs are automatically switched off and only the microphone signal is input into the unit. For mono recording, insert the microphone into the L (Left) jack.
- (B) TAPE IN jacks**  
These RCA jacks should be connected to the LINE OUTPUT of your source.
- (C) LINE OUT (TAPE, CD, TAPE+CD)**  
These RCA jacks should be connected to the appropriate INPUT of your PA or monitoring system.
- (D) MPX FILTER switch**  
When recording FM broadcast with Dolby NR, set this switch to the ON position.
- (E) DIGITAL OUTPUT jacks (SPDIF)**  
This RCA jack outputs the digital signal of the CD Player. Connect this jack to other SPDIF digital inputs such as a D/A converter or digital sound processor or amplifier with SPDIF digital inputs such as the Marantz Professional CD Recorder. Digital signals are not output while MP3 files are playing.
- (F) RC-5 REMOTE CONTROL jacks**  
These RCA jacks are used with Marantz Professional infrared or wired remote accessories to provide remote control operation of the PMD351. These jacks can be serially linked to provide serial remote control operation of multiple RC-5 equipped products as well.
- (G) REMOTE EXT (extension) jacks**  
Connection with other Marantz Professional components equipped with REMOTE EXT. jacks will allow for extended cascade operation of several units.
- (H) RS-232C connector**  
Using serial communication, a host device can control this unit.
- The RS-232C host can control all functions of the PMD351 externally
  - The PMD351 automatically transmits status data when status is changed.
  - The PMD351 will respond to a status request by transmitting the associated status data

- (I) FADER START jacks**  
Upon receiving a dry switch contact closure on the jack connections, the CD Player can be switched in and out of play and play/pause mode. The Tape deck can be switched in and out of play and stop or the record and stop mode.
- (J) POWER CORD**  
120VAC input power connector.

## Operations

The following operating procedures are based on the assumption that the power switch is set to the ON position and that all input and output connections have already been made. For examples of input and output connections, please refer to the section in this manual marked "Connections".

## CASSETTE DECK OPERATION

### TAPE PLAYBACK

1. Open the cassette holder by pressing the eject button. Load a cassette tape into the cassette holder and close. The ► indicator on the play control button will begin to flash.
2. Set the Dolby Noise Reduction control switch to the same position as the tape was originally recorded in (i.e. tapes recorded with Dolby B noise reduction need to have this switch in the Dolby B position, tapes recorded with Dolby C noise reduction need to have this switch in the Dolby C position, and tapes recorded without Dolby Noise Reduction need to have this control set to the Off position).
3. Set the reverse mode control switch to the desired position.
4. Press the ► play control button to begin playback in the forward direction. Press the ◀ play control button to begin playback in the reverse play direction. When the tape enters into the playback mode, the indicator on the play control button will change from the flashing mode to a constant on mode to indicate playback is operating.
5. Pressing the stop control button will stop the tape transport during playback.

## TAPE REWIND/FAST FORWARD

Regardless of the direction that the tape transport is currently in, pressing the ►► (Fast Forward) control button will place the tape transport in the high speed fast forward mode and the tape will advance quickly from left to right. Pressing the ◀◀ (Rewind) control button will place the tape transport in the high speed rewind mode and the tape will retract quickly from right to left. In either the fast forward or the rewind mode, the tape transport will continue to fast forward or rewind until the stop control button is pressed or the end of the tape is reached.

### Note:

Automatic search operations cannot operate on the Tape and CD at the same time.

## TAPE RECORD

1. Open the cassette holder by pressing the EJECT button. Load a recordable cassette tape into the cassette holder and close. The ► indicator on the ► play control button will begin to flash. (If you wish to change the tape direction, press the ◀ play control button and then press the ■ stop control button).
2. Set the DOLBY NR switch to the position that you want to record the tapes' noise reduction in (i.e. tapes to be recorded with Dolby B noise reduction need to have this switch in the Dolby B position, tapes to be recorded with Dolby C noise reduction need to have this switch in the Dolby C position, and tapes to be recorded without Dolby Noise Reduction need to have this control set to the Off position). When recording FM broadcast with Dolby Noise reduction on, set the MPX FILTER switch (on the back of the unit) to the On position.
3. Set the REVERSE MODE switch to the desired position.
4. Set the ALC control to the desired position, on or off.
5. Press the REC/PAUSE button. The REC indicator will begin to flash indicating the tape transport is in the record pause mode.
6. If the ALC control is in the Off position, use the MANUAL RECORD LEVEL control to adjust the input signal to the desired recording level.
7. Press the FORWARD PLAY button ► to begin recording in the forward direction. Press the

REVERSE PLAY button ◀ to begin recording in the reverse direction. When the tape enters into the playback mode the REC indicator and the play control button indicator will change from the flashing mode to the constant on mode. This indicates the tape transport is in the record mode.

8. To pause the tape transport during recording, press the REC/PAUSE button. Press the play control button (► or ◀) to resume recording.
9. Pressing the STOP button ■ will stop the tape transport during recording. Pressing the ◀◀ rewind button in the ► play/record direction or the ►► fast forward button in the ◀ play/record direction will cause the unit to return to the position at which recording began.

## CD PLAYER OPERATION

### CD PLAYBACK

1. Open the compact disc tray by pressing the STOP/EJECT button ■/▲. Load a compact disc onto the compact disc tray and close the tray by gently pushing the front of the compact disc tray or by pressing the STOP/EJECT button ■/▲. The CD player display will show the general data of the current CD.
2. To begin playback of the compact disc, press the PLAY/PAUSE button ►||. The ► indicator in the PLAY/PAUSE button will illuminate. The display will show the data for the first track and the track will begin to play.
3. To pause the CD during playback, press the PLAY/PAUSE button ►||. The display will remain in the current position and the ► indicator in the PLAY/PAUSE button will begin to flash. Pressing the PLAY/PAUSE button ►|| will resume normal playback from the point that the CD player was paused.
4. Upon completion of playback of the last track in the disc, the CD Player will return to the stop mode. You can also stop the CD playback by pressing the STOP/EJECT button ■/▲ once. Pressing the STOP/EJECT button ■/▲ again will cause the CD tray to open.

## SELECTING THE TRACK

1. By pressing the ►► CD-NEXT or the ◄◄ CD-PREVIOUS buttons, you can select the track to be played. Each press of the ►► CD button will advance the CD player to the beginning of the next track and enter into the play/pause mode. Each press of the ◄◄ CD button will cause the CD player to skip to the beginning of the previous track and enter into the play/pause mode. Pressing the CD PLAY/PAUSE button will resume playback at the beginning of the selected track.

## PROGRAM PLAY

This procedure allows you to program selected tracks for playback in the order you desire.

1. By pressing the PROGRAM button once, you will place the CD player into the programming mode for playback. Once the PROGRAM button is pressed, the PROGRAM indicator in the CD display will begin to flash. This indicates the CD player is in the program entry mode.
2. By pressing the ►► CD NEXT or the ◄◄ CD PREVIOUS buttons, you can select the track to be programmed. Each press of the ►► CD button will advance the CD player to the beginning of the next track. Each press of the ◄◄ CD button will cause the CD player to skip to the beginning of the previous track. When the desired track number has been selected, leave the CD player untouched for approximately 1.5 seconds and the selected track will be stored in the playback program. Continue this procedure until all desired tracks (20 tracks maximum) have been programmed.
3. By pressing the PLAY/PAUSE button ►||, the CD player will exit the program entry mode and enter the program play mode. The PROGRAM indicator in the CD display will be lit and steady and the CD player will begin to play in the order selected during the programming.
4. By pressing the STOP/EJECT button ■/▲, the CD player will stop playing but will remain in the program/play mode. The program will remain in memory.
5. When the STOP/EJECT button ■/▲ is pressed while the CD player is in the stop mode and while the program is still engaged, the memorized program will be cleared.

## CD-R/CD-RW disc play

In addition to conventional music CDs and CD-R (recordable) discs, this player can also play CD-RW (rewritable) discs. It also supports the unfinalized discs that cannot be played by regular CD players.

### Playing unfinalized CD-R/CD-RW discs

CD players normally play only those discs on which the TOC information\* has been recorded. This means that in order for a CD player to play a CD-R/CD-RW disc with music recordings, the disc has to be "finalized" by writing the TOC information onto it.

Discs for which this finalizing job has not been done are called unfinalized discs. This player is designed to play these unfinalized discs as well.

\*"TOC" stands for the table of contents which contains the total number of tracks, the total play time and other such information on the disc. This information is recorded on the inner circumference area of the disc.

### Precautions for unfinalized CD-R/CD-RW discs

Take care not to scratch or dirty the area near the innermost circumference of unfinalized CD-R/CD-RW discs. Scratches, dirt or other abnormalities in this area may make it impossible for the disc to be read.

On unfinalized CD-R/CD-RW discs recorded using a CD recorder for audio applications, provisional TOC information is recorded in the PMA area\* which is further inside from the TOC information area. This player supports unfinalized discs by reading the information in the PMA area, but because this area is extremely narrow, any scratches, dirt or other abnormalities here make it impossible for discs to be read.

On some discs, this area may be very difficult to read. In cases like this, use the disc after using a CD recorder to do the finalizing. It is recommended that the finalizing be done before scratches or dirt makes it hard for the discs to be read.

\*"PMA" stands for program memory area and it refers to the area where the provisional contents information, such as the number of tracks and play times recorded on the CD-R/CD-RW discs, is recorded. Discs cannot be played by this player unless the PMA has been recorded properly.

#### Notes:

This player supports the discs which have been

recorded by any recorder that complies with the "Orange book" of CD-R/CD-RW standards.

The player can play only those discs recorded in the music format (CD-DA) or using MP3 files.

If there is not much recording time, it may be difficult for the data to be read, and it may cause an error.

When the player is to play a CD-RW disc or unfinalized CD-R/CD-RW disc, it automatically recognizes the type of disc and changes some of its internal settings to suit the disc concerned. For this reason, the disc reading process will take a little longer compared to regular music CDs or CD-R discs.

## MP3 PLAYBACK

This player can play CD-R/CD-RW discs as well as discs including MP3\* files.

\*"MP3" refers to music data which has been compressed by a file format known as "MPEG-1 Audio Layer 3." Files with the ".mp3" or ".MP3" extension are called MP3 files.

### MP3 FILE PLAYBACK

#### PLAYING ALBUMS IN SEQUENCE

1. As with a music CD, place the disc recorded using the MP3 files on the disc tray and retract the disc tray.
2. Press the ►|| button.  
Play now starts in sequence from the first album on a folder-by-folder basis\* (see Example play sequence next column).
  - \* With a disc recorded with MP3 files, it takes about 40 seconds after the player's power has been turned on for the player's system to be switched before initial play.

#### Selecting and playing albums (folders)

Select the desired album (on a folder-by-folder basis\*) using the ◀◀ or ▶▶ button. Play now starts in sequence from the selected album. The album number appears on the display. (AL xxx is displayed at (f) and the track at (e).)

\*Those items among the display information which were not recorded are skipped. Only the recorded items are displayed.

Example play sequence as displayed in Windows Explorer:

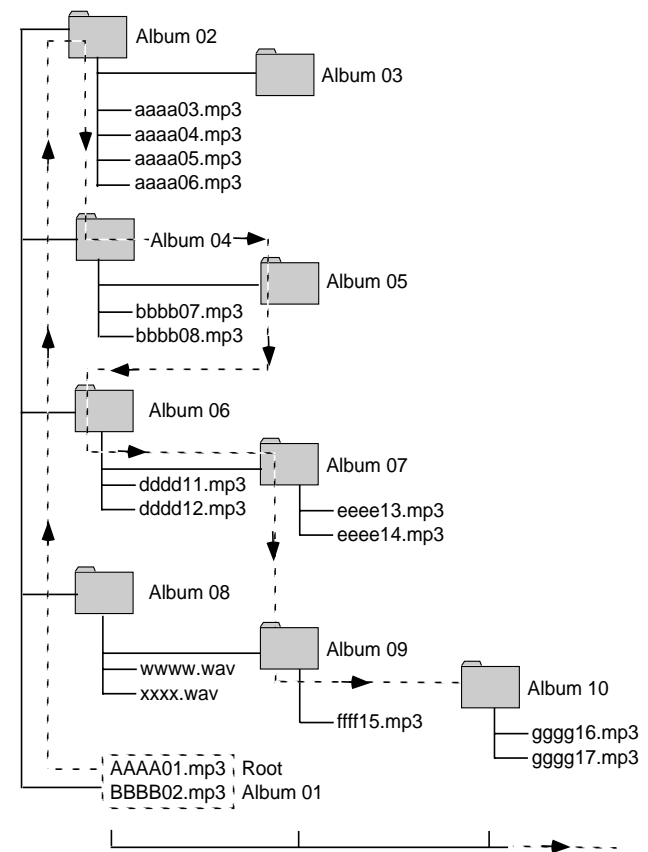

Play up to 8 hierarchical levels possible.

- The dotted line with an arrow ( .-.-> ) indicates the sequence in which the MP3 albums and tracks are played.
- Album 01 to album 10  
In the example shown, this CD-ROM has 10 albums (folders) but albums 03 and 08 are not MP3 files and so cannot be played.
- AAAA01.mp3 to gggg17.mp3  
In the example shown, this CD-ROM has 17 tracks starting with track "01" and ending with track "17."
- Only those files with the ".mp3" extension are played; all other files with the .wav, .jpg, .doc and other extensions are skipped.
- Album 01 is allocated even when there are no files in the root.
- The sequence may differ from the one that appears on the personal computer. It may also differ depending on the writing software program.

## Precautions for discs recorded using MP3 files

- The format of the files played have the “.mp3” or “.MP3” extension. Files with any other extension cannot be played.
- The Joliet file system, an extension to the ISO9660 file format, is supported as the write format. Both mode 1 (CD-ROM) and mode 2 (CD-ROM XA) are supported. MP3 file discs recorded using packet writing cannot be played.
- The recommended MP3 file sampling frequency is 44.1 kHz and the bit rate is 128 kbps. The sound may be interrupted when playing files with any other sampling frequency and bit rate.
- The maximum number of characters in the ID3 tag information that can be displayed by this player is 32. Characters other than alpha- numerics will not be displayed properly.
- Digital signals are not output from the player while playing discs recorded using MP3 files.
- It may not be possible for CD-R/CD-RW discs on which MP3 files were recorded to be played properly depending on the environment of the personal computer used to record the files, the writing software program, and the CD-R/CD-RW discs concerned. Check the external components used.
- MP3 files on mixed CDs or enhanced CDs containing a mixture of the CD-DA format for music purposes and MP3 files cannot be played. Only the CD-DA format for music purposes will be played.
- This player also supports discs created by multisessions.
- It is recommended that the maximum number of sessions on a CD-R or CD-RW disc be 10; the maximum number of albums for all sessions be 20; and the maximum number of files be 200.

## Functions not supported by MP3 play

The following functions are not supported when the player is to play discs recorded with MP3 files.

- A-B repeat
- Program play
- Delete program play
- Index skip
- End monitor
- Manual cue
- Auto cue
- Time mode changes
- End warning

## Concerning random play

Random play proceeds on an album by album (folder by folder) basis. When all the tracks of the album currently playing have been played, play moves on to the next album in the sequence. During random play, the 1-track repeat and A-B repeat functions cannot be used.

## CD TO TAPE DUBBING

The CD source can be dubbed directly onto the tape deck by two means: manual recording or automatic level control (ALC On). During manual record dubbing, the level desired is adjusted by manually adjusting the record level control. After the desired level is adjusted, you then release the tape deck to record. During ALC dubbing, the record level is adjusted automatically based on the peak levels of the source and the tape deck enters the dubbing mode automatically.

## MANUAL LEVEL TAPE DUBBING

1. By pressing the CD STOP/EJECT button and the tape eject button you can load the CD to be dubbed onto the CD tray and a recordable tape into the tape transport. Gently press the front of each mechanism to close them. The CD display will register the general CD data and the tape play indicator located inside of the tape PLAY button will begin to flash.
2. Prepare the tape for dubbing by rewinding it to the beginning of the first side onto which the tape is to be recorded.
3. Set the ALC switch to the OFF position.
4. Press the DUBB button once. The REC indicator will begin to flash; the DUBB indicator will light; and the CD player will enter play mode. At this point, you can adjust the record level control to achieve the desired record level.
5. After adjusting the record level, press the DUBB button again. The CD player will return to the stop mode and the tape transport will enter into the record mode. After approximately five seconds the CD player will enter the playback mode and begin to play the first track, dubbing it onto the tape.
6. When either the CD transport or the tape transport have reached the end and stopped, the other transport will also stop.
7. To end the dubbing during a session, press the STOP on the tape transport or the STOP/EJECT button on the CD player.



## AUTOMATIC RECORD LEVEL TAPE DUBBING

1. By pressing the CD STOP/EJECT button and the tape eject button, you can load the CD to be dubbed onto the CD tray and a recordable tape into the tape transport. Gently press the front of each mechanism to close them. The CD display will register the general CD data and the tape play indicator located inside of the Tape PLAY button will begin to flash.
2. Prepare the tape for dubbing by rewinding it to the beginning of the first side onto which the tape is to be recorded.
3. Set the ALC switch to the ON position.
4. Press the DUBB button once. The REC indicator will begin to flash; the DUBB indicator will light; and the CD player will enter play mode. The CD will automatically begin to search the source for the peak level. This procedure could take as long as five minutes to complete. Once the peak level has been determined, the record level for dubbing will be set automatically.
5. After the record level has been set, the tape transport will enter into the record mode. After approximately five seconds, the CD player will enter the playback mode and begin to play the first track, dubbing it onto the tape.
6. When either the CD transport or the tape transport have reached the end and stopped, the other transport will also stop.
7. To end the dubbing during a session, press the STOP on the tape transport or the STOP/EJECT button on the CD player.

### Notes:

When dubbing is started with a program of CD tracks, the tracks are dubbed in the order of which the original playback was programmed. For assistance in programming playback, see PROGRAM PLAY.

The CD peak level that is detected during ALC level dubbing may vary from one recording to another; however, the effect will be minimal. When recording with the reverse mode control set to the two-way or the continuous mode, there may be an interruption in recording of approximately one second during the optical reversing of the tape transport.

## EXTENDED CASCADE OPERATION

By using the cascade feature on the PMD351 with another PMD351 or other Marantz Professional products offering the cascade feature, several units can be connected to supply long playback or recording functionality.

## EXTENDED CASCADE PLAYBACK

1. Refer to the user guide of the other components to assure that all connections and switch settings are set correctly.
2. Assure that the "EXT" jack on the rear of all units are connected. Starting with the first unit to operate, connect the "EXT" out jack to the "EXT" input on the second unit to operate. Continue this set-up procedure until all units that are to operate in the cascade mode have the "EXT" control jacks serially linked together.
3. Set the PMD351 reverse mode control switch to the CASCADE position.
4. Begin the playback of the first source by pressing the play control button. The unit will enter playback mode. After the first source has completed playback, the next component in the cascade will begin playback. This will continue until the last unit linked in the cascade chain has completed playback and entered the stop mode.
5. To exit the cascade playback mode, press the stop control button of the source machine currently in playback mode.

## EXTENDED CASCADE RECORDING

1. Refer to the user guide of the other components to assure that all connections and switch settings are set correctly.
2. Assure that the "EXT" jack on the rear of all units are connected. Starting with the first unit to operate, connect the "EXT" out jack to the "EXT" input on the second unit to operate. Continue this set-up procedure until all units that are to operate in the cascade mode have the "EXT" control jacks serially linked together.
3. Set the PMD351 reverse mode control switch to the CASCADE position.
4. Place all components that are linked together in the cascade mode into the record pause mode.

- Begin the recording of the first source by pressing the play control button. The unit will enter record mode. After the first source has completed recording, the next component in the cascade will begin recording. This will continue until the last unit linked in the cascade chain has completed recording and entered the Stop mode.
- To exit the cascade record mode, press the stop control button of the source machine currently in record mode.

**Notes:**

If all components have not been set up correctly (tape or CD loaded, record pause armed, etc.) the cascade function will stop upon reaching this source machine.

If the cascade function is started with the tape first, the PMD351 will go to CD playback next and then to the next component. If the playback is started with the CD first, the PMD351 will play the CD then go to the next component.

Before beginning the cascade record function, hand wind the tape leaders so that no leader is showing. This will minimize interruptions in your recordings.

**SYNCHRONIZED RECORDING CONTROL**

The PMD351 is capable of connecting with other Marantz RC-5 based products to allow for synchronized start of the product recording through the starting of the play function of the CD player or the tape transport of the PMD351. By connecting the RC-5 output jack to the RC-5 input jack of another Marantz recorder, the PMD351 will issue a command for the recording to start as soon as the play control button is pressed on the PMD351. Pressing the stop or the stop/eject control button on the PMD-source deck will place the attached component into the record/pause mode.

During the cascade recording mode, the PMD351 can be attached to other Marantz RC-5-based decks for the purpose of small scale duplication of the dubbing source. This is accomplished by linking the RC-5 output connector to the RC-5 input of the recording deck and placing the PMD351 reverse mode control switch into the cascade position.

**Notes:**

**CAUTION**

If you must stop playback or recording in the middle of a tape, be sure to press the STOP  $\blacksquare/\blacktriangle$  button first, then turn the power off. If the power is turned off in the

middle of an operation, the cassette tape remains loaded and it may be impossible to eject. In such a case, turn the power on; enter PLAY mode; press STOP; and then eject the tape. The same caution as above applies in case of power failure. To prevent damage, never attempt to force the removal of a cassette while the power is off.

**ERASURE OF TAPE**

When a program source is recorded onto a tape, the previously recorded sound is erased automatically and replaced with the new recording. If you wish to erase a tape without recording, set the REC LEVEL control to the minimum (counterclockwise) position and let the tape travel in the Record mode.

**AUTO TAPE SELECTOR**

This unit is equipped with an auto tape selector which automatically sets the bias and equalizer level using the detection holes provided in the cassette shell. The bias and equalizer level are automatically set according to the type of cassette as follows.

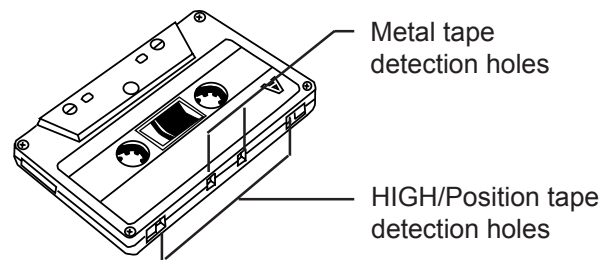

- Normal tapes                      EQ; 12 $\mu$ S,      Bias; Low
- HIGH/Position tapes            EQ; 70 $\mu$ S,      Bias; High
- Metal tapes                        EQ; 70 $\mu$ S,      Bias; Metal

**TO PROTECT VALUABLE RECORDINGS**

In the record mode, information previously recorded on the tape will automatically be erased. To prevent this from happening, use a small screwdriver to break out one or both safety tabs.

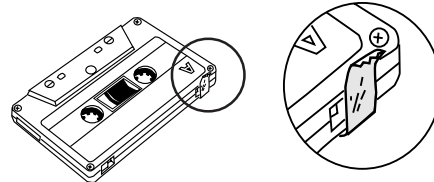
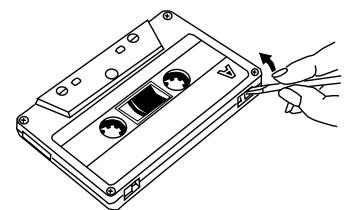

It is possible to restore the recording capability of either side of the cassette by covering the opening with clear adhesive tape.

### RS-232C control

Connect a male (D-Sub 9 Pin) to female (D-Sub 9 Pin) straight cable for RS-232C external control by host equipment.

- The RS-232C host can control all functions of the PMD351 externally
- The PMD351 automatically transmits status data when status is changed.
- The PMD351 will respond to status requests by transmitting the associated status data.

Control commands:

Request Command	CD command	TAPECommand
0	"@12000"+CR	"@11800"+CR
1	"@12001"+CR	"@11801"+CR
2	"@1202"+CR	"@11802"+CR
3	"@12003"+CR	"@11803"+CR
4	"@12004"+CR	"@11804"+CR
5	"@12005"+CR	"@11805"+CR
6	"@12006"+CR	"@11806"+CR
7	"@12007"+CR	"@11807"+CR
8	"@12008"+CR	"@11808"+CR
9	"@12009"+CR	"@11809"+CR
Time	"@120011"+CR	
Recall	"@120015"+CR	
Repeat	"@120029"+CR	
Next	"@120032"+CR	"@11832"+CR
Previous	"@120033"+CR	"@11833"+CR
Pitch Reset	"@120037"+CR	
Pitch Up Start	"@120038"+CR	
Pitch Up Stop	"@12003801"+CR	
Pitch Down Start	"@120039"+CR	
Pitch Down Stop	"@12003901"+CR	
Program/Memo	"@120041"+CR	"@11841"+CR
AMS	"@120043"+CR	"@11843"+CR
Open/Close	"@120045"+CR	
Pause	"@120048"+CR	"@11848"+CR
Clear	"@120049"+CR	
Fast Backward Start	"@120050"+CR	"@11850"+CR
Fast Backward Stop	"@12005001"+CR	
Fast Forward Start	"@120052"+CR	"@11852"+CR
Fast Forward Stop	"@12005201"+CR	
Play	"@120053"+CR	"@11853"+CR
Stop	"@120054"+CR	"@11854"+CR
A-B	"@120059"+CR	
Direction		"@11847"+CR
REC Mute		"@11842"+CR
REC		"@11855"+CR

Hand shake flow charts for control commands:

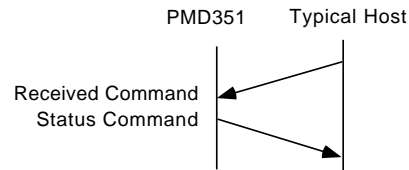

Host sends a command that causes a change in PMD351 status.

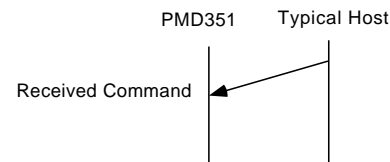

Host sends a command that causes no change in PMD351 status. For example, Host requests Play during Playback.

### Commands Requesting Status

The following Request Commands from the host are received by the PMD351, then the status code is transmitted to the host.

Request Command for CD		Response from CD	
Power	"@1?20POWE"+CR	Standby	"@120POFF"+CR
		Power On	"@120PRON"+CR
Tray Mode	"@1?20TRAY"+CR	Open	"@120OPEN"+CR
		Close	"@120CLOS"+CR
Play Mode	"@1?20PLAY"+CR	Toc Reading	"@120TOCR"+CR
		Stop	"@120STOP"+CR
		Play	"@120PLAY"+CR
		Pause	"@120PASE"+CR
		FF	"@120FASF"+CR
		REW	"@120FASF"+CR
Disc	"@1?20DISC"+CR	No Disc	"@120NODI"+CR
		ERROR	"@120ERDI"+CR
		CDDA	"@120CDDI"+CR
		MP3	"@120MPDI"+CR
Repeat Mode	"@1?20RPTM"+CR	OFF	"@120RTOF"+CR
		ON	"@120RTON"+CR
		ALL	"@120RTAL"+CR
		A-	"@120RTA-"+CR
		A-B	"@120RTAB"+CR
Time Mode	"@1?20TMOD"+CR	Track	"@120TTTRA"+CR
		Track Remain	"@120TTTRE"+CR
		Total Remain	"@120TTREM"+CR
		Total Lap	"@120TTTLA"+CR
Album	"@1?20ALBU"+CR		"@120Axxx"+CR
Track	"@1?20TRAC"+CR		"@120Txxx"+CR
Current Display Time	"@1?20TIME"+CR		"@120Xxxx"+CR

Request Command for TAPE		Response from TAPE	
Power	"@1?18POWE"+CR	Standby	"@118POFF"+CR
		Power On	"@118PRON"+CR
Cassette	"@1?18CASS"+CR	IN	"@118CAIN"+CR
		Eject	"@118CAEJ"+CR
Play Mode	"@1?18PLAY"+CR	Stop	"@118STOP"+CR
		Play FW	"@118PLFW"+CR
		Play REV	"@118PLRV"+CR
		Pause	"@118PASE"+CR
		FF	"@118FASF"+CR
		REW	"@118FASR"+CR
		Cue	"@118CUE_ "+CR
		Review	"@118REVI"+CR
		REC	"@118RECO"+CR
		REC Pause	"@118RECP"+CR
Current Time Display	"@1?18TIME"+CR		"@118xxxx"+CR
Memo	"@1?18MEMO"+CR	OFF	"@118MEOF"+CR
		ON	"@118MEON"+CR

Hand shake flow chart for Commands Requesting Status:

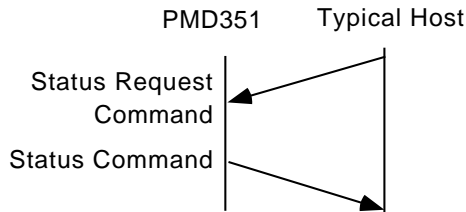

Category	Status from TAPE	
Power	Standby	"@118POFF"+CR
	Power On	"@118PRON"+CR
Cassette	IN	"@118CAIN"+CR
	Eject	"@118CAEJ"+CR
Play Mode	Stop	"@118STOP"+CR
	Play FW	"@118PLFW"+CR
	Play REV	"@118PLRV"+CR
	Pause	"@118PASE"+CR
	FF	"@118FASF"+CR
	REW	"@118FASR"+CR
	Cue	"@118CUE_ "+CR
	Review	"@118REVI"+CR
	REC	"@118RECO"+CR
	REC Pause	"@118RECP"+CR
Memo	OFF	"@118MEOF"+CR
	ON	"@118MEON"+CR

Hand shake flow chart for automatic status data:

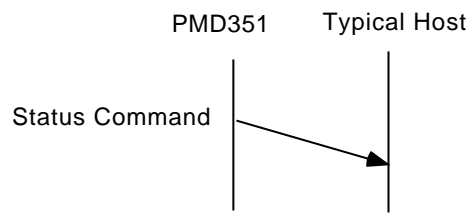

**Status changes automatically transmitted.**

The following status codes are automatically transmitted to the host.

Category	Status from CD	
Power	Standby	"@120POFF"+CR
	Power On	"@120PRON"+CR
Tray Mode	Open	"@120OPEN"+CR
	Close	"@120CLOS"+CR
Play Mode	TOC Reading	"@120TOCR"+CR
	Stop	"@120STOP"+CR
	Play	"@120PLAY"+CR
	Pause	"@120PASE"+CR
	FF	"@120FASF"+CR
Disc	REW	"@120FASR"+CR
	No Disc	"@120NODI"+CR
	ERROR	"@120ERDI"+CR
	CDDA	"@120CDDI"+CR
Repeat Mode	MP3	"@120MPDI"+CR
	OFF	"@120RTOF"+CR
	ON	"@120RTON"+CR
	ALL	"@120RTAL"+CR
	A-	"@120RTA-"+CR
Time Mode	A-B	"@120RTAB"+CR
	Track	"@120TTRA"+CR
	Track Remain	"@120TTRE"+CR
	Total Remain	"@120TTREM"+CR
	Total Lap	"@120TTLA"+CR

**RS-232C specifications:**

Connector pin assignment

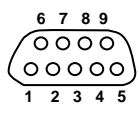

pin	use	PMD351	Typical Host
1	NC	Not Connected	Not Connected
2	TX	Transmit Data	Receive Data
3	RX	Receive Data	Transmit Data
4	NC	Not Connected	Not Connected
5	GND	Ground	Ground
6	NC	Not connected	Not connected
7	RTS	RS receive	RTS send
8	CTS	CS send	CTS receive
9	NC	Not Connected	Not Connected

cable connector      D-Sub 9 pin (male)      D-Sub 9 pin (female)

**Physical specifications**

Cable	Straight cable
Baud rate	9600 bps
Data bits	8 bits
Parity bit	None
Stop bit	1 bit
Flow control	CR/RS Hardware Flow

## CS/CR hardware flow control

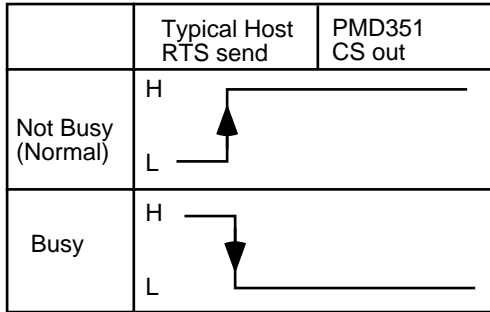

### Timing chart

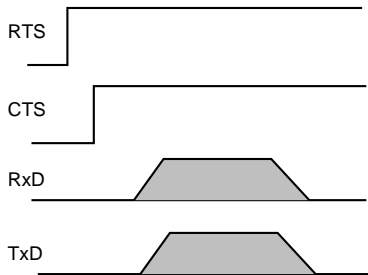

### Control commands:

The control command packets have a data length of 7~10 bytes. ASCII codes from 0x00 to 0x7f are used to receive serial data. At the transmission end, take steps to convert the ASCII codes into HEX data to set the data in the data packets. CR (0x0d) is added as the data packet delimiter.

Example: Reception Time command (ASCII code @12011)

@	1	2	0	1	1	CR
0x40	0x31	0x32	0x30	0x31	0x31	0x0d

When transmitting commands consecutively, put more than 100ms blank between commands.

### Status data transmission:

The status data packets have a fixed data length of 8 bytes. ASCII codes from 0x00 to 0x7f are used to transmit serial data. For this reason, the ASCII codes are converted into HEX data before the data is set in the data packets and transmitted. CR (0x0d) is added as the data packet delimiter.

Example: Transmission "Power ON" (ASCII code @120PRON)

@	1	2	0	P	R	O	N	CR
0x40	0x31	0x32	0x30	0x50	0x57	0x4f	0x4e	0x0d

## RC-5 CODES

If you have a remote control Model RC30, (not supplied – available from Marantz Professional) this unit receives the codes listed in the table below from the infrared remote control sensor (11) on the front of the unit.

### Remote control codes (RC-5)

Command	Code	
	CD Player	Tape Deck
0	2000	1800
1	2001	1801
2	2002	1802
3	2003	1803
4	2004	1804
5	2005	1805
6	2006	1806
7	2007	1807
8	2008	1808
9	2009	1809
Time	2011	
Recall	2015	
Repeat	2029	
Next	2032	1832
Previous	2033	1833
Pitch Reset	2037	
Pitch Up Start	2038	
Pitch Up Stop	203801	
Pitch Down Start	2039	
Pitch Down Stop	203901	
Program/Memo	2041	1841
AMS	2043	1843
Open/Close	2045	
Pause	2048	
Clear	2049	
Fast Backward Start	2050	1850
Fast Backward Stop	205001	
Fast Forward Start	2052	1852
Fast Forward Stop	205201	
Play	2053	1853
Stop	2054	1854
A-B	2059	
Direction		1847
REC Mute		1842
REC		1855

**CARE AND MAINTENANCE**

**Head Cleaning**

If the heads are not cleaned for a long period, dirt or dust may be deposited on the heads and capstans, causing degraded high-frequency characteristics, volume drop, or degraded recording and erasure performances. To prevent this, clean the heads, capstans, etc., periodically as follows.

1. Turn the power off.
2. Open the cassette holder by pressing the EJECT button.
3. As shown, clean the parts which come in contact with tape, including the heads, capstans, tape guides, pinch wheels, etc., with a cotton swab soaked in head cleaning solution.

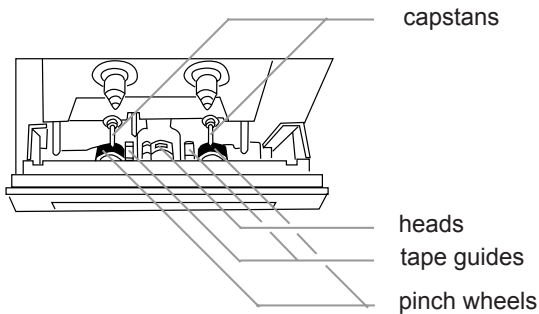

**Head Demagnetization**

When a magnetized metallic object (such as a screwdriver tip) comes in contact with a head or capstan, or when the deck has been used for a long period of time, the head may be magnetized and noise may be generated. If the head is extremely magnetized, the high frequencies in recorded tapes could even be erased. To prevent this, demagnetize the heads and capstans periodically (every 20 hours of use) using a commercially available head demagnetizer. (For this operation, please refer to the instruction manual supplied with your head demagnetizer.) Caution: Be sure to turn the power of the cassette deck off before using a head demagnetizer.

**CLEANING EXTERIOR SURFACES**

The exterior finish of your unit will last indefinitely with proper care and cleaning. Never use scouring pads, steel wool, scouring powders or harsh chemical agents (e.g., lye solution), alcohol, thinners, benzene, insecticide or other volatile substances, as these will mar the finish of the equipment. Likewise, never use cloths containing chemical substances. If the equipment gets dirty, wipe the external surfaces with a soft, lint-free cloth.

If the equipment becomes heavily soiled:

- dilute some liquid soap in water, in a ratio of one part detergent to six parts water
- dip a soft, lint free cloth in the solution and wring

the cloth out until it is damp

- wipe the equipment with the damp cloth
- dry the equipment by wiping it with a dry cloth.

**COMPACT DISCS**

The glossy side (shining like a rainbow) is the front side of the disc; and; the side on which the label is printed is the back. Unlike conventional turntables for playing analog discs, compact disc players read the information recorded on the disc from underneath without contacting it, using a beam of laser light. Therefore, the performance of a compact disc will not degrade like conventional analog records.

Handle discs carefully so as not to damage or scratch the front side.

To protect the disc, avoid placing it in the following locations:

- In direct sunlight or near a source of heat like a heater.
- In a place which is damp or dirty.
- In a place which could be exposed to rain, such as near a window.

**Always keep the disc surface clean.**

Up to six billion data units are recorded on the front side of the disc. When cleaning the disc surface, always be sure to use a special compact disc cleaner and wipe as shown below.

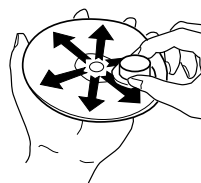

Wipe in a radial direction.

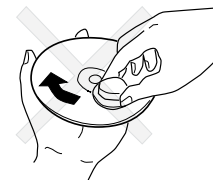

Do not wipe in circumferential direction.

Do not use conventional record cleaner for analog records, as this will adversely affect the disc surface. Store discs properly by placing them in their disc cases.

## TROUBLESHOOTING

Should faults occur, it is in many cases not necessary to consult your dealer or technical service department. On the basis of the following checks, you will be able to rectify a number of conditions yourself without difficulty. If the condition cannot be remedied after the following check, please consult your dealer or nearest Marantz Professional service agent.

### TAPE DECK

The tape does not travel. Check that:

1. the power cord is plugged in properly.
2. the POWER switch is set to ON.
3. the tape is rewound.

The tape travels, but no sound is heard. Check that:

1. the cassette tape is recorded.
2. the mixer, amplifiers and speakers are connected and functioning properly.

Tape will not record. Check that:

1. the protection tabs of the cassette tape are not broken.
2. the recording level is set properly.

Sound is distorted. Check that:

1. the recording level is not too high.
2. the head is not dirty.

Sound is unstable. Check that:

1. the head is not dirty.
2. the pinch wheels and capstans are not dirty.
3. the tape is wound regularly.

Noise is noticeable. Check that:

1. the head is not dirty.
2. the head is not magnetized.
3. the DOLBY NR switch is set properly according to the tape.

Hum interferes with the sound. Check that:

1. cords are connected properly.
2. there is not any source of magnetism (TV, motor, transformer, etc.) placed near the unit.
3. When this unit and amplifier are stacked, hum noise is sometimes generated depending on the amplifier model. In such a case, place the components in positions where interference does not occur.

### CD PLAYER

The disc falls to rotate. Check that:

1. the power cord is plugged in properly.
2. the POWER switch is set to ON.
3. the disc is placed in the correct position on disc tray.
4. the disc is placed properly with the label side facing up.
5. the disc is not dirty.
6. the disc is not scratched.
7. the disc is not warped.
8. the transport screws have been removed.

The disc is rotating but no sound is heard. Check that:

1. the amplifier and speakers are connected properly.
2. the amplifier is turned ON.
3. the amplifier's volume control is not set at the minimum level.
4. the amplifier's input selector switch is set to the correct input ('CD' or 'AUX' whichever corresponds to the input jacks the CD player is connected to).

The disc stops in mid-operation. Check that:

1. the disc is not dirty.
2. the disc is not scratched.
3. the disc is not warped.

The sound drops out or noise is heard. Check that:

1. the disc is not dirty.
2. the disc is not scratched.
3. the disc is not warped.

**SPECIFICATIONS\*****TAPE DECK**

Track system ..... 4 Track, 2 Channel  
 Record/Erase system ..... AC 105 kHz Bias  
 Head System (Rotary type combination)  
 Rec/Play ..... Hard metal alloy  
 Erase ..... Dual gap ferrite

**Motor System**

Capstan ..... DC Servo Control  
 Reel ..... DC  
 Wow and flutter ..... 0.14% W-RMS

**Frequency Characteristics**

Frequency response (no Dolby NR)  
 type I (Normal position) ..... 30Hz-15kHz  $\pm$  3dB  
 type II (High position) ..... 30Hz-16kHz  $\pm$  3dB  
 type IV (Metal position) ..... 30Hz-16kHz  $\pm$  3dB  
 Overall S/N (no Dolby NR, IEC-A WTD)  
 type I (Normal position) ..... 53dB  
 type II (High position) ..... 53dB  
 type IV (Metal position) ..... 53dB

Dolby NR effect (B/C S/N improvement,  
 CCIR-ARM WTD) ..... 9dB/18dB  
 Output level ..... 1 k $\acute{y}$   
 Input  
 TAPE in ..... 100mV/47k $\acute{y}$   
 MIC in ..... 0.5mV/10k $\acute{y}$

**CD PLAYER**

Channels ..... 2 channels  
 Sampling frequency ..... 44.1kHz  
 Quantization ..... 16-bit linear/channel  
 Error correction ..... Cross-interleave read  
 solomon code (CIRC)  
 D/A conversion ..... 1-bit linear/channel  
 Wow & flutter ..... Precision of quartz

**Optical Readout System**

Laser ..... CaAlAs semiconductor  
 Wavelength ..... 780nm

**Frequency Characteristics (Pitch control off)**

Frequency response ..... 20Hz-20kHz  $\pm$  0.3dB  
 Dynamic range ..... 90dB  
 S/N ratio ..... 96dB  
 Channel separation ..... 90dB  
 Distortion (THD 1kHz) ..... 0.005%  
 Analog output  
 Output level ..... 2V RMS  
 Output impedance ..... < 1k $\acute{y}$   
 Digital output  
 Coaxial output (75 $\acute{y}$  loaded) ..... 0.5 Vp-p

**COMMON PARTS**

Power supply ..... 120 VAC/50Hz

**Dimensions**

Width ..... 483mm  
 Height ..... 133mm  
 Depth ..... 280mm

Net Weight ..... 6.8kg

These specifications represent design standards. Higher levels of performance can be expected under most conditions.

\*Subject to change without notice.



# CONNECTIONS

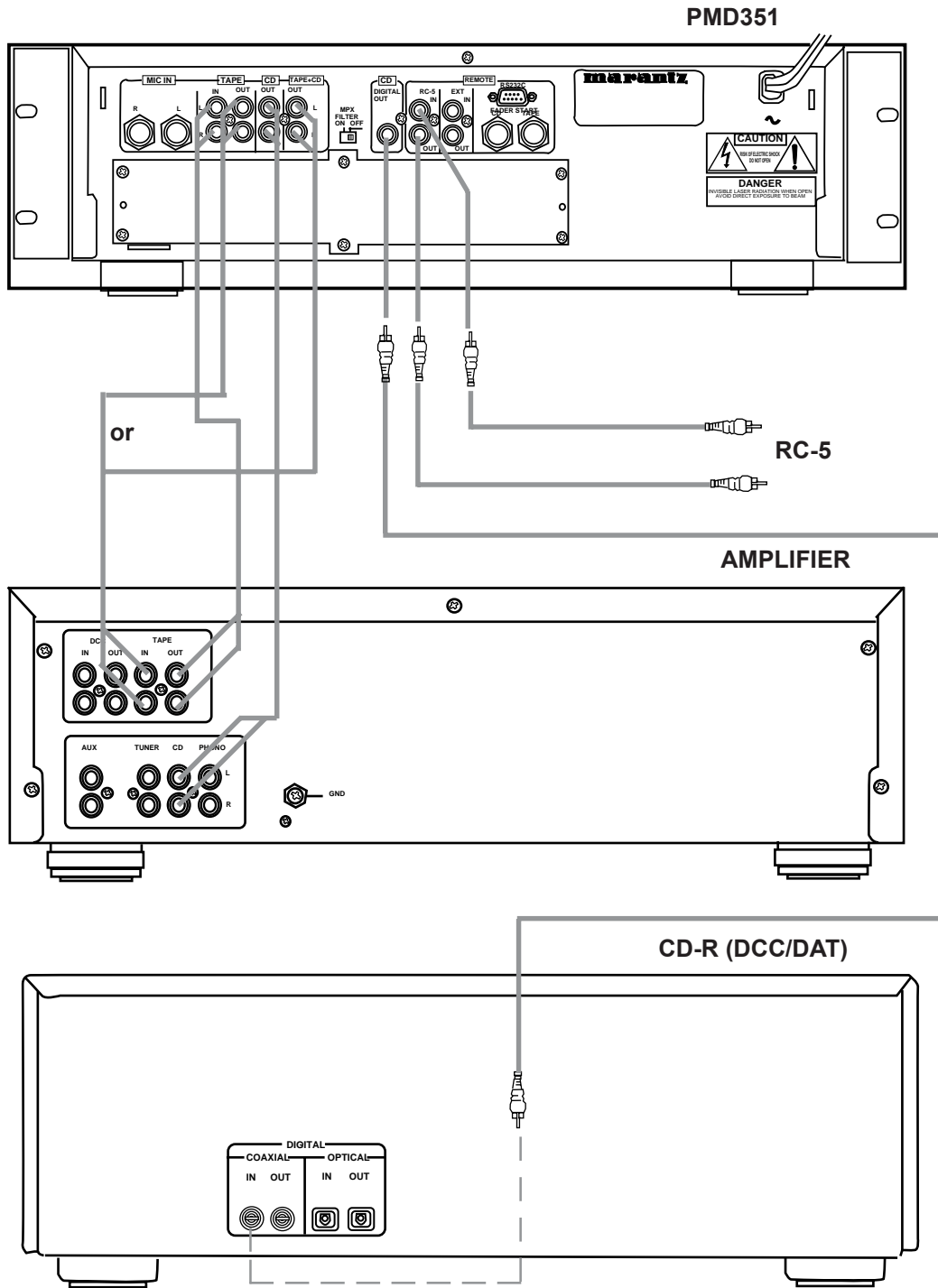

The RC-5 connections shown enable Marantz Professional cascade operation.

**CAUTION**

The TAPE + CD OUT should be connected to TAPE IN of the amplifier. If this output is connected to another input and the amplifier's input selector is set to this input, oscillation may occur when the PMD351 is set to record which could damage the speakers.

## LIMITED WARRANTY

Your Marantz Professional product is warranted against manufacturer defects in material and workmanship for a period of one year parts and labor.

Except as specified below, this warranty covers defects in material and workmanship. The following are not covered under warranty:

1. Damage, deterioration, malfunction or failure to meet performance specifications resulting from:
  - a) Accidents, acts of nature, misuse, abuse, neglect or unauthorized product modification.
  - b) Improper installation, removal or maintenance, or failure to follow supplied instructions.
  - c) Repair or attempted repair by a non-Marantz authorized agent.
  - d) Any shipment (claims must be presented to the carrier).
  - e) Any cause other than a defect of manufacturing.
2. Cleaning, check-ups with no fault found or changes incurred for installation, removal or reinstallation of the product.
3. Any serialized product on which the serial number has been defaced, modified or removed.
4. Batteries and battery chargers.
5. Accessories, including but not limited to: cables, mounting hardware and brackets, cleaning accessories, power cords and adapters, and carry cases.
6. Products purchased outside of the United States, its possessions or territories.

### Non-transferable warranty

This Warranty may be enforced only by the original purchaser.

### What We Will Pay For

We will pay for all labor and material expenses for items covered by the warranty.

### How You Can Get Service

1. If your unit needs service in the USA, contact our service referral at the appropriate telephone number indicated below. We will advise you of the name and location of one or more authorized service centers from which service may be obtained. Please do not return the unit directly to us.
2. You must pay any shipping charges if it is necessary to ship the product for service. If the necessary repairs are covered by the warranty, we will pay return shipping charges to your location anywhere in the United States or its territories.
3. Whenever warranty service is required, you must present the original dated sales receipt or other proof of date purchased.

### Limitation of Implied Warranties

All implied warranties, including warranties of merchantability and fitness for a particular purpose, are limited in duration to the length of this warranty.

### Exclusion of Damages

Liability for any defective product is limited to repair or replacement of the product at manufacturer's option. Manufacturer shall not be liable for damage to other products caused by any defects in Marantz products, damages based on inconvenience or loss of use of the product, or any other damages, whether incidental, consequential, or otherwise.

Some States do not allow limitations on how long an implied warranty lasts and/or do not allow the exclusion or limitation of incidental or consequential damages, so the above limitations and exclusions may not apply to you.

### How State Law Relates to the Warranty

This warranty gives you specific legal rights, and you may have other rights which may vary from State to State.

### Marantz Professional Service Number:

Marantz Professional Factory Service (630) 741-0330

This warranty is enforceable only in the United States and its possessions or territories.

**marantz**® Marantz is a registered trademark.

