

Haier

Haier Refrigerators





Model: PBFS21****







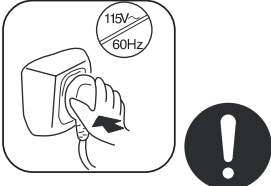
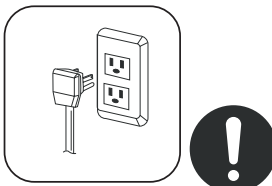

RBFS21****

CONTENTS

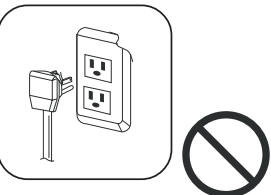

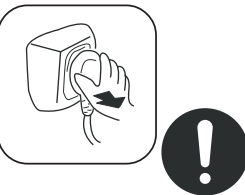
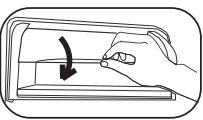

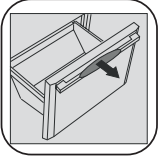







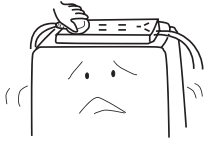



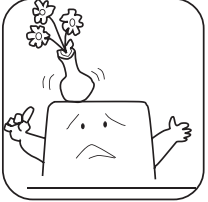







Safety Precautions.....	1-2
Location	3
Features	3
Components	4
Removing and Installing the Doors	5-6
Connecting the Water Supply Line	7-8
Preparation before use.....	9
Usage	10
Function	10-14
About the Fresh Food Compartment	15-16
Precaution when Refrigerating Food.....	16
Tips and Hints in Using Fresh Food Compartme.....	17
About the Freezer	17
Precaution when Freezing Food.....	18
Usage of Ice Maker and the Cold Water Dispenser ...	18-19
Removing and Installing the Ice Container	19
Usage of the Dispenser.....	20
About the Convertible Compartment.....	20
Defrosting Cleaning	20
Water Filter.....	21-22
Shutting off the Refrigerator.....	23
Troubleshooting	24-27
Limited Warranty	28

Safety Precautions



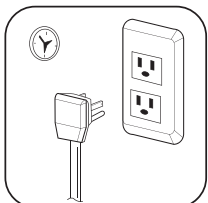

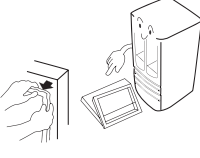

 WARNING	<p>Before operating the appliance, please thoroughly read and retain this manual for your reference. Because we offer a variety of models, the characteristics of your refrigerator may differ slightly from those described in this manual.</p> <p>The appliance is not intended for use by children or infirm persons without adult supervision. Children should be supervised to ensure that they do not play with the appliance.</p>
 WARNING	<p>Indicates that a danger of death or serious injury exists.</p>
 NOTE	<p>Indicates that a risk of personal injury or material damage exists.</p>
	<p>Represents something you must follow.</p>
	<p>Represents something you must not do.</p>

<p>This refrigerator uses AC 115V/60Hz power Large voltage fluctuation may cause no start-up of the refrigerator, burning of main control board and compressor or abnormal noise in the compressor, in such case, an auto stabilizer is needed.</p> 	<p>A separated socket is a must and reliable earthing is needed as well This refrigerator adopts three-prong (earthing) plug, which can be used on standard three-prong (earthing) socket. In any case, cutting off or dismantling the third pin (earthing) is prohibited. After the refrigerator is installed, the plug shall be reachable.</p> 	<p>Do not damage the power cord</p> <ul style="list-style-type: none"> ● Do not disconnect the power cord by pulling on it. Hold the plug, draw it out from the socket directly. ● Refrigerator pressing the cord is not allowed, and do not step on the cord. ● When you move the refrigerator away from wall, be careful and avoid rolling and pressing the cord. 
<p>In case power cord is damaged If the cord or the plug is worn stop using it. Contact a service engineer to replace it.</p> 	<p>In case there is flammable gas leakage</p> <ul style="list-style-type: none"> ● Shut the valve where there is gas leakage. ● Open doors and windows. ● Do not pull out or insert the power plug of the fridge or any other appliances. 	<p>Unplug the fridge in the following cases</p> <ul style="list-style-type: none"> ● Before clean or maintain the refrigerator, unplug the fridge. ● Before changing bulb, unplug the fridge to prevent potential shock. 
<p>When you open or close the Dairy Bin, please do so as shown to prevent pinching finger.</p>   		<p>Do not pull Convertible Drawer with too much force to avoid food falling out. Do not put too much food in the Convertible to prevent non-stop of compressor and food falling.</p>  

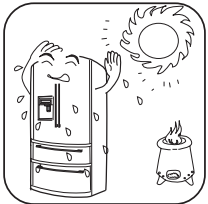
Safety Precautions

<p>Flammable, explosive dangerous articles and high corrosive acid and alkali must not be put in the fridge.</p>  	<p>Drug, vaccine and chemical reagent shall not be put in the fridge, this fridge is only for household usage, and it cannot store temperature-sensitive materials.</p>  	<p>Do not store or use petrol or other flammable near the fridge to avoid fire hazard.</p>  
<p>Don't put unstable material on the fridge such as heavy the containers with water to avoid personal injury. Do not put the contain of water on refrigerator</p>  	<p>Do not play or hang on the bottle bin inside the door, which may lead to damage of the bottle bin, falling down of the fridge and eventually personal injury; Do not step on the convertible drawer while adding or removing food</p>  	<p>While the fridge is in operation, do not touch the frozen surface of the freezer, especially with wet hands to prevent frostbite.</p>  
<p>The gaps among doors and cabinets are small. Please do not put your finger in gaps. While opening or closing the fridge doors, keep children away from the fridge</p>  	<p>Do not spray or rinse the fridge, and do not put the fridge in a humid place. This will prevent damage to the electrical and performance of the fridge from water exposure</p>  	<p>Dismantling or modification the fridge is prohibited. Damage to the cooling piping is also not allowed. Any repair work must be done by a service engineer or technician.</p>  
<p>Do not put the bottled beer or soft drinks in the freezer to avoid broken glass; You also must not put these beverages in the convertible compartment when it is being used as a freezer.</p>  	<p>During a power failure or when cleaning, put out the plug at least 5 minutes, otherwise it may cause continuous start-up and damage the compressor. You must wait at least 5 minutes before plugging power plug back in, otherwise it can damage the compressor</p>  	<p>After the fridge is no longer in use, take off the doors, gaskets, and shelves and store them in safe place. This avoids the danger of children playing inside the discarded fridge</p>  

Location

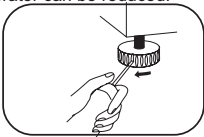
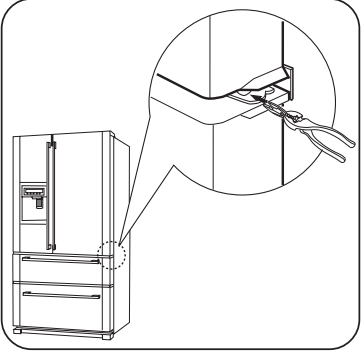
<p>The position of the refrigerator should be far away from heat source and the refrigerator should avoid sunlight point-blank, in case the working performance of the refrigerator may be influenced.</p>  	<p>Don't place the refrigerator at a wet and easy-sprinkled place, and the sprinkled water and the feculence should be cleaned with a soft cloth.</p>  	<p>The refrigerator should be placed a place that is draughty and near a drinking water source, and the around the refrigerator including the back of the refrigerator should be some room of 1 inch.</p>  
<p>The Emendation of the Refrigerator Body The refrigerator should be placed at a flat and steady ground, and if the refrigerator needs to be blocked up, a place that is steady, solid, and incombustible should be chosen, and don't use the package foam underlay of the refrigerator to block up the refrigerator. If the refrigerator is a little unsteady, the flexible bottom foot can be adjusted, so that the height of the refrigerator can be increased; circumvolve the bottom foot in an anticlockwise direction, so that the height of the refrigerator can be reduced.</p> 	<p>Parallel of the Door Bodies If the heights of two door bodies are not in symmetry, please make the door bodies be in symmetry according to the following descriptions.</p> <ol style="list-style-type: none"> 1. At the place of the inter-space gemel, Lift the door to be lifted with one hand. 2. Insert the forceps into the ouch with anther hand, as shown in the figure. 3. Insert the other ouches until the door bodies are parallel. (Three ouches are provided together with the product.) 	

Features

1. Water filter
The water filter has a grant scale amount of depuration, and it is flexible to be changed.
2. Independent ice-taking room
The ice-taking room is pulled out independently, so that the ice-taking becomes convenient.
3. The refrigerator is designed to be thin, lazrge, and luxurious.
4. Freon -free or oxygen-free, full-wind refrigerant system, deep refrigeration and quick freezing.
5. Wind-curtain technology
In the front of the top area of the refrigerant room the wind-curtain technology is used, so that the cold air loss can be reduced, and it can also make the cold air distribution is more balanced, In order to assure the freshness of the food.
6. pre-refrigeration before defrosting
Before defrosting, the refrigerator inside temperature is judged, and pre-refrigeration is done, so that the temperature before deepfreeze refrigeration and the temperature after deepfreeze refrigeration cannot differ a lot, and this is for the purpose of the freshness of food and will prevent the temperature in deepfreeze refrigeration increasing.
7. Exception is shown automatically.
8. Door-opening warning.
9. temperature-adjustable cooked food box
The temperature is between -19 and 14 F, and has a function of changing temperature immediately without refrigeration.

Components

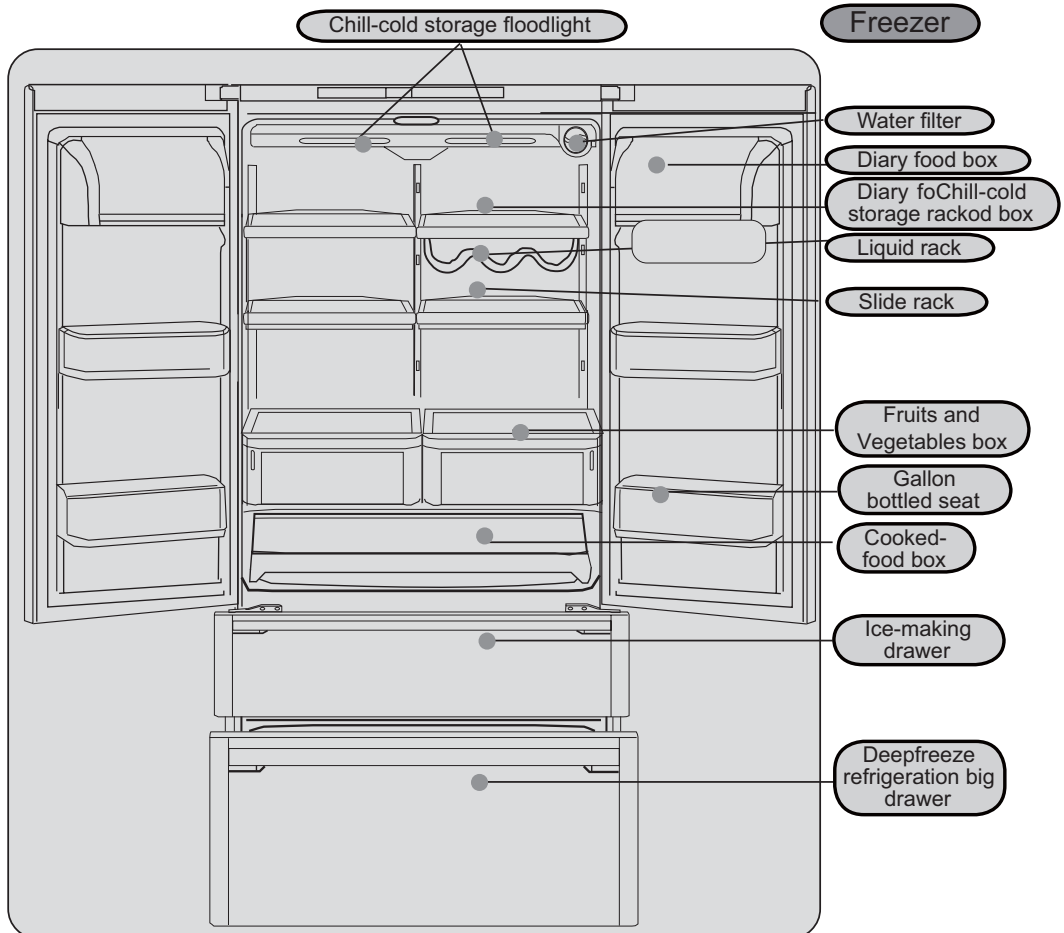

Deepfreeze fridge

Ice spoon

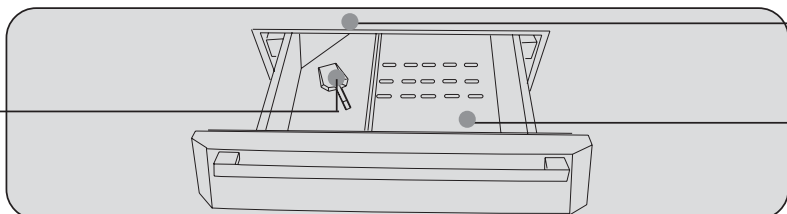

Drawer clapboard

Deepfreeze fridge big drawer

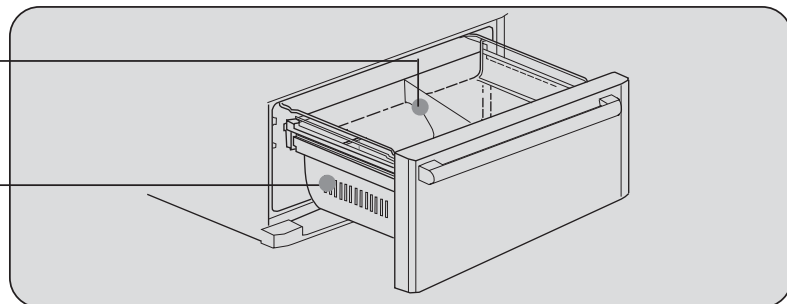

Note For the application of this brochure to different models, the characteristics of the refrigerator you are using may be different from the descriptions in this brochure.

Removing and Installings the Doors



Note

Before the door body installment and dismantlement, please take out the food on the door body rack, dismantle the bottle seat, and then cut the refrigerator off, turn off the water source, in case a life injury, product loss or property loss may be caused. During the door body installment and dismantlement, please ask two or more special persons carry out the following operations in case of the possibility of life injury or r product loss or property loss.

Chill-cold storage Right Door Body Installment and Dismantlement

1. Dismantle the bolts on decorating articles of the refrigerator body, and then take decorating articles off the refrigerator body.
2. Please dismantle the bolts using a screwdriver, and take the up gemel, and then take the refrigerant door body off and place it at a proper position.

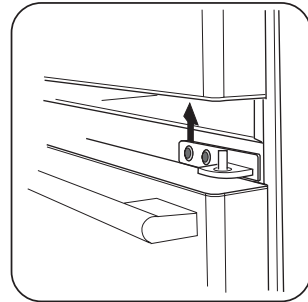
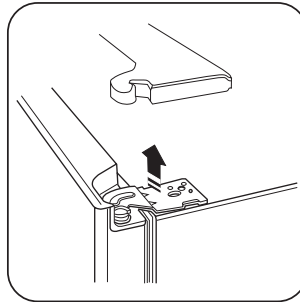
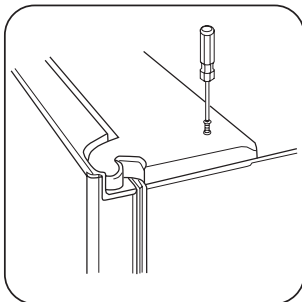

3. Please dismantle the middle gemel if needed.

4. Install the refrigerant door body in a direction that is converse to the above direction.

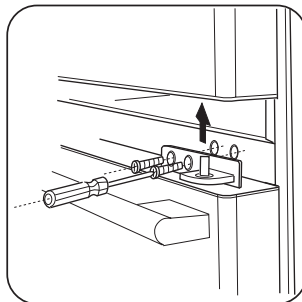

Note

When lifting up the gemel and making it separated from the door body, please prevent the door body slanting forwards.

Chill-cold storage Left Door Body Installment and Dismantlement

1. First carry out the first step of the chill-cold storage door body installment and dismantlement.
2. Cut the power line connecting off and cut the water pipe connecting, dismantle the bolts using a screwdriver, and take the up gemel, and then take the deepfreeze refrigeration door body off and place it at a proper position. (Only for PBFS21EDAW/B/V/S)

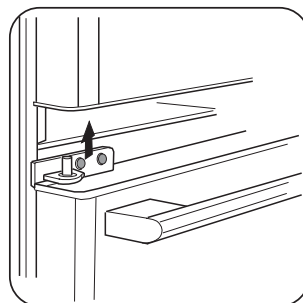
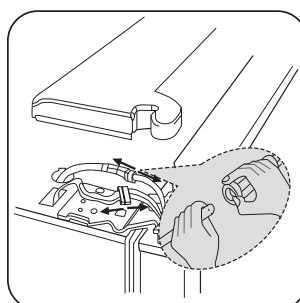
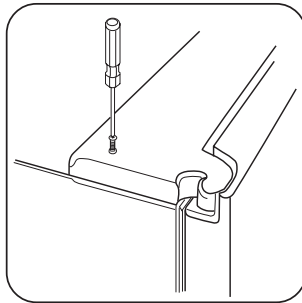

Removing and Installings the Doors

3. Please dismantle the middle gemel if needed.

4. Install the refrigerant door body in a direction that is converse to the above direction.

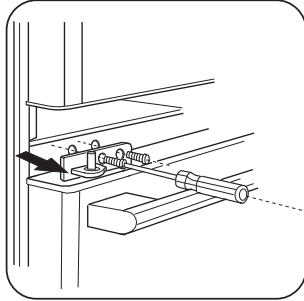

Note When lifting up the gemel and making it separated from the door body, please prevent the door body slanting forwards.

Ice drawer Installment and Dismantlement

1. First open the ice drawer to the great degree, and then pull out the drawer.

2. Moving the blocking buttons with your fingers, and pull out the drawer body hard in the direction shown on the sliding line and place it at the proper position.

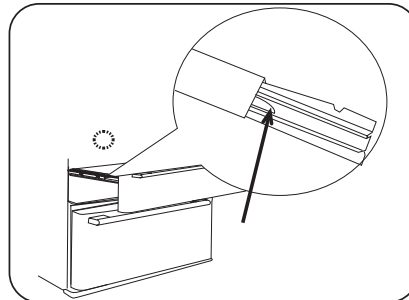
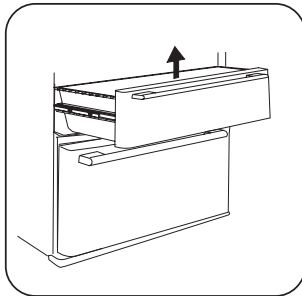

3. Install the ice drawer in a direction that is converse to the above direction.

Deepfreeze refrigeration Big-drawer Dismantlement and Installment

1. First open the ice drawer to the great degree, and then pull out the drawer.

2. Moving the blocking buttons with your fingers, and pull out the drawer body hard in the direction shown on the sliding line and place it at the proper position.

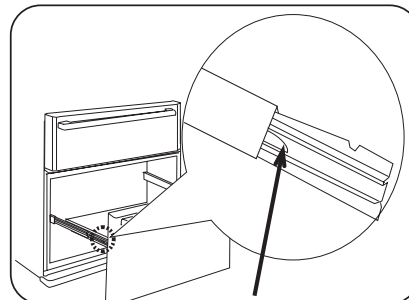
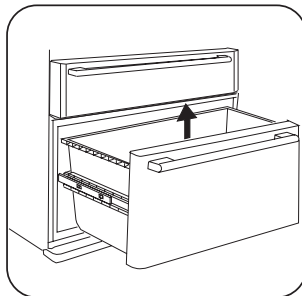

3. Install the ice drawer in a direction that is converse to the above direction.



Note Prevent the danger of keeping the children or pets in, and don't let them play in the drawer.

Connecting the Water Supply Line

Install the stopping valve on the drinking pipe that is frequently used recently.

1. Turn off the main water supplying pipe routine

Turn on the nearest tap till the water pipe is cleaned completely.

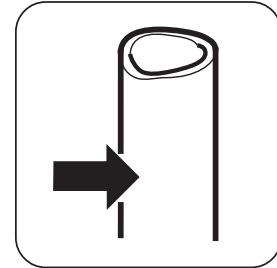

2. Choose the position of the valve.

Choose a position for the valve that is easy to be approached. It is recommended that the valve is connected to the side of a vertical water pipe, and if it is really needed to connect the valve to a level water pipe, connect it to the upside of the water pipe not the downside, in case the sediment may flow out from the water pipe.

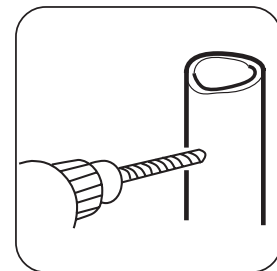

3. The hole of the drill valve

Drill a hole of 1/4 inches on the water pipe using a sharp drill (even using an automatic valve). Clean the burr left on the water pipe by the drill. Not let the water flow into the drill.

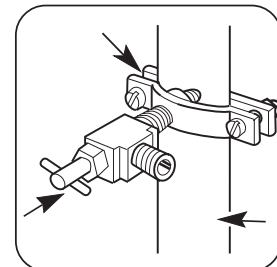

4. Tighten the stopping valve.

Tighten the stopping valve on the cold water pipe using a pipe nip. Follow the rules specified in the 248CMR of Massachusetts Federal Piping Standard. Saddle-backed is unlawful in Massachusetts and is forbidden. Please consult the plumber's mate with working license.

5. Tighten the pipe tip.

Tighten the bolts of the pipe tip till the closing circle begins to expand.

Don't let the bolts of the pipe tip be too tight, otherwise the water pipe is pressed flat.

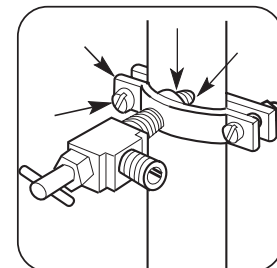

6. The deposing line of the pipe

The deposing line between the cold water pipe and the refrigerator

Drill a hole on the wall or on the floor that is near the wall to a great degree, and let the pipe line go through the hole.

Assure the pipe has an enough margin area(about 8 inches [2.4 meters] and make it be three circles with the diameter of each circle about 10inches[25 centimeters], and after this installment is done, the refrigerator can be moved away from the wall.

Connecting the Water Supply Line

7. Connect the pipe to the valve

Put the Tightened nuts and the copper shaft on the end side of the pipe and connect the pipe to the stopping valve. Make sure that the pipe is cut into the valve completely. Tighten and press the nut.

Follow the descriptions specified in 248CMR of Massachusetts Federal Piping Standard. Saddle-backed is unlawful in Massachusetts and is forbidden. Please consult the plumber's mate with working license.

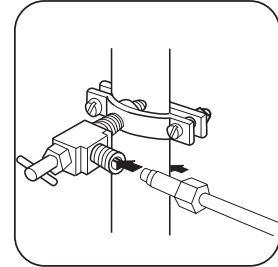

8. Clean the Pipe

Power the main water supply till the water in the pipe becomes clean. Turn off the water valve after having used water of about 1v.

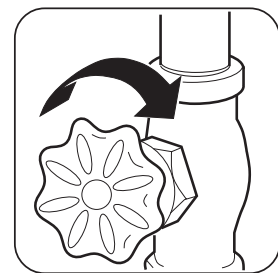

9. Connect the pipe to the refrigerator.



Note

Before connecting the pipe to the refrigerator, make sure that the power line is not cut into the electric plug on the wall.

(1) Tighten the water pipe on the water valve and take the nut off the water pipe.

(2) And then, as shown in the figure, connect the end side of the water pipe to the water valve; tighten the water pipe using tightening nuts.

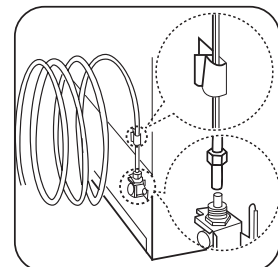

Preparation before Use

1. Dismantle all subassemblies

The foam base seat as well as the adhesive tape as a fixed additional part must be also dismantled.



2. Check all the additional parts and materials with the machine.

The articles in the box must be checked according to the descriptions on the incasement list, and if there is any difference between the description on the incasement list and the actual case, please consult the seller shop for information.



3. Place the refrigerator at a proper position

(See the previous "Position Environment")



4. The installment of the decorating articles at the base.

Open the door of the refrigerant room and from the refrigerant room take out the decorating articles and install them at the proper positions, and drill the bolts.

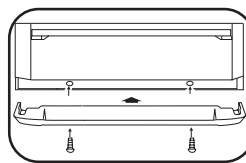

Note

For the convenience of searching information, the number of the refrigerator and the number of manufacturing should be copied on the guarantee issue.

7. It is recommended that before being used the refrigerator should be cleaned first.

Before putting food into the refrigerator, please clean the inside and outside of the refrigerator completely using the baking soda diluted by water (by the ratio of 4L water to a spoon of baking soda).



8. Place the refrigerator without turning on the power.

After the refrigerator is placed at a flat position and cleaned, don't turn on the power immediately, rather you should place the refrigerator for about 6 hours without turning on the power. After at least 6 hours, turn on the power so that the refrigerator can operate well.

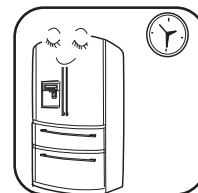

Usage

1. Turn on the power

After turning on the power, the chill-cold storage temperature, the deepfreeze refrigeration temperature will be automatically four levels, and the default value of time is 12:00, and the door body vision board is in the state of unlocking.

3. Put the food into the refrigerator

The refrigerator will be cooled completely after a period of being powered on and operates for a period of time, and then the foods can be put into the refrigerator and the refrigerator is used normally.



2. The operation of the refrigerator

Adjusting way with hands: you may press the temperature adjusting button to design for the operation of the refrigerator (see the following "Instruction of Functions").



NOTE

After the temperature is changed, a balance of the in-box temperatures can only be achieved after a period of time. And the length of this period of time depends on the degree of the change of the temperature, the ambient temperature, and frequency of opening the door, and the amount of stored food in the refrigerator, and so on.

Functions

The door body vision controlling screen

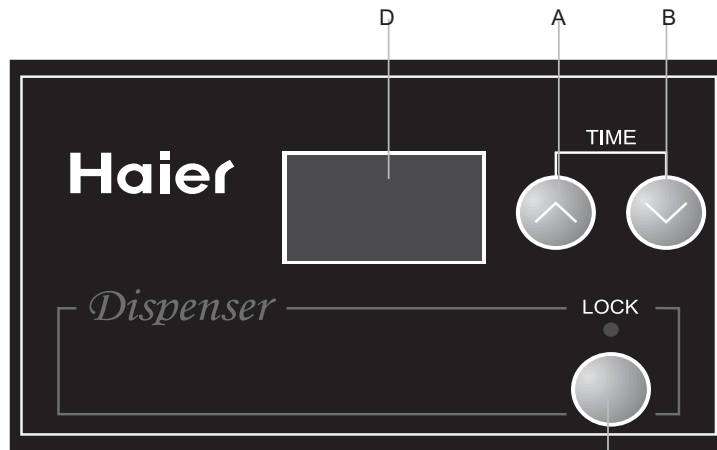

- AHour Button
- BMinute Button
- C..... Lock Button
- D.....Time Area

The Refrigerator Body Vision Controlling Screen

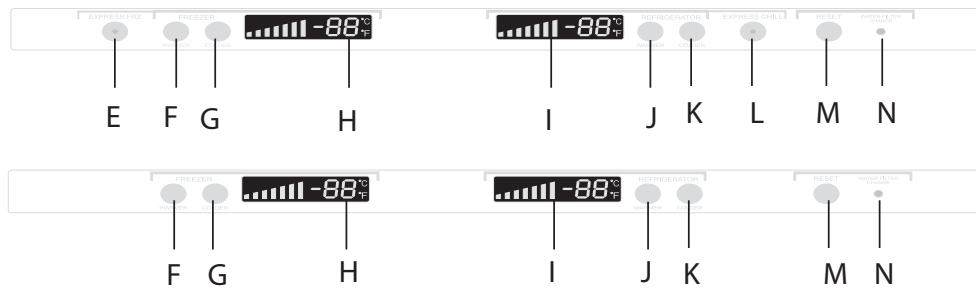

- EQuick-refrigerant button
- Hdeepfreeze fridge temperature indicating area
- J,K.....chill-cold storage temperature adjusting button
- M.....Water filter reset button
- F, G.....Deepfreeze fridge temperature adjusting button
- I.....Chill-cold storage temperature indicating area
- L.....Chill-cold storage quick-deepfreeze fridge
- N.....Water filter indicating lamp

Functions

(1) Lock and Unlock

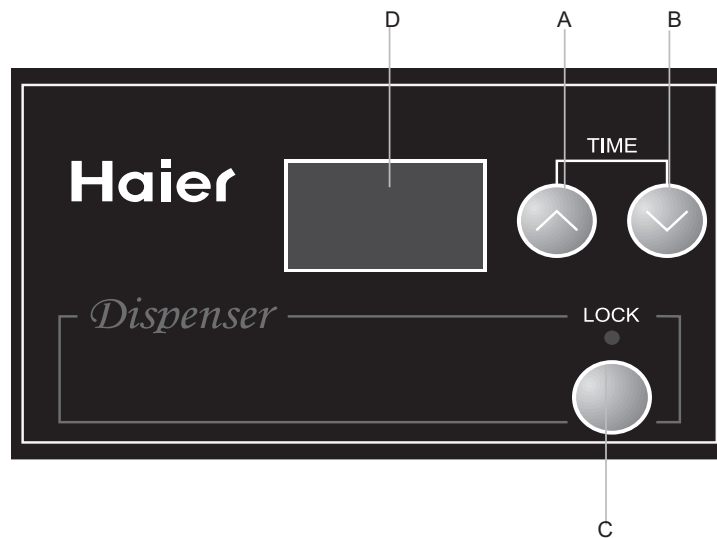

Press Button C, after the first sound of the buzzer, fix the indicating lamp to be lighted, and the clock setting of the door body vision cannot be operated, and the function of taking out cold drinks is locked; press Button C again, after the first sound of the buzzer, fix the indicating lamp to be out, and the clock setting of the door body vision operation is recovered.

(2) Chill-cold storage temperature adjustment



(Only apply for the models with the function of taking out cold drinks)



(Only apply for the models without the function of taking out cold drinks)

Press Button J or Button K, the chill-cold storage temperature vision area will flicker, and when the chill-cold storage temperature is set, the range of the chill-cold storage temperature is 34 degrees to 46 degrees, and each time you press Button K, the chill-cold storage temperature will increase a level, till the highest Level Seven is reached; each time you press Button J, the chill-cold storage temperature will decrease a level, till the lowest Level One is reached.

Functions

(3) Deepfreeze fridge temperature adjustment



(Only apply for the models with the function of taking out cold drinks)



(Only apply for the models without the function of taking out cold drinks)

Press Button G or Button H, the deepfreeze fridge temperature vision area H will flicker, and when the deepfreeze fridge temperature is set, the range of the deepfreeze fridge temperature is -7 degrees to 8 degrees, and each time you press Button G, the deepfreeze fridge temperature will increase a level, till the highest Level Seven is reached; each time you press Button F, the deepfreeze fridge temperature will decrease a level, till the lowest Level One is reached.

(4) Door body vision time adjustment

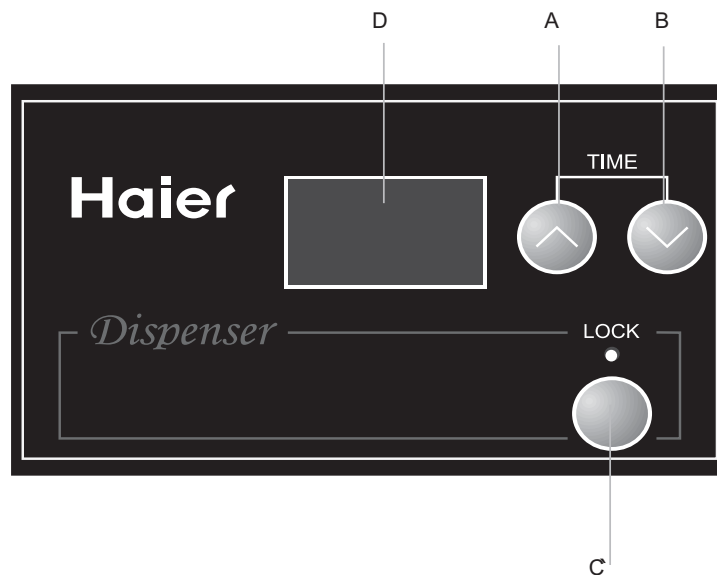

When pressing Button A and Button B at the same time for three seconds, the time sign D will begin to flicker after the first sound of the buzzer. Press Button A to adjust the hours, each time you press Button A, one hour will be increased, till 23 hours is reached, then press Button A again, 00 will be shown. Press Button B to adjust the minutes, each time you press Button B, one minute will be increased, till 23 minutes is reached, then press Button B again, 00 will be shown.

Functions

(5) Refrigerant quick-deepfreeze refrigeration setting



The function of quick-deepfreeze refrigeration is to refrigerate the food completely in the shortest time. Press Button E, the refrigerant quick-deepfreeze refrigeration button indicating lamp will be lighted, and the refrigerator will be in the refrigerant quick-deepfreeze refrigeration state, and the refrigerator will be out of the refrigerant quick-deepfreeze refrigeration state after it enters the refrigerant quick-deepfreeze refrigeration state for 4 hours; if you want the refrigerator to be out of the refrigerant quick-deepfreeze refrigeration state forcefully after it enters the refrigerant quick-deepfreeze refrigeration state for three hours, you can press Button E again, and the refrigerant quick-deepfreeze refrigeration button indicating lamp will be out, and the refrigerator will be out of the refrigerant quick-deepfreeze refrigeration state.

(6) Chill-cold storage quick-deepfreeze refrigeration setting



Press Button L, the chill-cold storage quick-deepfreeze refrigeration button indicating lamp will be lighted, and the refrigerator will be in the chill-cold storage chill-cold storage quick -deepfreeze refrigeration state, and the refrigerator will be out of the chill-cold storage quick -deepfreeze refrigeration state if the chill-cold storage temperature is 2 F lower than its designed temperature; if you want the refrigerator to be out of the chill-cold storage quick -deepfreeze refrigeration state, you can press Button L, and the chill-cold storage quick -deepfreeze refrigeration button indicating lamp will be out, and the refrigerator will be out of the chill-cold storage quick -deepfreeze refrigeration state.

Note When the refrigerator is in the refrigerant quick-deepfreeze refrigeration state and in the chill-cold storage quick -deepfreeze refrigeration state, within the set time, the process of refrigerating remain constant without turning off the machine.

(7) Turn on or turn off the chill-cold storage function



When pressing chill-cold storage adjustment Button J and chill-cold storage adjustment Button K at the same time for three seconds, the chill-cold storage sign I will be out after the first sound of the buzzer and the chill-cold storage function is turn off; when pressing chill-cold storage adjustment Button J and chill-cold storage adjustment Button K at the same time for three seconds again, the chill-cold storage sign I will be on after the first sound of the buzzer and the chill-cold storage function is turn on again.

(8) Celsius / Fahrenheit switching function



Press Button F and Button G and Button J on the vision board at the same time for three seconds, the Celsius will be used after the first sound of the buzzer; Press Button F and Button G and Button J on the vision board at the same time for three seconds again, the Fahrenheit will be used after the first sound of the buzzer.

Functions

(9) The indicated meaning of the water filter



(Only apply for the models with the function of taking out cold drinks)

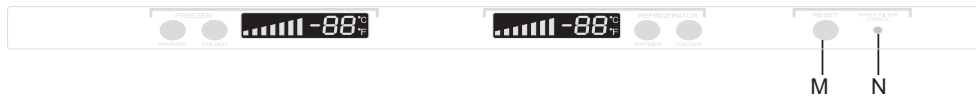

(Only apply for the models without the function of taking out cold drinks)

When the indicating light of the water filter is lighted, it means the water filter should be changed. And after the water filter is changed, please press the water filter reset button M, and the indicating light of the water filter N is out.



When the water filter needs to be changed, please refer to the "water filter" Part.

Note

(10) The function of showing and controlling

30 seconds after Operating the refrigerator by pressing the button, the vision screen is out automatically, and if you press any button or open any door or take out the cold drink, the vision screen will be shown to be on.

(11) Exceptions Indicating

When exceptions on the main controlling function of the refrigerator happen, the exceptions signs will appear on the vision areas of the chill-cold storage or refrigerant temperature, and the exceptions signs are: F1, F2, F3, F5, F6, Ed, ER, E0, E1, E2. If this case really happens, please consult the sold-repairing department to have the refrigerator repaired, in order to test the optimizing controlling of the refrigerator.

(12) Door-opening alarm

When any door body is opened for over 60 seconds, the door-opening alarming function of the refrigerator will be started, and the refrigerator will produce buzzers at the intervals of 30 seconds, which shows to the user that there is a door body is open.

(13) Over-voltage protection

The power of the refrigerator has the function of over-voltage protection. When the function of over-voltage is carried out, the refrigerator will be off automatically, and 5 minutes after the power of the refrigerator is cut off, the refrigerator should be turned on again and then the refrigerator will operate normally.

(14) Power-breaking memorizing function

When the refrigerator is cut off, the state of the refrigerator before the power-breaking is memorized, and then the refrigerator will be operating with the default values before power-breaking.

About the Fresh Food Compartment

• Short-time stored food or the food that is to be eaten at any time should be put into the deepfreeze.

Although the average room temperature of the most area of the chill-cold storage is controlled to be between 33 F and 47 F by adjusting the temperature levels, the food cannot be remained to be permanently fresh, so the chill-cold storage can only be used as the storing room for short-time food.

• The height of the arm-hanging rack can be adjusted.

According to the requirement of the storing food, the height of the arm-hanging rack can be adjusted to be at a proper position.

When adjusting the height of the arm-hanging rack, first the rack should be dismantled. The way of dismantling the arm-hanging rack is: lift the rack by slanting up, and then pull it up, and in this way the rack can be dismantled. When install the arm-hanging rack, put its connecting end into the tank, and at this time, low the head of the arm-hanging rack, and put it into the tank.



Note

Make sure that the two sides of the arm-hanging rack are in a balance, otherwise, the rack may fall down or the food may leak out.

• Fruits and Vegetables Freshness-keeping box and its usage

The refrigerator is designed to include a fruits and vegetables freshness-keeping box, and its inside temperature can be adjusted according to the property of the food to be stored.

• Circumgyrate up the humidity controlling button on the right side of the freshness-keeping box, so that a high temperature can be kept inside the freshness-keeping box, in this case the freshness-keeping box is suitable to store cucumbers, grapes, Chinese gooseberry, persimmon and so on.

• Circumgyrate down the humidity controlling button on the right side of the freshness-keeping box, so that a high temperature can be kept inside the freshness-keeping box, in this case the freshness-keeping box is suitable to store strawberry, oranges, beans, garlic, watermelon, plum, tomatoes and so on.

• When taking out the freshness-keeping box, first make sure that the front side of the freshness-keeping box is on the inside of the freshness-keeping box, and then pull it out. The cover board of the freshness-keeping box can only be taken out after the freshness-keeping box had been taken out. When install the refrigerator, the cover board of the freshness-keeping box should be first installed, and then the freshness-keeping box is installed after that.

• Cooked- food box and its usage

The refrigerator is specially designed to include a cooked-food box, and its inside temperature can be adjusted according to the property of the food to be stored.

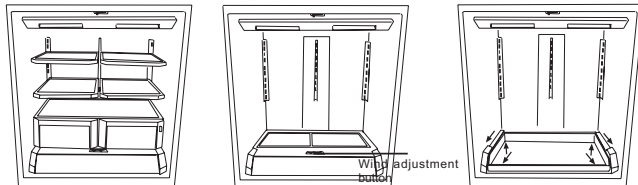

Note: Don't press the wind-adjusting button too hard, in case it may be damaged.

Door-bottled seat height adjustment and cleaning

Lift up the door-bottled seat in the direction of 1, hold the two sides of the door-bottled seat, and pull it out in the direction of 2.

After being cleaned, the door-bottled seat can be installed in the converse direction, and the installment position can be adjusted according to the height of the food to be stored.

Fruits and Vegetables box Cover Board dismantlement

Lift up the rack in the direction of 1, and then pull it out in the direction of 2.



Note

When adjusting the height of the bottle seat, don't put the bottle seat of the dairy room, gallon seat under the door body, in case that the bottle seats may coincide and they may have leakage when the door is closed.

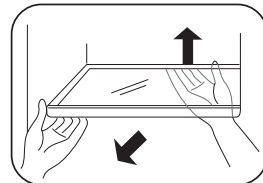
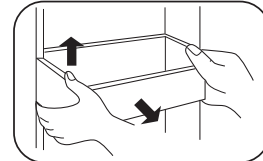
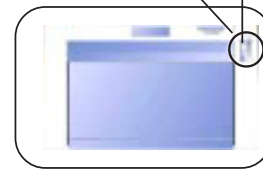
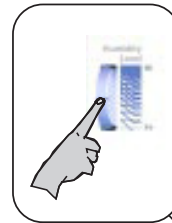
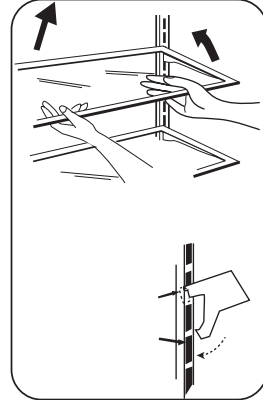
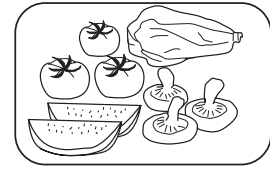



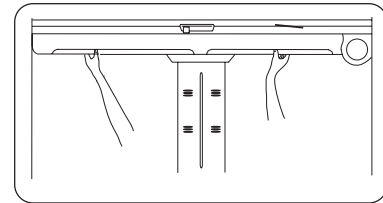
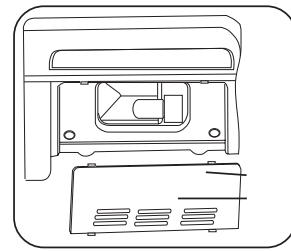
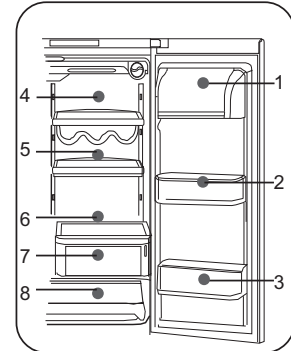

About the Fresh Food Compartment



- The recommended storing space between the foods
Because of the cold air circulation, the temperatures of different areas in the refrigerator are different, so different foods should be stored in areas of different temperatures.
 1. Eggs, butter, cheese and so on.
 2. Tins, cans, condiments and so on.
 3. Drinks and all kinds of bottled foods.
 4. Pickled foods and cans and so on.
 5. Meat foods, articles and so on.
 6. Flour foods, cans and dairy, tofu and so on.
 7. Cooked-meat foods and sausage and so on.
 8. Fruits, vegetables, salad and so on.
- Chill-cold storage Floodlight and its changing
The range of the chill-cold storage floodlight is: 115V-, 40W.
Chill-cold storage floodlight plug: E17 (Never use lamps whose power is over 40W)
When changing the chill-cold storage floodlights:
 1. Pull out the power electric plug, cut the power off.
 1. Use your hands to press the stopping button at the back of the lamp-chimney a little hard, make the stopping button be away from the square hole on the back of the lamp seat.
 2. Then hold the lamp-chimney and pull it back, make the block be away from the square hole.
- Turning down the lamp in an anticlockwise direction, and install a lamp of the same specification in the converse direction.
- Install back the lamp-chimney: cut the block into the square hole, push it in with your hands pressing the back of the lamp-chimney, so the stopping button can be cut into the square hole at the back of the lamp seat.
- Chill-cold storage curtain installment and dismantlement
 1. Dismantle the water filter
 2. Take off the chill-cold storage lamp-chimney, and turn down the lamp.
 3. Turn down the bolts of the fixed curtain using the screwdriver.
 4. Take down the chill-cold storage curtain using hands to press down the chill-cold storage curtain a little hard.
- Installation of the chill-cold storage curtain can be done in the converse direction.

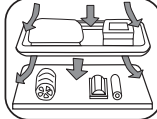
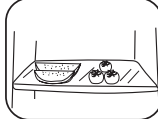

Precaution when Refrigerating Food

<p>Before the hot foods are put into the refrigerator, first they should be cooled till their temperature has reached the room temperature.</p> 	<p>Foods can be put into the refrigerator to be stored only after they have been cleaned and the water drops on it have been cleaned.</p> 	<p>Before the foods are put into the refrigerator to be stored, it is recommended that the foods should be pressurized, so that the water cannot vaporize, and the fruits and the vegetables can keep fresh, and the smells of the foods will not mix together.</p> 
<p>The foods to be stored must be classified. Store the foods independently according to the different kinds of foods. The foods to be eaten daily should be stored in the front of the rack, so that a long time of opening the door should be avoided, and some foods cannot be sour just because you forget their existence.</p> 	<p>The refrigerator to store the foods shouldn't be too full. When you store foods in the refrigerator, you should make sure that there is some space between foods, so that there can be a way that the cold air can go through, and then better deepfreeze refrigeration effectiveness can be achieved.</p> 	<p>When you store the foods, you should make sure that the foods stored in the refrigerator is not too near the inside of the rack, in case the foods may freeze on the back wall of the refrigerator, so when you store the foods, you should make sure that there is at least some space between the foods stored and the inside of the inside wall.</p> 

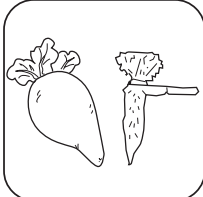
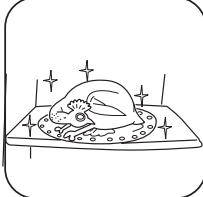
Tips and Hints in Using Fresh Food Compartment

<p>When the radish foods are stored, the leaves of them should be cut off, in case that nutrition may be absorbed by the leaves.</p> 	<p>Put the refrigerant foods into the chill-cold storage to let them defrost, so that you can use chill-cold storage the foods making use of the low temperature of the refrigerant foods to achieve the purpose of economize energy.</p> 	<p>Some foods like onion, garlic, uncooked ginger, water chestnut, and rhizome foods and so on, these foods can be stored at the normal temperature, and they needn't be stored in the refrigerator to deepfreeze.</p> 	<p>Melon, pawpaw, bananas, pineapple, in the state of deepfreeze, its metabolism process can be stimulated, so these foods are not suitable to be stored in the state of the deepfreeze, but the fruits to be stored in the refrigerator are not cooked, you should keep them in the freezer for a period of time, so that it can be recipe.</p> 
--	---	---	--

About the Freezer

- It is suitable to store food for a long time.

The temperature inside the deepfreeze fridge is low, it can keep foods freshness for a long time, therefore, you should store food you intend to keep for a long time in this compartment, and you should follow the storage time indicated on food package.

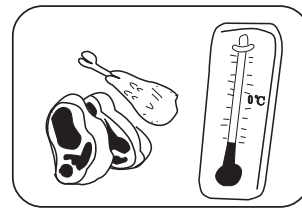

- Lamp and its Replacement in the Freezer Compartment

The range of the chill-cold storage floodlight is: 115V-, 40W.



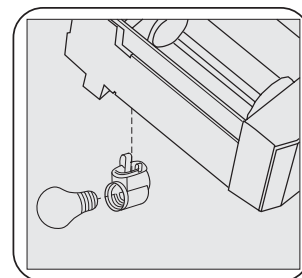

Chill-cold storage floodlight plug: E17 (Never use lamps whose power is over 40W)

While changing the lamp:

- Pull out the plug to cut off the power .
- Lift the lamp-chimney slightly in the direction of 1, and pull it out in the direction of 2.
- Circumgyrate the lamp anticlockwise and make it down, and install a lamp of the same specification.
- Install back the lamp-chimney.

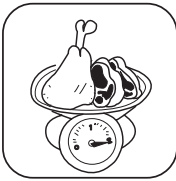

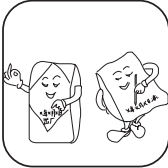
Precaution when Freezing Food

<p>Before the hot foods are put into the refrigerator, first they should be cooled till their temperature has reached the room temperature.</p> 	<p>Divide the foods into small fractions, so it may be easier for the foods to be chill-cold storage completely, and then the quality of the foods during deepfreeze refrigeration and cooking can be checked. And each fraction of the foods should be not more than 2.5 kilograms.</p> 	<p>The foods should be in packages before they are frosted and the surface of their packages must remain dry. In case the packages of the foods to chill-cold storage may freeze to be together. The package material of the foods should be not smelly, airproofed, of innocuity, non-polluted, in case the smells of the foods stored may be mixed and then the quality of the foods stored may be lowed.</p> 
<p>When you store foods, you should indicate the deepfreeze refrigeration period of them in the package bag according to the storing time of different foods.</p> 	<p>Theoretically, take out the foods daily needed from the refrigerant room to let them defrost, and the defrosted foods can not be frosted again, unless they are refined into finished product dish, otherwise the quality of the foods to be eaten may be lowed.</p> 	<p>It is not suitable to put too much fresh foods into the deepfreeze fridge, and it is recommended that the amount of the foods should not be over the deepfreeze refrigeration capacity of the refrigerator.(see "technology data" part)</p> 

Usage of Ice Maker and the Cold Water Dispenser

1.Prepare to use the Ice-making equipment and the cold-water equipment

- The water pipe can be cut into to be a length needed, but it should be assured that the water pipe is not over-curved; the length of the water pipe is normally not less than 5 meters, and if the water pipe is too long, the water supply influenced by the water pressure loss may influence the ice-making amount and the water-outlet amount.
- The water pipe can not stand a high temperature, so it should far away from any source of heat.
- Water supply pipes should be installed and adjusted by special persons.
- When the water supply pipe is first used, press the cold-water button many times in order to supply water for the kettle inside the deepfreeze, and the time of every pressing the button should be about 1 minute (don't press the cold-water button too long each time, in case the water blocking valve may be too hot), till the cold water flow out from the cold water outlet.
- Instructions to the usage of the water supply pipe
 - The water supplying during the automatic ice-making needs to be cooled, and the water pressure is between 21 and 123 psi.
- The water purer is only for filtering, and it cannot do sterilizing or damage any living, so please connect the water pipe to a drinkable water source.

2.NOTE

- Don't install the water pipe of the ice-making machine at a place where the temperature is lower than 32F, in case the water-blocking pipe may freeze.
- Start the water valve, clean the water pipe, and examine whether the connecting end of the water pipe leak water or not till the water is clean.
- When the temperature of the ice-making machine reached 10F or is lower than 10F, the ice-making process begins. (When first using the ice-making machine or not using the ice-making machine for a long time, the first few ice blocks should be thrown away, so that the impurity can flow out from the water pipe.)
- When installing the refrigerator at a proper place, the water supply pipe should be placed properly, in case the water supply pipe may be pressed or damaged which will influence the water-supplying.
- The water filter installed inside the water pipe is for filtering the impurity from the drinking water, and make the made ice blocks be clean and healthy, so the water filter in use will adsorb the impurity in the water. After a long time of usage, if the ice-making capacity is not enough or the ice blocks are too small, it is possible that a blocking has been caused because the filter absorb the impurity in the water. About the refrigerator has been used for about half a year, the indicating light of the water filter will be brighter, which indicates that the water filter should be changed, and at this time, you need to go to the Haier customers serving center or the shop to buy a new water filter to change the old water filter. After the water filter is changed, press the reset button, and then the indicating light will be out. When first installing the refrigerator, the specialties take the responsibility of installing the water filter, and please buy and install the water filter by yourself.
- The ice-making machine installment during installing the refrigerator must be done by the specified repairing department.
- This ice-making machine can only be connected to the drinking water source.

Usage of Ice Maker and the Cold Water Dispenser

3.The operation principle of the ice-making machine.

The ice-making machine will produce 8 ice blocks each time, and the specified ice-making capacity depends on the room temperature, the opening times of the door of the refrigerator, the water pressure, the temperature inside the deepfreeze fridge.

In order to make sure that the storing box is full of ice blocks, the blocks in the ice-meeting drawer should be frequently made to be in a balance distribution.

The ice-making machine will produce 8 ice blocks each time, so the phenomenon that a few ice blocks are mixed together is normal.



Note

The refrigerator newly installed should wait for 24 hours so that the deepfreeze fridge can be cooled for the convenience of ice-making.

If this is your first ice-making machine

You will hear some “poop, poop, poop...” sounds occasionally and they are sounds produced during the ice-making process, so you needn't worry about these sounds.

5.If the ice blocks are not frequently used.

“Old” blocks will become unclean, and the taste will become not so fresh, so please clean the ice blocks storing box, and clean it with hot water. Before you put the ice-cold back into the ice-cold storing box, you must make it cool, and dry it in the sunlight; otherwise the ice will stick to the other parts of the ice-making machine, which will influence the function of ice-making.

6.If the ice storing box is not used for a long time during winter

If the ice storing box is not used for a long time during winter, please take out the ice-colds left in the ice storing box, clean the ice storing box with warm water, clean the water on it, and put it into the refrigerator, and also turn off the water valve between the tap water and the refrigerator.

NOTE:

1. The ice-meeting drawers should be separated using the adjustable clapboard, and the left side of the clapboard is used to store ice, and don't use them to store other articles.
2. When turning on or off the ice-meeting drawer, don't do this too hard, in case the ice-colds may fall on the drawer of the lower layer.
3. When the ice-making machine is operating, there will be ice-making machine operation indicating sign on the door body vision board, at this time, it is recommended that the user not open the ice-meeting drawer till the ice-making operation ended.

Usage of the Dispenser

- The usage of the cold drinks taking-out equipment. (Only for PBFS21EDAW/B/V/S)

Press the cold drinks taking-out button slightly using a cup. As shown in the following figure.

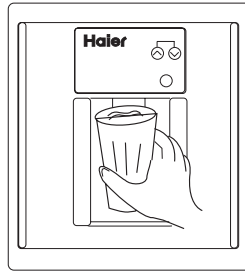

- After you just press the cold drinks taking-out button, you may not gain the cold water, and this is because there is air inside the pipe. Please press the cold-water button for at least 2 minutes, in order to clean out the air inside the water pipe and fill the water pipe with water.
- The first glass of water you take from the water pipe may be hotter than that in the following cups, and this is normal; may be the water will become hotter after two cups, and this is normal.
- The water taken out the refrigerator is cold water not ice, nor the mixture of water and ice blocks. If you need colder water, please put ice-cubes or ice before taking water from the refrigerator.



WARNING

Don't put hands or other articles into the cold-drinks taking out equipment or the ice storing box.

Precautions of Using the Dispenser

- Don't use glasses or paper-cups that are too deep, too thin, too narrow or too weak.
- When you are taking out water from the refrigerator, please keep the glass at the outlet for 5-10seconds after you hands are away from the switch, because then some more water may flow out.
- After getting rid of the water left in the cold drinks taking our plate, dry out the water drops on the cold drinks taking out equipment with a cloth.
- Don't touch the water outlet; otherwise your hands may be hurt.
- Please get rid of the water that you take out for the first several times (about two L), and then the dirty things on the water pipe can be washed away.

About the Convertible Compartment

- When it is used as warm When it is used as cold



Note

1. When you adjust the convertible compartment from fresh food compartment to freezer compartment, put the food in the convertible compartment to fresh food compartment first, open the moveable board, after about 150 minutes, put the food you want to freeze in the convertible compartment, please do not put bottled food or soft-drink in the convertible compartment.
2. When the convertible compartment is changed from freezer to refrigerator, put the food in the convertible compartment to freezer first, close the moveable board, after about 150 minutes put the food you want to refrigerate in the convertible compartment.
3. Don't put fruits and vegetables near the movable board.

● Changing light bulb

Parameter: 115V~, 40W

Socket: E17 (40 plus bulb is prohibited)

While changing the lamp:

- Pull out the plug to cut off power.
- ① Dismount the cover screw.
- ② Press the stopper pin on lamp cover to separate it from the square hole.
- ③ Pull lamp cover forward while holding it to separate jaw from the square hole.
- Turn the lamp counterclockwise to take it down and change a new one

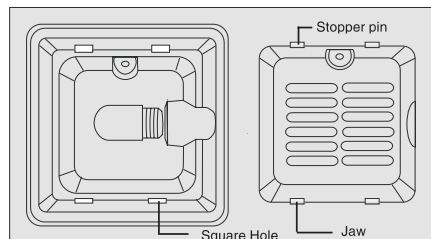

Defrosting . Cleaning

- Defrosting in the deepfreeze fridge

The deepfreeze fridge of this refrigerator will do deepfreeze refrigeration automatically, and you need not make it work by hands.

- Cleaning

The foods left in the refrigerator will produce terrible smell, so the refrigerator should be cleaned regularly.

- For the purpose of safety, please pull out the electric plug out before cleaning.
- Clean the refrigerator using soft towel or sponge with warm water.
- Dry up the water left on the surface of the refrigerator using a dry cloth.



Note

1. The refrigerator is heavy, so when you move it or have it repaired; please protect the surface of the floor. When moving the refrigerator, you must let the refrigerator be vertical, and don't shake the refrigerator, and you can dismantle the adjustable feet or circle up the button to let the refrigerator away from the floor in case the floor may be damaged.
2. When cleaning the refrigerator, don't clean it by sprinkling water on it, in case the electric insulating performance may be influenced.
3. When cleaning the electric parts like the "switch" or the "floodlight", please use a dry duster cloth.
4. Don't use hard brush, steel brush to clean the refrigerator, nor use eradicant, patrol, banana water, hot water or acid, alkali to clean the refrigerator, and to clean the refrigerator you should use scour for special use, in case the refrigerator may be damaged.
5. Don't touch the cold iron surface with your hands, in case your skin may be stuck to the cold iron surface.
6. When cleaning the refrigerator, don't clean the cold glass rack with hot water, in case the glass may break due to the quick change of temperatures, which will cause life injury or property loss.
7. The glue seal used to closing the door is easy to be dirty, so you should make it always be clean.
8. When cleaning the refrigerator and getting rid of the terrible smell, don't use bananas and so on, in case a fire may be caused.

Water Filter

- When the “water filter indicating light” is on.

If the “water filter indicating light” is on, it is indicating that you should change the water filter. You should change the water filter at least every six months or when the water capacity or the ice-making capacity in the distributor has shown an obvious decrease. Please pay attention to your using conditions, and you may need to change the water filter frequently due to the difference between water properties.

- Water filter changing

1. Circle the water filter according to the signs LOCK and UNLOCK signs on the water filter.
2. The water filter leaps slightly from the water filter chimney.
3. Take the water filter off the water filter chimney.



Note

The water may store in the old water filter, which may cause the water flows through the draige holes of the water filter chimney.

4. Take off the protective layer of the new water filter. Cut the new water filter into the water filter chimney, and make the handle of the water filter be at a vertical position. And then push the water filter into the water filter chimney till it cannot push into the water filter chimney further.

5. Circle the handle of the water filter slightly deasil, till it cannot be circled further. The handle of the water filter should be at a level position.

6. After the water filter being changed, turn on the water distributor of the refrigerator for five minutes to clean the water system of the refrigerator. Get rid of the water having been used.

7. After the water filter being changed, reset the vision of the refrigerator.



Note

1. Without the water filter, the water distributor and the ice-making machine cannot be used.
2. About the water filter changing or about the information of your Haier Household Products, you can consult to the local seller or telephone 1-877-337-3639



Note

1. Please don't use water that is unhealthy in terms of animalcule or the water that doesn't have a clear quality specification and is not disinfected effectively before or after the operation. The systems that prove to be able to reduce the number of spores can be used in the water that includes spores in the filter process.
2. After the installment of the green canister, the ice produced in the first 24 hours is go rid of.
3. If the taking-out distributor of the refrigerator or the ice-making machine is not frequently used for a long time, or the ice-cold has a terrible smell, the water filter should be changed.
4. The air in the system may cause the water and filter canister to sprinkle water. When moving them out, please be careful.

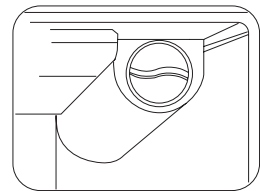
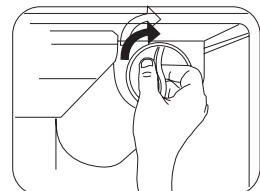
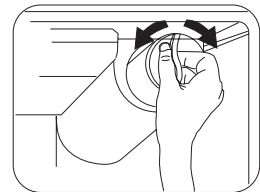
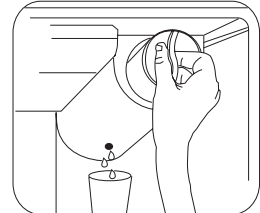
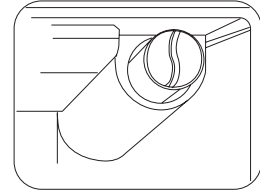
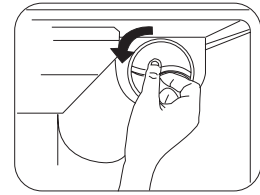

Shutting off the Refrigerator

• Solution when the power is cut off.

If the power is cut off even in summer, within a few hours, the foods can be stored without any problem. If the power is cut off, please call the electricity company and consult about how long the power will be cut off.

- If the power is cut off, don't put new food into the refrigerator, and you should do your best not to open the door of the refrigerator.
- If you know that the power will be cut off, and the time will last more than 24 hours, you should make more ice-colds and hold them well with a container not leaking water, and put the container on the inside of the deepfreeze.

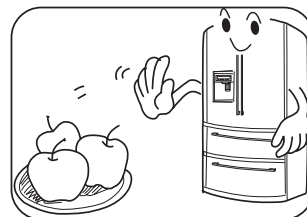

Note

If the temperature inside the deepfreeze fridge returns because the power is cut off or because of other exceptions, the storing time of the food will be reduced and the quality of the food will be lowered.

• Stop using

If the refrigerator needs to stop operation for a long time, the electric plug should be pulled out, and the power and the water should be cut off, and you should clean the refrigerator as specified previously.

If the refrigerator stops operating, the door of the refrigerator should be opened, in case the slight food leavings in the refrigerator may have a terrible smell.

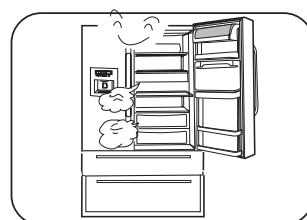

Note

Normally, don't stop using the refrigerator, in case the life of the refrigerator may be affected.

• When you are out on holiday

If you are out on holiday for a long time, please cut off the power and turn off the water tap, take out the food, clean the inside of the refrigerator after the frost in the refrigerator has been unfreeze, dry it and open the door of the refrigerator, in case the slight food leavings in the refrigerator may have a terrible smell. If the ambient temperature is lower than the deepfreeze refrigeration temperature, then you should let qualified servicing person drainage out the water in the water supply system, in case the water pipe or the connecting end may break and a water leakage may be caused, which may result in a serious property loss.

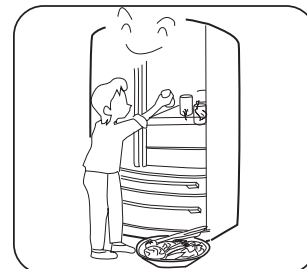

• When the refrigerator is carried.

- Pull out the electric plug, cut off the power.
- Take out all the foods in the refrigerator.
- Using glue, fix the rack of the deepfreeze, the fruits and vegetables box and the rack of the deepfreeze fridge and the other parts of the refrigerator.
- Close the door of the refrigerator firmly; fix the door with glue, in case it may be opened when being moved.
- When carrying the refrigerator, the biggest slant angle should not be more than 45 degrees (the angle between the refrigerator and the vertical direction), in case the refrigerant system may have exception, which will affect the normal operation of the refrigerator.
- When moving the refrigerator, please don't move it by holding its handle, in case a property loss or life injury may be caused.

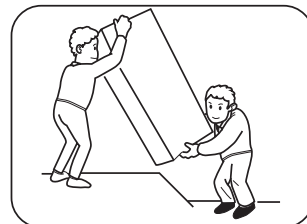

Note

Never let the refrigerator be placed levelly.

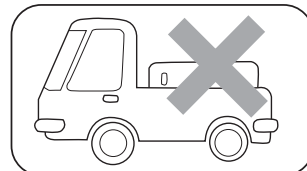

Trouble Shooting

Before you call for service, please first read the following table. And this will save your time, and also save your money. In this table, the normal problems are included except for the crafts shorting or the problems caused by the refrigerator itself.

problem	cause	solution
The temperature is too low.		
The compressor doesn't work.	<ul style="list-style-type: none"> • The refrigerator is in deepfreeze refrigeration circulation. • The refrigerator isn't powered on. • The fuse or the breaker of the room brake out. • There is no line electricity. 	<ul style="list-style-type: none"> • This case is normal for a refrigerator that can do deepfreeze refrigeration automatically. The period of deepfreeze refrigeration lasts about 30minutes. • Make sure that the electric plug is cut into the socket closely. • Check and change the hang-fuse of 15amp. Reset the breaker. • Check the power line in the room. Call the local electricity company.
The refrigerator operates frequently or operates for a long time.	<ul style="list-style-type: none"> • The room temperature or the outside temperature is too high. • The refrigerator is powered off recently for a period of time. • The automatic ice-making machine is operating. • The door of the refrigerator is too often opened and closed or it is opened for too long a time. • The chill-cold storage or deepfreeze fridge is operating with their doors left unlocked. • The set and controlling temperature in the deepfreeze fridge is too low. • The seal on the chill-cold storage or deepfreeze refrigeration door is dirty, frayed, cracked, or isn't equipped well. • The condenser is dirty. 	<ul style="list-style-type: none"> • On this condition, it is normal for the refrigerator operates for a long time. • Normally, 8-12 hours are needed to let the refrigerator refrigerate completely. • The process of ice-making makes the refrigerator operate for a slight too long time. • The warm air entering the refrigerator causes the refrigerator to oscillate frequently. So don't open the door frequently. • Make sure that the refrigerator is level. The foods and container cannot block the door. See the opening/ closing/ drawer Part in Part Problem. • Set the temperature a little higher till the satisfied temperature inside the refrigerator is achieved. The temperature inside the refrigerator can only achieve a balance after 24 hours' operation. • Clean or change the door seal. The leakage on the door seal may cause the refrigerator to operate too long to maintain needed temperature. • Clean the condenser.
The compressor is started and stopped frequently.	The temperature sensor makes the refrigerator can keep a balanced temperature.	This is normal. The refrigerator is started and stopped to make sure the temperature is in a balance.
The temperature is too low.		
The temperature inside the deepfreeze fridge is too low, and the temperature inside the chill-cold storage can achieve a default value.	The temperature inside the deepfreeze fridge is set to be too low.	Set the temperature inside the deepfreeze fridge a little higher. The temperature can achieve a balance only after 24 hours.
The temperature inside the chill-cold storage is too low, and the temperature inside the deepfreeze fridge can achieve a default value.	The temperature inside the chill-cold storage is set to be too low.	Set the temperature inside the chill-cold storage a little higher. The temperature can achieve a balance only after 24 hours.

Trouble Shooting

problem	cause	solution
The temperature is too low.		
The foods stored in the drawer is frozen	<ul style="list-style-type: none"> The set controlling temperature inside the refrigerator is too low. 	<ul style="list-style-type: none"> Set controlling temperature inside the refrigerator to be a little high. The temperature can achieve a balance only after 24 hours.
The foods stored in the meat-stored box is frozen	<ul style="list-style-type: none"> The set controlling temperature inside the meat-storing box is too low. 	<ul style="list-style-type: none"> Adjust the controlling temperature inside the meat-stored box.(Meat should be stored in a temperature that is only a little lower than that on the deepfreeze refrigeration point to assure the longest freshness-remaining time. The form of ice due to the humidity of wetness of the meat is normal.
Number on the temperature vision board is sprinkling.	<ul style="list-style-type: none"> An operation problem is monitored by the automatic controlling system. 	<ul style="list-style-type: none"> Call the Haier service person that can understand the information or codes on the temperature vision board that is sprinkling.
The temperature is too high.		
Deepfreeze fridge / chill-cold storage set controlling temperature is too high.	<ul style="list-style-type: none"> The door is opened too frequently or for a too long time. The door is left unlocked. he condenser is dirty. 	<ul style="list-style-type: none"> When opening the door, the warm air will enter the refrigerator. So open the door of the refrigerator as few as possible. See "opening/ closing door/drawer "of Problem Part. Clean the condenser.
The temperature inside the deepfreeze fridge is too high, and the temperature inside the chill-cold storage can achieve a default value.	<ul style="list-style-type: none"> The temperature inside the deepfreeze fridge is set to be too high. 	<ul style="list-style-type: none"> Set the temperature inside the deepfreeze fridge a little lower. The temperature can achieve a balance only after 24 hours.
The temperature inside the chill-cold storage is too high, and the temperature inside the deepfreeze fridge can achieve a default value.	<ul style="list-style-type: none"> The temperature inside the chill-cold storage is set to be too high. 	<ul style="list-style-type: none"> Set the temperature inside the chill-cold storage a little lower. The temperature can achieve a balance only after 24 hours.
The temperature inside the meat-stored box is too high(some models).	<ul style="list-style-type: none"> The set controlling temperature inside the meat-stored box is set too high 	<ul style="list-style-type: none"> Adjust the temperature inside the meat-stored box, and set a low one.
Water/ humid/ frost in the refrigerator.		
Wet air gets together on the inside of the refrigerator	<ul style="list-style-type: none"> It is hot and wet. The door of the refrigerator is left unlocked. The door of the refrigerator is opened too frequently and is opened for too long a time. Open the container. 	<ul style="list-style-type: none"> The conglomeration of the frost and the inside water drops increase quickly. See See the opening/ closing/ drawer Part in Part Problem. Don't open the door too frequently. Cover the container.
Water conglomeration at the bottom side of the drawer cover	<ul style="list-style-type: none"> Loose the vegetables, release the wet air. 	<ul style="list-style-type: none"> It is normal for the wet air to exist at the bottom side of the drawer cover Move the wetness controller, and set the value low.

Trouble Shooting

problem	cause	solution
Water/ humid/ frost in the refrigerator.		
Water conglomeration at the bottom side of the drawer cover	<ul style="list-style-type: none"> Water left by the vegetables and fruits once washed in the drawer 	<ul style="list-style-type: none"> When putting the foods into the refrigerator, clean the water first, and it is normal for some water exist at the bottom of the drawer.
Water/ humid/ frost on the outside surface of the refrigerator.		
Wet air conglomeration on the outside surface of the refrigerator or between the two doors.	<ul style="list-style-type: none"> It is wet. The door of the refrigerator is left unlocked, which causes the meeting of the cold air in the refrigerator and the hot air outside the refrigerator. 	<ul style="list-style-type: none"> When it is wet, this case is normal. When the humidity reduces, the wet air will follow it. See the opening/ closing/ drawer Part in Part Problem.
Automatic ice-maker		
The ice-maker doesn't make ice any more.	<ul style="list-style-type: none"> The ice-measuring pole is "on" or at off position. The water supply valve isn't opened. And the deepfreeze fridge isn't cold enough. The saddle-backed valve on the cold water pipe is blocked or is blocked by the other things. Check if the water distributor can distribute water into a balance. 	<ul style="list-style-type: none"> Adjust the ice-measuring pole, make it be "on" or at off position. Turn on the water supply valve. See the opening/ closing/ drawer Part in Part Problem. Turn off the water supply valve. Move the valve away. Make sure that the valve is not a self-inventing saddle-backed valve. Clean valve. Change the valve if needed. If the valve is not saddle-backed valve, ice and water filter will be blocked by the other things, and then the valve must be changed.
The ice-making capacity of the ice-maker is not enough.	<ul style="list-style-type: none"> The ice-making capacity of the ice-maker is less than what you expected. The deepfreeze fridge is not cold enough. The water supply valve is not opened completely. Check if the water distributor is working at a speed that is lower than that of normal case. 	<ul style="list-style-type: none"> The ice-maker can produce about 4-5 ice-colds every 24 hours. The extra ice can produce at most 6 pounds of ice capacity. See "The temperature is too high" part in the Problem Part. Turn off the water supply pipe routine valve. <p>If it is, change the ice and the water filter.</p>
The ice-maker cannot stop producing ice.	<ul style="list-style-type: none"> The ice-measuring pole of the ice-maker is made at the "down" position. 	<ul style="list-style-type: none"> Move that away, release the ice-measuring pole. Move all the ice-colds frozen on the ice-measuring pole.
The ice has a terrible smell.	<ul style="list-style-type: none"> The smell of the chill-cold stogie or the deepfreeze fridge can mix together. The water connected to the ice-maker has smell. The ice is not used frequently. 	<ul style="list-style-type: none"> Cover the foods closely. Throw away the long time ice. The ice-maker produces new ice. Increase the filter on the water supply pipe routine. Consult a water purification company. Throw away the long time ice.

Trouble Shooting

problem	cause	solution
Cold drinks taking-out from outside.		
Cold drinks taking-out from outside	<ul style="list-style-type: none"> • The water supply pipe is not opened. • The water filter is blocked. • If there is a former filter, the former filter is not installed well completely. 	<ul style="list-style-type: none"> • Open the water supply pipe. See “the ice-maker doesn’t make ice” in the Problem Part. • Chang the water filter. • Push the filter in, till a “bada.” .The handle of the filter should be at a level position.
The water has a strange smell.	<ul style="list-style-type: none"> • The water is stored in the container for a period of time. • The water container is not connected to the cold water pipe correctly. • The household water supply pipe routine and its installment may affect the smell of the water. • The mineral capacity in the water is high. 	<ul style="list-style-type: none"> • Take out 10-12 glasses of water and throw them away, to refine the water supplying and clean the container. • Connect the pipe routine to the pipe routine that provides water for the water tap in the kitchen. • Better use copper pipe to do water supplying connecting. • Connect the water dealing factory for help.
The water pressure is too low.	<ul style="list-style-type: none"> • Stopping and starting pressures are too low(only for well system) The counter- saturation system is returning. 	<ul style="list-style-type: none"> • Let people circle up the stopping and starting pressure of the pump system (only for well system) The water pressure is under 30psi when the counter- saturation system is returning.
The refrigerator has a terrible smell.		
The inside of the refrigerator is dirty.	<ul style="list-style-type: none"> • The inside of the refrigerator needs cleaning. • Inside the refrigerator is the food that is strongly smelly. 	<ul style="list-style-type: none"> • Clean the inside of the refrigerator. • Wrap the foods closely.
Open/close the door and the drawer		
The door is not able to be closed.	<ul style="list-style-type: none"> • The door is closed too hard, which causes the other doors open slightly. • The refrigerator is not placed levelly. If the refrigerator is moved slightly, it will shake on the floor. • The refrigerator touches the wall or the cupboard. 	<ul style="list-style-type: none"> • Close the door slightly. • Assure the levelness of the floor, so that the floor can support the refrigerator. Then see “position environment” part. • Assure the levelness of the floor, so that the floor can support the refrigerator. Send for a craftsman to repair the nor level positions.
The drawer is hard to be moved.	<ul style="list-style-type: none"> • The foods touch the shelf over the drawer. • The slide routine of the drawer is dirty. 	<ul style="list-style-type: none"> • Put less food in the drawer. • Clean the drawer and its slide routine.
The lamp is out		
The lamp is out	<ul style="list-style-type: none"> • The lamp is damaged. • The switch of the lamp is blocked. • The refrigerator is powered off. 	<ul style="list-style-type: none"> • See “about deepfreeze/ deepfreeze fridge/ temperature-changing room chapters. • The switch of the lamp is in the side of the deepfreeze, deepfreeze fridge and the temperature-changing room. • See “make the refrigerator operate” of the “exceptions handling”
If you hear:		
beep	<ul style="list-style-type: none"> • One door of the refrigerator is open. 	<ul style="list-style-type: none"> • These beep sounds may repeat every 1 minute, till the door is closed. This is normal for the “half-door opening” alarming.

Limited Warranty

Content and Date of the Guarantee

This guarantee includes all the problems on the craft and material during a period of time: labor of 12 months, the spare parts in 12 months, and the closing system in 5 years.

This guarantee is valid from the day of buying the refrigerator, and before the refrigerator is repaired, the buying receipt must be shown to the specified customer satisfaction center.

Exception: the guarantee for commercial use or renting.

Labor of 90 days

Spare parts in 90 days

No other guarantees

Include:

1. Functional machine or electric parts, the guarantee period is 12 months. Except for the worn part and the side part, all parts of the refrigerator are included.
2. The parts of sealing section. Like: closed compressor, condenser and evaporator. The problems appearing during the five years from the day of buying should be solved. The repair of the damage due to the abuse of the machine or not proper use or the damage caused by moving the refrigerator, are not considered into condition.

How to handle

1. Within the guarantee period, any problem on the machine or the electric parts appearing during normal use of the refrigerator will be taken into consideration according to our judgment.
2. Within the first 12 months, we will not ask for any pay for the repair of the parts within the guarantee range or any pay for the labor from the buyer. If the guarantee date is over, only spare parts are within the range of guaranteeing to keep the refrigerator in good repair. The labor is no longer free, and the paid must be paid by the consumer.
3. Please connect with the nearest specified customers satisfaction center. Please call 1-877-377-3639 to search the nearest specified customers satisfaction center.

This guarantee applies for the refrigerators in the most of American, Porto Rico and Canada. Not include:

The damage caused by not correct installment.

The damage caused during the shipping process.

The problems not caused by production.

The damage caused by abuse of the refrigerator, the wrong use of the refrigerator, accidents, shortage of correct operation or not proper current or pressure.

The damage not caused by the household use.

The damage caused by the selling or serving center not specified.

Decorating sides or the changeable lights

The damage caused during the moving or shipping processes.

Labor (after the first 12 months)

This limited liability guarantee takes place of the any guarantee, including specification guarantee for special purposes.

The compensating measures provided in this limited liability guarantee are only for this refrigerator, and is used to take place of other all measures.

This limited liability guarantee does not take accidents or the caused damage into consideration, so the above restriction may not suitable for your case. In some states, the guarantee date is not allowed to exist, so the above restriction may not suitable for your case.

This limited liability guarantee provides you with specific rights, but your rights may be different due to the difference between states.

Haier in American
New York, NY 10018