

# Haier

Inspired living

## Refrigerator/Freezer Combo

### User's Guide

**HRF-663BSS**

**HRF-663ATA2\***

**HRF-663ASA2\***

**HRF-663ITA2\***

**HRF-663ISA2\***

**HRF-663ASB2\***

**HRF-663ISB2\***

**HRF-661TSAA**

**HRF-661RSSAA**

**HSBS562IS**

**\*=blank, WW, HS, SS, TS**

Thank you very much for choosing to purchase a Haier-brand refrigerator. This User's Guide will help you properly install and operate your newly acquired appliance.

For future reference, please write down the model and serial number in the spaces provided below.

You can retrieve that information from the product label attached to the inside of the refrigerator.

Model number:

Serial number:

Date of purchase:

# Contents

## Before operation

Your refrigerator's features.....	1
Components.....	2
Precautions.....	3-5
Preparations.....	6-9
Door removal.....	10-11
Setting up the Refrigerator/Freezer Combo.....	12
Start-up.....	13
Digital display operation.....	14-16

## Notes on the refrigerator compartment

Refrigerator compartment.....	17-19
Notes on refrigeration.....	20
Tips on refrigeration.....	21
Home bar.....	22-23

## Notes on the freezer compartment

Freezer compartment.....	24
Notes on freezing.....	25
Ice maker and dispenser operation.....	26-27
Removing and installing the ice cube container.....	28
Dispenser operation.....	29
Dispenser precautions.....	30

## Defrosting Cleaning Inoperation

Defrosting.....	31
Cleaning.....	31
Inoperation.....	32-33

## Troubleshooting & Customer Service

Troubleshooting.....	34-35
Customer service.....	36-38

- Before start-up, be sure to read the User's Guide.
- Keep the User's Guide in a safe place.



## Your refrigerator's features

**Your Haier-brand Refrigerator/Freezer Combo is equipped with numerous innovative, space-saving and energy-efficient features.**

- (1) Ice cube maker  
Automatic ice cube maker, powerful ice crusher, refrigerated water dispenser
- (2) Minibar (HRF-663BSS,HRF-663ATA2\*,HRF-663ASA2\*,HRF-663ASB2\*)  
You can store drinks here for quick retrieval without having to open the refrigerator door.
- (3) Sliding glass shelves  
Sliding shelves and baskets in the refrigerator and freezer compartments make storing foods easy. With the doors fully opened, all shelves can furthermore be removed for convenient cleaning.
- (4) Slim profile with spacious interior  
This Refrigerator/Freezer Combo was developed according to our customers' wishes. Thanks to the latest space-saving insulating materials, the freezer and refrigerator compartments now offer even more space. The shelves and baskets are made of high-grade safety glass.
- (5) The freezer compartment is equipped with a user-friendly frost-free system and manages to freeze foods quickly and evenly.
- (6) Temperature adjustment before defrosting
- (7) Automatic trouble indicator
- (8) This Refrigerator/Freezer Combo is equipped with a condenser, and the cold air is circulated by a fan in order to achieve optimum cooling.
- (9) Buzzer warning when door is open  
A buzzer sounds intermittently when the door is left open permanently or is not closed properly.
- (10) Intelligent mode  
Optimum cooling is automatically adjusted in relation to the interior and surrounding temperatures.

# Components

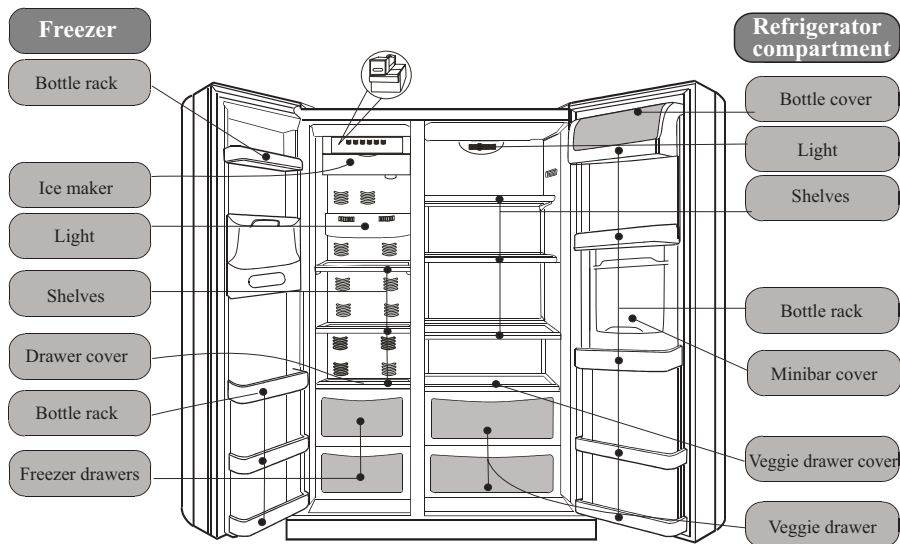

## Note

- The power plug must remain accessible after setting up the appliance.  
If the supply cord is damaged, it must be replaced by the manufacturer, its service agent or similarly qualified persons in order to avoid a hazard.
- Check the appliance for damages sustained during transportation. Do not connect the appliance if it is damaged. In case of damage, contact your supplier.
- Make sure that no part of the refrigerant circuit is damaged when transporting and setting up the appliance.  
Should the refrigerant circuit have been damaged, keep away all sources of fire or sparks and thoroughly air the room.
- This appliance is not intended for use by persons (including children) with reduced physical, sensory or mental capabilities, or lack of experience and knowledge, unless they have been given supervision or instruction concerning use of the appliance by a person responsible for their safety.
- Children should be supervised to ensure that they do not play with the appliance.
- To prevent damage to the appliance, its ventilation openings must not be covered or blocked.
- Do not use any mechanical or artificial devices or any tools other than those recommended by the maker in order to accelerate the defrosting process.
- Do not operate any electrical devices inside the food storage area, unless instructed to do so by the maker.

Our company continually thrives towards improving all models and versions. For that reason, we hope that you can accept our right to change their appearance, equipment or operation.

# Precautions

This appliance requires a 220-240V/50Hz power supply.

If the voltage is outside of the 187-242V range, malfunctions and damages of the controls, thermostat or compressor may result, unless a regulator of at least 750W was installed.

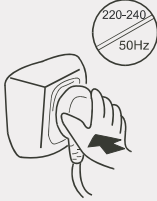

A dedicated grounded outlet is required. The appliance is equipped with a standard shockproof plug, whose grounding should not be disabled. The power plug of the appliance should always be accessible.



Do not damage the power cord.

\*Never pull the plug out by the cord; always grab and pull the plug

\*Do not place the power cord under the appliance or walk on it.

\*Be sure not to damage the power cord when moving the appliance away from the wall.

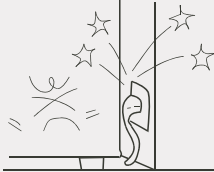

If the power cord is damaged or the plug cracked or worn, the power cord must be replaced with a matching one, available from the maker or their customer service. The power cord may only be replaced by the maker, their customer service or an equally qualified person.



In the case of a gas or other flammable leak:

\*Close the valve.

\*Open the doors and windows.

\*Do not pull out or insert the power cord of the appliance.



Pull out the power plug:

\*Before cleaning or repair

\*When replacing a burned-out bulb

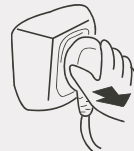

# Precautions

Never place flammable, explosive or corrosive materials in the refrigerator.



This appliance is intended strictly for storing and freezing foods. It is not suitable for storing such things as vaccines, bacteria or chemical samples, which have demanding temperature requirements.

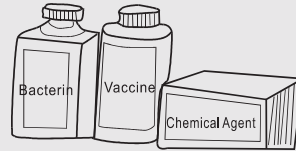

Do not store fuel and other flammable products near this appliance.

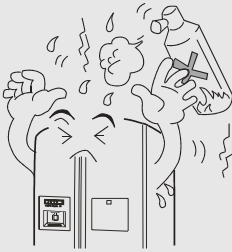

Do not put microwave ovens, voltage regulators or power strips on this appliance. Do not operate electrical devices and such inside the refrigerator (except if instructed to do so by the maker).



To avoid injuries, do not let children climb on or hang from the appliance door.



Once the appliance has been started up, do not touch the inside of the freezer compartment with wet hands, otherwise they may get stuck on the surface.



# Precautions

To avoid injury, keep fingers away from the door crack when opening or closing the doors. Keep children away from the appliance doors being opened and closed.



Do not pour water onto the appliance or set it up in wet areas.



Refrigerators may only be repaired or altered by professionals. Improper repair may cause considerable damage. Please contact your dealer or our customer service should your appliance require repair or modification.



Keep bottles and tins out of the freezer. They could burst when the content freezes.



Pull out the power plug in the case of a power outage, repair or cleaning.

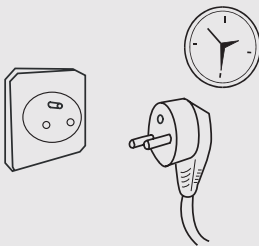

When disposing of the appliance, remove the door or door seal and shelves to prevent playing children from locking themselves in and putting their lives at risk.

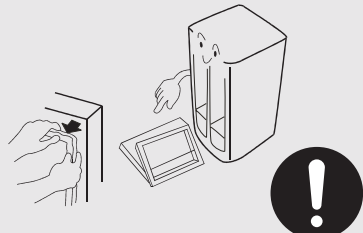

# Preparations

1

## Unpacking

Remove the entire packing material, including the foam underlay and pieces of tape used to hold accessories in place.

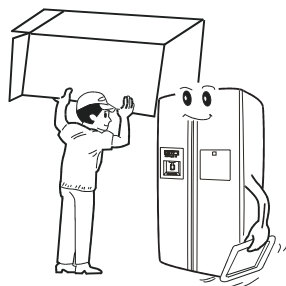

2

## Separate and count the included accessories.

Check the items in the box against the packing list. In case of a mismatch, please contact your supplier.



3

## Set up the appliance in a suitable area.

(Details under “Setting up”.)

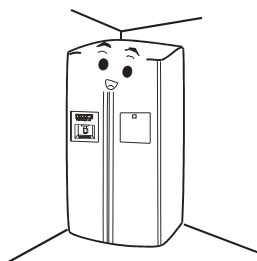

4

## Attaching the toe moulding

Open the refrigerator and freezer doors, remove the moulding from the refrigerator compartment, and then affix it as shown in the illustration.



## Preparations

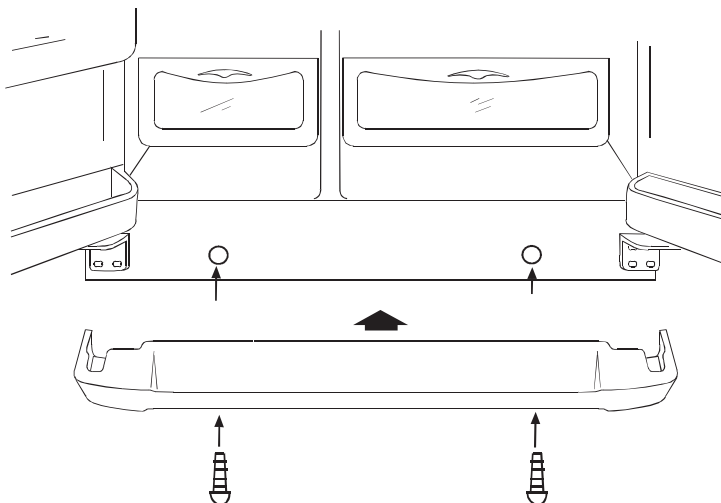

5

### Installing the door handle

First, screw part 2 into the threaded hole in the door (part 1); there are two screws per door. Next, press part 3 with its larger opening onto part 2. Finally, pull part 3 down in order to attach it firmly to the door.

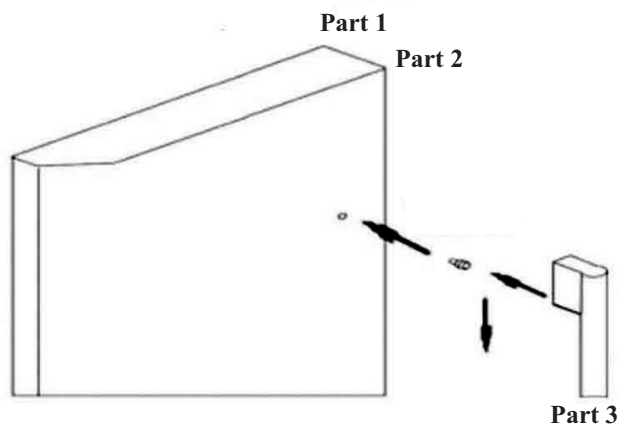

# Preparations

## Assembly of the Door Handle

Please following the below operations when you are assembling the Door Handle:

- 1)Put the Handle Connector into the right holes on the Refrigerator Door with the help of screwdriver.(as showing by the arrow 1 of illustration 1)
- 2)Put the Refrigerator Door Handle onto the handle holder,and keep the hole of the handle holder and the handle connector to the right position of the vertical direction. (as showing by the arrow 2 of illustration 2)
- 3)Insert the Connecting Bolt of the Handle into the two holes of the Handle Holder with the help of Six angle Screwdriver.(as showing by the arrow 1 of illustration 2)
- 4)Fix the cover of top bolts to the right position. (as showing by the arrow 2 of illustration 2)
- 5)When you are disassembling the Refrigerator door handle,please operate as the opposite way of assembling.

### Attention:

Please do not disassemble the door handle. Any modifications must be done by a qualified technician.

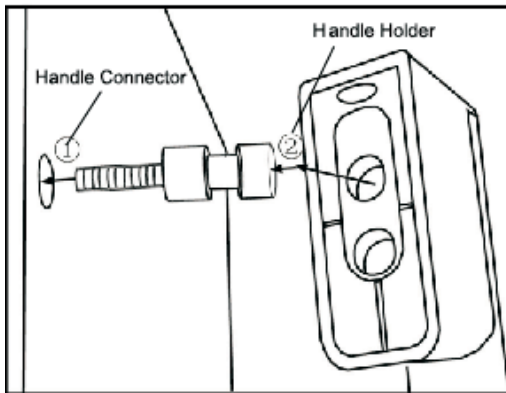

illustration 1

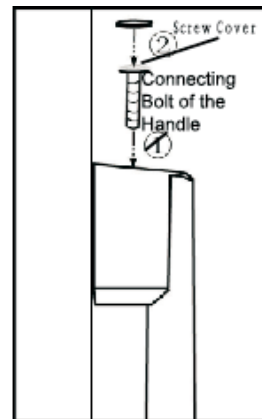
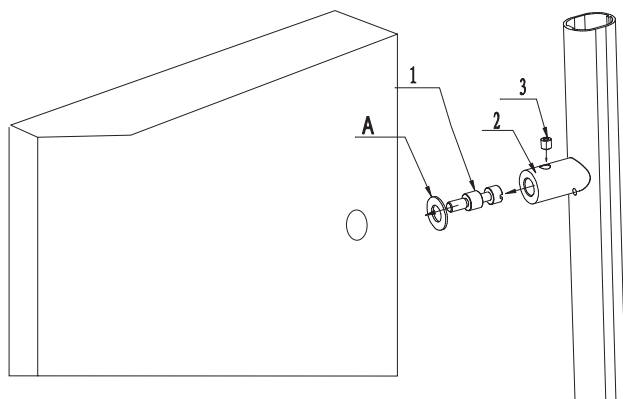

illustration 2

### Note:

If you choose the models(HRF-661RSSAA,HRF-661TSAA),Please install handles as below.

## Preparations



6

It is recommended to clean the interior before starting up the appliance. (Details under “Cleaning”.)

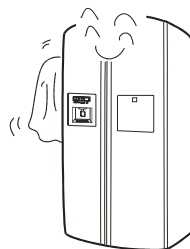

7

### Standstill

After cleaning, let the appliance stand still for at least six hours before turning it on to start it up.

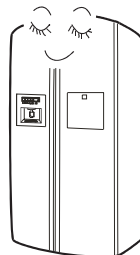

# Door removal

## Removing the door

If your house door is too narrow, remove the refrigerator door and carry the refrigerator in narrow side first.

### 1 Remove the toe moulding, and then release the water coupler.

Slide the toe moulding up to remove it, and then release the water coupler while pressing on area (1) as shown in the illustration.

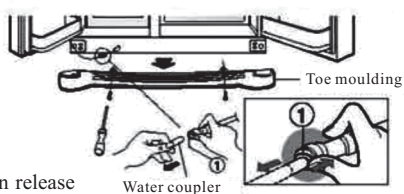

### 2 Remove the freezer compartment door.

1) Unscrew the hinge covers. Disconnect all wires except for the grounding wire.

2) Remove the screws from the upper hinge following the direction as indicated by Arrow (1). Then remove the upper hinge following the direction as indicated by Arrow (2).

3) Lift the freezer compartment door to remove it. Next, lift the door enough to be able fully pull out the water line.

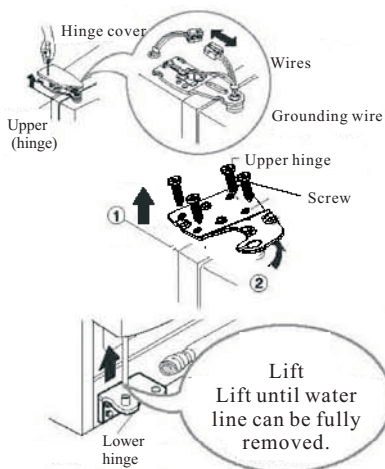

## Door removal

**3** Remove the refrigerator compartment door.

1) Loosen the hinge cover bolts, and then remove the cover. Disconnect any wires except for the grounding wire.

2) Remove the screws from the upper hinge following the direction as indicated by Arrow (1). Then remove the upper hinge following the direction as indicated by Arrow (2).

3) Lift the refrigerator compartment door to remove it.

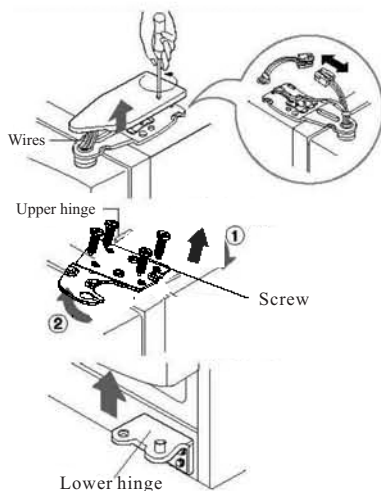

**4** Slide the refrigerator through the door opening.

Slide the refrigerator through the door opening as shown in the illustration.

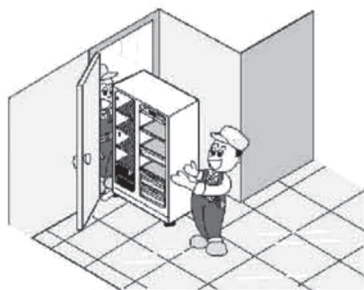

**5** Reinstall the door.

Bring the doors in the house, and then reinstall them by reversing the removal steps.

# Setting up the Refrigerator/Freezer Combo

Be sure to choose a flat and level setup location. Use sturdy and fireproof supports to correct an unevenness in the floor. Turning an appliance foot clockwise raises the appliance, turning it anticlockwise lowers the appliance.

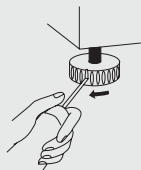

Protect the setup location against direct sunlight or heat sources.

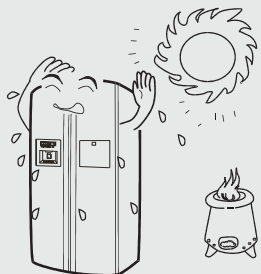

Avoid a damp setup location. Remove water and dirt with a soft rag.

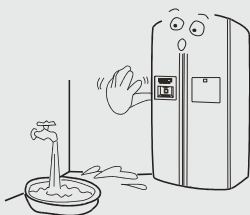

## Door adjustment

If the freezer compartment door is lower than that of the refrigerator compartment, insert the wrench in the groove of the left screw and turn it in the direction of the arrow until both doors are the same height.

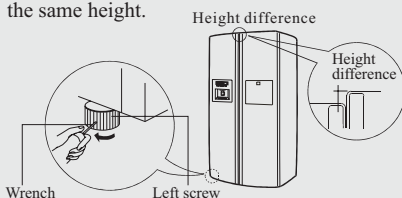

If the freezer compartment door is lower than that of the refrigerator compartment, insert the wrench in the groove of the left screw and turn it in the direction of the arrow until both doors are the same height.

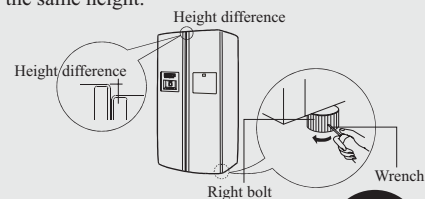

Be sure to leave at least 10 cm of space around the appliance. When installing the appliance in an enclosed area, leave at least 25 cm of space on the sides and 5 cm on the top and back.

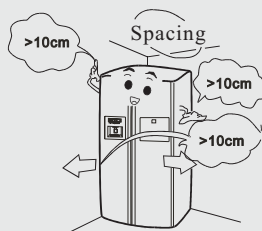



## Start-up

1

### Power connection

After connecting it to the power, the appliance is automatically set to the Intelligent and Crushed Ice modes.

This appliance has a memory function which, in the event of a power failure, automatically stores the operating mode that was last used and restores it when the power is turned on again.

2

### Operating modes

#### Recommendation:

The Intelligent mode allows the appliance to achieve optimal cooling temperatures, regardless of ambient temperature variations.

Choose one of the following two operating modes.

(1) Intelligent mode: If there are no special requirements, it is recommended to choose the Intelligent operating mode. Press the Intelligent key once; the indicator lights up and the appliance is started automatically. (Details in the “Features” section.)

(2) Manual mode: Make manual temperature settings using the temperature adjustment keys.

3

### Loading foods

Operate the refrigerator empty for a while. Start loading the refrigerator with foods only after it has sufficiently cooled down.



Please note that changes in the temperature settings come into effect slowly.

This depends on variations of the ambient temperature, how frequently the door is opened and the amount of foods loaded.

## Digital display operation

①

### Control panel

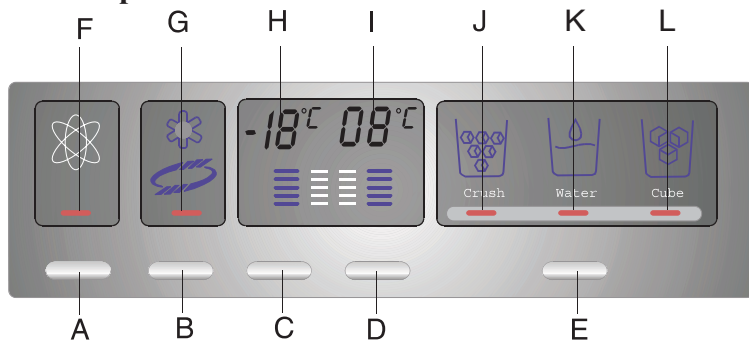

A. Intelligent mode key indicator

B. Superfrost key

C. Freezer temperature adjustment key

D. Refrigerator temperature adjustment key

E. Ice/water selector

F. Intelligent mode indicator

G. Superfrost indicator

H. Freezer temperature display

I. Refrigerator temperature display

J. Crushed ice indicator

K. Refrigerated water

L. Ice cube indicator

②

### Intelligent mode

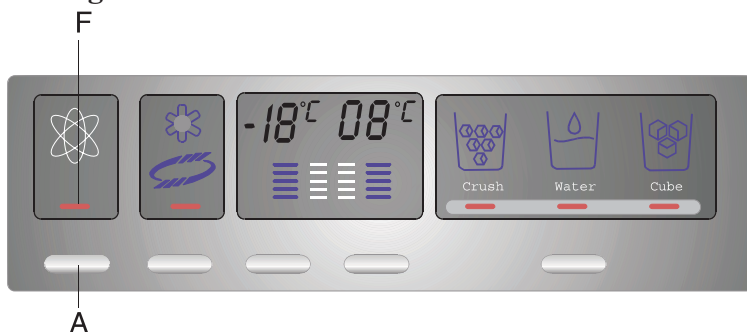

In the Intelligent operating mode, the temperature inside the appliance is adjusted automatically according to variations of the ambient temperature. Press key A once, upon which indicator F lights up and Intelligent mode is entered. Press key A once again, upon which indicator F goes off and Intelligent mode is cancelled.

③

### Malfunction indicator

In the event of major or minor control malfunctions, the freezer and refrigerator temperatures are not displayed. Contact customer support if necessary.



## Using the digital display

### 4 Superfrost

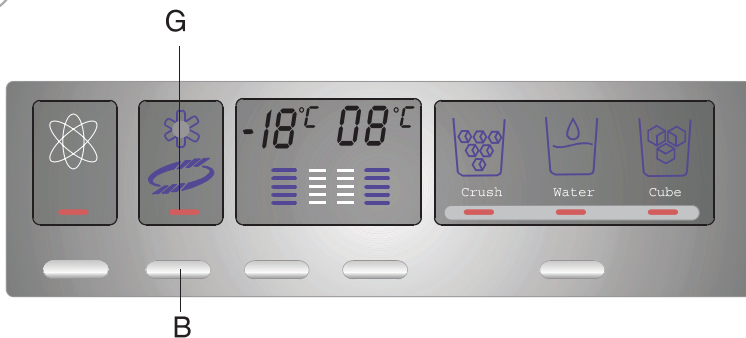

It has been scientifically proven that a Superfrost type device is necessary to freeze foods quickly and thoroughly. Press key B, upon which indicator G lights up and the Superfrost action is turned on. Press the key again to turn off the Superfrost action, upon which indicator G goes off. (In Intelligent mode, it is not necessary to turn on Superfrost.)

### 5 Temperature adjustments

- At start-up, the Intelligent operating mode is selected. Press the Intelligent mode key to cancel the Intelligent operating mode.
- Temperature adjustment (requires the Intelligent mode to be cancelled)

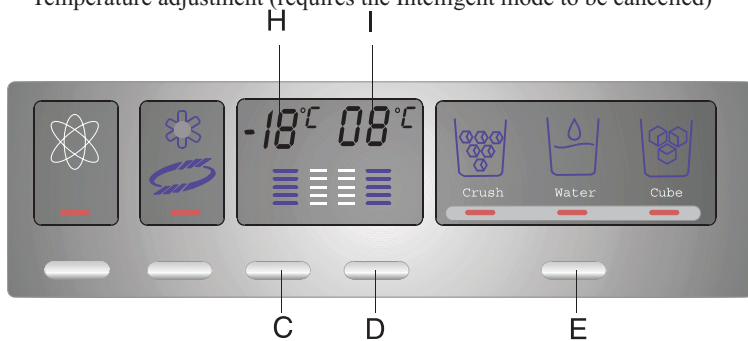

Refrigerator temperature adjustment: Press key D, upon which indicator I starts blinking. Each time key D is pressed, the temperature setting is increased by one of level from 1 to 5 (3 °C). If you keep pressing key D, the cycle starts over again from level 1 (7°C).

Freezer temperature adjustment: Press key C, upon which indicator H starts blinking. Each time key C is pressed, the temperature setting is increased by one level from 1 to 5 (-22 °C). If you keep pressing key C, the cycle starts over again from level 1 (-15°C).

Ice/water selection: Press key E.

Help yourself to ice cubes/crushed ice/refrigerated water. Your selection becomes available when the appropriate indicator lights up.

## Using the digital display

6

### Open-door buzzer warning

A buzzer sounds intermittently when the door is left open permanently or is not closed properly.

7

### Display control

30 minutes after the last key operation the display is turned off. The display is re-activated as soon as a key is pressed or an appliance door is opened.

8

### Activating/Deactivating the refrigerator

The refrigerator is deactivated by holding key D (refrigerator temperature adjustment) firmly pressed for three seconds. Indicator I (temperature and level) goes off, but the light in the refrigerator compartment remains operational. The refrigerator is re-activated by holding key D firmly pressed again for three seconds. The refrigerator is re-activated and indicator I is turned on.

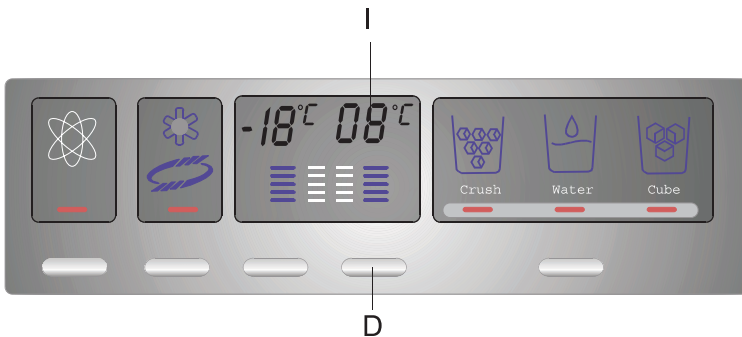

## Refrigerator compartment

### Use the refrigerator compartment for short-term food storage

The average refrigerator temperature of 0 °C-10 °C is not low enough for long-term storage of foods; it is suitable only for short-term food storage.



### Adjusting the height of glass shelves

The shelves are height-adjustable to accommodate various item sizes.

The shelves can be taken out for height adjustment and cleaning. To clean a shelf, pull it in direction 1, and then tilt it in direction 2 until it is in a vertical position. Finally, remove the shelf in direction 3. To remove a shelf, the appliance door must be open 90°.

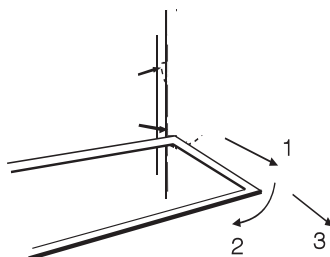

### Adjusting and cleaning bottle rack

Hold both sides of the bottle rack and pull it out in directions (1) and (2).

#### Caution:

Frozen foods (such as ice cream) should not be placed in the bottle rack but rather inside the freezer compartment to avoid that they spoil as a result of being exposed to the temperature changes from opening and closing the door.

After cleaning, re-place the bottle rack or adjust its position.

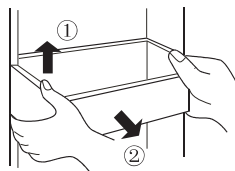

# Refrigerator compartment

## Stocking example

Foods should be grouped according to the various temperature ranges in the refrigerator compartment.

- (1) Eggs, butter, cheese
- (2) Tinned drinks and foods, seasonings
- (3) Drinks, bottles
- (4) Preserves
- (5) Meats
- (6) Flours, preserves, milk
- (7) Processed meats, sausage
- (8) Fruits, vegetables, lettuce

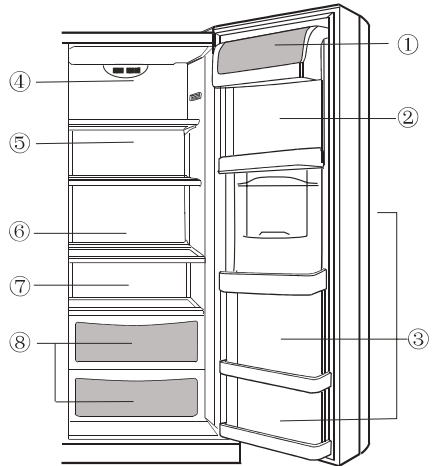

## Removing the veggie drawer cover

First, lift the rear of the shelf in direction (1), and then pull the shelf out in direction (2). Finally, tilt the shelf in direction (3) and remove the veggie drawer once the door is open 90°.

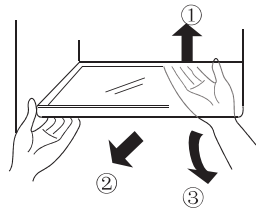

## Refrigerator compartment

### Using the veggie drawer

The appliance is equipped with a veggie drawer suitable for keeping fruits and vegetables. The humidity level in the veggie drawer is adjustable.

- Reducing or closing the opening increases the humidity inside the veggie drawer, which is desirable for keeping cucumbers, grapes, kiwi, plums, etc.
- Increasing the opening reduces the humidity inside the veggie drawer, which is suitable for keeping strawberries, mandarins, beans, garlic, water melon, plums, tomatoes, etc.
- Make sure that the front of the veggie drawer cover is located on the inside of the veggie drawer. Remove the veggie drawer before removing its cover.

Installation is reversed.

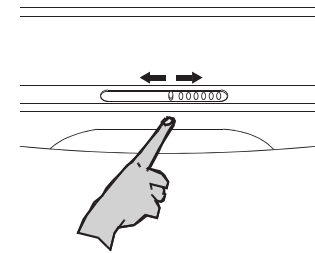
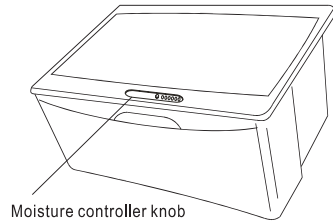

### Replacing the bulb at the top of refrigerator compartment

Bulb specifications: 220-240 V / 25 W

Socket: E27 (Do not use a replacement bulb of more than 25 W.)

Replacing the bulb

- Unplug the power cord.
- Remove the screws under the cover.
- Lift the cover in direction (1), and then pull it out in direction (2).
- Install the bulb.

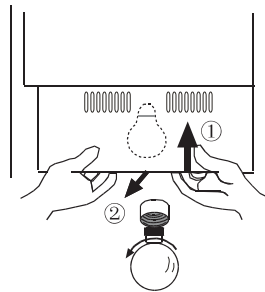

## Notes on refrigeration

Let warm foods and drinks cool down to room temperature before putting them in the refrigerator compartment.

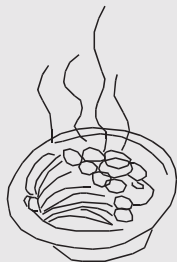

Wash and dry off fresh foods before storing them.



Pack and seal foods before storing them. This prevents drying and odour dissipation.



Pack the food into portions suitable for your household. Place the foods that will be consumed the soonest towards the front so as not to leave the appliance door open longer than necessary.



Do not overstock the refrigerator.

Be sure to leave space between foods and between the foods and the interior compartment walls.

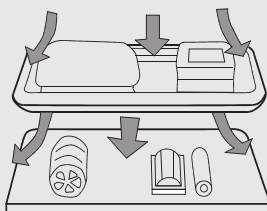

## Tips on refrigeration

Remove the leaves of root vegetables to prevent them from absorbing the nutrients.

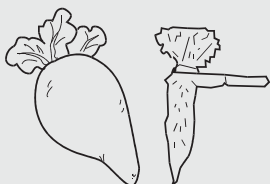

Thawing frozen foods inside the refrigerator helps conserve energy.



Items not requiring refrigeration: Onions, peppers, garlic, ginger.

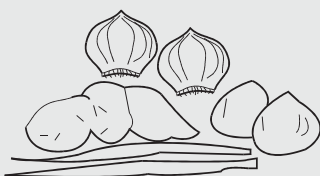

Items not suitable for refrigeration: Gourds, melons, bananas, pineapple. Refrigeration promotes their decomposition. Do not refrigerate unripe fruits.



Caution: Do not use the egg tray as an ice cube tray and never place it in the freezer or Superfrost area to prevent it from cracking.

## Home bar

1

### Operation

To open the bar, press the compartment button.

The bar compartment opens.

The home bar can be used without opening the appliance door; which saves energy.

When the home bar is opened, the refrigerator light comes on.

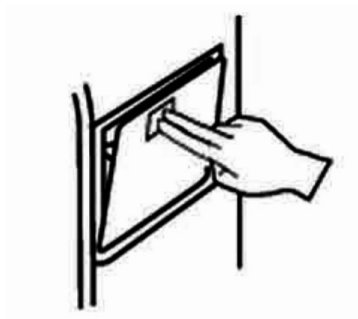

2

You can place drinks and other foods in the home bar.

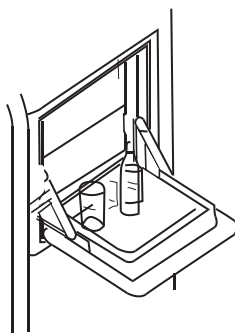



## Home bar

### 3 Do not remove the inner cover of the home bar.

The home bar will not operate if the cover has been removed.

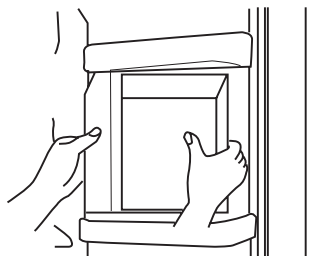

### 4 Keep children away from the home bar. Otherwise children could be injured and the home bar damaged.

**Note:** The home bar can be used without opening the appliance door; which saves energy. Close the home bar as soon as possible to keep the cold inside the appliance. The warning system is activated if the door is not properly closed.

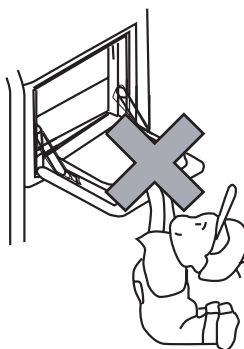

# Freezer compartment

## Use the freezer compartment for long-term food storage

A low temperature in the freezer compartment is necessary for long-term food storage. Do not exceed the maximum length of storage indicated on the package.

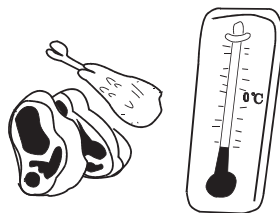

## Removing and cleaning glass shelves

First, lift the rear of the shelf in direction (1), and then pull the shelf out in direction (2). Finally, tilt the shelf in direction (3) and remove it once the door is open 90°.

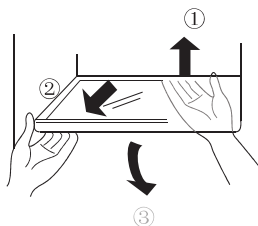

## Interior light and replacement of bulb

Bulb specifications: 220-240 V / 25 W

Socket: E27 (Do not use a replacement bulb of more than 25 W.)

Replacing the bulb

- Pull out the power plug or neutralise the fuse.
- Lift the cover in direction (1), and then pull it out in direction (2).
- Twist the bulb anticlockwise, and then remove it. Install a new bulb of equal specifications.
- Re-install the cover.

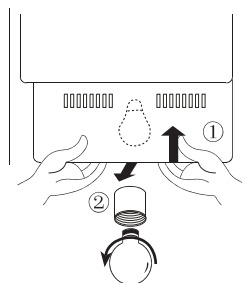

## Adjusting and cleaning bottle rack

Hold both sides of the bottle rack and pull it out in directions (1) and (2). Clean the bottle rack, and then re-place it or adjust its position.

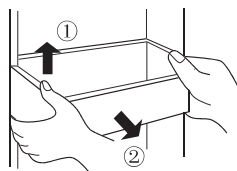

### Caution:

Frozen foods (such as ice cream) should not be placed in the bottle rack but rather inside the freezer compartment to avoid that they spoil as a result of being exposed to the temperature changes from opening and closing the door.

## Notes on freezing

Let warm foods and drinks cool down to room temperature before putting them in the freezer compartment.

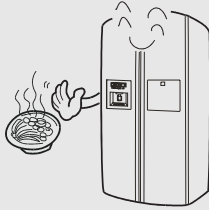

Pack the food into portions of up to 2.5 kg suitable for your household. As a result, the portions will freeze faster and the quality after thawing remain optimal for preparation.

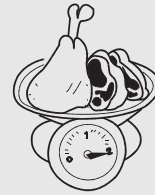

Package the food before freezing it. The packages should be dry to prevent their sticking together. Use only freezer-compatible packing material; this should be strong, taste-neutral, air- and watertight so as to minimize taste contamination and loss of quality.

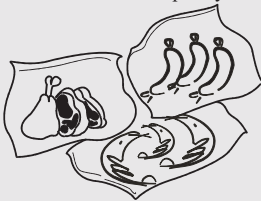

Always write the content and freezing date on the packing, and do not exceed the recommended length of storage so as to prevent loss of quality.

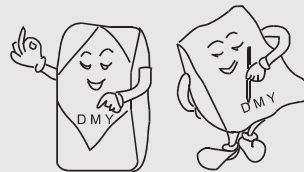

Remove only the required amount to be thawed. Thawed foods must never be frozen again.

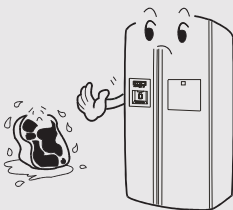

Never place more fresh food in the freezer at one time than the maximum freezing capacity.



# Starting up the ice maker and dispenser

1

## Preparations before starting up the ice maker and dispenser

The ice maker can be connected either directly to a water supply line if fitted with a filter (option A) or to a drinking water container if fitted with a water pump (option B).

- Cut the water line to the right length to prevent it from kinking. The recommended maximum length for the water line is 12 m. The pressure drop resulting from an excessively long water line could adversely affect the ice cube maker capacity.
- Keep the water line away from heat sources.
- The water supply line should be installed and checked by professionals.
- When calling for refrigerated water for the first time, keep pressure on the dispenser lever for one minute several times until water flows out, in order to allow the water tank inside the appliance to fill up. Be sure not to hold the dispenser lever pressed for too long, otherwise the water valve may overheat.

### Option A:

- Water supply line installation  
The pressure of the cold water supplied to the ice maker should be within 1.5-8.5 bar.
- It is recommended to use drinking water for producing ice cubes since the filter does not sterilise bacteria.
- Connect to potable water supply only.

### Option B:

- The water pump must be connected to its own outlet and properly grounded.
- Removal or modification of the water pump and modification or repair of the water supply line by unauthorised persons are not permissible.
- To prevent fire, do not store or use flammable products such as fuel near the water pump.
- The water pump is to be used solely with room temperature water; it is not suitable for use with chemicals, fruit juice or other grainy drinks, coffee or other hot liquids.
- If the water pump will not be used for an extended period of time, pull out its power plug.
- Periodically check the water tank to make sure that the water level is sufficient.
- Do not push, shake or knock the water pump.
- Place the water pump and drinking water container on a sturdy and level surface.
- After opening the small lid of the drinking water container, protect the opening with a dust cover. Guide one end of a hose to the bottom of the container and connect the other end to the water pump inlet (indicated by an INLET symbol). Connect one end of another hose to the water pump outlet (indicated by an OUTLET symbol) and the other end to the water valve inlet under the back of the refrigerator.
- Fill with potable water only.

# Ice maker and dispenser operation

## 2

### Precautions

- Do not connect the ice maker water line when the temperature is below 0 °C, otherwise the water line may freeze
- Open the valve and flush the water line to check the line connections for possible leaks. Close the valve again when the water is clean and clear.
- The ice maker does not become operational until the temperature has reached or gone under -15 °C. (Do not consume the first batch of ice cubes.)
- After setting up the appliance, be sure to check that the water supply line is properly positioned so that it will not be pinched or damaged.
- The ice maker must be installed by an authorized representative.
- The ice maker must be connected to a standard cold water pipe.
- If the water dispenser indicator does not work, contact customer service or a qualified professional for repair.

## 3

### Ice maker operation

Each cycle produces eight ice cubes. The ice cube production capacity depends on variations of the ambient temperature and how frequently the door is opened.



Caution: Let the appliance operate at least 24 hours before starting ice cube production

Do not consume the first ice cubes after starting up the appliance for the first time or following a long period of inoperation.

Arrange the ice cubes manually to make sure that the container has been filled.

A few of the eight ice cubes produced in one ice maker cycle may stick together.

## Removing and installing the ice cube container

### Removing the ice cube container

Press the middle section of the ice cube container in and pull it off its shelf.

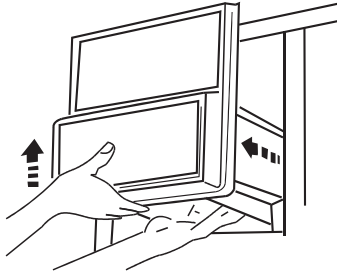

### Re-placing the ice cube container

Slide the ice cube container in the channel on both sides of the inner sleeve until it is clasped into position.

If the ice cube container cannot be fit into position, take it out again, rotate the support by 90°, and then re-insert the container so that the clamp locks with the channel.

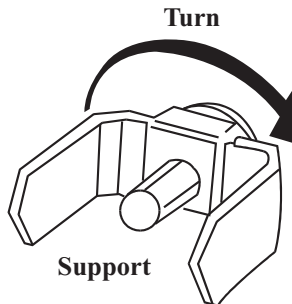

# Dispenser operation

## Dispenser operation

Choose crushed ice, refrigerated water or ice cubes. Slightly push a glass against the ice/water lever as shown in the illustration.

### (1) Dispensing crushed ice

- Press the appropriate button so that the indicator for crushed ice lights up.
- Lightly press against the lever so that crushed ice is supplied.



### (2) Dispensing ice cubes

- Press the appropriate button so that the indicator for ice cubes lights up.
- Lightly press against the lever so that ice cubes are supplied.



### (3) Dispensing refrigerated water

- Press the appropriate button so that the indicator for refrigerated water lights up.
- Lightly press against the lever so that refrigerated water is supplied.

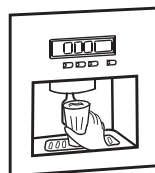

### Dispensing crushed ice

- Even with the ice cube option selected, some crushed ice may be supplied simultaneously. It is also possible that the crushed ice supply is mingled with a few ice cubes.
- When crushed ice is frequently called for, it is normal for frost to build up around the outlet, but it will eventually evaporate.
- Keep the glass close to the dispenser to prevent ice from spilling.

### Dispensing refrigerated water

- Due to air in the water supply line, refrigerated water may not be available immediately after installation. In this case, hold the dispenser lever pressed in for as long as two minutes to evacuate any remaining air.
- After that, the supplied water will become increasingly cooler.
- Refrigerated water does not contain any ice cubes. To lower the temperature of the refrigerated water, add crushed ice or ice cubes to it.



**Caution:** Keep fingers and objects away from the dispenser.

# Dispenser precautions

## Precautions

The following instructions refer only to products equipped with an ice cube maker, ice crusher and refrigerated water dispenser.

- Do not use very tall or short glasses.
- Hold the glass as close as possible to the ice cube outlet so as to prevent dropping ice cubes or jamming the ice cube supply.
- The outlet closes five seconds after ice cubes have been supplied.
- When helping yourself to ice cubes, hold the glass under the outlet for 2 to 3 seconds after releasing the switch, as more ice cubes may be delivered.
- When helping yourself to water, hold the glass under the outlet for 10 to 20 seconds after releasing the switch, as more water may be delivered.
- Regularly empty the water collection tray and wipe off water drops from the dispenser using a rag.
- When selecting ice cubes after crushed ice was last dispensed, a few remaining pieces of crushed ice may be delivered.
- Remove any remaining ice shavings from the outlet to prevent jamming.
- Do not place drinks or other foods in the ice cube container, as this may damage the ice maker.
- To avoid injuries, do not touch the ice outlet with your hand and do not remove the ice maker cover.
- Do not consume the first seven or so glasses of water and 20 or so ice cubes after starting up the appliance for the first time or following a long period of inoperation.
- Do not place ice cubes other than the ones produced by the appliance in the ice cube container, as they may not be properly delivered or crushed.
- An insufficient water supply line may cause ice cubes to be too small. An excessive water supply line may cause ice cubes to be too large. Moreover, water may overflow into the ice cube container, causing the ice cubes to stick together. Adjust the faucet accordingly or contact an authorised professional.



Caution: The valve and relay may produce audible sounds while ice cubes are being supplied



# Defrosting · Cleaning

## Defrosting

The appliance defrosts automatically.

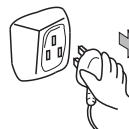

## Cleaning

Clean the refrigerator regularly to prevent odour build-up.

- For safety reasons, first unplug the power cord.
- Clean the appliance using a soft rag or sponge and lukewarm water, to which you may add a little bit of a neutral dishwashing liquid.
- Dry off surface water with a rag.



Caution: Do not use pointed objects, metal brushes or the following chemical solvents:  
abrasive cleansers, varnish, amyl acetate, hot water, acid, alkaline cleaners, etc.



Caution: Do not pour water onto the appliance.  
Use a rag or sponge to clean and dry the controls and lights.

- Be sure to clean the door seal regularly.



# Inoperation

## In the event of a power outage

Even in the summer, foods can be kept cool for several hours during a power outage.

In the event of a power outage, refrain from adding foods to the appliance and opening the doors.

### Caution:

- A temperature drop in the freezer compartment, caused by a power outage or other malfunction, reduces the storage life span and quality of the foods.
- If you know there will be a power outage, produce more ice cubes and place them in the top section of the refrigerator.

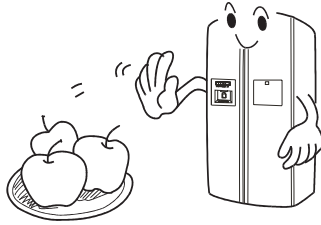

### Caution:

A temperature drop in the freezer compartment, caused by a power outage or other malfunction, reduces the storage life span and quality of the foods.

## Putting the appliance out of operation

If the appliance is to remain idle for a long period of time, you must press the power button and unplug the power cord.

Clean the appliance as described. During the period of inoperation the doors must be left open to prevent odour build-up.

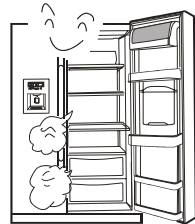

**Caution:** Avoid putting the appliance out of operation, as this will shorten its life expectancy.



**Caution:** Wait at least five minutes before turning on the appliance after turning it off.

# Inoperation

## When on vacation

- Before a long vacation, turn off the appliance, take out the food, remove the frost, clean the interior and leave the door open to prevent odour build-up.



## Transportation

- Unplug the power cord.
- Remove all foods from the refrigerator.
- Secure the shelves, drawers and baskets with tape.
- Close the appliance door and secure it with tape.
- During transportation, do not tilt the appliance more than 45° (in relation to the vertical position), otherwise malfunctions of the refrigeration system may be caused.

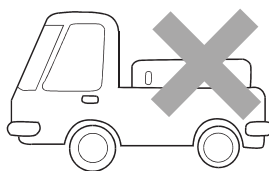
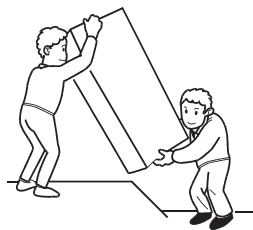

Caution:

Do not carry the appliance or let it stand horizontally.

# Troubleshooting

Long operation time and a temperature increase of housing and compressor are normal during initial operation.

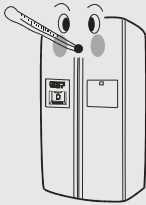

Some of the sounds produced during initial operation or at start-up will fade during normal operation.

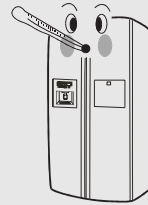

During initial operation, the appliance housing may become warm to prevent condensation.

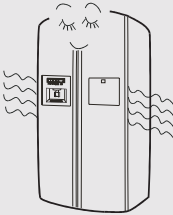

At start-up and during operation, the compressor may produce an audible sound when starting or stopping

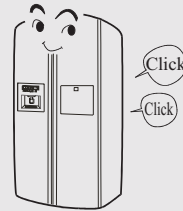

The sound of the refrigerant flowing through the evaporator and compressor is normal. A continuous or intermittent flowing sound after operation is normal.

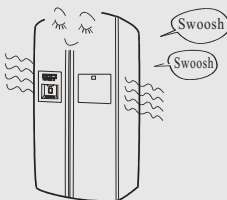

During the defrosting process, thaw water may drip onto the heating elements, causing audible sounds in the evaporator.

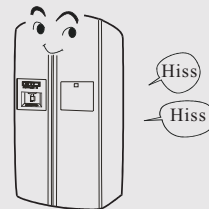

# Troubleshooting

When operating, the fan produces an audible sound.

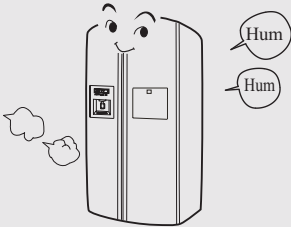

The specified power consumption at an ambient temperature of 25°C with 5°C in the refrigerator and -18°C in the freezer after 24 hours of normal operation complies with government standards. Higher power consumption is normal with large amounts of food in the freezer and when the appliance door is opened frequently or for long times.

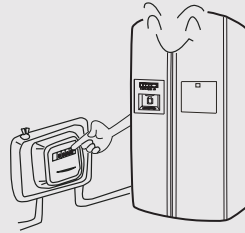

The evaporator lines may produce audible sounds when the temperature is changing.

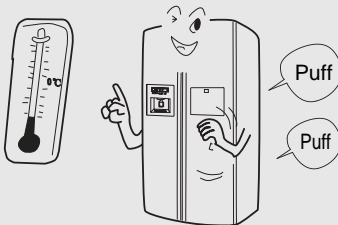

Wipe off any condensation that may form on the exterior housing and centre beam at high humidity with a soft cloth.

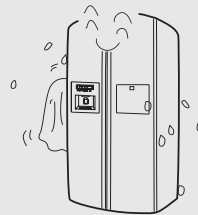

# Customer service

Should a malfunction occur that you cannot resolve as described below, contact the nearest customer service. In such a case, please indicate the full model name, serial number and spare part register. (See the product label at the back of the appliance.)



Confirm the following before ordering a repair.

## Unit does not cool



The appliance is not connected to the power (plug, outlet, fuse) or is switched off.



Voltage too low.

## Light does not come on



Bulb is burned out.



The appliance is not connected to the power.

## Unusual noises

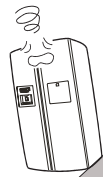

Caution: Do not carry the appliance or let it touching the wall or other object.

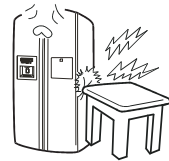

## Temperature is not cold enough

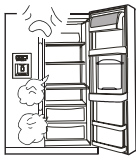

Appliance door not fully closed, opened too frequently or for too long.

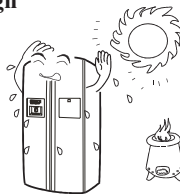

Exposed to direct sunshine, a stove or other heat source.



Poor ventilation. The back or sides of the appliance are blocked.

# After-sales Service

## Confirm the following before ordering a repair.

### Compressor runs often or for a long time

- This is normal during initial operation.
- Normal after loading with large amounts of foods.
- Appliance door not fully closed.
- Appliance door is opened frequently.
- Ambient temperature is high.
- Wrong temperature setting. See “Starting up”.
- Poor ventilation

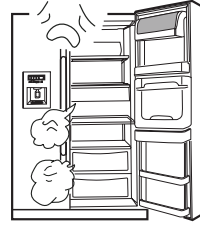

### Foods are covered with frost or ice

- Normal if unpackaged food was placed in the freezer.
- Appliance door not fully closed.
- Appliance door is opened too frequently or for too long.
- Food placed too close to air outlet.

### Unusual odour

- Strongly smelling food is not packed appropriately.
- Food has spoiled.
- The appliance interior needs to be cleaned.



### Ice maker does not work properly.

- Ice cubes stick together. Take out the lump of ice cubes, crush it and return only the separated ice cubes to the ice cube container.

- Adjust the ice maker water supply if the ice cubes are too small or too large.

- Ice cubes may end up sticking together if stored for too long.

- In the case of a power outage, empty, clean, dry and re-place the ice cube container to avoid that the ice cubes melt and drip into the freezer compartment.

## Customer service

### Dispenser not supplying

- No ice cubes in the ice cube container. Wait until ice cubes are supplied.
- The freezer temperature is set too high. Lower the freezer temperature to improve the performance of the ice cube maker.
- The water supply valve is closed. Open the water supply valve.
- The freezer or refrigerator door is not fully closed. Close all appliance doors.

### Dispenser jammed

- Defrosting water has frozen on the spindle due to long period of idleness, large temperature swings or voltage peaks. Empty, clean, wipe and re-place the ice cube container.
- Ice cubes are jammed between the ice cube maker and container. Remove the ice cubes.
- Ice cubes are stuck together. Use the dispenser more frequently.
- Other ice cubes were placed in the dispenser. Only the ice cubes produced by the ice maker can be used by the dispenser





The  symbol on the product or on its packaging indicates that this product is not to be treated as regular household waste. Instead, it must be taken to a recycling collection point for electrical and electronic equipment. By properly disposing of this product, you are contributing to the preservation of the environment and the wellbeing of your fellow citizens. Improper disposal is hazardous to health and environment. You can obtain further information on how to recycle this product from your municipality, your waste management service or the shop where you purchased it.



