



Model HF-299

Domestic Refrigerator Operation Instructions

Contents	1-2
Name of various components	3
Placing environment	4
Usage preparation	5-6
Begin to use	7
Function introduction	8-9
Freezer usage instruction	10-11
Defrosting, cleaning, and stopping use	12-13
Question solution, after-sales service	14

The names of various components

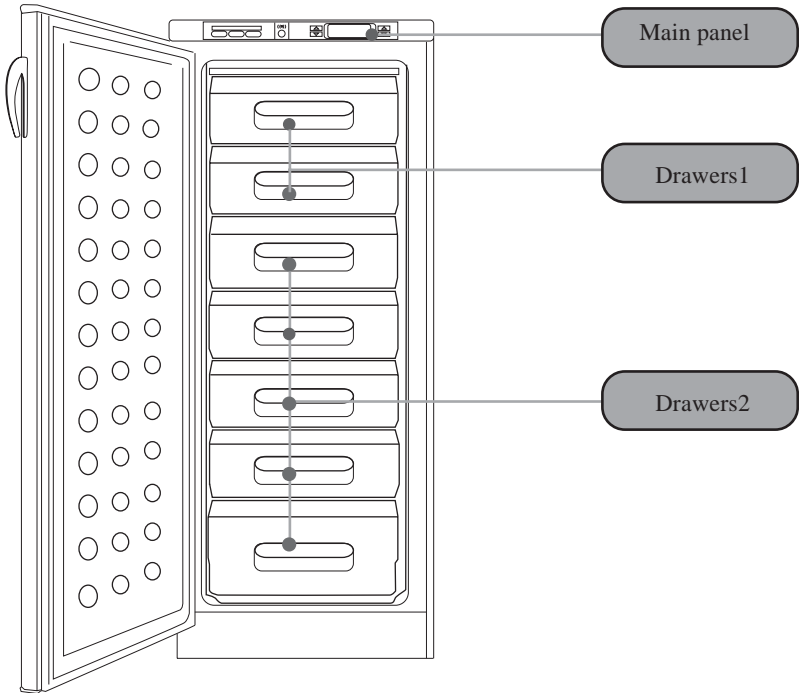

Due to product modification, your purchased Haier refrigerator may not be identical with the one shown in the manual. We hereby express our apologies to you for this possible difference.

Placing environment

- The refrigerator should be placed on even, solid ground. When it is necessary to make it level by insert something to raise it, the insert chosen should be steady, hard, and incombustible. It is absolutely prohibited to use package foam block of the appliance as the insert. If it is not level, you can make it level by turning and adjusting the bottom foot of the refrigerator.

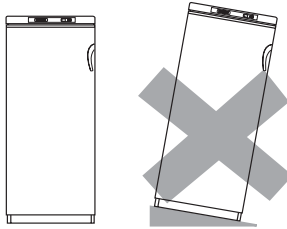

- It should be located in a well-ventilated place, and there should be at least 10cm of free space surrounding the refrigerator including its back.

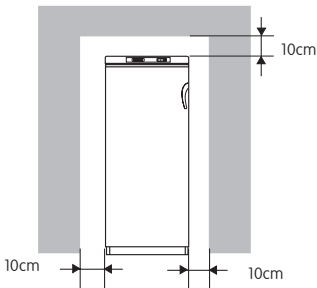

- Refrigerator should be kept far from heat source and avoid direct sunshine.

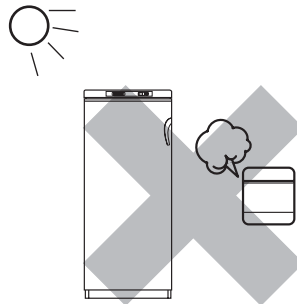

- Be sure not to put in such a cold environment as to freeze water

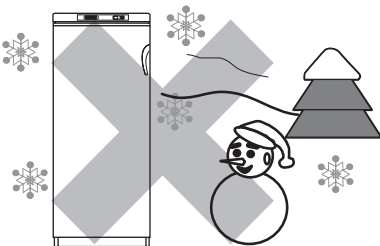

- Do not place it in area damp or susceptible to be splashed with water.

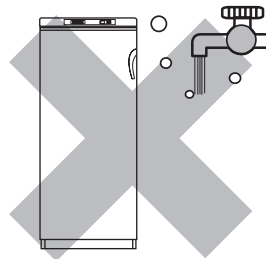

Usage preparation

Remove all package parts

Including foam base and the adhesive tape fixing accessories, they all must be removed to prevent the appliance being placed uneven.

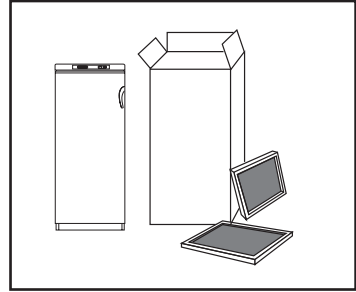

Check accompanying accessories and document

Check the items inside the package box with the packaging list, and inquire selling shop, if any discrepancy.

Locate the refrigerator on proper place

(See section "placing environment")

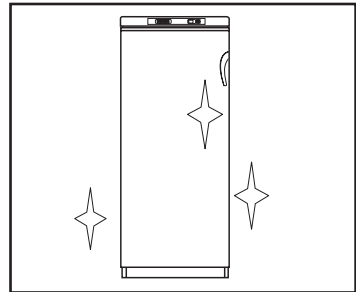

It is advisable to carry out cleaning prior to usage

(See latter section "cleaning" for its detailed description)

Idle standing

After the appliance has been adjusted level, and cleaned, let it remain idle for at least 30 minutes before switching it on so as to ensure its normal running.

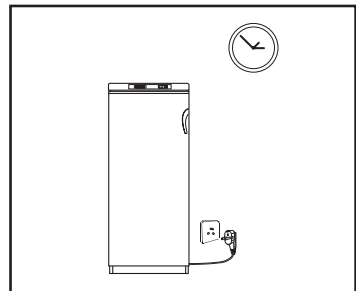

Usage preparation

Left/right door opening function

This product provides the function of left/right door opening, so you can realize the function of opening door from right side by the following step according to actual necessity.

1. Dismantle three screws of lower door hinge for later use.
2. Carefully move downward and take out the door, and carefully put it aside.
3. Dismantle part①, install it on right corresponding position, and tighten it.
4. Dismantle part③, and fix it in the left hole of the lower hinge②.
5. Use tool such as wrench to dismantle upper hinge axle④, and install it on right corresponding position.
6. Take the door, and carefully install it over the hinge axle④.
7. Install the three screws dismantle in step 1 to the left lower door hinge②.
8. Dismantle the hole-cover of door handle for later use.
9. Dismantle door screw cover and screw⑦, and install door handle⑤ on the right corresponding position, then tighten it. Install the hole cover taken in step 8 on the right side.
10. After completing installation of the door, repeat opening and closing door for several times, to ensure no abnormal noise, and tight installation of all screws and hinge axles.

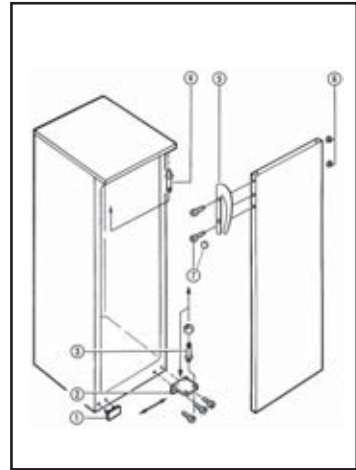

Begin to use

1.Starting of the appliance

- For the initial use of the freezer, it is required to start it at least 3hours in advance of putting food.
- Switching on the appliance. When plugged in, the appliance shall automatically be set to position 3, and quick cooling to position 0, green power light I shall be turned on, and at the same time, red alarming light L shall be turned on together with buzzing sound. Press the buzzer can stop the buzzing sound. Green power light I indicates whether the appliance is switched on or not.

When the temperature of the appliance has been lowered to required limit, green alarming light L shall be automatically be turned off.

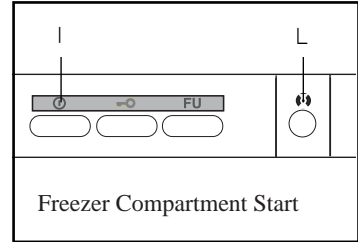

2.Appliance working method

Suggestion !

No matter how ambient temperature changes, it can maintain optimum refrigeration effect without any other adjustment so long as you have selected the artificial intelligence, giving you much convenience.

You can set the appliance by selecting one of the two modes according to necessity.

(1) Artificial intelligence mode: if no other special demand, we recommend you to use the artificial intelligence. By pressing the artificial intelligence key to turn its indicating light on, then the appliance shall automatically work.

(2) Manual adjusting mode: you can adjust and set the freezer temperature position according to food storage necessity (such as for quick freezing). (See the following "temperature setting and adjustment" in the later section of "function introduction").

Function introduction

Introduction of main panel

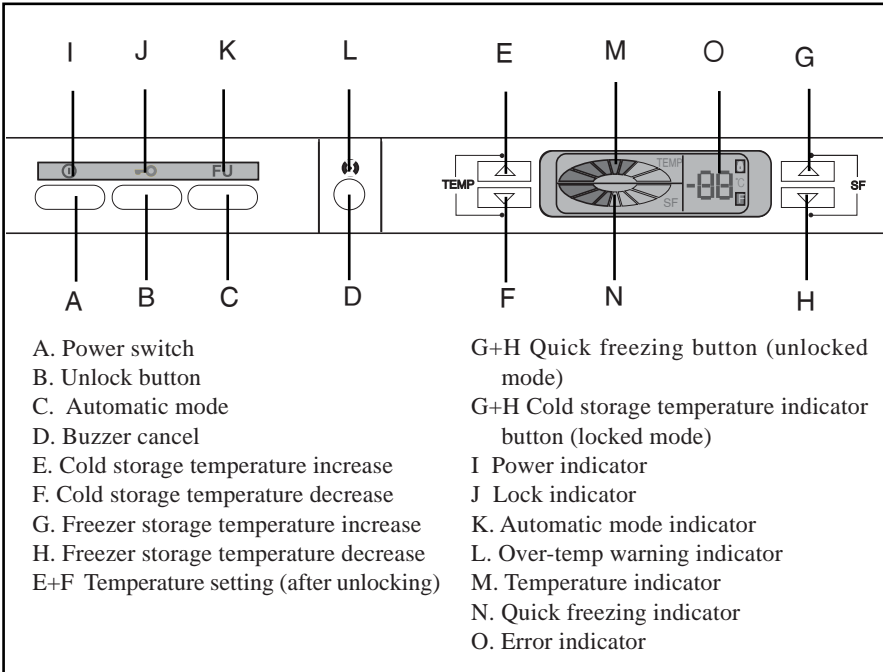

Power control

After switching on the appliance, green power light I on the above of power switch A shall be turned on. In order to prevent misoperation, it is necessary to press key A for 3 seconds in order to stop its power supply, then the indicating lights and display windows shall all be turned off, it shall stop cooling. If pressing the power key A again, the appliance shall resume working, and all indicating lights and windows shall all be turned on again.

Locking and release

After switching on, the appliance shall automatically enter a locking state, light J shall be turned off; by pressing key B, the locking shall be released, and light J shall be turned on.

Artificial intelligence setting

Under the artificial intelligence state, the appliance shall automatically adjust temperature control position according to the ambient temperature changes, without manual control. Press key C, and light K shall be turned on to enter the artificial intelligence state. Then quick freezing position is on 0 and it is impossible to set quick cooling. Also the temperature position is impossible to be set. To stop the state, press key C continuously for 3 seconds. At this moment, light K shall be turned off.

Function introduction

Quick cooling setting

The quick cooling function is designed to keep food nutrition value. It can make the food become completely frozen within as short time as possible. By pressing keys G+H together at the same time for 3 seconds, the previous quick cooling setting position indicating light shall flash. At this time, for each pressing of Δ (key G), it shall increase 1 position from its previous position. And for each pressing of ∇ (key H), the position shall decrease by one step (in the range of positions 0-2). When under the quick cooling state, after compressor has cumulatively worked for some period of time, it shall automatically stop the quick cooling state, to resume quick cooling position 0.

Note: When quick cooling position is on 0, the position indicating light shall flash 3 squares successively from left to right.

Temperature setting and adjustment

Pressing the keys E+F at the same time for 3 seconds, current temperature setting position shall flash. Then each pressing of Δ (key E), the position shall be increased one position on the current position. And for each pressing of ∇ (key F), position shall be lowered one step (in the range of positions 1 to 7).

Over temperature alarming function

When the actual temperature sensed by freezing sensor is higher than -5°C (excluding -5°C), the over-temperature alarming light shall be continuously on, together with the sound of buzzing. Press the buzzer release key D to release the buzzing, but the red over-temperature indicating L shall be still on. When the temperature of the freezer is lowered to -5°C or lower, the red over-temperature indicating light L shall be automatically turned off.

Power-off memory

The instantaneous working state at power failure shall be locked, and after power is restored it will work according to the setting before the power failure.

Average temperature and malfunction display

Average temperature can be displayed only when locking indicating light is turned on. Pressing the keys E+F at the same time, it is possible to display the instantaneous temperature of the freezer.

Malfunction display:

- (1) When there is malfunction in the environment sensor, the appliance shall be impossible to enter artificial intelligence state, and shall display "F2".
- (2) When there is malfunction on the freezing sensor, compressor shall enter the fixed cycle of working for 20 minutes, then stop for 20 minutes and so on", but quick cooling function is still effective, but over-temperature alarming shall be out of order, with display of "F1".

Freezer usage instruction

Use freezer for those foods to be stored for long time.

The temperature of freezer compartment can be -18°C , or lower, and under such a low temperature it can basically inhibit the growth or reproduction of bacteria. So it is advisable to store in this room those foods to be kept for long time, but careful with shelf life indicated on the food package.

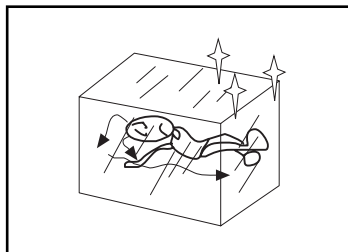

Quick-freezing

Before putting a larger amount of fresh food in the freezer compartment, it is possible to use its quick freezing function (see the description of "quick freezing" in the above section of "function introduction"). But it shall not be necessary to set the quick-freezing function for the foodstuff whose weight is less than 1kg or the food that has already been frozen.

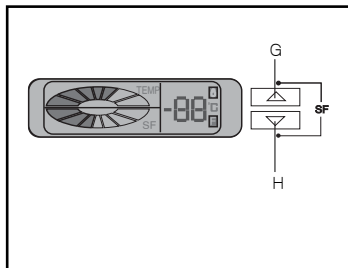

Making ice cubes

- Pour about 3/4 of the volume of the icebox of water to put in the freezer compartment for freezing
- When taking out the icebox, be sure not to use knife or other metal tool for picking. Generally, it can be taken down by slight force. After taking out icebox, put it in warm water for a while, and turn it with hand to take out ice cubes.

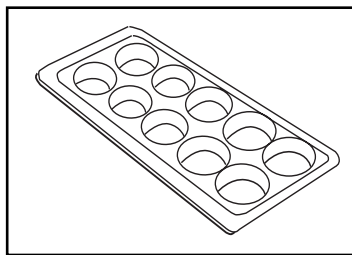

Key to freezing food

- It is advisable not to put excessive amount of fresh food in freezer compartment, preferably, not exceeding freezing capacity of the appliance.
- Hot food should be cooled to room temperature before putting in the freezer compartment.
- Food should be divided into small appropriate portions, so as to make it easier to be frozen completely, and also to better guarantee quality at melting and cooking. It is advisable for each portion not to exceed 2.5kg.

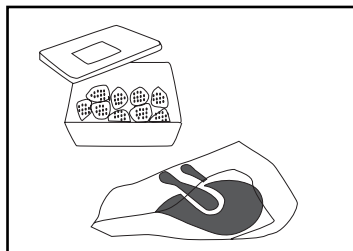

Freezer usage instruction

- It shall be better to package the food prior to freezing it, and the package surface should be dry to avoid being frozen together. The package material should be smell-free, airtight, watertight, non-toxic, and pollution -free, to prevent food flavor contamination or quality deterioration. It is advisable to mark the freezing date, storage permissible period and food name on package bags according to different food's shelf life so as to avoid exceeding the storage limit.

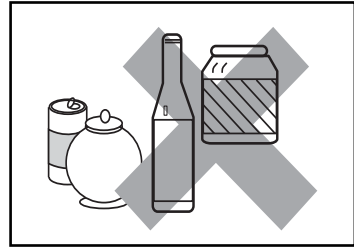

- In principle, take out exact required amount of food from freezer compartment for melting. Melted frozen food can not be re-frozen again, unless it has been processed into cooked food, otherwise its eating quality shall be influenced.

- Take care not to put bottled beer, or beverage in the appliance to prevent frost crack.

Method for taking out drawer

Pull forward it as shown in the drawing, and then slightly raise it to take it out.

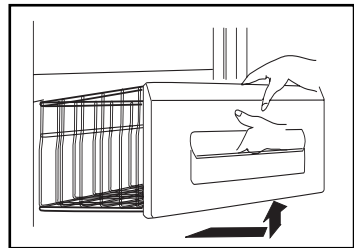

Defrosting, cleaning, stopping use

Defrosting

- The freezer compartment is required to be manually defrosted. After some time of using the appliance, a layer of frost shall be formed on the evaporator plate of the freezer compartment, and it will consume more power if the layer gets too thick. So when it has thick frost, it is required to carry out defrosting with plastic scraper.
- When carrying out defrosting, first pull out its power plug to switch it off, wrap up the foodstuff in cotton blanket and place them in cool place. Then take out drawers.
- As shown in the drawing, pull out the freezer outlet tube ① of the discharge assembly. Place a container ② at the outlet (or align the ① with the back opening of lower freezer drawer) so as to collect defrosted water. In order to speed the defrosting process, it is possible to place a bowl of hot water on the evaporator plate.

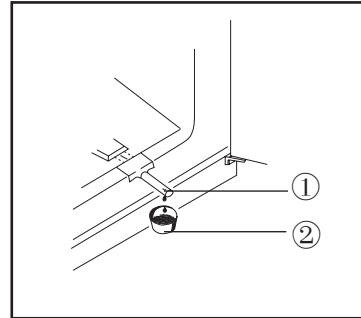

Note: it is strictly prohibited to carry out defrosting with metal tool or electric heater, to prevent damaging appliance.

Treatment at power failure

When there is no power supply, the refrigerator can still keep food without question for several hours, even in summer.

- At power failure, do not put any more new fresh food.
- Do the best not to open appliance doors.
- If power stop is known in advance, it is advisable to make many ice, put ice cube on the top of freezer compartment.
- Please note: Temperature rising in the freezer compartment caused by power interruption or other malfunction can shorten food storage period, and deteriorate food quality.

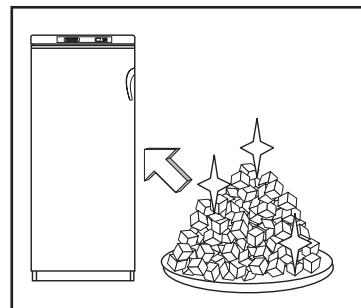

Defrosting, cleaning, stopping use

Cleaning

The food remained in the refrigerator can produce unpleasant smell, so it is required to carry out periodical cleaning.

- For safety, pull out power plug prior to cleaning.
- Clean the appliance by using soft towel or by sponge dipping in warm water. (It is permissible to add mild detergent). Be sure not to use scrub-brush, steel brush, or organic solution such as household cleanser, gasoline, banana oil, acetone, benzole, or hot water, acid or alkali.
- Use a dry cloth to wipe the water on the surface of refrigerator

(1) Even for cleaning, do not spray water in order to avoid affecting electric insulation feature.

(2) When cleaning such electric components as "switch", "lamp" and "thermostat", use drier rag or sponge

- Door gasket is easy to get dirty, be sure to frequently keep it clean.
- Frequently remove the dust on the side plates, to improve heat-expelling efficiency.

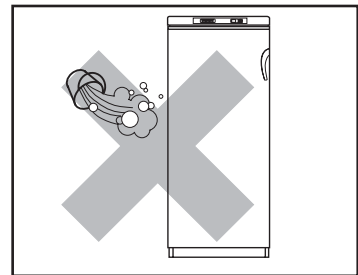
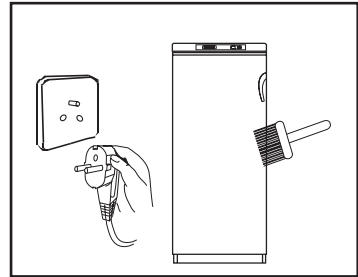

Stop usage

If the appliance is not to be in use for a longer time, it is advisable to pull out power plug, disconnect it with power supply, and carry out cleaning for the appliance as described in the above method.

When the refrigerator is not in usage for long time, be sure to leave its door open, to prevent food producing unpleasant smell.

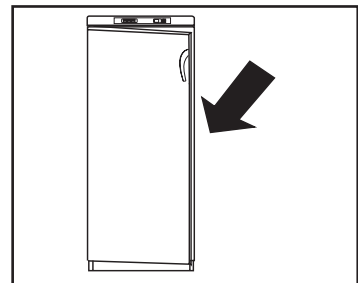

Note: generally, do not stop using refrigerator to avoid affect its usage life.

Question solution, after-sales service

The following should not be regarded as defects.

- When the appliance is first used, it can have longer working time and higher temperature inside the appliance, and also compressor can have high temperature. All these are normal.
- When air humidity is high, the appliance outside may have water drops, just wipe them with soft cloth.
- In humid season, when door is opened too frequently, or be kept open for too long time, humidity is likely to be present in the appliance.
- Refrigerant flowing in the refrigerator gives out some sound. When refrigerator starts or stops, compressor clicks.
- It is normal for the front of the appliance side panel to give heat.
- When putting food or at higher ambient temperature, the appliance shall automatically increase starting time.

Note: after switching it off, wait for at least 5 minutes before switching it on again.

Before calling for repair, make certain the following items:

Question	Possible cause
Appliance not working	<ul style="list-style-type: none">● Whether power supply is connected (plug, socket, fuse, etc)● Whether power voltage is too low?
Too much noise	<ul style="list-style-type: none">● Whether ground is even?● Whether some part of the appliance has been in contact with external object, or with the building wall
Compressor runs for long time or temperature inside cabinet is not desirably low	<ul style="list-style-type: none">● It is normal to have long time running for the first time usage.● There is large amount of food to be cooled● At hot weather, the appliance door is opened too frequently.● Thermostat temperature setting is incorrect.● Whether its placing is subject to the direct sunshine, or too near the heat source such as stove, heating● Whether ventilation is bad, whether back condenser is too dirty
Food getting dry	<ul style="list-style-type: none">● Food is not covered well, without package or not sealed well.
There is frost or ice flowers on frozen food	<ul style="list-style-type: none">● Appliance door is kept slightly open, or food has kept door open● Door is opened too frequently or for long time.● It is normal for frost or ice to form on the food package.
There is bad smell in the appliance	<ul style="list-style-type: none">● Smelly food has not been packaged closely.● Check for spoiled food● It is necessary to carry out refrigerator interior cleaning. See section of "cleaning".