

Haier®
What The World Comes Home To™

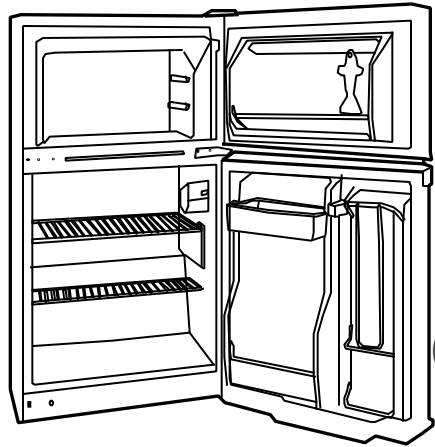

Two Door Compact
Refrigerator

Réfrigérateur

Compact De Deux Portes

Refrigerador

Compacto De Dos Puertas

User Manual-

Model

Guide de l'Utilisateur-

Modèle

Manual del Usuario-

Para Modelo de

HDE03WNA

English

SAFETY PRECAUTIONS

**Read all of the instructions before using this appliance.
When using this appliance, always exercise basic safety precautions, including the following:**

- 1) Use this appliance only for its intended purpose as described in this use and care guide.
- 2) This refrigerator must be properly installed in accordance with the installation instructions before it is used. See grounding instructions in the installation section.
- 3) Never unplug your refrigerator by pulling on the power cord. Always grasp the plug firmly and pull straight out from the outlet.
- 4) Repair or replace immediately, all electric service cords that have become frayed or otherwise damaged. Do not use a cord that shows cracks or abrasion damage along its length, the plug or the connector end.
- 5) Unplug your refrigerator before cleaning or before making any repairs.
Note: *If for any reason this product requires service, we strongly recommend that a certified technician performs the service.*
- 6) Do not use any electrical device or any sharp instrument in defrosting your refrigerator.
- 7) If your old refrigerator is not being used, we recommend that you remove the doors and leave the shelves in place. This will reduce the possibility of danger to children.
- 8) After your refrigerator is in operation, do not touch the cold surfaces in the freezer compartment, particularly when hands are damp or wet. Skin may adhere to these extremely cold surfaces.
- 9) Do not refreeze foods, which have been thawed completely. The United States Department of Agriculture in Home and Garden Bulletin No. 69 reads: "...You may safely refreeze frozen foods that have thawed if they still contain ice crystals or if they are still cold-below 40°F".

"...Thawed ground meats, poultry, or fish that have any off-odor or off-color should not be refrozen and should not be eaten. Thawed ice cream should be discarded. If the odor or color of any food is poor or questionable, discard it. The food may be dangerous to eat."

"...Even partial thawing and re-freezing reduce the eating quality of foods, particularly fruits, vegetables, and prepared foods. The eating quality of red meats is affected less than that of many other foods. Use refrozen foods as soon as possible, to save as much of its eating quality as you can."

- 10) This refrigerator should not be recessed or built-in an enclosed cabinet. It is designed for freestanding installation only.
- 11) Do not operate your refrigerator in the presence of explosive fumes.

SAVE THESE INSTRUCTIONS For Future Reference

DANGER

**Risk of child entrapment. Before you throw away your old refrigerator or freezer, take off the doors. Leave the shelves in place so that children may not easily climb inside.
As per UL 250 Standards**

Thank you for using our Haier product. This easy-to-use manual will guide you in getting the best use of your refrigerator.

Remember to record the model and serial number. They are on a label in back of the refrigerator.

_____ *Model number*

_____ *Serial number*

_____ *Date of purchase*

Staple your receipt to your manual. **You will need it to obtain warranty service.**

English

Table Of Contents

	PAGE
Safety Precautions	1
Parts And Features	4
Installing Your Refrigerator	5
Unpacking Your Refrigerator	5
Leveling Your Refrigerator	5
Proper Air Circulation	5
Electrical Requirements.....	6
Door Alignment.....	7
Reversing the Door Swing	8
Refrigerator Features And Use	10
General Features.....	10
Refrigerator Interior Shelves.....	10
Defrosting Your Refrigerator.....	11
Food Storage Information	12
Normal Operating Sounds.....	13
Proper Refrigerator Care and Cleaning	14
Cleaning and Maintenance	14
Light Bulb Replacement	15
Power Interruptions	15
Vacation and Moving Care	15
Troubleshooting	16
Warranty Information	18

Parts And Features

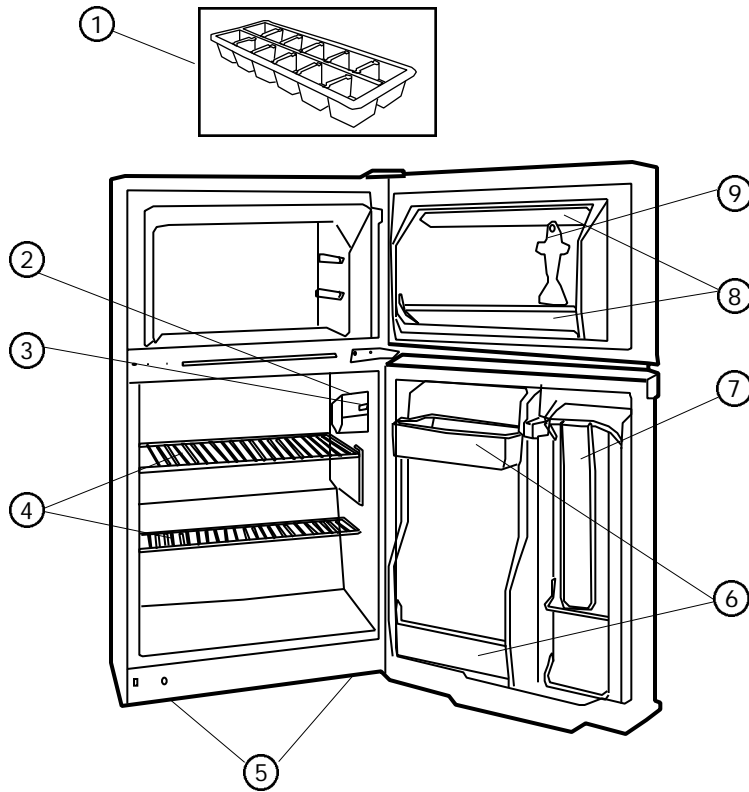

- | | |
|--|----------------------------------|
| 1. Ice Cube Tray | 6. Refrigerator Door Shelves |
| 2. Automatic Interior Light | 7. "Dispense-A-Can™" Can Storage |
| 3. Temperature Control | 8. Freezer Door Shelves |
| 4. Refrigerator Shelves | 9. Ice Scraper |
| 5. Adjustable Front Leveling Legs
(not shown) | |

English

Installing Your Refrigerator

Unpacking Your Refrigerator

1. Remove all packaging material. This includes the foam base and all adhesive tape holding the refrigerator accessories inside and outside. Slide out and remove plastic or foam guard used to secure the compressor from shipping damage due to vibration and shock.
2. Inspect and remove any remains of packing, tape or printed materials before powering on the refrigerator.

Leveling Your Refrigerator

- Your refrigerator has two leveling legs which are located in the front corners of your refrigerator. After properly placing your refrigerator in its final position, you can level your refrigerator.
- Leveling legs can be adjusted by turning them clockwise to raise your refrigerator or by turning them counterclockwise to lower your refrigerator. The refrigerator door will close easier when the leveling legs are raised.

Proper Air Circulation

- To assure your refrigerator works at the maximum efficiency it was designed for, you should install it in a location where there is proper air circulation, plumbing and electrical connections.
- The following are recommended clearances around the refrigerator:

Sides.....3/4 "(19mm)

Top.....1" (25mm)

Back.....1" (25mm)

Electrical Requirement

- Make sure there is a suitable power Outlet (115 volts, 15 amps outlet) with proper grounding to power the refrigerator.
- Avoid the use of three plug adapters or cutting off the third grounding in order to accommodate a two plug outlet. This is a dangerous practice since it provides no effective grounding for the refrigerator and may result in shock hazard.

Install Limitations

- Do not install your refrigerator in any location not properly insulated or heated e.g. garage etc. Your refrigerator was not designed to operate in temperature settings below 55° Fahrenheit.
- Select a suitable location for the refrigerator on a hard even surface away from direct sunlight or heat source e.g. radiators, baseboard heaters, cooking appliances etc. Any floor unevenness should be corrected with the leveling legs located on the front bottom corners of the refrigerator.

English

Door Alignment

Freezer Door: (see fig. # 1)

1. Remove the top hinge cover.
2. Loosen the top hinge screws using a phillips head screwdriver.
3. Adjust the door or put a spacer in between and then tighten the screws.
4. Replace the top hinge cover.

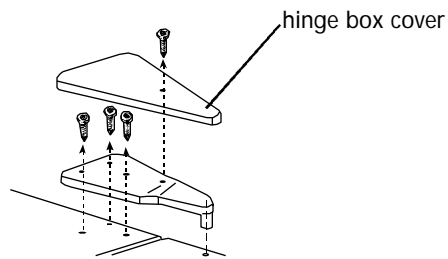

fig. # 1

Refrigerator Door: (see fig. # 2)

1. Loosen and remove the bottom hinge using a phillips head screwdriver.
2. Adjust the door, or put a spacer in between and then tighten the screws.

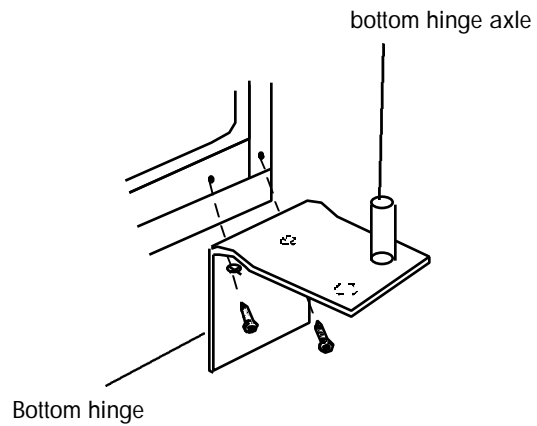

fig. # 2

Reversing the Door Swing

Left/right door opening method:

This product provides the reversing of the left/right door opening. You can select your preference of door opening by following the procedure to make the change.

Dismantling: (see fig. # 1 and fig. # 3)

1. Fix refrigerator and freezer door by sticking adhesive tape on both sides to hold doors in place.
2. As shown in fig. 1, dismantle the hinge box cover on the upper part of freezer door. Then remove the three screws from the hinge. Take out the hinge by pulling it vertically, and keep it in a safe place.
3. Remove the adhesive tape on freezer door, lift and take the door down, and carefully put it aside.
4. As shown in fig. 3, dismantle two screws of the central hinge, lift and take down the central hinge, and keep it in a safe place.
5. Remove the adhesive tape on refrigerator door, lift and take down refrigerator door, and carefully put it aside.

fig. # 3

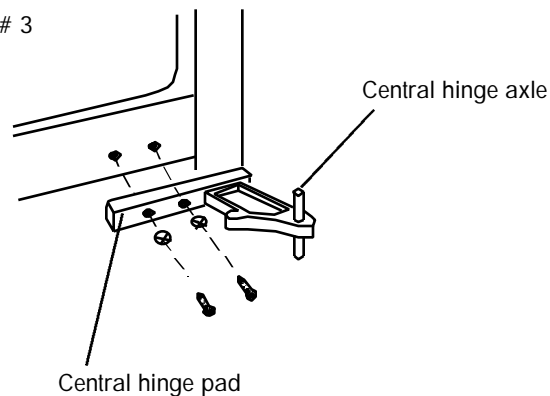

English

Reinstallation: (see fig. # 4 and # 5)

1. Remove the lower pivot pin from the bracket of the lower hinge by turning counter clockwise. Move the pin to the opposite hole and tighten.
2. Loosen the screws holding the lower hinge bracket and remove the hinge.

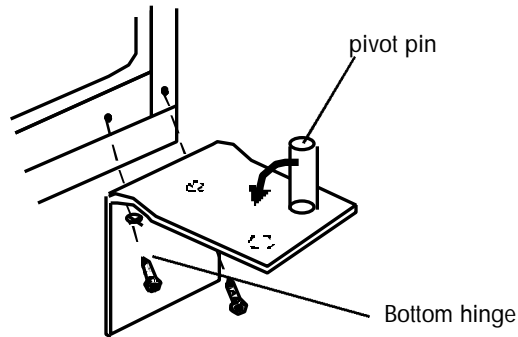

fig. # 4

3. Align the holes in the lower hinge bracket to the corresponding holes in the opposite side of the cabinet. Insert and tighten the screws.
4. To install refrigerator door: make the left bottom hole of the refrigerator compartment door fall over the lower hinge axle, move door forward to make it straight and in alignment with central hinge. Install the central hinge again, turn the hinge axle until it completely enters the door body, then fix it with screws.

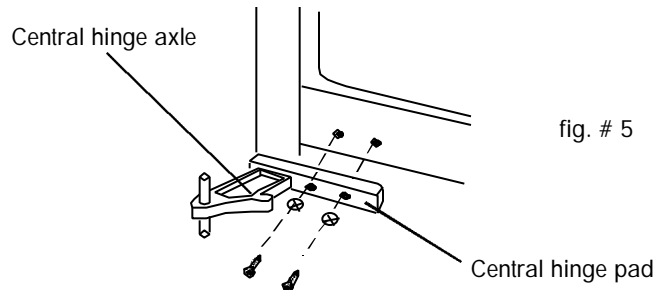

fig. # 5

5. To install freezer door: make the left bottom hole of freezer door fall over the central hinge axle; raise upper hinge, so that hinge axle can be installed in the upper hole of the upper part of the freezer door; adjust door to make it straight and level.
6. As shown in Fig. 1, install the upper freezer hinge to the left corresponding position. (tighten the screws of upper hinge)
7. Replace the hinge cover as shown in Fig. 1.

Refrigerator Features And Use

General Features

Adjustable temperature dial:

Your refrigerator will automatically maintain the temperature level you select. The temperature control dial has 7 settings plus off. 1 is the warmest. 7 is the coldest. Turning the dial to OFF stops cooling in both the refrigeration and freezer sections. At first, set the dial to 4 and allow 24 hours to pass before adjusting the temperature to your needs.

(Note: If the refrigerator has been placed in a horizontal or tilted position for any period of time wait 24 hours before plugging the unit in.)

Refrigerator Section Interior Light:

Your refrigerator is equipped with an automatic interior light in the fresh food section for you to easily locate your food.

Refrigerator Interior Shelves

The refrigerator shelves of your refrigerator were designed with you in mind.

To remove or adjust a full-width slide-out shelf: (see fig. # 6)

1. Gently tilt the shelf up and slide forward until the shelf has been completely removed.
2. To replace the shelf, gently slide the shelf back until it rests in the locking position.

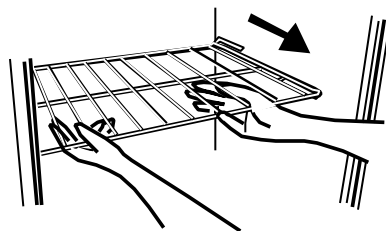
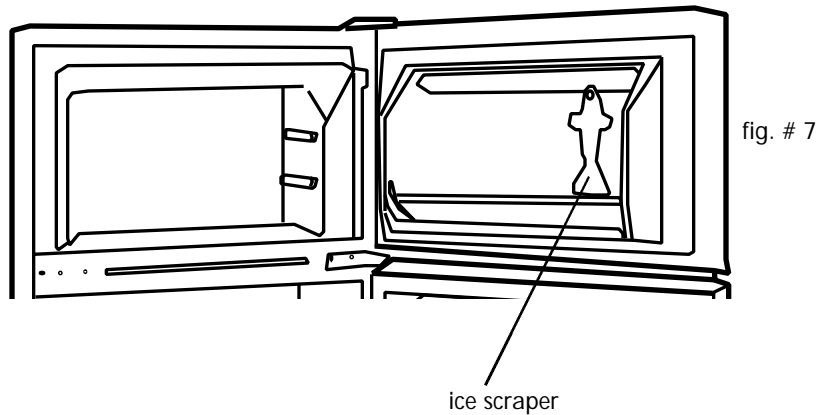

fig. # 6

Defrosting Your Refrigerator (see Fig. # 7)

- For maximum energy efficiency, defrost freezer section whenever frost accumulates to a thickness of 1/4" or more on freezer walls. Note that frost tends to accumulate more during the summer months.
- To defrost freezer, remove food and ice cube tray from the freezer section. Turn temperature control dial to OFF position. Defrosting may take a few hours. To speed up defrost time, keep the door open and place a bowl of warm water in the freezer.
- During the defrost, water will accumulate. Use a towel to wipe off excess dripping water. Do not leave unattended.
- After defrosting, empty and wipe down the interior of the freezer. You may now reset your refrigerator to the desired temperature and return food.
- Your freezer has been equipped with an ice scraper for your convenience.



Food Storage Information

Fresh Food

- When storing fresh food, which is not prepackaged, be sure to wrap or store food in airtight and moisture proof material unless otherwise noted. This will ensure proper shelf life and prevent the transfer of odors and tastes.
- Wipe containers before storing to avoid needless spills.
- Eggs should be stored in an upright position in their original carton to maximize shelf life.
- Fruit should be washed and dried then stored in a crisper set for low humidity. If you do not have humidity controlled crispers place the items in sealed plastic bags before storing in the crisper.
- Vegetables with skins should be stored in plastic bags or containers and stored in crisper with low humidity setting.
- Leafy vegetables should be washed and drained and then stored in plastic bags or containers in crisper with high humidity setting.
- Hot food should be allowed to cool before storing in the refrigeration. This will prevent unnecessary energy use.
- Fresh seafood should be used the same day as purchased.
- When storing meats in the fresh food section, keep in the original packaging or rewrap as necessary. Follow the suggestions below for safe storage:
 - Chicken 1-2 Days
 - Ground Beef 1-2 Days
 - Cold Cuts 3-5 Days
 - Steaks/Roasts 3-5 Days
 - Smoked/Cured Meats 7-10 Days
 - All others 1-2 Days

If longer periods of storage are required, store immediately in the freezer section.

English

Frozen Food

- Proper freezer storage requires correct packaging. All foods must be in packages, which do not allow the flow of air or moisture in, or out. Improper storage will result in odor and taste transfer and will result in the drying out of the improperly packaged food.
- Follow package or container instructions for proper storage.
- **Packaging Recommendations:**
 - Plastic containers with air tight lids
 - Heavy duty aluminum foil
 - Plastic wrap made from saran film
 - Self-sealing plastic bags
- Do not refreeze defrosted/thawed foods.
- It is recommended that the freezing date be marked on the packaging.

Normal Operating Sounds You May Hear

- The fan circulating air inside the interior of your unit to maintain the temperature you have selected.
- Boiling water, gurgling sounds or slight vibrations that are the result of the refrigerant circulating through the cooling coils.
- The thermostat control will click when it cycles on and off.

Proper Refrigerator Care and Cleaning

Cleaning and Maintenance

Warning: To avoid electric shock always unplug your refrigerator before cleaning. Ignoring this warning may result in death or injury.

Caution: Before using cleaning products, always read and follow manufacturer's instructions and warnings to avoid personal injury or product damage.

General:

- Prepare a cleaning solution of 3-4 tablespoons of baking soda mixed with warm water. Use sponge or soft cloth, dampened with the cleaning solution, to wipe down your refrigerator.
- Rinse with clean warm water and dry with a soft cloth.
- Do not use harsh chemicals, abrasives, ammonia, chlorine bleach, concentrated detergents, solvents or metal scouring pads. SOME of these chemicals may dissolve, damage and/or discolor your refrigerator.

Door Gaskets:

- Clean door gaskets every three months according to general instructions. Gaskets must be kept clean and pliable to assure a proper seal.
- Petroleum jelly applied lightly on the hinge side of gaskets will keep the gasket pliable and assure a good seal.

English

Light Bulb Replacement

1. Switch off power to refrigerator.
2. Remove the thermostat control knob.
3. Allow light bulb to cool before removing.
4. Pinch the plastic cover between fingers and thumb and gently pull to the left.
5. Remove the bulb by screwing it counter-clockwise.
6. Always replace with appliance type light bulb rated at 15 watts or lesser wattage.
7. Do not exceed the 15 watts rating at any time.
8. To replace cover, insert rear clips in first and gently push front clip in until the cover snaps into place.
9. Push the thermostat control knob back in place.

Power Interruptions

- Occasionally there may be power interruptions due to thunderstorms or other causes. Remove the power cord from AC outlet when a power outage occurs. When power has been restored, replug power cord to AC outlet. If outage is for a prolonged period, inspect and discard spoiled or thawed food in freezer and refrigerator. Clean refrigerator before reusing.

Vacation and Moving Care

- For long vacations or absences, empty food from refrigerator and freezer, move the temperature DIAL to the OFF position and clean the refrigerator and door gaskets according to "General cleaning" section. Prop doors open, so air can circulate inside. When moving always move the refrigerator vertically. Do not move with the unit lying down. Possible damage to the sealed system could occur.

Troubleshooting

Refrigerator Does Not Operate

- Check if thermostat control is not in the "OFF" position.
- Check if refrigerator is plugged in.
- Check if there is power at the ac outlet, by checking the circuit breaker.

Food temperature appears too warm

- Frequent door openings.
- Allow time for recently added warm food to reach fresh food or freezer temperature.
- Check gaskets for proper seal.
- Adjust temperature control to colder setting.

Food temperature is too cold

- If temperature control setting is too cold, adjust to a warmer setting and allow several hours for temperature to adjust.

Refrigerator runs too frequently

- This may be normal to maintain constant temperature during high temperature and humid days.
- Doors may have been opened frequently or for an extended period of time.
- Check gasket for proper seal.
- Check to see if doors are completely closed.

English

Moisture build up on interior or exterior of the refrigerator:

- This is normal during high humidity periods.
- Prolonged or frequent door openings.
- Check door gaskets for proper seal.

Refrigerator has an odor:

- Interior needs cleaning.
- Foods improperly wrapped or sealed are giving off odors.

Refrigerator light does not work:

- Check power supply.
- Tighten bulb in socket.
- Replace burned out bulb.

Refrigerator/Freezer door does not shut properly:

- Level the refrigerator.
- Re align refrigerator/freezer door.
- Check for blockages e.g. food containers, crisper cover, shelves, bins etc.

Limited Warranty

What is covered and for how long?

This warranty covers all defects in workmanship or materials for a period of:

12 months labor (carry-in-only)

12 months parts

5 years sealed system

The warranty commences on the date the item was purchased and the original purchase receipt must be presented to the authorized service center before warranty repairs are rendered.

EXCEPTIONS: Commercial or Rental Use warranty

90 days labor (carry-in only)

90 days parts

No other warranty applies

What is covered.

1. The mechanical and electrical parts, which serve as a functional, purpose of this appliance for a period of 12 months. This includes all parts except finish, and trim.
2. The components of the sealed system e.g. hermetic compressor, condenser and evaporator from manufacturing defects for a period of 5 years from the date of purchase. Any damages to such components caused by mechanical abuse or improper handling or shipping will not be covered.

What will be done?

1. We will repair or replace, at our discretion any mechanical or electrical part which proves to be defective in normal usage during the warranty period so specified.
2. There will be no charge to the purchaser for parts and labor on any covered items during the initial 12 month period. Beyond this period

only parts are covered in the remaining warranty. Labor is not provided and must be paid by the customer.

3. Contact your nearest authorized service center. For the name of the nearest service center please call 1-877-337-3639

THIS WARRANTY COVERS APPLIANCES WITHIN THE CONTINENTAL UNITED STATES, PUERTO RICO AND CANADA. IT DOES NOT COVER THE FOLLOWING

Damages from improper installation.
 Damages in shipping.
 Defects other than manufacturing.
 Damage from misuse, abuse, accident, alteration, lack of proper care and maintenance or incorrect current or voltage.
 Damage from other than household use.
 Damage from service by other than an authorized dealer or service center.
 Decorative trims or replaceable lightbulbs.
 Transportation and shipping.
 Labor (after the initial 12 months).

THIS LIMITED WARRANTY IS GIVEN IN LIEU OF ALL OTHER WARRANTIES, EXPRESSED OR, INCLUDING THE WARRANTIES OF MERCHANTABILITY AND FITNESS FOR A PARTICULAR PURPOSE

The remedy provided in this warranty is exclusive and is granted in lieu of all other remedies.

This warranty does not cover incidental or consequential damages, so the above limitations may not apply to you. Some States do not allow limitations on how long an implied warranty lasts, so the above limitations may not apply to you.

This warranty gives you specific legal rights, and you may have other rights, which vary, from state to state.

Haier America Trading L.L.C.
 New York, NY, 10018.

IMPORTANT

Do Not Return This Product To The Store

If you have a problem with this product, please contact the "Haier Customer Satisfaction Center" at 1-877-337-3639.

DATED PROOF OF PURCHASE REQUIRED FOR WARRANTY SERVICE

IMPORTANT

Ne pas Réexpédier ce Produit au Magasin

Pour tout problème concernant ce produit, veuillez contacter le service des consommateurs 'Haier Customer Satisfaction Center' au 1-877-337-3639.
UNE PREUVE D'ACHAT DATEE EST REQUISE POUR BENEFICIER DE LA GARANTIE.

IMPORTANTE

No regrese este producto a la tienda

Si tiene algún problema con este producto, por favor contacte el "Centro de Servicio al Consumidor de Haier" al 1-877-337-3639 (Válido solo en E.U.A).

NECESITA UNA PRUEBA DE COMPRA FECHADA PARA EL SERVICIO DE LA GARANTIA

115V, 60 Hz

Made in China
Fabriqué en Chine
Hecho en China

Haier[®]
What The World Comes Home To™

Haier America Trading, L.L.C.
New York, NY 10018

Printed in China

HDE03WNA
Issued: June 01

Part #:RF-9999-B6