

Haier

HRZ-60 BAR FRIDGE



USER'S INSTRUCTIONS

1.Name of parts

PARTS AND FEATURES

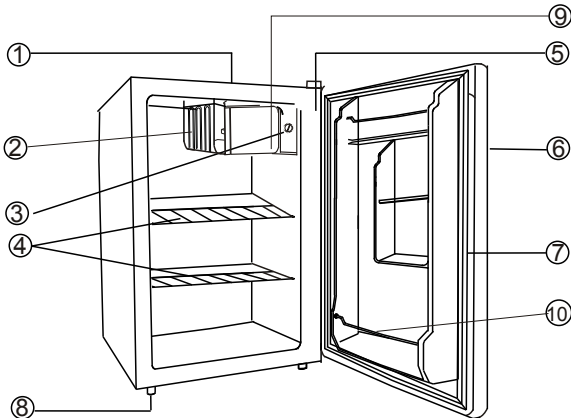

- ① Cabinet
- ② Cool Zone
- ③ Thermostat Knob (at the rear)
- ④ Shelf
- ⑤ Hinge Cover
- ⑥ Door
- ⑦ Gasket
- ⑧ Adjustable Foot
- ⑨ Cool Zone Door
- ⑩ Door Bar

2. Installation Instructions

Ventilating

To ensure adequate ventilation for your refrigerator see recommended cabinetry dimensions below. The refrigerator should be positioned 50mm from each wall, and have clear space 50mm above the top of the unit.

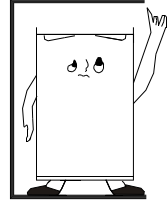

Power Supply

To ensure that the appliance is not accidentally switched off, connect your refrigerator to its own power point. Do not plug in any other appliance at this power point or use extension cords and double adaptors. Power requirements: 220-240VAC/50Hz. It is essential that the appliance be properly grounded (earthed).

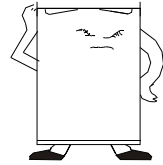

Power Line Cord

Never unplug your refrigerator by pulling on the power cord. Always grip the plug firmly and pull straight out from the outlet. Repair or replace immediately all electric service cords that have become frayed or otherwise damaged. Do not use a cord that shows cracks or abrasion along its length or at either the plug or appliance end.

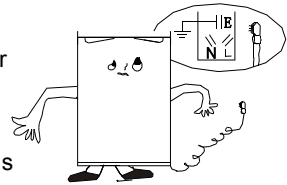

Protection from Moisture

Avoid installing this refrigerator in a place where heavy moisture is present, or where it may be directly sprayed with water. Exposure to excessive moisture can create an electrical hazard.



2. Installation Instructions

Protection From Heat

Your refrigerator should not be located in direct sunlight or next to any heat generating appliance such as a cooktop, oven or dishwasher.



Positioning

Only install this refrigerator on a stable, flat floor and should it not be laid on soft materials such as foam, plastic. Ensure the unit is stable by adjusting the front feet.

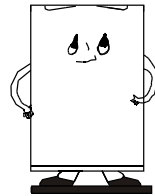

Environment

Do not install this refrigerator near flammable, combustible or explosive materials. Never store volatile or flammable materials in your refrigerator as they may explode.

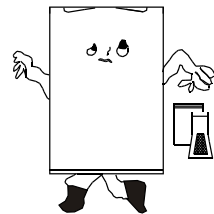

Moving

When fixed or moved, the refrigerator can not be set horizontally or inclined more than 45° or upside-down.

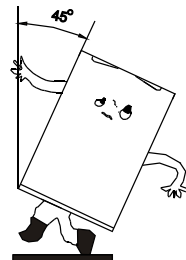

3. Safety & Warnings

- ★ Ensure the voltage in the power socket is the same as the rated voltage of this appliance.
- ★ Water and condensation may gather inside the refrigerator cabinet, and form a layer of frost. This will be evaporated during the defrost cycle and will be collected in the drain pan above the compressor.
- ★ If the power supply cord is damaged, it must only be replaced by your Haier Appliances Authorised Repairer because special purpose tools are required.
- ★ It is dangerous to alter the specifications or attempt to modify this product in any way
- ★ When storing your cleaned appliance, leave the doors open. This allows air to circulate and prevents the build up of bacteria and moulds. Before using again, clean well using a mixture of warm water and baking soda (add 1 teaspoon of baking soda to each 500 ml of water). Rinse with clean water.
We recommend you leave your refrigerator operating while you are on holiday.
- ★ If your refrigerator is turned off for any reason, wait 10 minutes before turning it back on. This will allow the refrigeration system pressures to equalise before restarting.

4.Changing the reversible door

This refrigerator has the capability of either opening the door from the left or right side. The unit is delivered to you with the door opening from the left side. Should you desire to reverse the opening direction, please follow these instructions.

NOTE:

Before Reversing the door ,the power must be shut off.

All parts removed must be saved to do the reinstallation of the door.

This refrigerator has been built with the door hinges on the right. If you wish to change the opening direction, follow the instructions below:

1. Remove the upper hinge cover(6) first
2. Remove the two screws (1) that hold the upper hinge (5) (right side) to the frame. Take away the upper hinge (5).
- 3.Lift the door and place it on a padded surface to prevent scratching it.
4. Remove the two screws(8) that hold the lower hinge(2) and Make sure to Remove the lower hinge(2).
5. Remove the left front leg (4) and transfer it to the right side.
6. Remove the hole cover plate(7) to the right side.
7. Before placing this lower hinge(2), remove the bolt-pin (9) and reverse the direction of the lower hinge(2). Then install the lower hinge (2) onto the left side of the lower frame with two screws (8).
8. Insert the bolt-pin(9) to the lower hinge (2).
9. Set the door to its place making sure the door seat at the lower hinge(2)
10. While holding the door in the closed position secure the upper hinge (5) in the top frame of left side with two screws (1). Please remember that do not tighten the two screws(1) until the top of the door is levelled with the counter top.
11. Install the upper hinge cover(6) on the upper hinge..

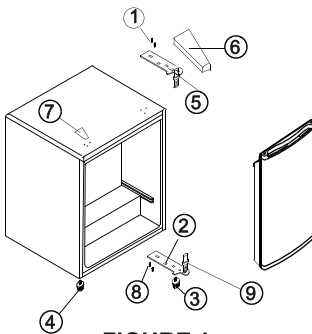

FIGURE 1

Door opening from left side

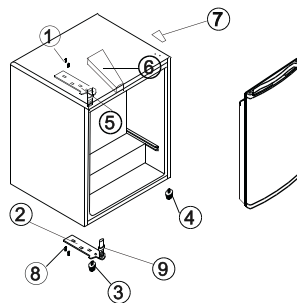

FIGURE 2

Door opening from right side

5.Maintenance

- ★ The refrigerator should be cleaned and maintained once a month.
- ★ When moving or cleaning, make absolutely sure that the power plug is first disconnected from the power outlet.
- ★ Wipe the inner and outer surface of the refrigerator and its accessories with a damp cloth. If heavily soiled, gently clean with neutral detergent, wipe with a clean damp cloth and allow to dry.
- ★ Do not use hot water, petrol, alcohol, kerosene, washing powder, cleanser, acid, Chemical cloth, etc when cleaning this appliance. Do not spray the cabinet with water, as this may cause an electrical hazard or cause the outer cabinet to rust.
- ★ Clean the door seals regularly to ensure the door closes correctly, and that your appliance functions efficiently.
- ★ When storing your cleaned appliance, leave the doors open. This allows air to circulate and prevents odours. Ensure shelves are cleaned if foods or liquids are spilled to avoid damage.

6. Troubleshooting

1. When the refrigerator does not work
 - Check if there is a power failure.
 - Check if the power plug is plugged into the power outlet.
 - Check that the fuse has not blown.
2. When the refrigerator is cooling excessively
 - The temperature control dial may be set too high.
 - If you place foodstuffs containing a lot of moisture directly under the cool air outlets, they will freeze easily. This does not indicate a malfunction.
3. When the refrigerator is not cooling sufficiently
 - The food may be packed too tightly together which will block the flow of cool air.
 - You may have put something hot or large objects into the refrigerator .
 - The door may not have been closed properly.
 - The door gaskets may be damaged.
 - The refrigerator may not be ventilated correctly.
 - There may be insufficient clearance between the refrigerator and the surfaces immediately both sides and above.
 - The temperature control dial may not be set properly.
4. If defrosting water overflows inside the refrigerator and onto the floor.
 - Check that the drain pipe and the drain hose are not clogged.
 - Check that the drain pan is housed properly.
5. When condensation forms on the outside of the refrigerator.
 - Condensation may form on the outside when the humidity is high wipe dry with a dry cloth.
6. When you hear a sound like water flowing .
 - A sound like water flowing is the refrigerant flowing. It does not indicate a malfunction.
7. When the cabinet's side panel heats up
 - The side panel of the cabinet will heat up when the door is opened or closed frequently, when starting the unit and when the unit operates in summer with high ambient outside temperature, In such cases, do not touch the panel, it results from the dissipation of the heat from inside the cabinet, and it does not mean that something is wrong with the refrigerator.

7. Technical specifications

- For detailed technical specifications, please refer to the name plate at the back of the refrigerator..
- Specifications are subject to change without prior notice.

Warnings

- * This appliance is not intended for use by persons (including children) with reduced physical, sensory or mental capabilities, or lack of experience and knowledge, unless they have been given supervision or instruction concerning use of the appliance by a person responsible for their safety.
- * Children should be supervised to ensure that they do not play with the appliance. If the supply cord is damaged, it must be replaced by the manufacturer, its service agent or similarly qualified persons in order to avoid a hazard.
- * Keep ventilation openings, in the appliance enclosure or in the built-in structure, clear of obstruction.
- * Do not use mechanical devices or other means to accelerate the defrosting process, other than those recommended by the manufacturer.
- * Do not damage the refrigerant circuit
- * Do not use electrical appliances inside the food storage compartments of the appliance, unless they are of the type recommended by the manufacturer.

IMPORTANT DISPOSAL INSTRUCTIONS



As a responsible retailer we care about the environment.

As such we urge you to follow the correct disposal procedure for your product and packaging materials, This will help conserve natural resources and ensure that it is recycled in a manner that protects health and the environment.

You must dispose of this product and its packaging according to local laws and regulations. Because this product contains electronic components and sometimes batteries, the product and its accessories must be disposed of separately from household waste when the product reaches its end of life.

Contact your local authority to learn about disposal and recycling.

The product should be taken to your local collection point for recycling.

We apologise for any inconvenience caused by minor inconsistencies in these instructions, which may occur as a result of product improvement and development.

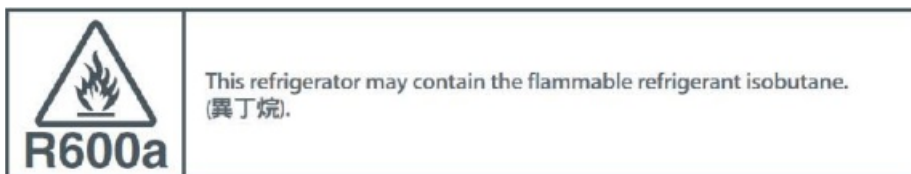

R600a REFRIGERANT

This appliance may contain a small quantity of environmentally friendly, but flammable , non-synthetic R600a refrigerant:

- Upon opening and installing your product, check that the tubing of the refrigerant circuit is not damaged during transportation.
- Leaking refrigerant may cause eye injuries or ignite.
- The room for installing appliance must be at least 1m per 8g of refrigerant. The amount of refrigerant in the appliance can be found on the rating plate the back of the unit.
- Keep ventilation openings in the appliance enclosure or in the built-in structure clear of obstruction.
- Do not damage the refrigeration circuit.

If your are unsure of the refrigerant type check the rating plate on the back of the unit.

