

# Haier

HR-126WL

Refrigerator

Operation Instructions

## Contents

Cautions -----	1-2
Parts -----	3
Observations -----	4
Basic Operation -----	5
Operation Instructions -----	6
Defrosting/Cleaning -----	7-8
Troubleshooting -----	9

## *Cautions*

### ***Disposal of the old appliance***

Before disposing an old appliance that goes out of use, please make sure it's inoperative and safe. Unplug the appliance and remove or destroy all of the springs, latches, or boltlocks in order to avoid the risk of child entrapment.

It must be noticed that refrigeration system contains insulating gases and refrigerants, which require specialized waste disposal. The valuable materials contained in a refrigerator can be recycled. Contact your local waste disposal center for proper disposal of an old appliance and contact your local authority or your dealer if you have any question. Please ensure that the pipework of your refrigerator does not get damaged prior to being picked up by the relevant waste disposal center, and contribute to environmental awareness by insisting on an appropriate, anti-pollution method of disposal.

### ***Disposal of the packaging of your new appliance***

All the packaging materials employed in the package of your new appliance may be disposed without any danger to the environment.

The cardboard box may be broken or cut into smaller pieces and given to a waste paper disposal service. The wrapping foil is made of polyethylene and the polyethylene pads and stuffing contain no fluorochloric hydrocarbon.

All these valuable materials may be taken to a waste collecting center and used again after adequate recycling.

Consult your local authorities for the name and address of the waste materials collecting centers and waste paper disposal services nearest to your house.

### ***Safety Instructions and Warnings***

Before starting the appliance, read the information given in the User's Guide carefully. The User's Guide contains very important observations relating to the assembly, operation and maintenance of the appliance.

Keep the User's Guide in a safe place and remember to hand it over to the subsequent owner, if you ever sell the appliance.

The manufacturer does not accept responsibility for any damages that may arise due to non-observation of the following instruction.

- Damaged appliances are not to be put into operation. In case of doubt, consult your supplier.
- Connection and installation of the appliance are to be carried out in strict compliance with the relative instructions set forth in the User's Guide.

## *Cautions*

● For the purpose of safety, the appliance must be properly grounded in accordance with specifications.

● Always remember to unplug the appliance before cleaning. Never unplug your refrigerator by pulling on the power cord. Always grip plug firmly and pull straight out from the outlet.

● All electrical repairs must be carried out by qualified electricians. Inadequate repairs may result in a major source of danger for the user of the appliance.

● Keep high-proof beverages in airtight bottles or containers and always store in an upright position. In addition, do not store any explosive substances inside the appliance-  
**Danger of explosion!**

● Do not damage any parts of the appliance that carry refrigerant by piercing or perforating the refrigerant's grooves with sharp or pointed items, crushing or twisting any tubes, or scraping the coatings off the surfaces. If the refrigerant spurts out and gets into eyes, it may result in serious eye injuries.

● Do not obstruct or cover the ventilation grille of the appliance.

● Do not allow children to play with the appliance. In no case should children be allowed to sit on the drawers or hang to the door.

● If the supply cord is damaged, it must be replaced by the manufacturer or its service agent or a similarly qualified person in order to avoid a hazard.

## **Specifications**

● This appliance is designed for food refrigeration, making ice.

● It is intended strictly for household use. If using it for industrial or commercial purpose, be sure to observe the relevant norms and regulations.

● The refrigerating circuit is leak-proof.

### **WARNING**

The plug should be accessible after the appliance positioned.

## Parts

---

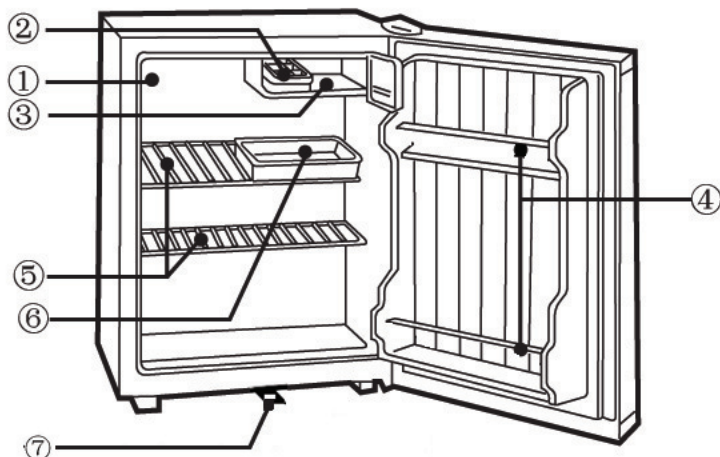

- |                          |             |               |
|--------------------------|-------------|---------------|
| 1. Temperature regulator | 2. Ice tray | 3. Evaporator |
| 4. Bottle rack           | 5. Shelf    | 6. Water tray |
| 7. Lock                  |             |               |

*The manufacturer reserves the right to improve the product from time to time without further notice.*

## Observations

---

- The appliance can be placed with its rear panel directly against the wall.

For a good air circulation, the vent grille at the back of the worktop must not be blocked, It should be placed on flat and firm ground lest it gives off higher noise than usual.

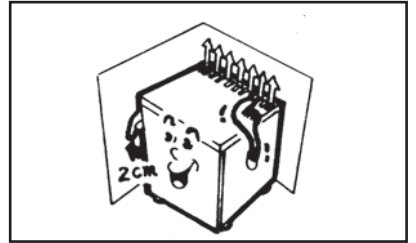

- Do not expose the appliance to direct sunlight or a heat source as cookers, radiators, heaters, etc.

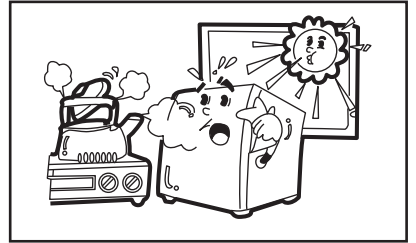

- Allow warm foods or beverages to cool down before placing them into the appliance.

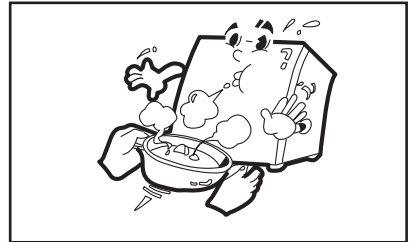

- Do not open the door more often than necessary to lessen cold air escape.

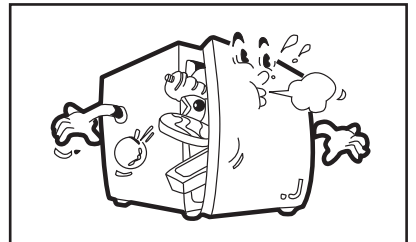

- For adequate air circulation, do not overfill the refrigerator.

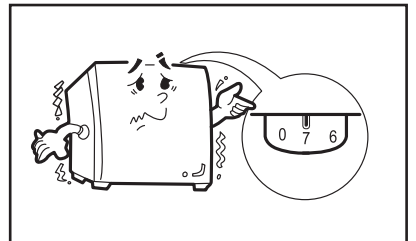

- Adjust the temperature regulator in accordance with the ambient temperature and the amount of foods.

## Basic Operation

### **The appliance must stand on even flooring.**

If the appliance is to be placed on a soft carpet, support the appliance with a solid wood board. If the appliance is placed on the carpet directly, the high-temperature compressor may cause color fading of the carpet.

- A separate earthed three-pole is required. Stop using the appliance if a sensation of electric shock is felt when touching the refrigerator.

- The appliance must be properly earthed, especially in a place of thick moisture.

1. Clean the inner compartment.
2. A special socket is required.
3. After 2 or 3 hours of non-load operation, the inner compartment is cold enough and suitable for food storage.

### **Tips for refrigeration**

#### **Temperature selection**

Adjust the inner temperature in accordance with the ambient temperature and the amount of foods to be refrigerated.

#### **Application**

- 1-2 Summer, ambient temperature 25°C-35°C.
- 2-4 Spring and autumn, ambient temperature 15°C-25°C.
- 4-5 Winter, ambient temperature 5°C-15°C.
- 6-7 Fast refrigeration and making ice. After that, reset the temperature to a normal setting. Otherwise, the foods in the refrigerator may be frozen.

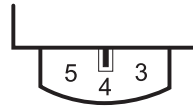

**Note: Foods** in the refrigeration compartment may get frozen in following cases,

- The temperature regulator is set at a higher figure than necessary. If so, reset the temperature regulator to a proper setting.
- In winter, ambient temperature is lower than 5°C.

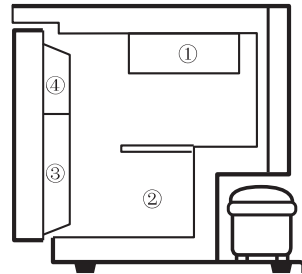

#### **Temperature difference**

The inner temperature varies at different parts of the inner compartment. The coldest part is part 1, and the temperature gets warmer in turn of part 2, 3 and 4.

## Operation Instructions

● Do not store frozen foods and ice creams in the refrigerator-Danger of thawing!

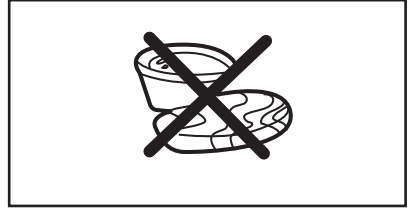

● Wrap or cover foods well before storing so as to avoid loss of water content and off-odor.

● The appliance can not be used to store medicine or scientific specimen.

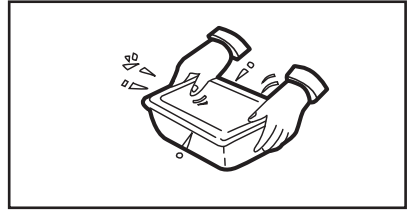

● Do not place heavy items more than 20kg on the top of the refrigerator.

● Do not place water container, vase or other items that are likely to fall when the door is opened.

● Do not place bottles of beverage in the evaporator-Danger of explosion.

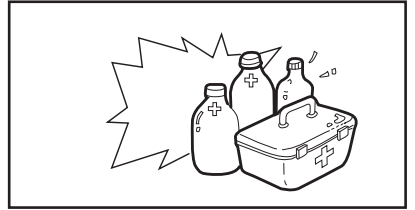

● Keep off the cold surfaces of the evaporator, especially when hands are wet, hands may be frozen to the extremely cold surfaces.

● After the appliance is unplugged, do not plug in again until 3 minutes later.

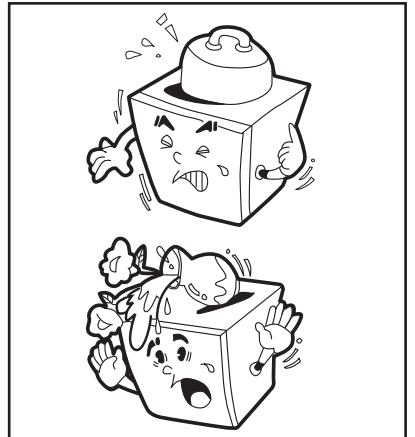

## When not in use

● Unplug the appliance

● Clean and dry the inner compartment. Open the door for 2 or 3 days to dry the inner compartment thoroughly.

● A refrigerator that is set out of use without cleaning may suffer from unpleasant odors or mildew.

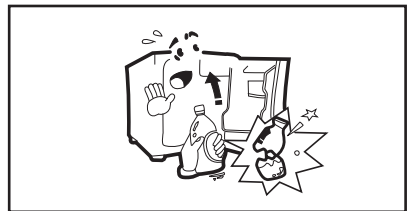

## Defrosting/Cleaning

---

### Defrosting

● The surface of evaporator ices up when the refrigerator is working. When the frost layer is thick as 3mm, the refrigerator must be defrosted and cleaned. Otherwise, it may result in lower efficiency and high energy consumption.

1. Take out foods and ice tray. Keep the door open.
2. Set the temperature at '0' position. After defrosting, dry the water tray and then replace it in the refrigerator. Reset the temperature regulator to its original position.

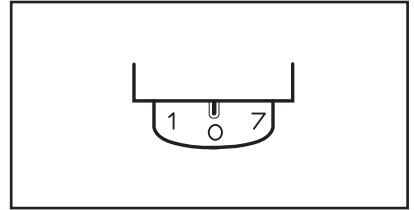

**Note:** Never use a sharp or pointed item to defrost or loose the ice tray. Otherwise it's likely to damage the surfaces of the evaporator and result in the leakage of refrigerant. The manufacturer takes no responsibility for cost of the reparation even the appliance is under guarantee.

### Making ice

- Fill the 3/4 ice tray with water and then place it in the lower part of the evaporator.
- Set the temperature regulator at '7'.
- After making ice, reset the temperature regulator to its original position. Otherwise foods may get frozen.

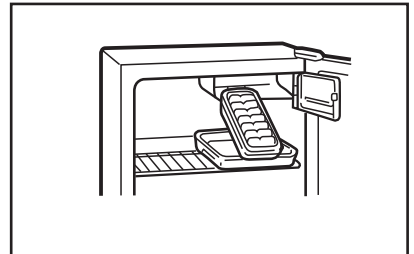

### To take out the ice cubes

1. Knock the ice tray lightly to loose it.
2. Hold the bottom of the ice tray in warm water for a while.
3. Twist the ice tray to loose the ice cubes.

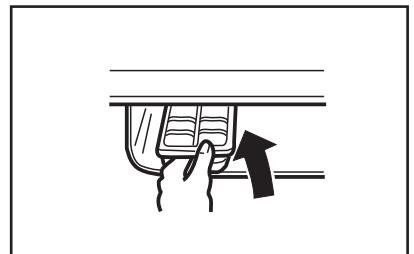



## Defrosting/Cleaning

---

### Cleaning

1. Unplug the appliance.
2. Wash the inner compartment with lukewarm water and neutral detergent.
3. Dry the surface of the refrigerator thoroughly.

Note:

1. Avoid splashing water on the freezer when cleaning.
2. Do not use cleansers such as soaps, paint, boiled water or acid, etc.
3. When using a chemical rag, do not scratch the inner surfaces hardly.

- For efficient operation, dirt and dust should be removed from back and bottom of your freezer from time to time.

- To clean the door seal, use mild, soapy water only.

### Moving the refrigerator

- Unplug the appliance
- Take out foods and dry the water tray before moving the refrigerator.

**Note:** Do not hold the refrigerator by its door and the piping of condensor-That's dangerous!

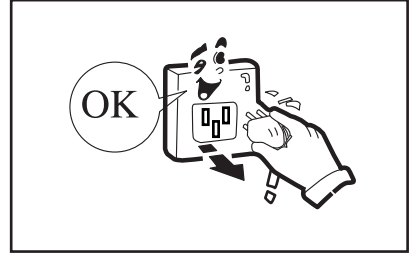

### When a power failure is announced

- No defrosting
- Set the temperature regulator to the highest figure.
- No more fresh foods are to be stored in the refrigerator.

### Power failure

- Do not open the door more often than necessary.
- For a power failure not more than 3 hours, foods in the refrigerator can be well stored even in summer.

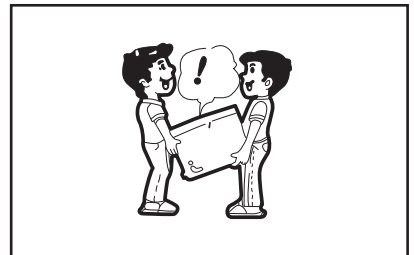

## *Troubleshooting*

***Before calling the service center, check the following points and see if you can solve the problem yourself.***

Problem	Possible Causes
No refrigeration	<ul style="list-style-type: none"><li>● Electrical connection is loose.</li><li>● Fuse is broken.</li></ul>
The inner Temperature is not cold enough.	<ul style="list-style-type: none"><li>● Wrong temperature selection.</li><li>● The inner compartment is overfilled.</li><li>● The appliance is exposed to direct sunlight or a heat source, such as heater.</li><li>● Frequent door opens.</li></ul>
Unusual noises	<ul style="list-style-type: none"><li>● The appliance doesn't stand level.</li><li>● Some part of the refrigerator rubs against the wall or other furniture.</li><li>● It's normal that the noise of flowing refrigerant can be heard during the interval of the stop and restart of the compressor.</li></ul>
The outer surfaces are wet.	<ul style="list-style-type: none"><li>● Rain season of high humidity. If so, dry the surfaces thoroughly.</li></ul>
The inner surfaces are wet.	<ul style="list-style-type: none"><li>● The door is frequently opened or it's kept open too long.</li><li>● There are large amount of foods of high water content stored in the refrigerator. Dry the inner compartment thoroughly.</li></ul>