

Ice-lined Refrigerator

Haier

HBC-70/200

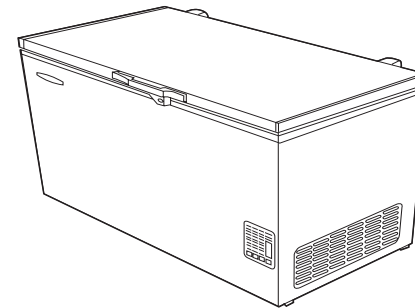

Operation Manual

- Please read this operation manual carefully before using the appliance.
- Keep this manual in a safe place.
- Appearance, color and layout of the door may vary.
- This refrigerator with freezing lining is designed for storage of vaccines.

Contents	
PRIMARY FEATURES	1
PARTS IDENTIFICATION	2
BASIC SAFETY TIPS.....	3
INSTALLATION	4
Location & Clearances	
Proper Grounding	
Use Of An Extension Cord	
Electrical Notes	
OPEARATION	5
Temperature Control	
Cool down of the refrigerator	
LOADING THE REFRIGERATOR.....	6
Starting Procedure	
Temperature Control	
Loading Vaccines	
Temperature Indication	
Wire-basket	
CLEANING & CARE.....	7
Inside	
Outside	
GOING ON VACATION	8
MOVING	9
QUICK SERVICE CHECKLIST.....	10
Technical data & Electric diagram IBC	



0070507563

Primary features

1、 Temperature stability

24hours after the refrigerator is initiated, the temperature inside the refrigerator will be kept between 2°C and 8°C even if the power supply is interrupted for 20 hours (not less than 8 hours between every 2 power failures) at ambient temperature of 43°C.

2、 Temperature indicator

Temperature inside the refrigerator is displayed by the indicator.

3、 Excellent cooling system performance

Danfoss compressor is used for ensuring a long-term reliable performance of the cooling system .

4、 Stainless steel inner liner

5、 Drainage

If the refrigerator has been accumulated too much water, we can use the defrosting drainpipe to drain out the water.

6、 Use advanced manostat to ensure the refrigerator safety using in the indian environment.

Notice

The unit can be stored continuously in ambient temperature of 0°C~50°C and relative humidity of 15%~90%.

The unit can work under ambient temperature of 5°C~45°C and relative humidity of 15%~90%.For better unit performance and situation,we suggest that the unit work under ambient temperature 10°C~43°C and relative humidity of 15%~90%.

ATTENTION

The ILR should be used as following steps:

(1) Settle the trays and baskets strictly according to the pic1 and pic2.

Notice: Please locate two trays on the plain stage of the HBC-70 in the opposite direction.

(2) Running ILR for 24hours later and make sure the inner cabinet temperature between 2 to 4°C by adjusting temperature controller if needed.

(3) The vaccines should be stored inside baskets. The trays above the basket should be used during vaccine storage. There should be some distance between vaccines for vaccines safety. Vaccines should be stored with one third of the capacity of the ILR per time and total vaccines should be loaded by steps.

(4) Make sure the door closed completely.

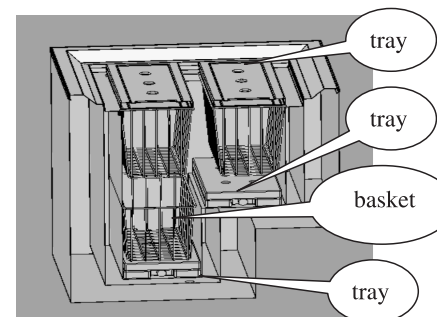

fig 1 (HBC-70)

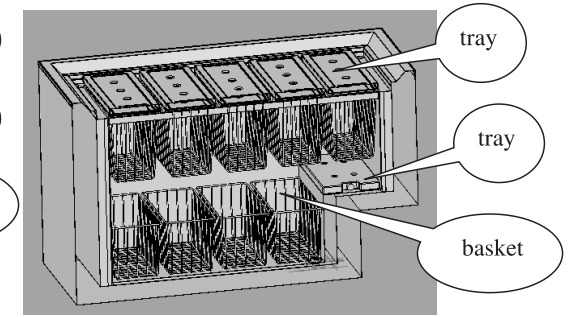

fig 2 (HBC-200)

MAIN TECHNICAL DATA

Model	Effective volume (l)	Power (V/Hz)	Power input (W)	Power consumption kw.h/24h	Anti-shock safety classification	Net weight (kg)	Size LXWXH (mm)	Refrigerant R134a (g)	Climate classification
HBC-70	70	220-240/50	150	1.0	I	64	670X630X820	110	T
HBC-200	200	220-240/50	194	1.6	I	108	1240X630X820	185	T

CIRCUIT DIAGRAM

HBC-200 Circuit Diagram

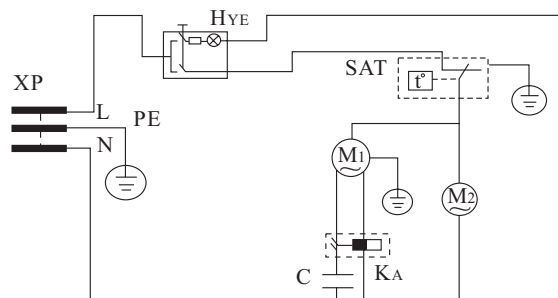

XP- plug SAT-Thermostate
 KA-starter HYE-Yellow switch lamp
 M1-Compressor C-Capacitor
 M2-Cooling fan

HBC-70 Circuit Diagram

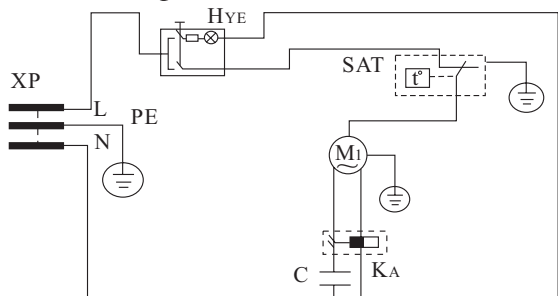

XP- plug SAT-Thermostate
 KA-starter HYE-Yellow switch lamp
 M1-Compressor C-Capacitor

Parts Identification

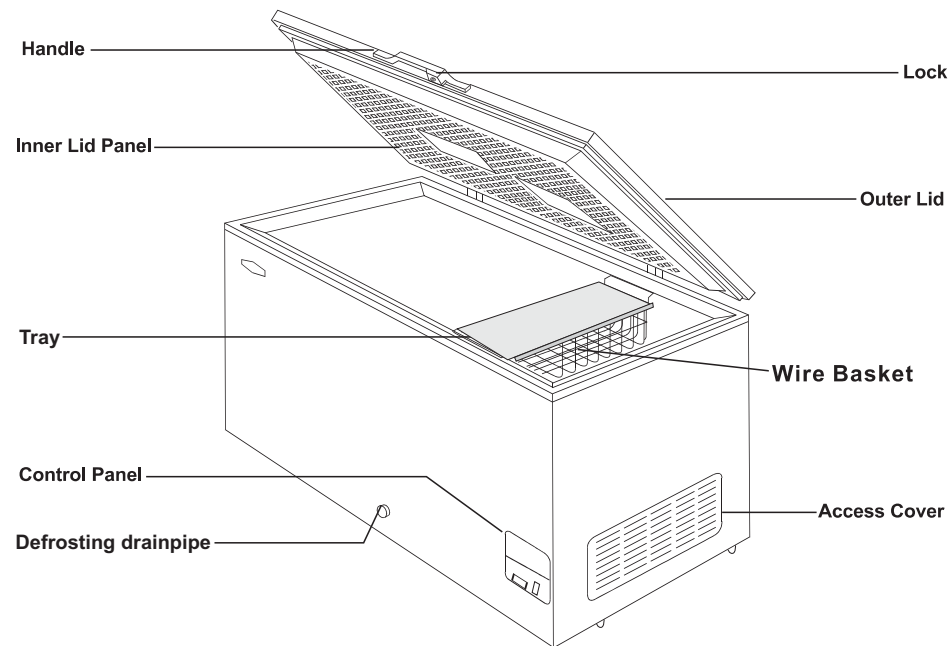

INTERIOR LID PANEL - designed to keep icicles from cabinet.

HANDLE - comfortable grip with lock.

WIRE BASKET AND TRAY - carries out easily even when fully loaded and keeps temperature stabilization.

ACCESS COVER - for easy servicing.

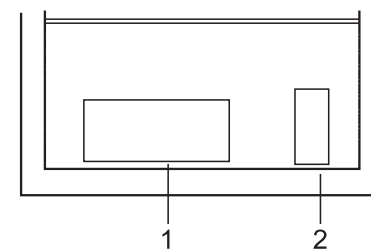

CONTROL PANEL:

1. TEMPERATURE MICROPROCESSOR THERMOSTAT - regulates and indicates the temperature of the refrigerator.
2. POWER SWITCH and INDICATOR LAMP - lights up when refrigerator is operating.

In case the product is improved, please find the renewed technical data and the circuit diagram at the back of the refrigerator.

Basic Safety Tips

Follow the instructions and installation requirements in this Use and Care Guide.

Use your refrigerator only for the purpose it is intended.

Do not allow children to play, climb, stand or hang on the shelves of your refrigerator.

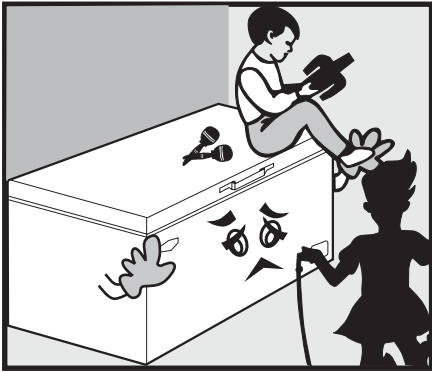

Always unplug your refrigerator before:

- cleaning
- making any repairs

To unplug your refrigerator, grip plug firmly and pull straight out from the outlet. **Do not jerk or pull on the power cord.**

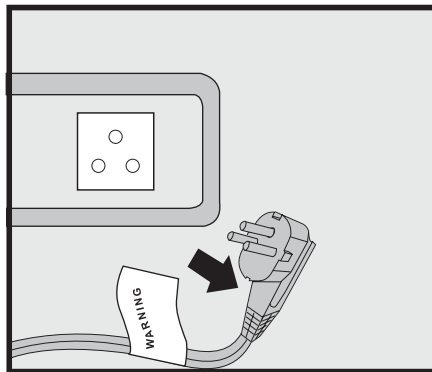

Be careful not to damage the power cord by rolling the refrigerator over it or loosening joints by pulling or jerking on the cord. **Have any damaged power cord immediately replaced by a qualified serviceman** to avoid any electrical hazards.

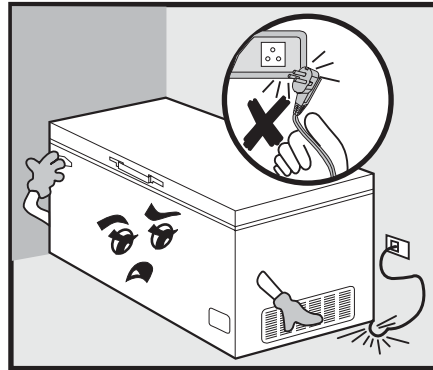

● IMPORTANT

If the supply cord is damaged, it must be replaced by the manufacturer or its service agent or a similarly qualified person in order to avoid a hazard.

Moisture forms outside refrigerator.

■ High humidity.

■ This is normal. Dry surface with soft, clean cloth.

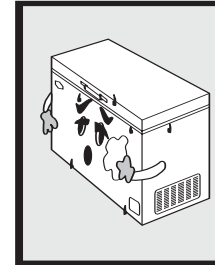

Refrigerator exterior is warm and compressor is hot enough to burn you.

■ Normal refrigerator operation.

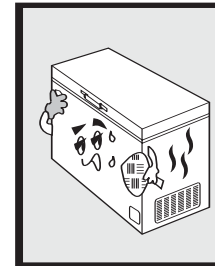

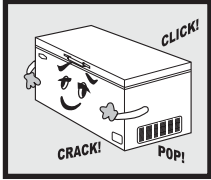
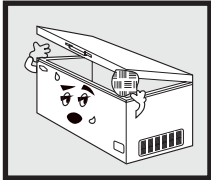
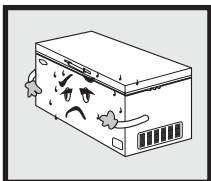
PROBLEM	POSSIBLE CAUSE	WHAT TO DO
Refrigerator is noisy. 	<ul style="list-style-type: none"> Refrigerant flowing in the system. Temperature control clicking ON or OFF. Cracking or popping of cooling coils caused by expansion and contraction during defrosting and restarting the unit after defrosting. 	<ul style="list-style-type: none"> These are sounds normally heard during the operation of your refrigerator.
Refrigerator compartment temperature is too warm. 	<ul style="list-style-type: none"> Temperature control is not set cold enough. Warm weather. Frequent opening or lid was left open. 	<ul style="list-style-type: none"> Refer to the Temperature Control Instructions in this Use and Care Guide. Refrain from unnecessary opening of refrigerator. Check that the lid is firmly closed.
Lid won't close. 	<ul style="list-style-type: none"> Lid is misaligned. A package that may be holding the lid open. 	<ul style="list-style-type: none"> Check hinge for lid misalignment. Store properly.

Installation

LOCATION & CLEARANCES

The refrigerator is designed for free-standing installation only. It should not be recessed or built-in.

Make sure there is ample clearance around your refrigerator for proper air circulation and ease in installation and maintenance.

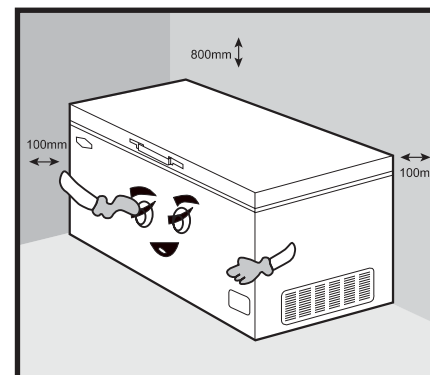

Install the refrigerator in a well-ventilated area, away from direct sunlight and any other heat sources like stoves, ovens and exhaust vents. Air must circulate freely around the refrigerator.

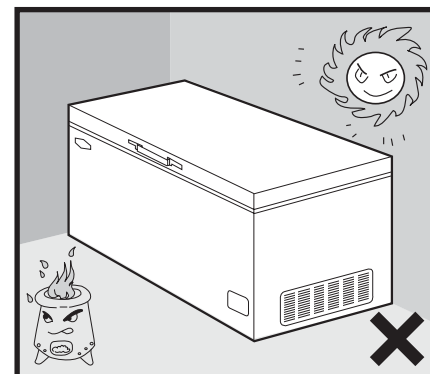

PROPER GROUNDING

Important for personal safety, this appliance must be properly ground.

In the event of an electric short circuit, grounding reduces the risk of electric shock by providing an escape wire or the electric current. This appliance is equipped with a cord having a grounding wire with a grounding plug. The plug must be plugged into an outlet that is properly installed and grounded.

Consult a qualified electrician or service center if the grounding instructions are not completely understood, or if doubt exists as to whether the appliance is properly grounded.

Do not, under any circumstances, cut or remove the third (ground) prong from the power cord.

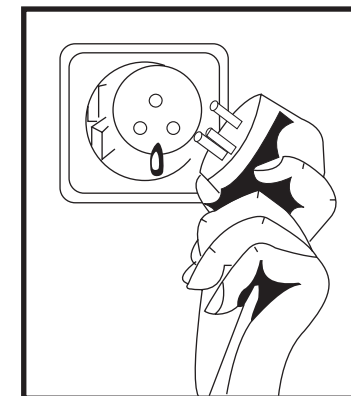

- Make sure the refrigerator is on a stable surface to avoid noise and vibration.

USE OF A STABILIZER

In order to make the freezer running steadily, it must be connected with a special stabilizer, and then connect the stabilizer on -to the power supply. Then put on the power switch, the yellow lamp will be lightened to indicate power on.

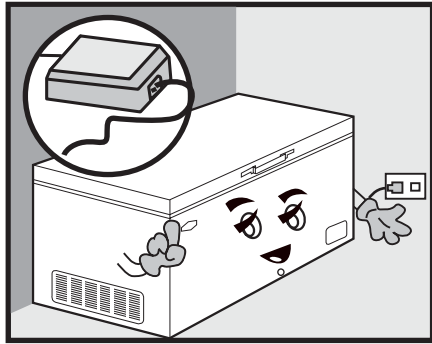

ELECTRICAL NOTES

Always plug your refrigerator into its own individual electrical outlet (220Volts / 50Hertz, single phase AC). This is recommended to optimize the unit's performance and to prevent overloading of electrical wiring circuits, which in turn could cause fire hazards.

The product warranty provisions do not cover defects resulting from operating your unit outside this indicated normal voltage range.

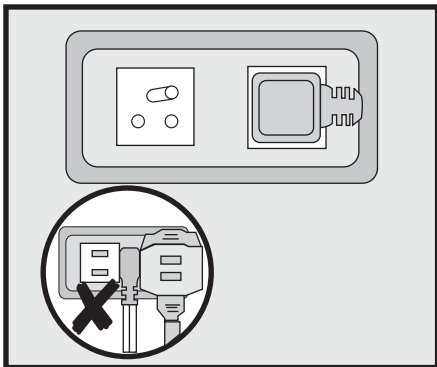

Operation

Temperature control

The refrigerator has a thermostat that control the temperature in the vaccine compartment. We can set the temperature from 2°C to 8°C by using the key "△" or "▽".

The yellow lamp is on when the refrigerator is connected to the power supply.

Cool down of the refrigerator

Before the refrigerator is loaded with vaccines the ice-lining in the 4 sides must be frozen.

To ensure that the ice-lining in the 4 sides is frozen do the following:

1. Set the external thermostat at 3°C
2. Check the temperature in the thermometer (must be between 2°C-5°C)

The temperature in the vaccine compartment must always be monitored on the thermometer and be within the range 2°C to 8°C

Due to tolerance of the thermostat you should always set the temperature from 2°C to 5°C.

Please make sure that the inner-lid should be covered inside cabinet.

DEFROSTING

Too much frost inside the freezer hampers the cooling efficiency of your unit. When frost on the freezer walls is over 6 to 8 mm thickness your freezer needs to be defrosted.

Simply follow this easy defrosting procedure:

- To defrost, first turn off the switch for about 4 hours. This will harden items which you may want to keep in freezer later.
- Unplug your freezer from the electrical outlet.
- Empty all foodstuffs from your freezer.
- To defrost faster, keep the door open and place a bowl of warm water in the freezer allow frost to melt.

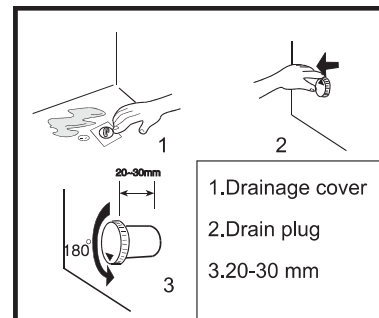

Quick Service Checklist

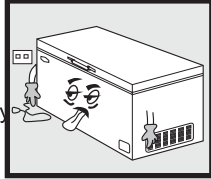
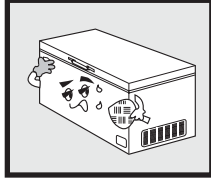
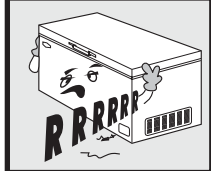
PROBLEM	POSSIBLE CAUSE	WHAT TO DO
Refrigerator is not working. 	<ul style="list-style-type: none"> ■ Power cord has been removed or loosened from the electrical wall outlet. ■ House fuse has been blown-out or circuit breaker has tripped. 	<ul style="list-style-type: none"> ■ Plug the power cord properly into its electrical wall outlet. ■ Replace blown-out fuse or reset tripped circuit breaker.
Motor stops and starts frequently. 	<ul style="list-style-type: none"> ■ The temperature control stops and starts the motor to maintain even temperatures. 	<ul style="list-style-type: none"> ■ These sounds are normal while your refrigerator is in operation.
Vibrating or rattling sounds. 	<ul style="list-style-type: none"> ■ Refrigerator may now be resting solidly on the floor or the floor is weak or uneven. 	<ul style="list-style-type: none"> ■ Move the refrigerator so that it is positioned solidly on a strong, even floor.

Moving

Before moving your refrigerator:

- Take out all.
- Cut off the power and unplug your refrigerator.

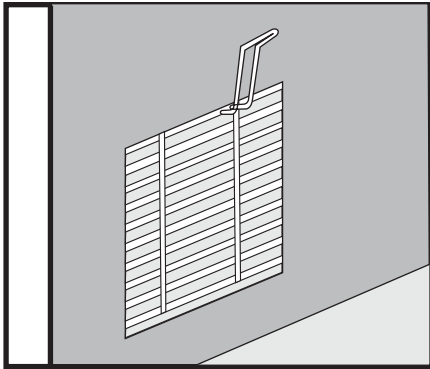

- Loop the power cord position safely to avoid damaging the cord during the move.
- Clean and dry the inside of your refrigerator.

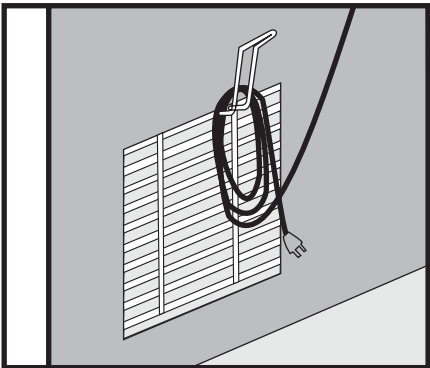

- Ensure all catchable and moveable Parts inside the refrigerator.
- Always keep your refrigerator in its upright position while moving and during transport.

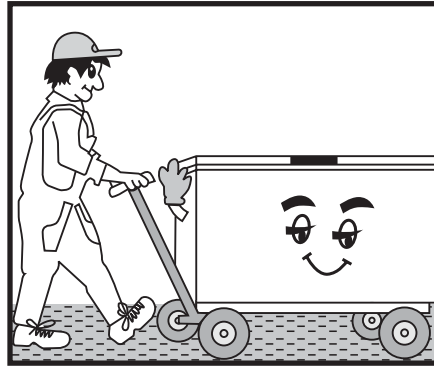

Keep your refrigerator secured during transport to prevent unnecessary movement. Cover your refrigerator with a blanket to protect the paint finish from scratches.

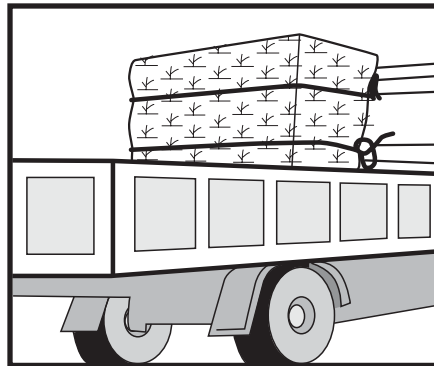

For reinstallation, please refer to the Installation Procedures of this Use and Care Guide.

Start the refrigerator

Starting procedure

Connecting the mains lead to the power supply. The yellow lamp must be lighted to indicate that the refrigerator is under operating. The thermostat is adjusted to be between 2°C-5°C. Keep this position at least 24 hours.

Temperature control

After 24 hours' operation thermostat setting should be adjusted to 3°C the inside temperature must be between 2°C and 5°C. The inside and temperature must be checked regularly according to WHO's standards and specification.

Loading vaccines

When the temperature in the vaccines compartment is stable, i.e. the temperature is between 2°C and 5°C and the compressor has normal stop and start, vaccines can be loaded.

Temperature thermostat

The refrigerator has a temperature thermostat displaying the temperature inside. (Display temperature is measured at one point on the top of the refrigerator.) The digital indicator has a cell. Service life of the cell is 20 hours when the power is off.

Temperature thermostat set



Pressing the keys of 'Fn' and 'SET' at the same time, then press 'SET' key for 2 or 3 seconds. Adjust the temperature by '△' or '▽' when ice is in 'SET'.

Introduction of the displayer

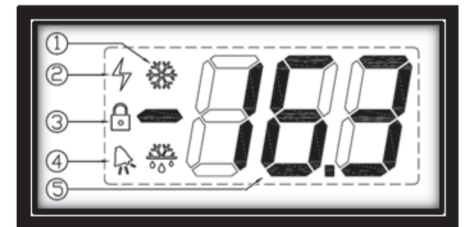

1. when the compressor is working, ① will be visual.
2. when the power is connected, ② will be visual.
3. when the displayer is locked, ③ will be visual.
4. when it is on alarm, ④ will be audiovisual.
5. The number of the temperature. If the number is different from the temperature testing by another thermometer, it is a natural thing. Because the sensors are placed at different areas.

Cleaning and Care

WIRE BASKET AND TRAY

The refrigerator has some removable wire baskets and some trays for storing items. Which help vaccines to avoid some abnormal temperature region.

Please keep to use them inside anytime.

Clean your refrigerator regularly. Refrigerator should be cleaned at least once every one to two weeks.
Unplug your refrigerator before cleaning.

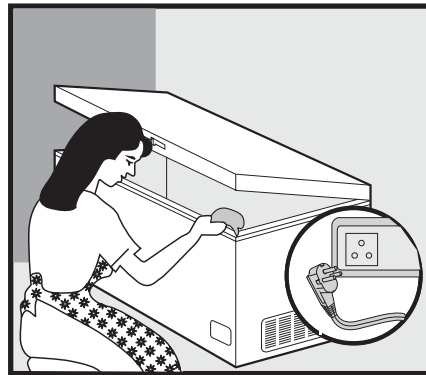

INSIDE

Remove wire baskets and wash them in a solution of warm water and baking soda. Rinse well in clean water and wipe dry.

Use 1 tablespoon of baking soda for every 1 liter of water.

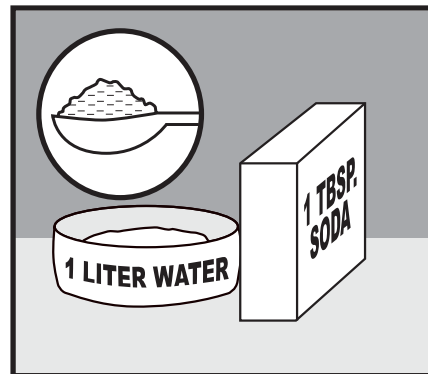

To clean the interior of your refrigerator compartment, use a piece of soft, clean cloth dampened in lukewarm water mixed with a mild detergent. Never use corrosive materials (scouring cleansers, washing powder, bleach, etc.) or hot water.

After cleaning, wipe dry with another piece of soft, clean cloth.

Oil, juice and other liquids stick easily to the sealing strip. Clean with a soft, clean cloth dampened in lukewarm water.



OUTSIDE

Clean the outside of your refrigerator with a solution of warm water and liquid soap then dry and polish with a soft clean cloth.

Use appliance wax or liquid polish for appliances to clean and protect your refrigerator's paint finish.

Do not use dirty cloth (residue will corrode the paint), scouring pads or bleach cleaners (will scratch and weaken paint finish).

Do not put heavy or hot objects on your refrigerator lid.

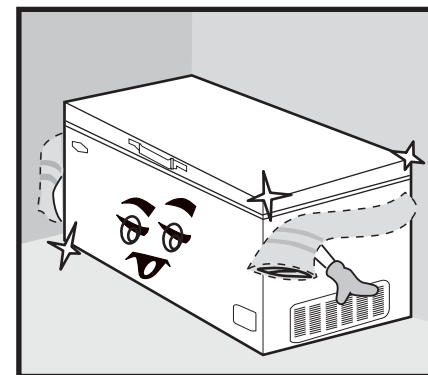

Going on Vacation

Your refrigerator should not be left unused for an extended period of time.

However, if your refrigerator will be unused for a long time, take out all inside.

- Cut off the power.

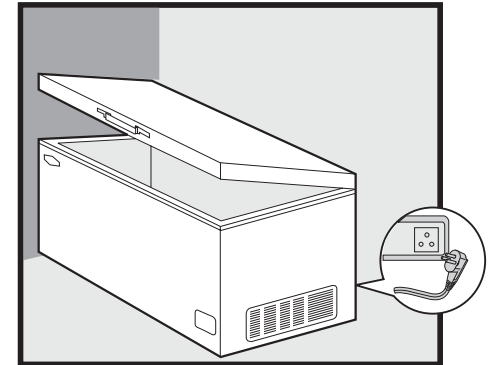

- Clean the inside with baking soda solution and wipe dry.
- Leave the lid open for 1 to 2 days to allow the inside to dry further.
- Prevent odors by leaving an open box of baking soda or a piece of charcoal inside the refrigerator
- You may put a cloth sheet over the refrigerator to prevent accumulation of dust and mildew on the sealing strip.

