

Haier

Household Refrigerator/Freezer Operation Manual

AFD631CX
AFD631CB
AFD631CS
AFL631CB
AFL631CS
AFD630IX
AFT630IX
CFL633CB
CFL633CS
CFE633CW

Table of Contents

Before use

Key features.....	1
Description of various components.....	2-3
Safety precautions	4-6
Placing environment.....	7
Preparation prior to use	8-9

Use instructions

Function introduction.....	10-14
About the fridge storage compartment.....	15-16
Fridge storage precautions.....	17
Tips on food storage in the fridge	
Storage compartment.....	18
Freezer storage precautions	19
Icemaker instructions(option)	20

Maintenance

Defrosting and cleaning	21
Stopping use.....	22
Troubleshooting	23-25

- Please read this Operation Manual carefully before using the appliance.
- Keep this Manual for future reference.
- See the physical object for the appearance, color and the door pattern.

Troubleshooting

Problems	Causes	Solutions
If you hear		
Beeps	<ul style="list-style-type: none"> ● The fridge storage compartment door is open. ● The temperature in the freezer is too high. 	<ul style="list-style-type: none"> ● Close the door or silence the alarm manually. ● The alarm is normal when it is first started due to relatively higher temperature. You can silence the alarm manually.
Abnormal sound	<ul style="list-style-type: none"> ● The refrigerator is not located on a level place. ● The refrigerator touches some object around it. 	<ul style="list-style-type: none"> ● Adjust the feet to level the refrigerator. ● Remove objects around it.
Slight sound similar to that of flowing water	<ul style="list-style-type: none"> ● This is the sound of the refrigerating system 	<ul style="list-style-type: none"> ● Normal.
Heating of cabinet	<ul style="list-style-type: none"> ● The de-condensation system is working.refrigerating system. 	<ul style="list-style-type: none"> ● This prevents condensation and is normal.



Meaning of crossed out wheeled dustbin:

Do not dispose of electrical appliances as unsorted municipal waste, use separate collection facilities. Contact you local government for information regarding the collection systems available. If electrical appliances are disposed of in landfills or dumps, hazardous substances can leak into the groundwater and get into the food chain, damaging your health and well-being. When replacing old appliances with new ones, the retailer is legally obligated to take back your old appliance for disposals at least free of charge.

Troubleshooting

Problems	Causes	Solutions
Too high temperature		
The temperature in the fridge storage compartment is too high while the temperature in the freezer is OK	<ul style="list-style-type: none"> ● The fridge temperature is set too high. 	<ul style="list-style-type: none"> ● Set the fridge temperature lower. It takes 24 hours for the temperature of the refrigerator to become stable.
Water/moisture/frost in the refrigerator		
Moisture accumulates on the refrigerator inner walls	<ul style="list-style-type: none"> ● Hot and moist climate. ● The door is not closed tightly. ● The door is opened too frequently or for too long each time. 	<ul style="list-style-type: none"> ● Accumulation of frost and moisture accelerate in such climate. ● See "Door/drawer opening/closing" in section "Problem". ● Do not open the door so frequently.
Water/moisture/frost on outside surface of the refrigerator		
Moisture accumulates on the refrigerator's outside surface or between two doors	<ul style="list-style-type: none"> ● Damp climate. ● The refrigerator door is not closed tightly. This causes condensation of the cold air in the refrigerator and the warm air outside it. 	<ul style="list-style-type: none"> ● This is normal in damp climate. The moisture will decrease when the humidity drops. ● See "Door/drawer opening/closing" in section "Problem".
Automatic icemaker		
The icemaker does not make ice	<ul style="list-style-type: none"> ● The icemaker is not turned on ● The water supply valve is not turned on ● The temperature in the freezer is not low enough ● The icemaker is not installed in place. 	<ul style="list-style-type: none"> ● Turn on the icemaker on the display panel. ● Turn on the water supply valve. ● See "Too high temperature" in section "Problem". ● Push the icemaker to its proper place.
Ice-making capacity is insufficient	<ul style="list-style-type: none"> ● The ice-making capacity is less than expected ● The temperature in the freezer is not low enough 	<ul style="list-style-type: none"> ● The icemaker can make approximately 1kg of cubed ices in 24 hours. ● Set the freezer temperature lower.
The icemaker cannot stop making ice	<ul style="list-style-type: none"> ● Its ice detection bar is pushed to a lower position by some object in the freezer storage compartment. 	<ul style="list-style-type: none"> ●
The cubed ice taste bad	<ul style="list-style-type: none"> ● Tainted by odors in the fridge or freezer storage compartment. ● The water supplied to the icemaker is not fresh. ● The cubed ices have been stored for an extended period. 	<ul style="list-style-type: none"> ● Cover all the food closely. Discard the ices stored for long period or made in the first loads. ● Add a filter on the water supply pipe. Please consult a water purification company. ● Discard the cubed ices stored too long.
Bad odors in the refrigerator		
The inside of the refrigerator is dirty	<ul style="list-style-type: none"> ● The inside of the refrigerator needs cleaning ● Food of strong odor is stored in the refrigerator 	<ul style="list-style-type: none"> ● Clean the internal of the refrigerator. ● Wrap the food tightly.

Key Features

- ◆ Removable automatic icemaker (only on some models).
- ◆ The freezer door is replaced by two drawers. This can better facilitate food access, featuring both energy saving and convenience (only on some models).
- ◆ Half-shelf structure.
- ◆ Innovative long-efficiency lighting system.
- ◆ Foldaway wine holder.
- ◆ Large crisper with humidity adjustment.
- ◆ Holiday function.
- ◆ Power ON/OFF function is set on the display panel (only on some models).
- ◆ Fridge storage compartment can be set on/off separately.
- ◆ Intelligent alarm function: automatic alarm at over temperature, malfunction, door open.
- ◆ Touch keys (only on some models).
- ◆ Deodorizer (only on some models).
- ◆ Zero degree fresh keeping.

Description of various components

Models: AFD631CX/AFD 631CB/AFD 631CS/AFL631CB/AFL631CS / AFD630IX/AFT630IX

Fridge storage compartment

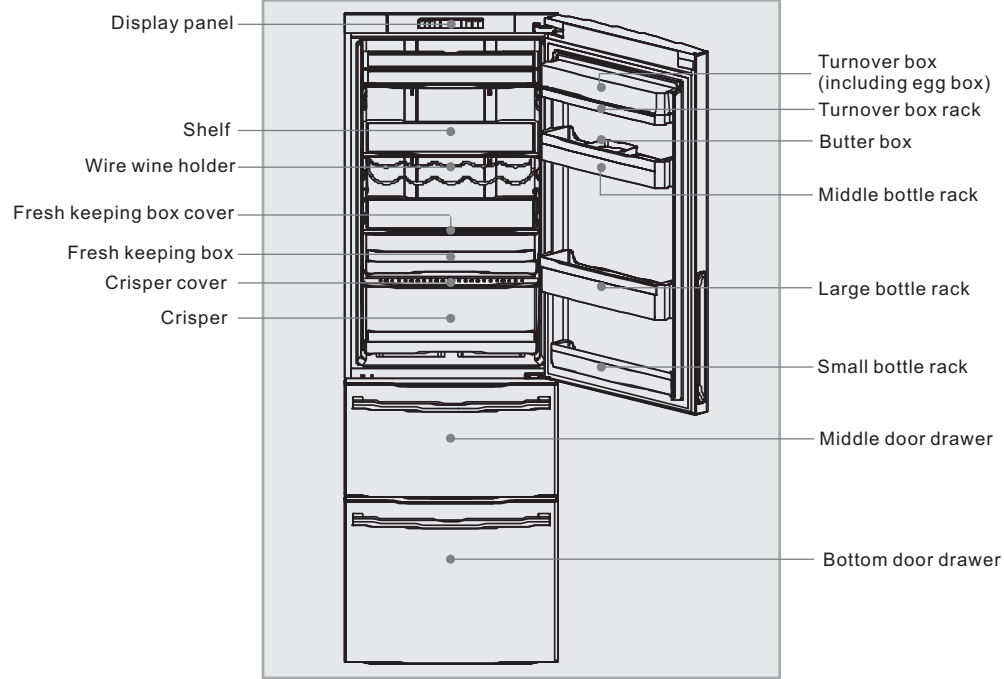

Freezer storage compartment

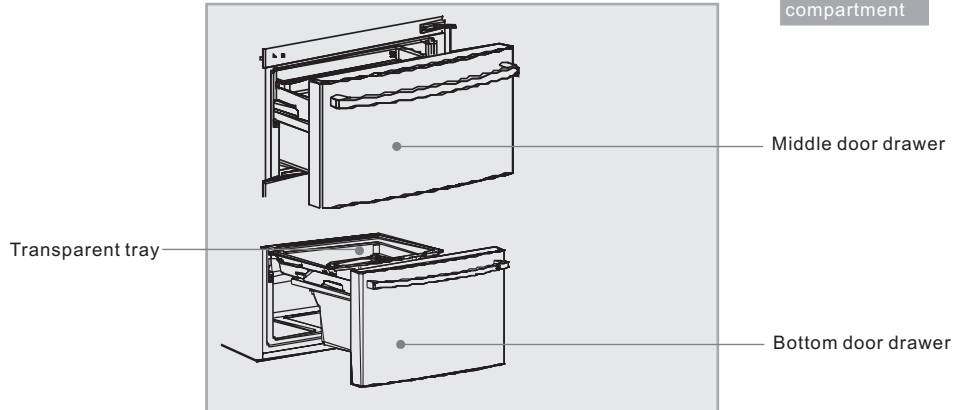

Note

The accessories shown are for several models. There may be slight differences between them and the ones on your refrigerator.

Troubleshooting

Before calling for service, please read the following troubleshooting table first. This can save both your time and money. The table contains common problems except those caused by defects in workmanship or material of the refrigerator.

Problems	Causes	Solutions
Refrigerator operation		
The compressor does not work	<ul style="list-style-type: none"> ● The refrigerator is in the defrosting cycle. ● The refrigerator is not plugged into a power outlet. ● The refrigerator is turned OFF. 	<ul style="list-style-type: none"> ● This is normal for an automatic defrosting refrigerator. ● Verify the plug is plugged in the socket firmly. ● Press the "Power" button for 3 seconds or more to restart the refrigerator or turn the knob from OFF to temperature selection position.
The refrigerator runs frequently or runs for too long period	<ul style="list-style-type: none"> ● The indoor or outdoor temperature is high. ● The refrigerator has been powered off for a period of time. ● The automatic icemaker is operating. ● The door is opened too frequently or for long period. ● The door of the fridge / freezer storage compartment is not tightly closed. ● The temperature setting for the freezer storage compartment is too low. ● The door gasket of the fridge/freezer storage compartment is dirty, worn, cracked or mismatched. ● The condenser is dirty. 	<ul style="list-style-type: none"> ● In this case, it is normal for the refrigerator to run longer. ● Normally, it takes 8 to 12 hours for the refrigerator to totally cool down. ● Ice-making process makes the refrigerator to run longer. ● Warm air enters the refrigerator and causes it to start frequently. Please do not open the door too frequently. ● Ensure the refrigerator is located on a level ground and there is no food or container jarring the door. See "door/drawer opening/closing" in section "Problem" ● Set the temperature higher until a satisfactory refrigerator temperature is obtained. It takes 24 hours for the refrigerator temperature to become stable. ● Clean or replace the door gasket. A leakage gap of door gasket can cause a longer running time of the refrigerator in order to maintain desired temperature. ● Clean the condenser.
Too high temperature		
Too high temperature in the fridge/freezer storage compartment	<ul style="list-style-type: none"> ● The door is opened too frequently or for too long each time. ● Temperature is set too high. ● The door is not closed tightly. ● The condenser is dirty. 	<ul style="list-style-type: none"> ● Warm air will enter the refrigerator whenever the door is opened. Try to open the door as less frequently as possible. ● Reset the temperature. ● See "Door/drawer opening/closing in section "Problem". ● Clean the condenser.
The temperature in the freezer is too high while the temperature in the fridge storage compartment is OK	<ul style="list-style-type: none"> ● The freezer temperature is set too high. 	<ul style="list-style-type: none"> ● Set the freezer temperature lower. It takes 24 hours for the temperature of the refrigerator to become stable.

Stopping use

Measures on power interruption

Even in summer, food may be stored in the refrigerator for a few hours after a power interruption. If a power interruption occurs, please call the power company to ask about the interruption duration.

- Do not put additional food into the refrigerator during a power interruption and try to open the door as few times as possible.
- If prior notice of a power interruption is given and the interruption duration is over 24hrs, make some ice and put it in a container in the top of the fridge storage compartment.

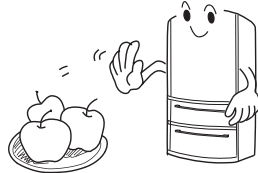

Note

As temperature in the refrigerator will rise during a power interruption or other failures, the storage period and edible quality of food will be reduced.

Stopping use

If the refrigerator will not be used for an extended period, please unplug the power cord, disconnect the water source, and clean it with the method described above. Keep the refrigerator door open to prevent any food remaining in the compartment from producing bad odors.



Note

To ensure the service life of the refrigerator, it is recommended that the refrigerator not be turned off unless it is necessary.

Before leaving for a vacation

If leaving on an extended vacation, please disconnect the power and water source. remove any food, wait for the frost to melt. Afterwards, clean and dry the interior, and keep the door open to prevent any food remaining in the compartment from producing bad odors. If the room temperature is expected drop below 0°C, please ask a qualified service person to drain the water in the water supply system. Otherwise serious property loss may be caused due to overflow of water if the water pipe or joint breaks.



Moving the refrigerator

- Unplug the refrigerator.
- Remove all food.
- Secure the shelves and crisper in the fridge storage compartment as well as the shelves and other movable parts in the freezer with adhesive tape.
- Close the door and secure with adhesive tape.
- Do not tilt the refrigerator more than 45 degrees (angle to vertical) to avoid damaging the refrigerating system.
- Do not move the refrigerator by its handle to avoid property damage or personal injury.

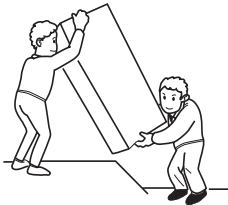

Warning

Never place the refrigerating horizontally down.



Descriptions of various components

Models: CFL 633CB/CFL 633CS/CFE 633 CW

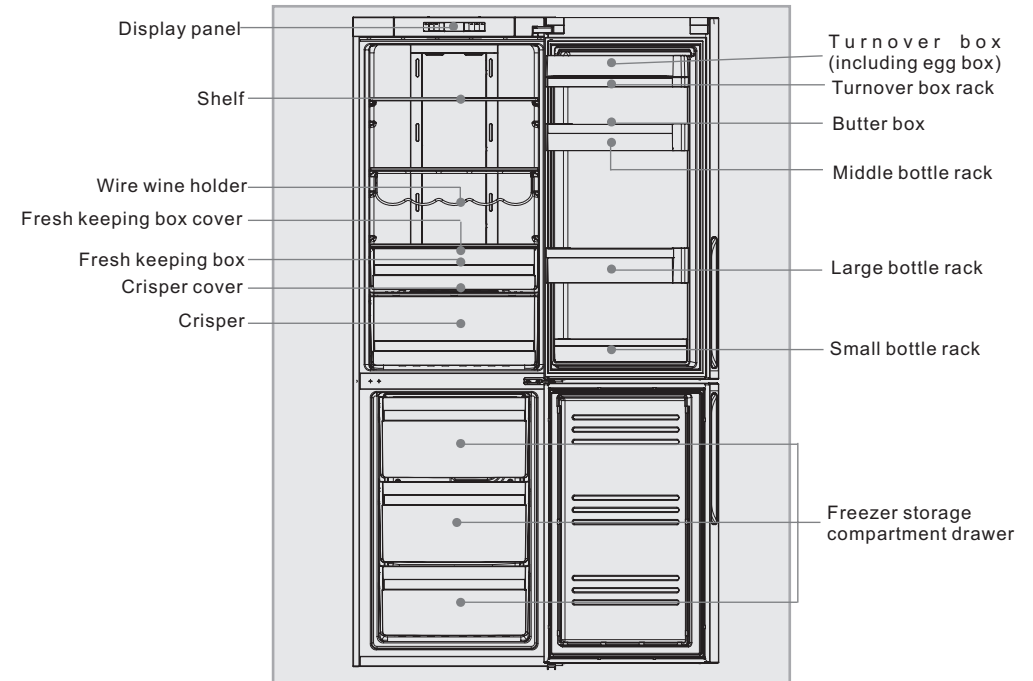

Note

The accessories shown are for several models. There may be slight differences between them and the ones on your refrigerator.

Safety precautions

The refrigerator is operated through a 220-240VAC/50Hz power supply. Abnormal voltage fluctuation may cause the refrigerator to fail to start, or damage to the temperature control or compressor, or there may be an abnormal noise when the compressor is operating. In such a case, an automatic regulator shall be mounted.

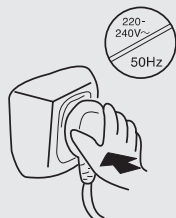

A dedicated socket with reliable grounding must be provided for the refrigerator. The refrigerator's power cable is fitted with 3-cord (grounding) plug that fits a standard 3-cord (grounding) socket. Never cut off or dismantle the third pin (grounding). After the refrigerator is installed, the plug should be accessible.

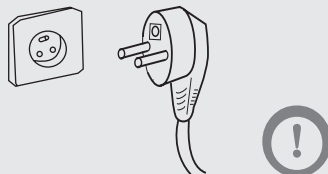

Care for the power cord

- Hold the plug, not the cord, when unplugging the refrigerator.
- Ensure that the power cord is not trapped by the refrigerator. Do not step on the power cord.
- Take care not to roll over the power cord or damage it when moving the refrigerator away from the wall.



Damaged power cord

When the power cord is damaged or the plug is worn, turn off the refrigerator and consult an authorized service agent for replacement

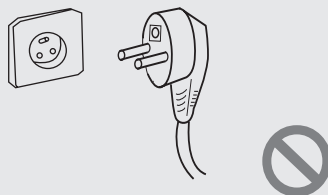

If coal gas or other inflammable gas is leaking in the vicinity of the refrigerator

- Turn off the valve of the leaking gas;
- Open the doors and windows;
- Do not unplug or plug the power cords of the refrigerator or any other appliance.



Unplug the refrigerator for the following reasons:

- Cleaning or maintenance;
- Lamp replacement



Defrosting · Cleaning

■ Defrosting the freezer

The freezer defrosts automatically. No manual operation is needed.

■ Cleaning

The refrigerator should be cleaned regularly to prevent bad stored food odors.

- For safety, unplug the power cord before cleaning the refrigerator.
- Clean the refrigerator with a soft cloth or sponge with warm water (can be added with mild detergent).
- Dry water droplets on the refrigerator surfaces with a dry cloth.

■ Use of the cleaning filter (on some models)

● The design service life is from 5 to 6 years. But as the kind and concentration of odors in each refrigerator is uncertain due to different operation condition and environment, we recommend you to set the replacement cycle within 3 years.

● After prolonged use, you can put it under sunshine for 30 minutes to recover the deodorization effect. To clean, please use slow water flow.



- ① The refrigerator is very heavy. When you are moving it for cleaning or repairs, take care not to damage the floor. Keep the refrigerator upright during moving. Do not move the refrigerator by rocking it to avoid damage to the floor.
- ② Do not spray or flush the refrigerator with water to avoid impact on its electrical insulation property.
- ③ Do not clean with hard brush, wire brush, detergent powder, gasoline, amyl acetate, acetone and similar organic solutions, warm water or acid or alkaline solutions. Please clean with special refrigerator detergent to avoid damage.
- ④ Do not touch the cold iron parts with wet hands, otherwise your skin may stick on the cold iron parts.
- ⑤ When cleaning, do not clean the cold glass shelves with warm water. Otherwise the glass may break due to sudden temperature change and cause personal injury or property loss.



Note

- Always keep the door gasket clean.



Icemaker use instructions (only on models with an icemaker)

① Preparations before using the icemaker

- Cut the water pipe to desired length while ensuring it free from excessive bend. Generally its total length is not more than 5m. Excessive longer pipe may reduce water pressure and, as a result, the water output flow-rate and ice-making capacity;
- The water pipe should be away from any heat sources as it is not heat-resistant;
- The water pipe should be installed and tested by authorized professional personnel;
- The icemaker should be connected to a water source of a pressure between 1.5bar and 7bar;

② Cleaning the ice cube tray

- Take out the icemaker assembly from the refrigerator. Turn the icemaker over and you can see the ice cube tray.
- Pull the elliptical fastener of the icemaker in direction ①.
- Take out the ice cube tray in direction ②.
- After cleaning, install it back in reversed direction

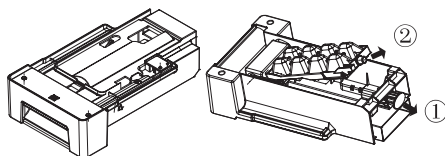

③ Precautions

- Never install the icemaker's water tube in an area with the ambient temperature below 0°C to avoid icing of water in it.
- The icemaker will start ice cube making when the internal temperature reaches or is below -12°C. (If the icemaker is used for the first time or after an extended period of vacation, the first loads of cubed ices should be discarded as there are impurities in the water tube)
- After the appliance is located, the water tube should be properly arranged to prevent it from being crushed.
- Installation of the icemaker can only be carried out by an authorized service agent.
- This icemaker can only be supplied with drinking water.

④ Operating principle of the icemaker

8 cubed ices are made in every cycle. The ice making capacity depends on ambient temperature, door-opening frequency, water pressure, freezer temperature and other conditions. To ensure that the storage box is fully filled with cubed ices, arrange the cubed ices in the drawer frequently. As the icemaker makes 8 cubed ices in one cycle, it is normal that some of them stick to each other (This can be improved by decreasing water supply duration).



Note

For a newly installed refrigerator, please let the appliance operate for 24 hours before making ice.

⑤ If this is your first icemaker

Some "crack" sound may be heard in the process of ice making. Don't worry, it's normal.

⑥ If you do not use cubed ices frequently

Cubed ices stored for an extended period may become opaque or emit a strange odor. Please empty the cubed ice storage box regularly and clean it with warm water. Before putting the box back, make sure to cool it down and to dry it under soft sunshine. Otherwise cubed ices may stick on the box.

⑦ If you do not want to use the cubed ice storage box for an extended period

Please take out all the cubed ices from the storage box and wash the box with warm water. Wipe the box with a dry towel before replacing it to the appliance. After that, turn off the valve between the water source and the appliance.

Safety precautions

Never store inflammables, explosives or corrosive materials in the refrigerator.



Do not store medicines, bacteria or chemical agents in the refrigerator. This refrigerator is a household appliance. It is not recommended to place materials that require strict temperatures.

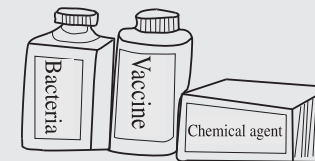

Do not store or use gasoline or other inflammable materials in the vicinity of the refrigerator to avoid a fire.



Do not place unstable articles (heavy objects, containers filled with water) on the top of the refrigerator, to avoid personal injury caused by falling or electric shock caused by contact with water

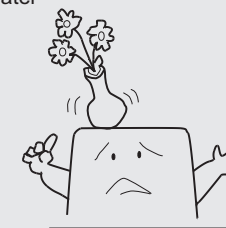

Do not swing from the bottle racks on the door. The door may be pulled slant, the bottle rack may be pulled away, or the refrigerator may topple. Do not step on the freezer storage compartment door or cabinet when putting in or taking out food.



Do not touch the inside surface of the freezer storage compartment when in operation, especially with wet hands, as your hands may freeze onto the surface.



Safety precautions

Open/close the doors only with the handles. The gap between the two doors and between the doors and the cabinets is very narrow. Do not extend your hands in these areas to avoid pinching your fingers. Open or close the refrigerator doors only when there are no children standing within range of door movement.

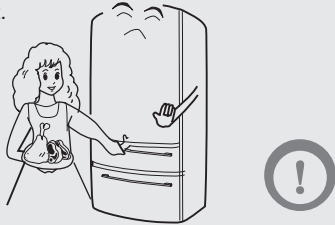

To ensure the refrigerator's electrical insulation, do not spray or flush the refrigerator when cleaning, nor place the refrigerator in a damp area or a location where it may be splashed with water.



Disassembly and alteration of the refrigerator must be authorized. Any agitated movement of the refrigerator may damage the cooling pipes. Property loss or personal injury may result. Repair of the refrigerator must be performed by professional personnel.



Never store bottled beer or beverages in the freezer, as these will burst during freezing.



Unplug the refrigerator in the event of a power interruption or before cleaning. Allow at least 5 minutes before restarting the refrigerator, as frequent starting be damage the compressor.

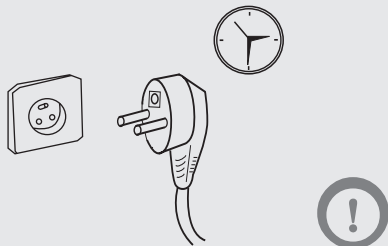

When discarding the refrigerator, to avoid the accidental entrapment of children, please remove the refrigerator doors, door gaskets and shelves and put them in an appropriate place.

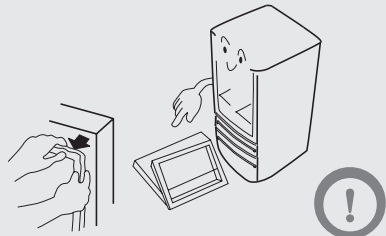

Freezer storage precautions

Hot food should not be stored in the refrigerator until it has cooled down to room temperature



Food cut into small portions will freeze faster and be easier to defrost and cook. The recommended weight for each portion is less than 2.5kg.

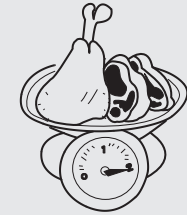

It's better to pack food before putting it in the freezer. The outside of the packing must be dry to avoid bags sticking together. Packing materials should be odor-free, airtight, non-poisonous and nontoxic.

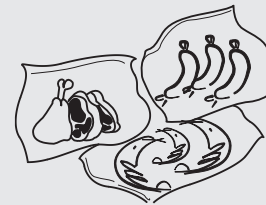

In order to avoid expiration of storage period, please note the freezing date, time limit and name of the food on the packing according to the storage periods of different foods.

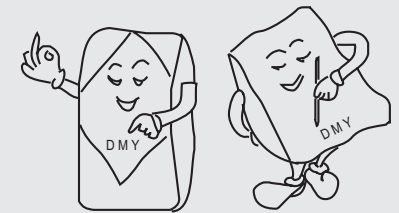

Only take the required amount of food from the freezer. Defrosted food cannot be re-frozen unless it is first cooked, otherwise it may be less edible.



Do not load excessive quantities of fresh food in the freezer. It is better to refer to the cooling capacity of the refrigerator. (See "Technical data".)

Tips on food storage in the fridge storage compartment

For turnip radish and other similar vegetables, please cut off their leaves before storage so as to prevent the nutrition from being absorbed by the leaves.

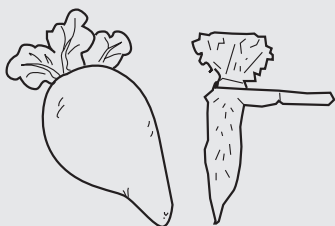

Defreeze frozen food in the fridge storage compartment. In this way you can use the frozen food to decrease the temperature in the compartment and save energy.



Some vegetables, for example, onion, garlic, ginger, water chestnut, and other rhizomatic foods, can be stored for long periods at normal temperature. There is no need to store them in the refrigerator.

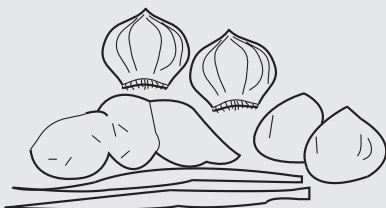

The metabolism of vegetable marrow, melons, pawpaw, banana, pineapple can be quickened in the refrigerator, so it is not suitable to store them in the fridge storage compartment. But storing green fruits in the refrigerator for certain periods can promote its maturing.



Placing environment

Leveling of the cabinet

The refrigerator should be placed on a flat and solid surface. If the refrigerator is placed on a pedestal, flat, strong and fire-resistant materials must be used. Never use the foam packing material for a pedestal. If the refrigerator is slightly unstable, you can prolong or shorten the adjustable feet of the refrigerator by turning them clockwise or counterclockwise.

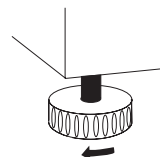

The direction shown is clockwise



Never place the refrigerator in a damp area or a location where it may be splashed with water. Clean and dry any water splashes and stains with soft cloth.

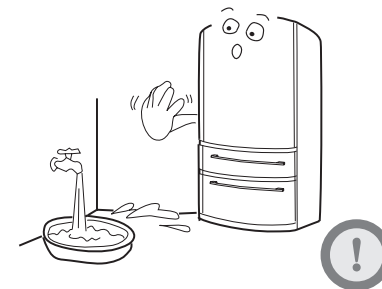

The refrigerator should be placed in a well-ventilated place not far from a drink water source. A space of at least 20cm and 10cm must be kept above and around the refrigerator.

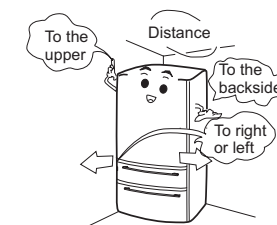

Do not store too much food in the freezer storage compartment to avoid long operation time of the compressor or falling food. It is recommended not to exceed the load line of the drawers. The total weight of the food should not exceed 30kg. To prevent the food from falling on the ground, do not pull open the freezer drawer too strong or slanted.

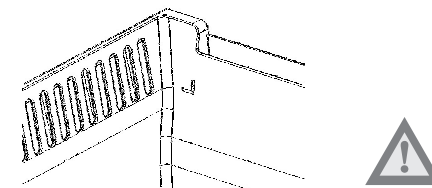

The appliance must be positioned so that the plug is accessible.

If the supply cord is damaged, it must be replaced by the manufacturer, its service agent or similarly qualified persons in order to avoid a hazard.

Warning: Keep ventilation openings, in the appliance enclosure or in the built-in structure, clear of obstruction. **Warning:** Do not use mechanical devices or other means to accelerate the defrosting process, other than those recommended by the manufacturer.

Warning: Do not damage the refrigerant circuit.

Warning: Do not use electrical appliances inside the food storage compartments of the appliance, unless they are of the type recommended by the manufacturer.

Warning: This appliance is not intended for use by persons (including children) with reduced physical, sensory or mental capabilities, or lack of experience and knowledge, unless they have been given supervision or instruction concerning use of the appliance by a person responsible for their safety.

Warning: Children should be supervised to ensure that they do not play with the appliance.

Preparation prior to use

- ① Remove all package parts
Please also remove the foam base and the adhesive tape fixing accessories.

- ② Check accompanying accessories and documents
Check the items inside the package box against the Packing List. Please inquire with the purchase shop if there is any discrepancy.



- ③ Install the handles
(AFD631CX/AFD631CB/AFD631CS/AFL631CB/AFL631CS/AFD630IX/AFT630IX) Take out the two handles from the accessory box and insert them in the handle seats respectively as shown in the figure. Secure the handles on the doors with the supplied (4) screws from bottom to upper direction.

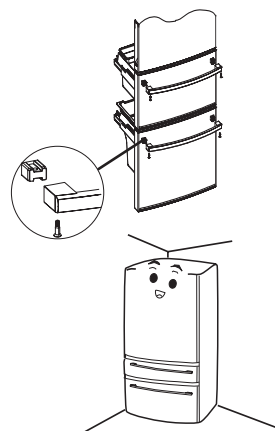

- ④ Move the refrigerator into a proper location
(See section "Placing environment")

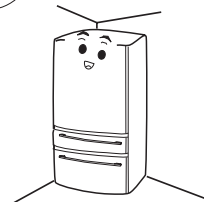

- ⑤ It is advisable to clean the cabinet before use
Please clean the inside and outside of the refrigerator with water before putting into any food in it.



- ⑥ Idle standing
After the appliance has been leveled and cleaned, let it remain idle for at least 6 hours before switching it on so as to ensure its normal running.

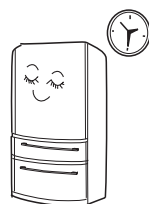

Fridge storage precautions

Hot foods must be cooled to room temperature before storing in the refrigerator.

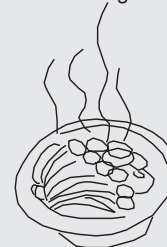

Clean the food and dry any droplets on it before placing in the refrigerator.



Food to be stored should be properly sealed. This will prevent moisture in the food from evaporating and prevent them from spoiling.



Sorted storage of food.
Food to be stored should be sorted according to their category. Food consumed daily should be placed on the front part of the shelves. This can avoid unnecessary delays in door opening as well as expiration of the storage period because you forgot to eat it.



Do not store excess quantities of food. Food should be stored with spaces in between them. This allows cold air to flow smoothly and therefore obtain better storage results.

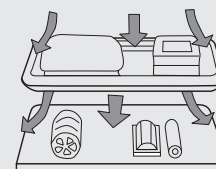

Do not place the food too near to the inner walls. Do not store foods with high moisture content clinging to the inner walls. Otherwise they may freeze to the walls. Place food a little away from the inner walls.



Note

Avoiding food (especially oil food) contact with the inner liner directly, as oil can erode the inner liner. So it's better to clean the oily dirt whenever it is found.

About the fridge storage compartment

Use of the foldaway shelf

Fig. ① shows the extended state of the foldaway shelf in which you can put lower food containers.

Fig. ② shows the folded state of the foldaway shelf in which you can put higher food containers.

To fold the shelf from state ① to state ②, simply push structure A upwards, and push structure B inward in the direction of the arrow shown in the figure.

To extend the shelf from state ② to state ①, push structure A upwards, and pull structure B in the direction of the arrow shown in the figure.

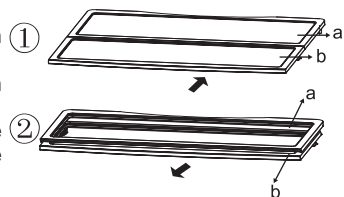

Use of the wire wine holder

Fig. ① shows the folded state of the wire wine holder. In this state large space can be spared.

Fig. ② shows the extended state of the wire wine holder. In this state it can hold various wines.

To extend it from state ① to state ②, simply pull the wire down.

To fold it from state ② to state ①, simply push the wire up.

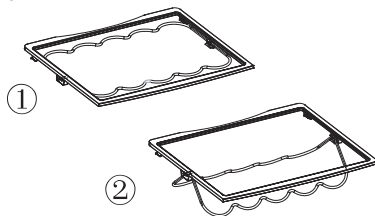

Note

make sure to keep the two ends of a shelf on the same level. Otherwise it may fall or the food on it may dump.

Preparation prior to use

① Connection to power supply

When the refrigerator is connected to power supply, the fridge temperature and freezer temperature are automatically set to 5°C and -18°C respectively.

② Operation modes of the refrigerator

Manual adjustment mode: can set temperature by pressing the temperature setup key (see "Function description" hereafter).

③ Loading the refrigerator with food

Load the refrigerator with food after it has been operates for a period and the inside is cool enough.



Note

Some time will be required for the refrigerator to reach the set temperature when the setting is changed. The length of this period depends on the difference between the existing and set temperatures, ambient temperature, door opening frequency and the amount of food in storage.

Recommended storage areas for various foods

As cold air circulates inside the refrigerator, there is temperature difference inside the fridge storage compartment. Different foods should be placed in different areas according to their properties.

- ① Eggs, butter, cheese and etc.
- ② Drinks, canned food and etc.
- ③ Seasonings and pickled food
- ④ Beverages, canned food, cake, etc.
- ⑤ Wine, champagne, etc.
- ⑥ Milk, cheese, etc
- ⑦ Cooked meat, fresh fish and meat, etc.
- ⑧ Fruit, vegetables, salad, etc.

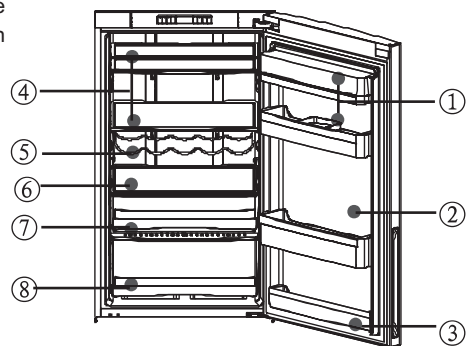

Lamp in the fridge storage compartment and its replacement

Parameters of the lamp: 12V, max 5W(the power depends on the model). The lamp adopts LED as its light source, featuring low energy consumption and long service life. If there is any abnormality, please contact the after-sales service personnel.

Function introduction

(1) Models: CFE633CW

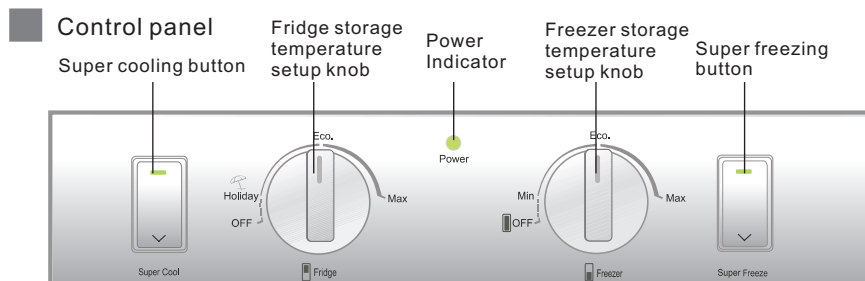

Initial powering on

Upon initial powering on, the power indicator will illuminate. There will be alarm due to high temperature in the freezer storage compartment. You can cancel the alarm by pressing any key.

Fridge storage temperature setup

The temperature in the fridge storage compartment can be set by turning the fridge storage temperature setup knob. There are three temperature positions for refrigerating: Holiday, Moderate and Super Cool.

Freezer storage temperature setup

The temperature in the freezer storage compartment can be set by turning the freezer storage temperature setup knob. There are three temperature positions for freezing: Weak, Moderate and Super Freeze.

Super cooling

Select this function after you have put fresh food in the fridge storage compartment. Press the super cooling button, the refrigerator activates this function and corresponding indicator illuminates. This function will automatically deactivate when the temperature decreases to the required level. You can also deactivate it by pressing the super cooling button again.

Super freezing

Select this function after you have put large amount of food in the freezer storage compartment. Press the super freezing button, the refrigerator activates this function and corresponding indicator illuminates. This function will become automatically deactivate after 24 hours. You can also deactivate it by pressing the super freezing button again.

Holiday function

Turning the fridge storage temperature setup knob to "Holiday" will activate the holiday function of the fridge storage compartment. It will operate at a relatively high temperature. (Please remove any fresh food from the fridge storage compartment and close the door before activating this function)

Display control

The display screen will turn off automatically 1 minute after an operation is finished. It will be lit up by opening the door or pressing any key. (Alarm does not light up the display screen)

Door open alarming

When the refrigerator door is open for more than 3 minutes, the super cooling indicator will flash and the buzzer will sound 3 beeps every 30 seconds. The buzzer can be silenced by closing the door or pressing any key.

About the fridge storage compartment

Please put the food to be stored for short period or for daily consumption in the fridge storage compartment:

Although the average temperature in most areas in the fridge storage compartment can be regulated between 0°C and 10°C, extended period of food storage is not recommended. The fridge storage compartment should only be used for short-term storage.



Adjusting shelf height

The shelf can be relocated to accommodate food size or height. To adjust the height of a shelf, remove it first in this way: uplift its front edge and then pull it out.

To install the shelf, put the dogs on both sides of the shelf on the supporting ribs and push it to the most inward end.

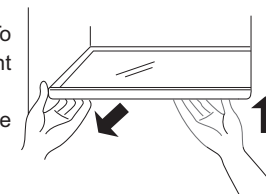

Fruit & Vegetable box

The refrigerator has a crisper. You can adjust the humidity inside it according to the properties of the foods.

- Turning the humidity control button rightward enables the crisper to keep in a higher humidity suitable for cucumbers, grapes, Chinese gooseberries, persimmons, etc.

- Turning the humidity control button leftward enables the crisper to keep in a lower humidity suitable for strawberries, oranges, beans, garlic, watermelon, plums, tomatoes, etc.

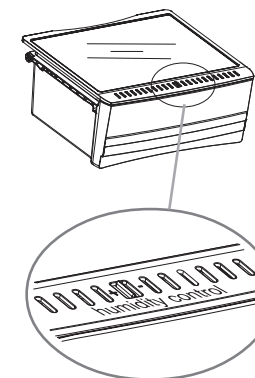

Fresh control box

The temperature in this box is kept at approx 0°C, it may be slightly changed due to the different ambient temperature or refrigerator working style. It is suitable to store fresh fish, meat and cooked food in 1~2 days.

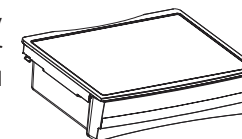

Disassemble of Clean the bottle

To take out a bottle guard, uplift the bottle guards in direction ① and grip both sides and pull it out in direction ②. After cleaning, install it with the operation in the reversed direction.

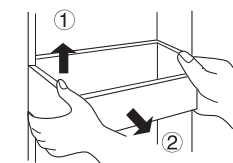

Function introduction

Super cooling

Press key A2 until icon B flashes. Then, press key A5 to confirm the super cooling function. Icon B will illuminate solid. You can deactivate the super cooling function with the same operation.

Holiday function

Press key A2 until icon C flashes. Then, press key A5 to confirm the holiday function. Icon C will illuminate solid. You can deactivate the holiday function with the same operation.

Super freezing

Press key A2 until icon I flashes. Then, press key A5 to confirm the super freezing function. Icon I will illuminate solid. You can deactivate the super freezing function with the same operation.

Ice making function (only on models with an icemaker)

Press key A2 until icon J flashes. Then, press key A5 to confirm the ice making function. Icon J will illuminate solid. You can deactivate the ice making function with the same operation.

Icemaker's water injection time adjustment (only on models with an icemaker)

Press key A2 until icon K flashes. Then, press key A5 to confirm the icemaker's water injection time adjustment. Icon K will illuminate solid. The water injection time will be indicated with icon H and icon D. For example, if the time is 4.0s, icon H will be 4 and D will be 0. Press key A3 or A4 to set the time in an increment of 0.5s. It cycles from 2s to 7s. After you have set it to the desired value, press key A5 to confirm. Icon K will go off. You can exit the icemaker's water injection time adjustment with the same operation.

Note: this operation can be performed only when the ice making function is selected.

Display control

The display screen will dim 1 minute after an operation is finished. It will recover to normal brightness when you open the door or press any key. (Alarm does not light up the display screen)

Door open alarming

When the fridge storage compartment door is open for more than 3 minutes, icon G will flash and the buzzer will give out 3 beeps every 30 seconds. If you close the door, the alarm will be silenced and icon G will go off. You can also silence the buzzer by pressing key A5.

Over temperature alarming

When the temperature in the freezer storage compartment rises to a certain value, icon G will illuminate solid and the buzzer will sound 1 beep every second. When the temperature in the freezer storage compartment drops to a specified level, the alarm will silence and icon G will go off. You can also silence the buzzer by pressing key A5.

Switching off the fridge storage compartment

Press and hold key A1 for 3 seconds, the fridge storage compartment will be turned off while the freezer storage compartment is operating normally. At this time, icon D will go off and icon E will become dim.

Press and hold key A1 for 3 seconds again, the fridge storage compartment will be turned on, icon D will recover, and icon E will recover its normal brightness.

Note: if super cooling or holiday function is selected previously, the function will be deactivated and corresponding icon will turn off when the fridge storage compartment is turned off

Switching off the refrigerator

Press and hold key A6 for 3 seconds, the display panel will go off and the refrigerator will stop operating. Press and hold key A6 for 3 seconds again, the display panel will light up and the refrigerator will start operating normally. This function is not equivalent to turning off the power.

Error indication

When E or F is displayed due to fault, the refrigerator can still refrigerate. Please contact professional after sales service personnel as soon as possible.

Function introduction

Over temperature alarm

When the temperature in the freezer storage compartment rises to a certain value, the Super Freeze indicator will flash and the buzzer will sound 1 beep every second. The buzzer may be silenced when the temperature in the freezer storage compartment drops to a specified level or by pressing any key.

Turning off the fridge storage compartment

Set the fridge storage temperature to OFF. The fridge storage compartment will be turned off while the freezer storage compartment operates normally.

Turning off the refrigerator

Set the freezer storage temperature to OFF. The refrigerator will stop operating. This function is not equivalent to turning off the power.

(2) Models: CFL633*/AFL631*

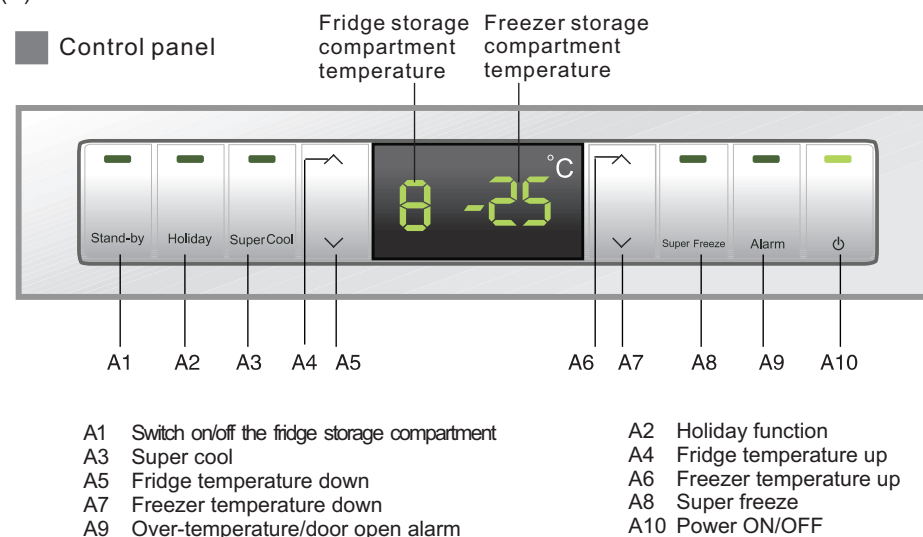

Initial powering on

When the refrigerator is powered on for the first time, the power indicator and the fridge storage compartment indicator will light. The fridge storage temperature will be displayed as "-" due to the high temperature inside. The freezer storage temperature will be displayed as "- -" due to high temperature inside. The buzzer will beep. Press key A9, and the buzzer will be silenced. After the temperature decreases to certain level, the displayed temperatures of the fridge storage compartment and the freezer storage compartment will become the ex-factory settings "5" and "-18" respectively.

Fridge storage temperature setup

Press key A4 or A5 to set the fridge storage temperature. The fridge storage temperature cycles from 1 to 8. The setting is confirmed automatically 5 seconds after the operation is finished or by pressing any other key.

Function introduction

Freezing storage temperature setup

Press key A6 or A7 to set the freezer storage temperature. The freezer storage temperature cycles from -14 to -26°C. It will be confirmed automatically 5 seconds after the operation is finished or by pressing any other key.

Super cooling

Select this function after you have put fresh food in the fridge storage compartment. Press key A3, and this function is activated and the corresponding indicator illuminates. This function will automatically deactivate when the temperature decreases to the required level. You can also deactivate it by pressing key A3 again.

Super freezing

Select this function after you have put large amount of food in the freezer storage compartment. Press key A8, this function is activated and the corresponding indicator illuminates. This function will become inactive automatically after 24 hours. You can also deactivate it by pressing key A8 again.

Holiday function

Press key A2, corresponding indicator illuminates and the holiday function of the fridge storage compartment is activated. It will operate at a relatively high temperature in Holiday mode. The fridge storage temperature will be indicated as “-” (Please take out the fresh food in the refrigerator and close the door before activating this function). Press key A2 again, and the corresponding indicator goes off and the refrigerator comes into normal control.

Display control

The display screen will turn off automatically 1 minute after an operation is finished. It can be lit up by opening the door or pressing any key. (Alarm does not light up the display screen)

Door open alarming

When the refrigerator door is open for more than 3 minutes, the alarm indicator will flash and the buzzer will sound 3 beeps every 30 seconds. The buzzer can be silenced by closing the door or pressing key A9.

Over temperature alarm

When the temperature in the freezer storage compartment rises to a certain value, the alarm indicator will illuminate solid and the buzzer will sound 1 beep every second. The buzzer can be silenced when the temperature in the freezer storage compartment drops to a specified level or key A9 is pressed.

Turning off the fridge storage compartment

Press and hold key A1 for 3 seconds, and the corresponding indicator will turn off and the fridge storage compartment will be turned off while the freezer storage compartment operates normally. The fridge storage temperature indication icon will also go off. Press and hold key A1 for 3 seconds again, the corresponding indicator will illuminate, the fridge storage compartment will be turned on, and the fridge storage temperature indication icon will recover.

Turning off the refrigerator

Press and hold key A10 for 3 seconds, corresponding indicator will go off, the display panel will go off and the refrigerator will stop operating.

Press and hold key A10 for 3 seconds again, corresponding indicator will light up, the display panel will light up, and the refrigerator will start operating normally.

This function is not equivalent to turning off the power.

Fault indication

When E or F is displayed due to fault, the refrigerator can still refrigerate. Please contact professional after-sales service personnel as soon as possible.

Function introduction

(3) Model: AFD631*

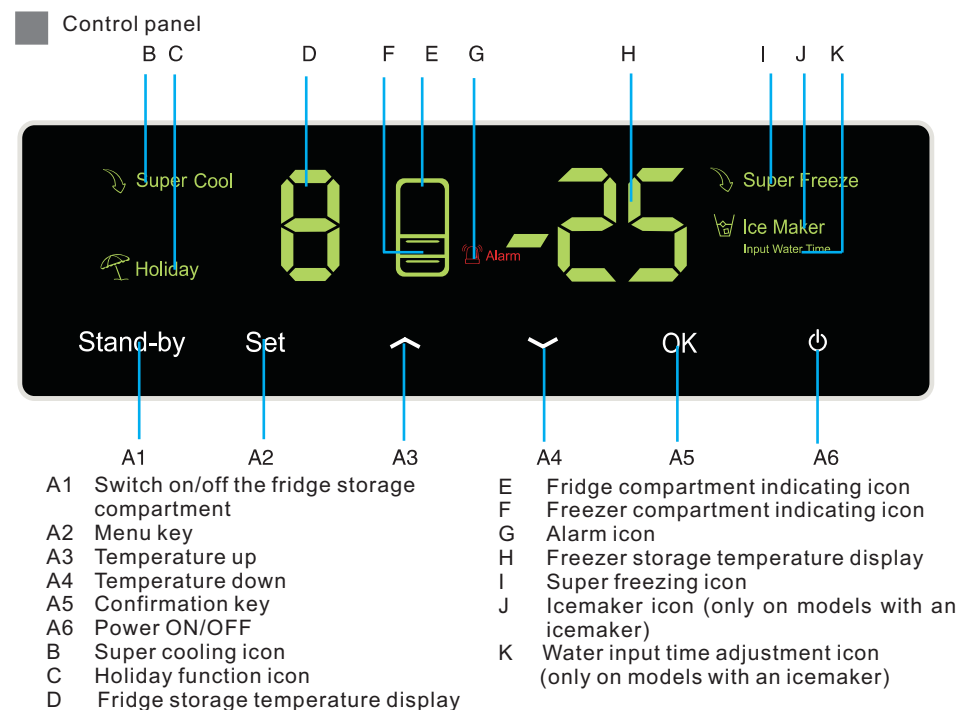

Initial powering on

When the refrigerator is powered on for the first time, icon G will light. The fridge storage temperature will be displayed as “-” due to high temperature inside. The freezer storage temperature will be displayed as “-” due to high temperature. The buzzer will beep. Press key A5, the buzzer will be silenced and icon G will remain lit. After the temperature decreases to certain level, icon G will turn off and the displayed temperatures of the fridge storage compartment and the freezer storage compartment will become the ex-factory settings “5” and “-18” respectively. The brightness of D, E, H icon will decrease to half automatically when the refrigerator is not being operated.

Fridge storage temperature setup

Press key A2 until icon D flashes. Then, press key A3 or A4 to set the temperature. The refrigerating storage temperature cycles from 1 to 8. After you have set it to the desired value, press key A5 to confirm.

Note: Flashing of icon D is accompanied by flashing of icon E

Freezer storage temperature setup

Press key A2 until icon H flashes. Then, press key A3 or A4 to set the temperature. The freezing storage temperature cycles from -14 to -26. After you've set it to the desired value, press key A5 to confirm.

Note: Flashing of icon H is accompanied by flashing of icon F