

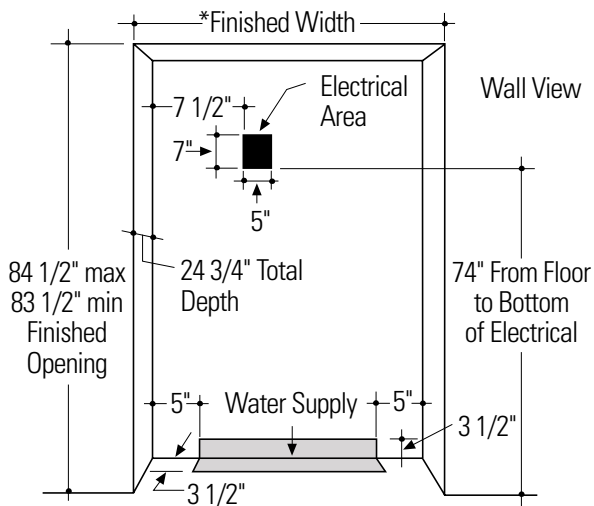

Monogram™

ZIR36ND-GE Monogram 36" Built-In All-Refrigerator

Product Dimensions (in inches)

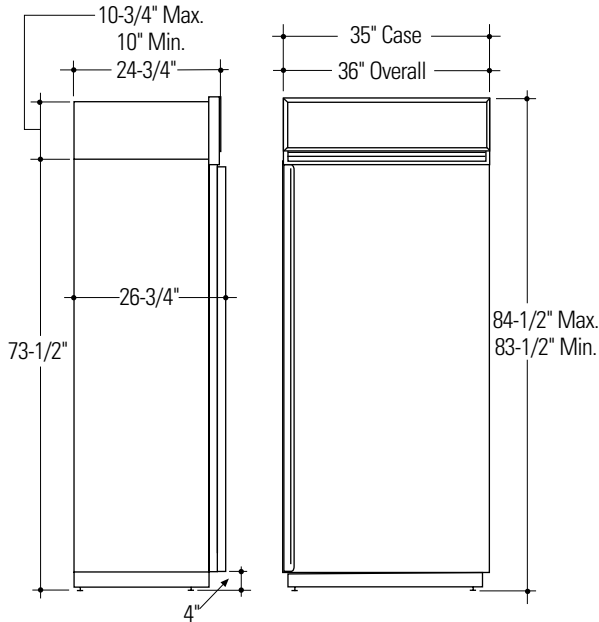

* 36" Min. for a flush installation into an enclosure.

* 35-1/2" Min. for a semi-flush installation into an enclosure.

Note: Additional cutout width may be required when side panels are used. Add side panel thickness to the finished cutout width to calculate rough-in width.

Design Information

Designed to be installed flush or semi-flush with surrounding cabinetry. Cutout dimensions, clearances and side panel sizes are determined by the many installation options available. Side panels must be used whenever the sides of the refrigerator will be exposed. Side panels are not required when installed into an enclosure or between pantry and oven cabinets. **IMPORTANT** - Side panels, 1/2" minimum thickness are required when using FRAMELESS CABINETS.

- Field installed custom panels, Lexan® or stainless steel panels are required. The door and grille panel sizes vary to accommodate the kit being used.
- The supplied toekick is vented and must remain unobstructed for proper air circulation.

Optional Panel Kits:

- ZWBR36: Black Lexan® Panel Kit
- ZWWR36: White Lexan® Panel Kit
- ZWSR36: Stainless Steel Panel Kit

Optional Custom Trim Kits:

- ZKHR1: For installation of a custom handle of your choice onto a 1/4" Panel.
- ZKTR36LH or ZKTR36RH: For installation of a 3/4" thick custom panel.
- ZKHTR1: For installation of a custom handle of your choice onto a 3/4" thick panel. (This kit must be used in combination with ZKTR36LH or ZKTR36RH).
- ZKHRSS1: Tubular Stainless Steel handle for 1/4" thick panel.
- ZKHTRSS1: Tubular Stainless Steel handle for 3/4" thick panel.
- ZGC2: 1/4" grille panel frame side pieces for 83-1/2" and 84-1/2" installation heights. (Factory set for 84").
- ZWT1: White toekick (supplied toekick is black).
- ZFC1: Trim strip for side-by-side installation of two products.

Additional Specifications

- A 115 volt 60Hz., 15 or 20 amp power supply is required. An individual properly grounded branch circuit or circuit breaker is recommended. Install a properly grounded 3-prong electrical receptacle recessed into the back wall. Electrical must be located on rear wall as shown.
- Water line can enter opening through the floor or back wall. The water line should be 1/4" O.D. copper tubing between the cold water line and water connection location, long enough to extend to the front of the refrigerator. Installation of an easily accessible shut off valve is recommended.

Clearances:

- If the refrigerator or freezer is installed in a corner: A 4" clearance is required on the hinge side for a 90° door opening and access to fresh food drawers. A 10" clearance is required on the hinge side to remove pans.

For answers to your Monogram® GE Profile Performance Series™ GE Profile™ or GE appliance questions, call GE Answer Center® service, 800.626.2000.





Monogram™

ZIR36ND–GE Monogram 36" Built-In All-Refrigerator

Advanced Planning

Flush or Semi-Flush Enclosure Installation

True Flush Installation

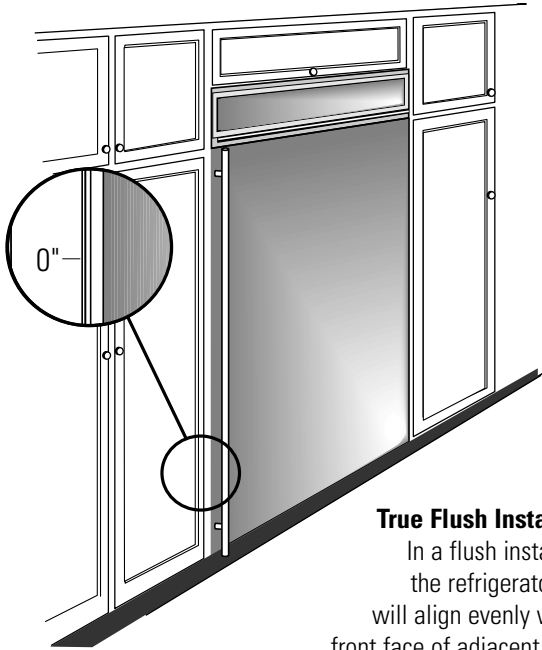

True Flush Installation
In a flush installation, the refrigerator doors will align evenly with the front face of adjacent cabinet doors. The refrigerator blends into the surrounding cabinetry.

Semi-Flush Installation

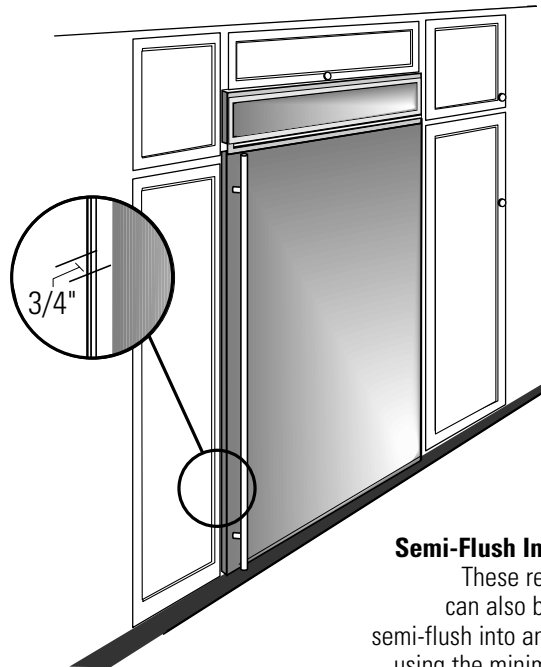

Semi-Flush Installation
These refrigerators can also be installed semi-flush into an enclosure using the minimum cutout width. The case trim creates a frame around the opening.

Monogram built-in refrigerators and freezers can be installed flush with typical 24-3/4" deep cabinetry.

When installed semi-flush, the case trim will conceal slight gaps around the enclosure. The refrigerator or freezer will project forward approximately 3/4" beyond the front face of surrounding cabinetry.

In any installation situation, a wide range of appearance options can be accomplished through the use of one or more trim kits.

Side Panel Requirements:

- Side panels are not required whenever the refrigerator is installed into an enclosure or between pantry and oven cabinets.
- Side panels are required whenever the sides of the refrigerator are exposed.
- Side panel sizes vary depending on the type of installation being made.

To accomplish an attractive installation, you must:

1. Determine the need for side panels.
2. Determine side panel thickness.
3. Order matching side panels from the cabinet manufacturer. Be sure to provide the exact S dimensions.

For answers to your Monogram®, GE Profile Performance Series™, GE Profile™ or GE appliance questions, call GE Answer Center® service, 800.626.2000.





Monogram™

ZIR36ND-GE Monogram 36" Built-In All-Refrigerator

Side By Side Installation of Freezer and Refrigerator

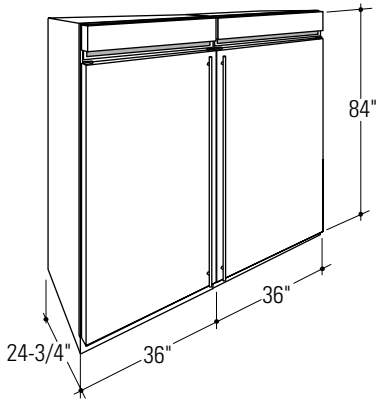

For a complete food storage center, install a Monogram Freezer and Refrigerator side by side. For even more capacity, install two refrigerators and one or two freezers. Order ZFC1 Trim Kit to cover the side trim and/or gap between the two products.

- The electrical and water locations must be located as shown for either type of installation. A separate 115V, 60Hz, 20 amp power supply is recommended for each product.

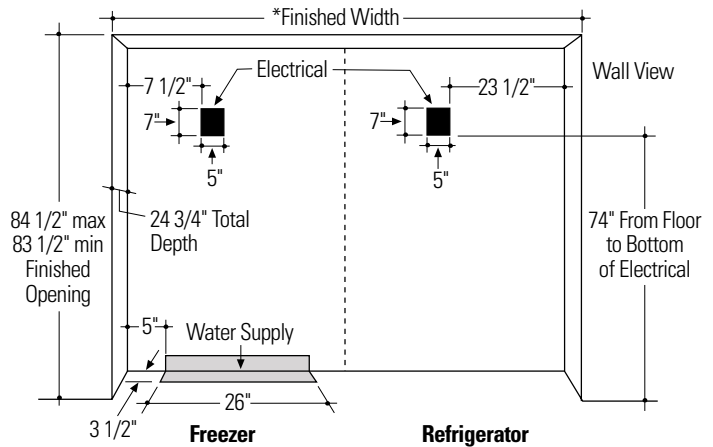

*72" min. for a flush installation
71-1/2" min. for a semi-flush installation

Note: Additional cutout width may be required when side panels are used. Add side panel thickness to the finished cutout to calculate rough-in width.

Installation Between Base and Wall Cabinet

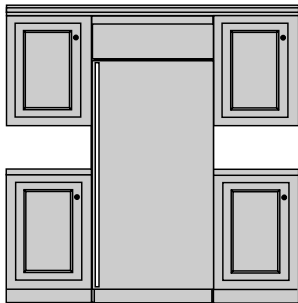

Refrigerator or Freezer

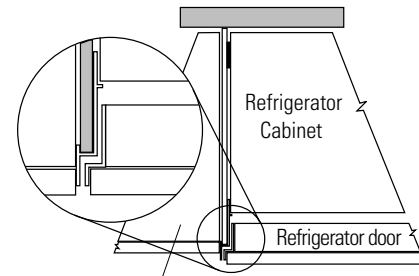
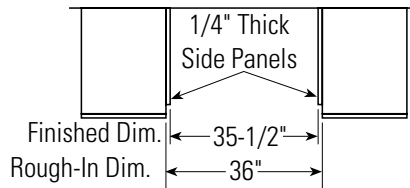

Cabinet

Note: 1/4" thick side panels can be inserted into the case trim, making the rough-in the same as the outside trim width, 36".

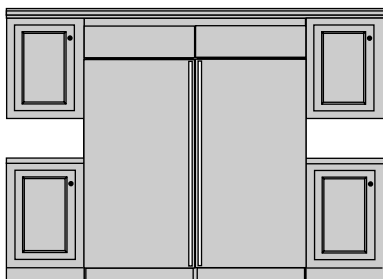

Refrigerator and Freezer installed side-by-side

ZFC1 Trim Kit is recommended to cover side trim and/or gap between the two products.

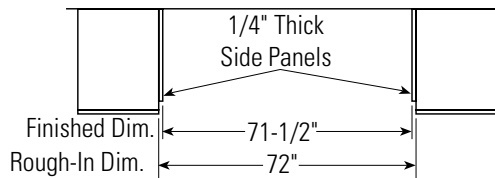

For answers to your Monogram® GE Profile Performance Series™ GE Profile™ or GE appliance questions, call GE Answer Center® service, 800.626.2000.





Monogram™

ZIR36ND–GE Monogram 36" Built-In All-Refrigerator

Installation at End of Run

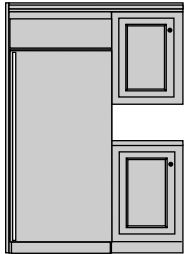

Refrigerator or Freezer

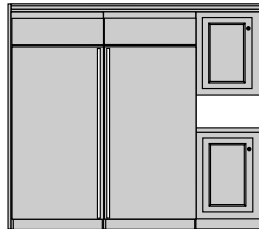

Refrigerator and Freezer installed side-by-side

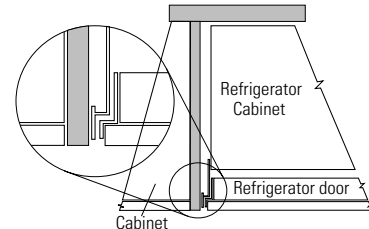

Note: 1/2" thick side panels shown. Side panels can be any thickness. Add side panel thickness to outside trim width, (36" or 72" for two models) to calculate the rough-in dimension. The leading (front) edge must be finished to match surrounding cabinetry.

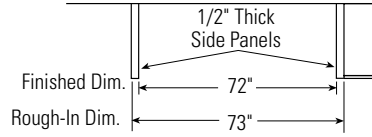
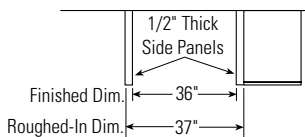

Frameless Cabinets

Side panels, 1/2" minimum thickness are required when using frameless cabinets. The side panel acts as a spacer between the cabinet and the case trim and prevents interference with cabinet door swing. The leading (front) edge must be finished to match surrounding cabinetry.

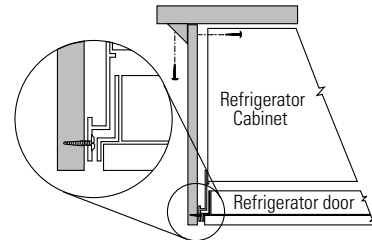

1/2" To 3/4" Side Panels. Leading Edge Flush With Cabinet

Accessory Panel Kits

These refrigerators and freezers require field installed door and grille panels. The factory installed trim will accept accessory panel kits. White or black Lexan® and stainless steel kits are available. Panels are cut to size and ready to install. These panel kits must be ordered separately.

A wide range of custom appearance options can be created with optional trim kits.

- ZWBR36, Black Lexan® Panels
- ZWWR36, White Lexan® Panels
- ZWSR36, Stainless Steel Panels

Accessory Panel Kits Advanced Planning Exterior Appearance Options

These refrigerators and freezers are designed to be customized with decorator door and grille panels. Field installed custom door and grille panels are required for these models.

Factory installed trim will accommodate 1/4" thick custom panels, Lexan® or stainless steel panel kits.

Door and grille panel sizes vary to accommodate the kit being used. Sizes are provided in this booklet.

Caution: Maximum door panel weight is 50 pounds.

Side panels must be used whenever the sides of the refrigerator will be exposed. Side panel sizes vary depending on the installation.

3/4" thick custom panels-Without trim kits

A raised panel design, screwed or glued to a 1/4" thick backing can be used.

You should:

1. Select the appearance option.
2. Order the trim kit for that option.
3. Order the custom door and grille panels from the cabinet manufacturer. The exact dimension for each trim kit application is provided in this booklet. Find and pull out the page for your application and fax or send it to the cabinet manufacturer. The cabinet manufacturer must have this information to construct the panels accurately.
4. Determine the final installation situation and order matching side panels.

For answers to your Monogram®, GE Profile Performance Series™, GE Profile™ or GE appliance questions, call GE Answer Center® service, 800.626.2000.





Monogram™

ZIR36ND–GE Monogram 36" Built-In All-Refrigerator

Custom Door Panel Dimensions Using Standard Trim

1/4" thick panels or
Panels secured to 1/4" thick backing

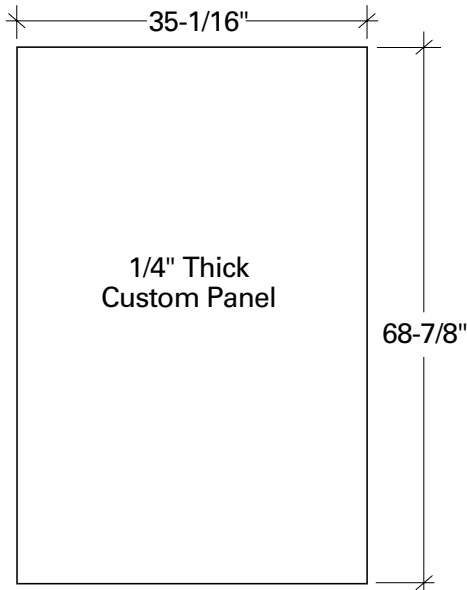

Important: Maximum panel is 50 pounds

ZIR36N Refrigerator
ZIF36N Freezer

- 1/4" Panel: Cut panels to size.
- Custom handle with 1/4" door panel requires Trim kits ZKHR1 or ZKHRSS1 for tubular stainless steel handles.

Standard Trim with Panels secured to 1/4" thick backing

- Applying a raised panel design to a 1/4" thick backing (screws or glued): Cut 1/4" thick panels to size. Fabricate the raised panel to permit at least 2" fingertip clearance of the standard handle. 1-1/4" clearance from the hinge side to avoid striking adjacent cabinetry and 5/16" from the top and bottom edges to allow for the trim flange.

Note: ZKHTR1 custom handle kit cannot be used in this configuration.

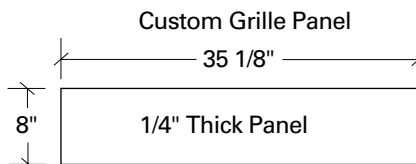

The grille panel frame is factory assembled for 84" installation height. If installation height varies, order ZGC2 trim kit that provides optional side trim pieces. Cut grille panel to sizes shown below.

Raised Panel on 1/4" Thick Backing
Using Standard Handles

Installation Height	Panel Height
83-1/2"	7-1/2"
84-1/2"	8-1/2"

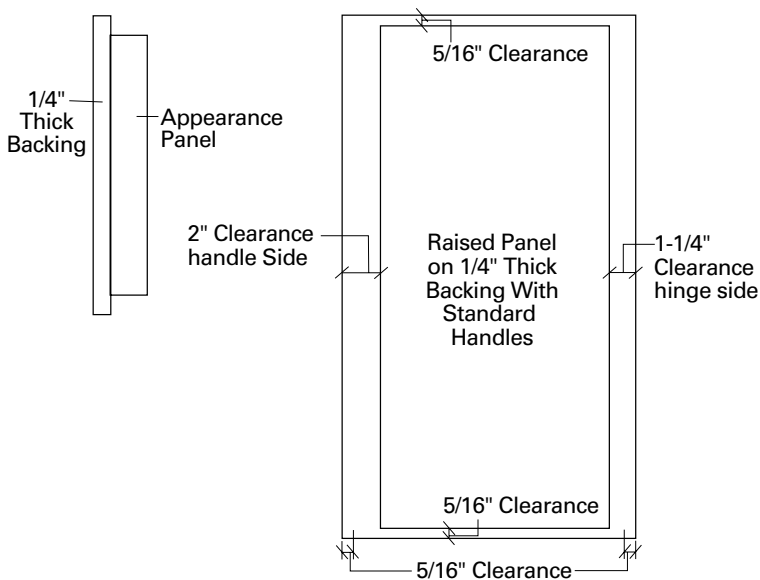

For answers to your Monogram®
GE Profile Performance Series™
GE Profile™ or GE appliance questions, call
GE Answer Center® service, 800.626.2000.





Monogram™

ZIR36ND–GE Monogram 36" Built-In All-Refrigerator

Custom Door Panel Dimensions

Using Trim Kits ZKTR36LH or ZKTR36RH
3/4" thick panel with kit supplied handle

ZIR36N Refrigerator
ZIF36N Freezer

- The ZKTR36LH (or ZKTR36RH) trim kit provides for the installation of 3/4" thick custom door and grille panels, using the supplied handle. Cut panel to size and install.

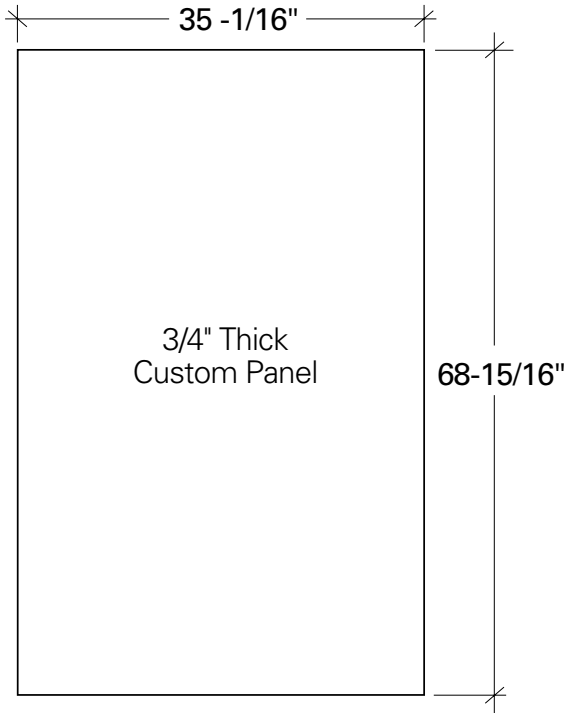

Important: Maximum panel is 50 pounds

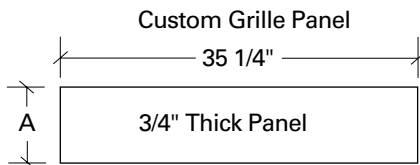

Grille Panel height can vary to fill installation height.

Installation Height	Dimension A
83-1/2"	7-1/2"
84"	8-1/2"
84-1/2"	8-3/4"

Important: Maintain 1-1/2" min. gap between top of door and bottom of grille panel.

For answers to your Monogram® GE Profile Performance Series™ GE Profile™ or GE appliance questions, call GE Answer Center® service, 800.626.2000.





Monogram™

ZIR36ND–GE Monogram 36" Built-In All-Refrigerator

Custom Door Panel Dimensions Using Standard Trim

Using Trim Kit ZKTR36LH or ZKTR36RH
3/4" thick panel with custom handle

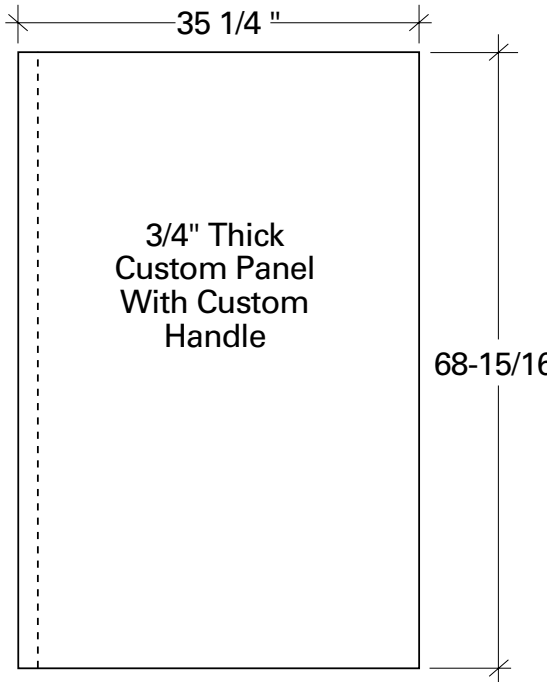

ZIR36N Refrigerator
ZIF36N Freezer

- The ZKTR36LH (or ZKTR36RH) trim kit installed together with a ZKHTR1 custom handle kit provides for the installation of 3/4" thick custom door and grille panels with a custom handle of your choice. Order ZKHTRSS1 for a tubular stainless steel handle. Cut panels to size, rout the handle side of the panel as shown below and install.

Important: Maximum panel is 50 pounds

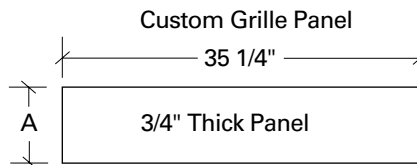

Grille Panel height can vary to fill installation height.

Rout back side of panel as shown on the handle side

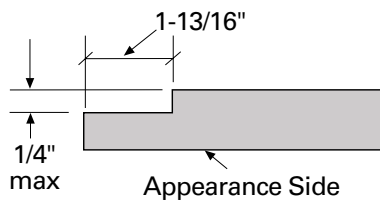

Installation Height	Dimension A
83-1/2"	7-1/2"
84"	8-1/2"
84-1/2"	8-3/4"

Important: Maintain 1-1/2" min. gap between top of door and bottom of grille panel.

For answers to your Monogram®
GE Profile Performance Series™
GE Profile™ or GE appliance questions, call
GE Answer Center® service, 800.626.2000.

Specification Created 8/00





Monogram™

ZIR36ND—GE Monogram 36" Built-In All-Refrigerator

Side Panel or Filler Options (Not to scale)

Side panels must be used whenever the sides of the refrigerator or freezer will be exposed.

1/4" Side Panels
Insert end of
side panel into trim.

Top View

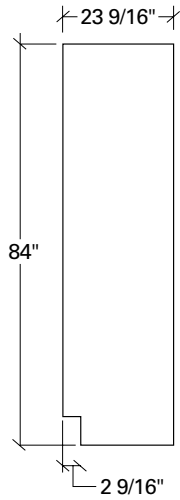
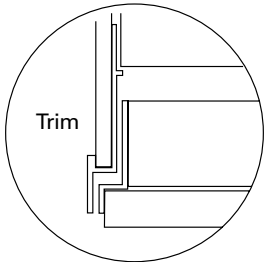

Standard 4" high toe-kick or trim to fit.
Height may vary depending on application.

1/2" to 3/4" Side
Panels Leading Edge
Flush with Cabinet
Front. The front or
leading edge must be
finished to match
cabinetry.

Top View

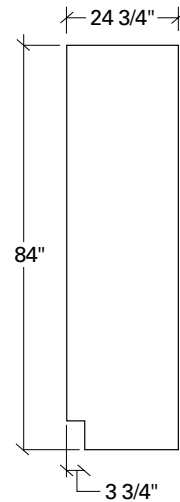
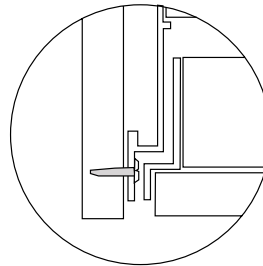

Standard 4" high toe-kick or trim to fit.
Height may vary depending on application.

1/2" to 3/4" Side
Panels Recessed
front edge.

Top View

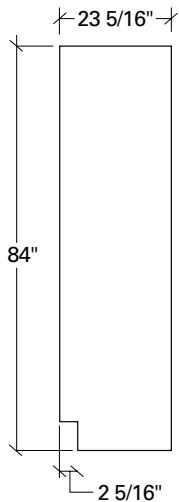
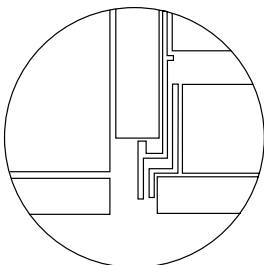

Standard 4" high toe-kick or trim to fit.
Height may vary depending on application.

For answers to your Monogram®,
GE Profile Performance Series™,
GE Profile™ or GE appliance questions, call
GE Answer Center® service, 800.626.2000.





Monogram™

ZIR36ND—GE Monogram 36" Built-In All-Refrigerator

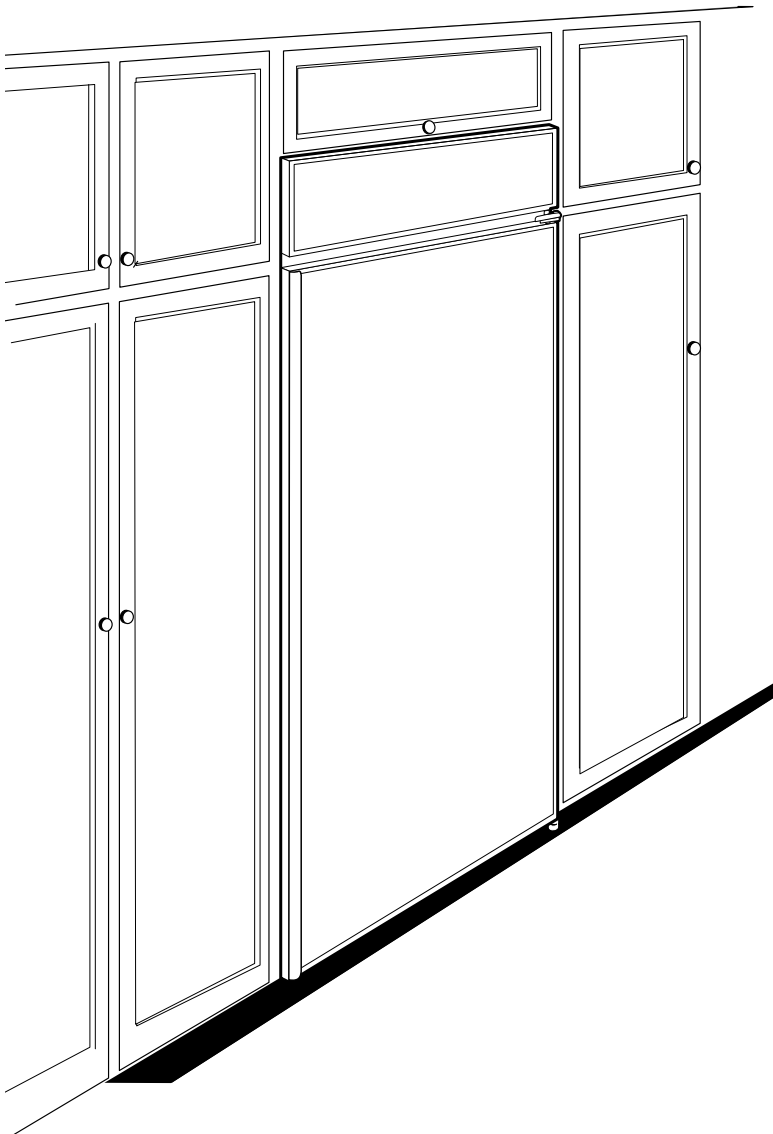

Features and Benefits

- 21.9 Cu. Ft. Fresh Food Capacity
- Spill Proof Glass Shelves (6 Adjustable, 1 Full-Width Fixed)
- Sealed Snack Pans with Full-Extension Slides
- 2 Extra Large Adjustable Humidity Produce Pans with Easy Access Lid and Full Extension Slides
- Wine Caddy
- 4 Large Wire Baskets with Full-Extension Slides
- 4 Door Bins with Gallon Storage
- 2 Sealed Dairy Compartments with Glass Covered Butter Dish
- Egg Bin
- Auto Cycle Defrost Sealed System Design
- Full Extension Accuride Slides
- Custom Panels Required
- Model ZIR36NDRH - Right hand door opening
- Model ZIR36NDLH - Left hand door opening