

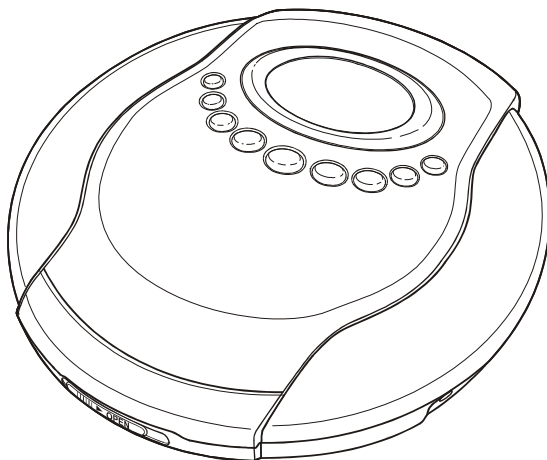

MP3 / CD PERSONAL PLAYER WITH DELUXE HEADPHONES

MODEL CD-965

OPERATING INSTRUCTIONS



- **PLAYS MUSIC CDs & MP3 ENCODED DISCS**
- **DISPLAYS TITLE OF SONG (if available)**
- **ELECTRONIC VOLUME CONTROL**
- **BASS BOOST SYSTEM**
- **60 SEC ESP PLUS™ ON CD PLAY**
- **120 SEC MP3 ANTI-SKIP ON MP3 PLAY**
- **FULLY PROGRAMMABLE PLAYBACK**
- **REPEAT 1 & REPEAT ALL PLAY**
- **INTRO & RANDOM PLAY**
- **USES 2 SIZE “AA” BATTERIES (NOT INCLUDED)**
- **LINE OUT JACK - CONNECTS TO YOUR STEREO SYSTEM**

PLEASE READ CAREFULLY BEFORE USE

IB-CD965(CDM32J-60F8)-WM-E-010504

LOCATION OF CONTROLS

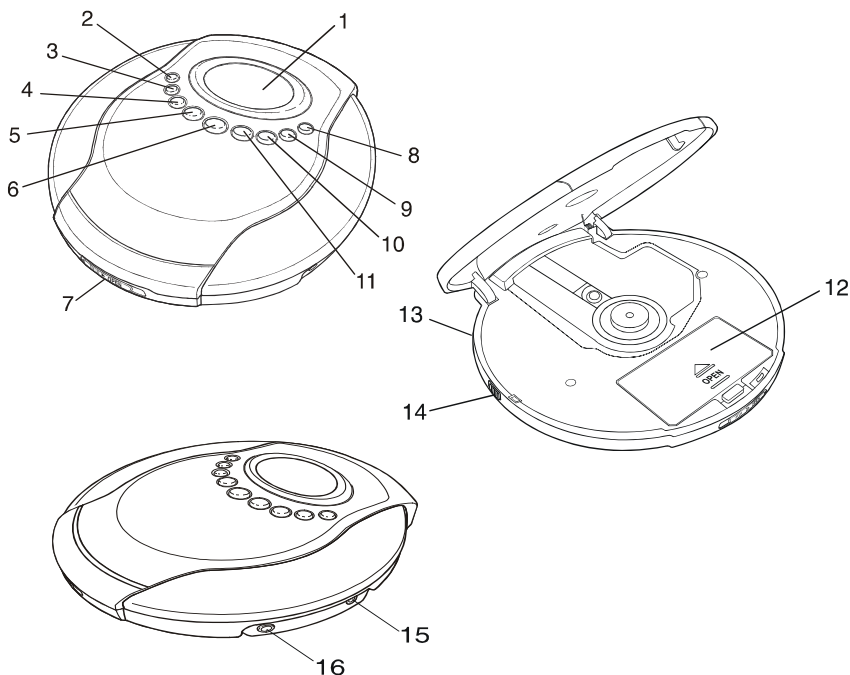

1. LCD DISPLAY
2. REPEAT BUTTON
3. 10+ / ALBUM BUTTON
4. BACKWARD SKIP/SEARCH BUTTON
5. FORWARD SKIP/SEARCH BUTTON
6. PLAY/PAUSE AND POWER ON BUTTON
7. CD DOOR OPEN BUTTON (slide to open)
8. VOLUME CONTROL (⊕) INCREASE
9. VOLUME CONTROL (⊖) DECREASE
10. EQUALIZER AND PROGRAM BUTTON (for programmed play)
11. STOP AND POWER OFF BUTTON
12. BATTERY DOOR
13. AC ADAPTOR JACK (DC 4.5V)
14. BASS BOOST SWITCH
15. LINE OUT JACK (for home stereo connection)
16. PHONES JACK (headphone jack)

POWER SOURCES

Power this player by inserting 2 size "AA" fresh alkaline batteries.

Using with Batteries

BATTERY OPERATION

1. Slide the OPEN button to open the CD DOOR, then open the BATTERY DOOR.
2. Insert 2 size "AA" fresh alkaline batteries as shown.
NOTE: Player will not work, and batteries will be drained, if not inserted as shown inside the Battery Compartment.
3. Close the BATTERY DOOR.

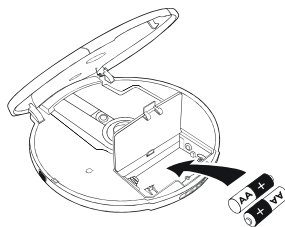

TIPS ON BATTERY USE

- Reversing polarities will damage the batteries and possibly your set. Be sure to follow polarity (+ and -) as indicated.
- Do not mix different types together (Alkaline, Carbon-Zinc, Nickel-Cadmium etc.), or old batteries with new ones.
- When not in use for an extended period of time, or while internal batteries will not be used, remove them to prevent possible acid leakage or corrosion resulting in damage to your player.
- When the batteries have become discharged, they must be disposed of in a safe manner that complies with all applicable laws.
- Installation of batteries should only be done by an adult (for safety).

ALKALINE BATTERY LIFE

Bear in mind that battery life expectancy is based upon volume and bass listening levels.

Maximum battery power consumption happens at maximum settings. Typical life for 2 size "AA" alkaline batteries is above 8 hours of continuous use for CD play.

WHEN SHOWS IN THE DISPLAY

If the alkaline batteries are weak and discharged, this symbol "" shows or flashes in the display, then the power automatically turns off. If this occurs, replace the alkaline batteries (also if the display does not show anything, the batteries are dead).

NOTE: You may use rechargeable batteries on this set. However, because rechargeable batteries generally have lower voltage (1.2 volts instead of 1.5 volts). Your playing time will be much less than normal fresh alkaline batteries.

AC Adaptor (optional)

You can also power this CD player by connecting an optional AC adaptor.

Before you buy an AC Adaptor, please note, the only AC ADAPTOR suitable for this player is DC 4.5V 700mA (or greater mA), with plus center polarity . Others may damage the player. Please check voltage & current (mA) before buying an AC ADAPTOR.

CONNECTING TO HOME STEREO SYSTEMS

The LINE OUT jack is made to accept a stereo mini plug (3.5mm). Simply connect the cable's mini plug to the LINE OUT jack on your player, and the other appropriate end usually RCA JACKS to the CD/AUX **INPUTS** of your home stereo.

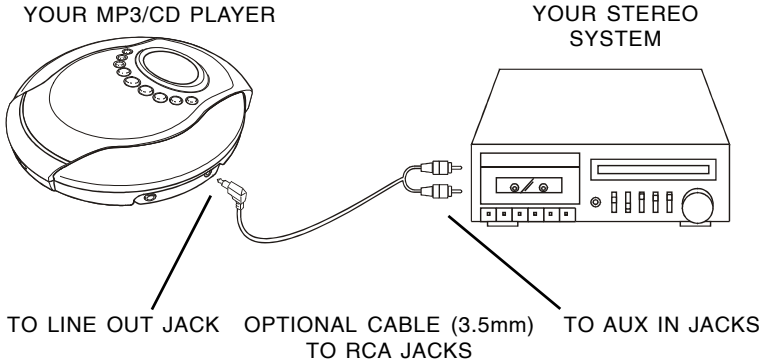

NOTE: Use the volume control of your stereo system to adjust the volume because the VOLUME buttons on this player have only a slight effect on the output level when used with the LINE OUT jack.

CD PLAYING

1 Load the Disc.

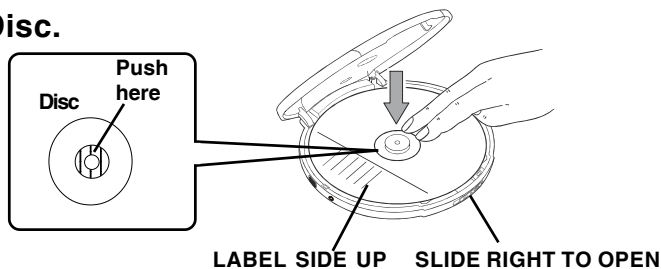

2 Connect the Headphones.



3 Press the PLAY/PAUSE Button.

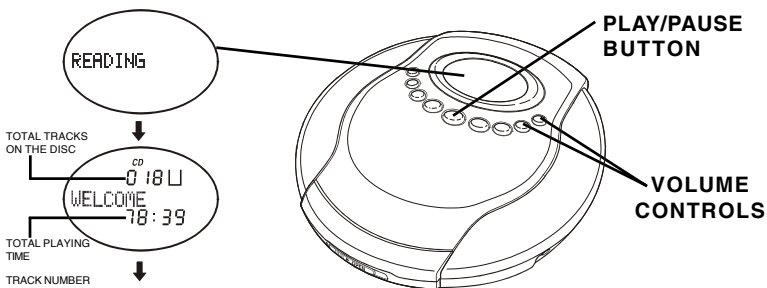

NOTE: The **ESP PLUS™** function will turn on automatically when the PLAY/PAUSE button is pressed.

NOTE: To turn off the **ESP PLUS™** function, press and hold the 10+ / ALBUM button for 2 or 3 seconds.

4 Adjust the Volume.

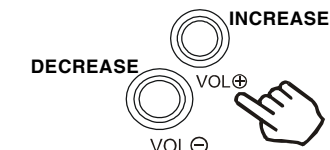

OTHER CD OPERATIONS (see Pages 9-13 for MP3 play)

Operation ● **Press** ● **Display window shows**

To pause play ● **PLAY/PAUSE button** ● **Display window shows**



TRACK NUMBER CURRENTLY PLAYING: 00 1
PLAYING TIME FLASHES: 02:38

To release pause and resume play ● **PLAY/PAUSE button** ● **Display window shows**

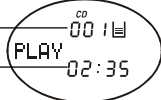

TRACK NUMBER CURRENTLY PLAYING: 00 1
PLAYING TIME ADVANCES: 02:35

To stop ● **STOP button** ● **Display window shows**

NOTE: PAUSE & PLAY will only show during CD play, not MP3 play.



TOTAL TRACKS: 018
TOTAL PLAYING TIME: 78:39

Get your set into **STOP mode** for PROGRAMMED play.

To turn off the power ● **STOP button once and wait 30 seconds, or press STOP button twice**

To skip to the next track(s) ● **SKIP/SEARCH FORWARD button**  once (or repeatedly)

To skip to the next track(s) quickly ● **10+/ALBUM button once (or repeatedly). Every time you press 10+/ALBUM button, the play will skip to the next 10th track or the end track of the disc.**

To skip to the previous track(s) ● **SKIP/SEARCH BACKWARD button**  once (or repeatedly)

To go ahead at high speed (search) ● **Keep SKIP/SEARCH FORWARD button**  depressed and release when the desired music section of the disc is found.

To go back at high speed (search) ● **Keep SKIP/SEARCH BACKWARD button**  depressed and release when the desired music section of the disc is found.

BASS BOOST switch

This switch enhances the low frequency (bass) sounds at low listening levels. Slide the BASS BOOST switch (at the left side of the set) ON or OFF to suit your taste.

EQUALIZER function

During play, you may select the tone type by pressing the EQ button to choose the tone type. The display will show what you selected: DBB, POP, CLASSIC, JAZZ, ROCK or NORMAL.

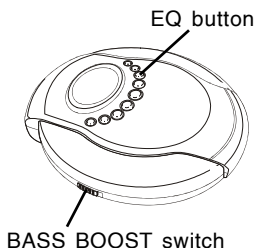

CD REPEAT, INTRO AND RANDOM PLAY

You may enjoy repeat, intro or random play using the REPEAT button.

During play or in stop mode, press the REPEAT button several times, and the display will show the following in turn:

REPT 1 --> REPT ALL --> INTRO --> RND --> NORMAL PLAY

Single Track Repeat (REPT 1)

Plays one song over and over till you press STOP.

During play, select the song you want to repeat with either of the SKIP/SEARCH buttons (◀◀ or ▶▶), then press the REPEAT button once, the symbol **REPT 1** appears in the display.

The song currently playing will repeat over and over, until you press STOP.

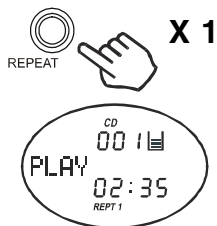

All Tracks Repeat (REPT ALL)

Plays all songs in order, then repeat, till you press STOP.

During play, press the REPEAT button twice, the symbol **REPT ALL** will show in the display.

All songs will keep playing in sequence 1, 2, 3, etc. and when finished, will start all over again until you press the STOP button.

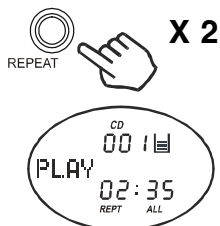

Intro Play (INTRO)

This plays the first 10 seconds of all songs in sequential order.

1. During play or in stop mode, press the REPEAT button 3 times, the word **INTRO** will flash in the display.
2. Press the PLAY button. The first 10 seconds of **each** song on the CD will play in sequential order.
3. When you find a song you like, press the PLAY button, normal play will be resumed, that song (and the following songs) will play **NORMALLY** until you press the STOP button.

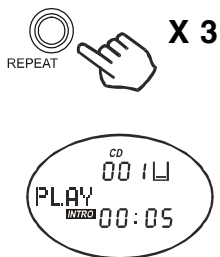

Random Play (RND)

This **shuffles** the songs on the disc in a random order.

1. During play or in stop mode, press the REPEAT button 4 times, the word **RND** will flash in the display.
2. Press the PLAY button, this will play all of the songs in random order selected by the CD player.
3. Press the SKIP/SEARCH button ▶▶ to skip to the next random song.
4. The set will play the songs in random order till you press the STOP button.

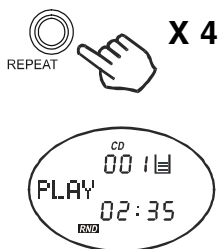

CD PROGRAM PLAY

The tracks (songs) on the disc can be programmed (arranged in advance) to play in any order you prefer (up to 20 tracks can be programmed).

Programming Example:									
Program Number	1	2	3	4	5	6	7	8	etc.
Track Number (song number)	2	5	8	1	2	4	1	1	etc.

During programming, the word **PROG** shows in the display. To program songs to play in your preferred order, follow steps below:

1. Press the PROGRAM button in **STOP** mode after the disc stops rotating.



The word **PROG** will show in the Display.

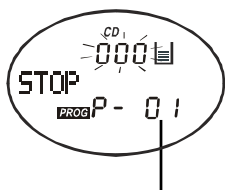

Program number

2. Press the SKIP/SEARCH button (◀◀ or ▶▶) to select track number 2 (example). Track number will flash in the display.

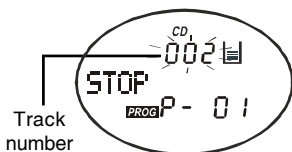

3. Press the PROGRAM button. Track 2 is now programmed.

Program number 2 will now show in the display, ready for your next selection of track.

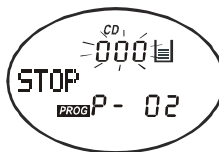

4. Repeat steps 2 and 3 to program other tracks till you finish (up to 20 selections).

5. After programming is finished, press the PLAY button to begin programmed play. Music begins with **PROG** shown in the display.



NOTE:

- The player will stop automatically after all programmed tracks have been played.
- To quit programmed play, press STOP button twice. Then you may press PLAY button to re-start normal play.

Your programmed memory will be lost:

- When the door is opened.
- When the batteries are exhausted or removed.
- When the power is off.

ESP PLUS™ ANTI-SKIP SYSTEM



This set is designed with the latest 60 second **ESP PLUS™** (Electronic Skip Protection) for CD play and 120 second for MP3 - which allows virtually unlimited gentle skip protection above the normal shock protection.





The **ESP PLUS™** function prevents the sound from skipping by using a buffer memory that stores music data. This new **ESP PLUS™** system can store more music than normal anti-skip systems.

This new design allows gentle swaying of the set (as in walking) without music skipping. This function may not work during heavy jogging.

The **ESP PLUS™** function will turn on automatically when the PLAY/PAUSE button is pressed.

When the PLAY/PAUSE button is pressed, the “” (memory basket) indicator will appear in the display, the digital data (music) is stored in the “read-ahead” memory buffer before it is decoded and played.

The “” mark changes to the “” mark, indicating that the memory buffer (basket) is full.

- If the set is subject to a shock or a bump during play, the data stored in memory continues to be decoded and played. This gives the pickup time to stabilize and continue reading new music. As the data is used from memory, the indicator changes from “” to “”. Once the pickup returns to its original position, new data is stored in memory and the display changes back to the “” mark.
- If the set is subject to repeated shocks and all the data stored in memory is used up, the “” mark is displayed and the sound will skip or stop for a brief period until the memory basket has time to fill up again.

NOTE:

- The music may stop if the player receives continuous shocking or shaking.
- You may hear noise or skipping if the DISC is dirty or scratched.
- During ESP play, if you press SKIP/SEARCH button, or 10+ / ALBUM button, the memory basket will empty itself temporarily in order to read ahead.

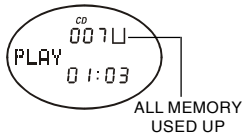
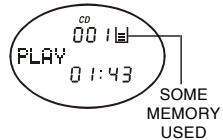
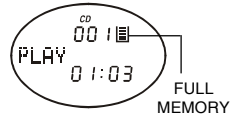
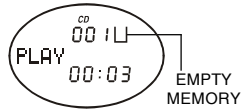

NOTE: During CD play, the **ESP PLUS™** function can be turned off or on if you press and hold the 10+ / ALBUM button for 2 or 3 seconds.

Basic Introduction to MP3

MP3 files are music files which have been compressed into the MP3 format. The CD-965 plays MP3 files which have been written onto a CD disc.

- The first thing you will need is an IBM compatible PC computer (at least Pentium class) or an apple computer (at least G3 class) with lots of RAM and a CD-R or CD-RW writer. Then you will need some software. (Either it is in your new computer already or you may have to buy this from MusicMatch or a similar company. You may go to the Website www.musicmatch.com or www.nero.com.
- To play MP3 files on this player, you will need to make (record) a disc with your MP3 files on them.
- We recommend you get some books or information on the Web to help you learn this exciting new way to store & play hundreds of songs in MP3 format. Also you may search the web for "MP3" and you will immediately find a world of information and songs.

NOTE: Most audio CD players can't play MP3 files, the CD-965 can play both MP3 and normal music files but not if they are mixed on one CD.

NOTE: This set will not play WMA music files.

- To download an MP3 file (song) from a website (like www.mp3.com), go to <http://www.mp3.com> and you can find a search link at the top of the homepage that allows you to search for MP3 files. Input a key word and click on that link and you will find many songs by many new artists. To download an MP3 file, click on software, then get MP3 link or newer software, register and click on download. We recommend you make a new folder for your MP3 files.
- You will also need blank CD's that are recordable, these are called CD-R or CD-RW (CD-R discs can be recorded on only once, CD-RW can be erased and rewritten or re-recorded but are more expensive.)
- This player will play most MP3 formats. Some formats (like WMA) or some non-standard sampling rates may not be supported or play.
- Successful recording of a CD needs an uninterrupted stream of high speed data. For best results, limit or close your other programs on the computer while recording to prevent buffer underruns or empty spots on the disc.
- You can play MP3 songs on most new computers or you can highlight them for downloading & "burning" (recording) them onto a CD later. Note your CD-965 will play MP3 songs which end in the extension ".MP3" (dot MP3 only). You can select how to save a file, select .MP3 as the correct extension on your computer. Do not save the file with other extensions like .txt)
- If you want to convert your existing records or tapes to MP3 discs, you will need to record them using a sound card. You will also need software such as MusicMatch or RealJukebox and a set of audio cables to connect your tape player to your sound card.
- If you want to record MP3 files from music CD's, first "rip" the music onto the hard disc. Ripping is much faster than recording.
- Titles and song names can be viewed by the text display of your CD-965. But in most cases above, you will need to enter the names of the songs. Also, if you put all songs in one album, it may be difficult for you to locate a particular song. We recommend several albums on a single CD with each album containing multiple songs. CDDb (www.cddb.com) is a database which can help you name songs and artists and has useful information on latest songs and artists.
- MP3 opens a whole new world of music to you. Learn about this exciting new format and enjoy.

MP3 PLAYBACK

1 Load your pre-recorded MP3 Disc.

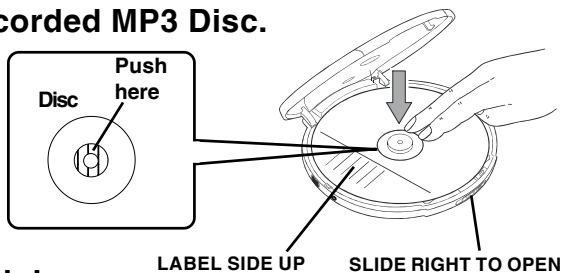

2 Connect the Headphones.



3 Press the PLAY/PAUSE Button.

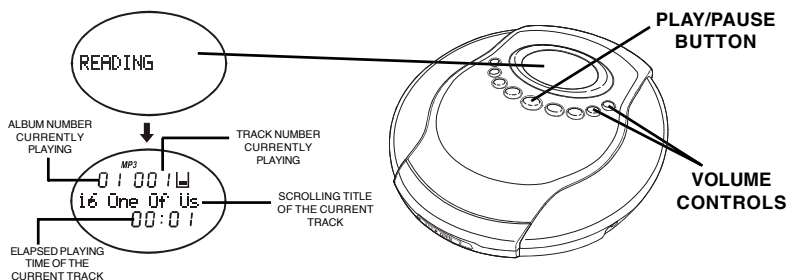

NOTE 1: The **ESP PLUS™** function will turn on automatically when the PLAY/PAUSE button is pressed.

NOTE 2: It may take 10 seconds to 30 seconds to fully read the disc depending on how many titles and songs are recorded on your MP3 disc (please be patient).

NOTE 3: If your MP3 disc was not made properly, the words "BAD MEDIA" or "BAD DISC" will show in the display.

NOTE 4: It is normal for the MP3 disc to stop rotating for a while after reading some data during play to conserve battery power. The music will continue, just the rotation will stop at times.

4 Adjust the Volume.

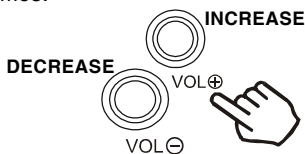

OTHER MP3 OPERATIONS

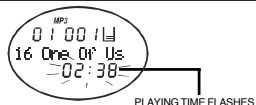
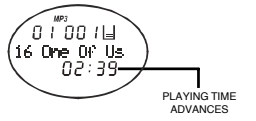
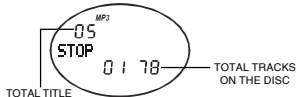
Operation	Press	Display window shows
To pause play	PLAY/PAUSE button	
To release pause and resume play	PLAY/PAUSE button	
To stop	STOP button	
To turn off the power	STOP button once and wait 30 seconds, or press STOP button twice	
To skip to the next track(s)	SKIP/SEARCH FORWARD button ▶▶ once (or repeatedly)	
To skip to the next track(s) quickly	10+/ALBUM button once (or repeatedly), every time you press 10+/ALBUM button, the play will skip to the next 10th track or the end track of the title.	
To skip to the previous track(s)	SKIP/SEARCH BACKWARD button ◀◀ once (or repeatedly)	
To go ahead at high speed (search)	Keep SKIP/SEARCH FORWARD button ▶▶ depressed and release when the desired music section of the disc is found.	
To go back at high speed (search)	Keep SKIP/SEARCH BACKWARD button ◀◀ depressed and release when the desired music section of the disc is found.	
To change the ALBUM	Press and hold the ALBUM button for 2 seconds until the album number flashes in the display, then press SKIP/SEARCH BACKWARD button ◀◀ or SKIP/SEARCH FORWARD button ▶▶ to choose the album. Press PLAY to start the selected album play.	

General Information

1. Usually, you must “write” your own MP3 disc on your computer’s CD writer. Or, you may buy pre-recorded MP3 discs from “on line” sources.
2. When saving songs (audio files) onto your CD-R (or CD-RW), you must save them as “.MP3” (DOT MP3) files. Do not save them as .DOC, .TEXT or .PDF etc when downloading, converting or saving files as MP3 files.
3. Do not save TEXT files as “.MP3” files because they will not play and they may interfere with the set.
4. Do not attempt to combine normal CD audio tracks and MP3 tracks onto one CD because the set will only recognize the audio tracks and only play those.

MP3 REPEAT, INTRO AND RANDOM PLAY

You may have repeat, intro or random play using the REPEAT button.

During play or in stop mode, press the REPEAT button several times, and the display will show the followings in turn:

REPT 1 --> REPT DIR --> REPT ALL --> INTRO --> SHUFF --> NORMAL PLAY

Single Track Repeat (*REPT 1*)

Plays one song over and over till you press STOP.

During play, select the song you want to repeat with either of the SKIP/SEARCH buttons (**◀** or **▶**), or the 10+/ALBUM button, then press the REPEAT button once, the symbol **REPT 1** appears in the display.

The song currently playing will repeat over and over, until you press STOP.

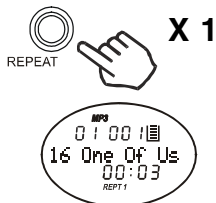

All Tracks Repeat (*REPT DIR*)

Repeats all single album songs in order, till you press STOP.

During play, select the title you want to repeat with either of the SKIP/SEARCH buttons (**◀** or **▶**), or the 10+/ALBUM button, then press the REPEAT button twice, the symbol **REPT DIR** will show in the display.

All songs of that title or album will keep playing in sequence 1, 2, 3, etc. and when finished, will start all over again until you press the STOP button.

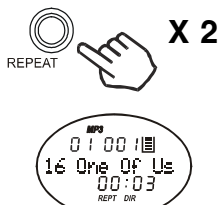

All Tracks Repeat (*REPT ALL*)

Repeats all songs in order, till you press STOP.

During play, press the REPEAT button 3 times, the symbol **REPT ALL** will show in the display.

All songs on the disc will keep playing in sequence 1, 2, 3, etc. and when finished, will start all over again until you press the STOP button.

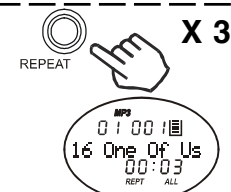

Intro Play (*INTRO*)

This plays only the first 10 seconds of songs in sequential order.

1. During play or in stop mode, press the REPEAT button 4 times, the word **INTRO** will flash in the display.
2. Press the PLAY button, the first 10 seconds of **each** song on the disc will play in sequential order.
3. When you find a song you like, press the PLAY button. Normal play will be resumed, that song (and the following songs) will play **NORMALLY**.

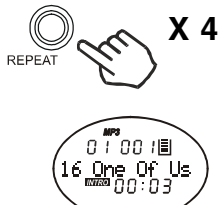

Random Play (*RND*)

This **shuffles** the songs on the disc in a random order.

1. During play or in stop mode, press the REPEAT button 5 times the word **RND** will flash in the display.
2. Press the PLAY button, this will play all of the songs in random order selected by the MP3/CD player.
3. Press the SKIP/SEARCH button **▶▶** to skip to the next random song.

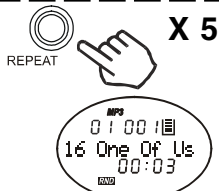

MP3 PROGRAM PLAY

The tracks (songs) on the disc can be programmed (arranged in advance) to play in any order you prefer (up to 64 tracks can be programmed).

Programming Example:									
Program Number	1	2	3	4	5	6	7	8	etc.
Album Number (title number)	2	1	3	4	5	2	1	3	etc.
Track Number (song number)	3	5	8	1	2	4	5	6	etc.

During programming, the word **PROG** shows in the display. To program songs to play in your preferred order, follow steps below:

1. Press the PROGRAM button in **STOP** mode.



The word **PROG** will show in the display and the title or album number will flash.

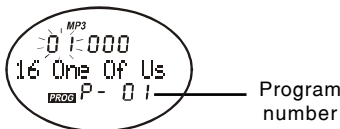

2. Press the SKIP/SEARCH button (◀◀ or ▶▶) to select title number 2 (example).

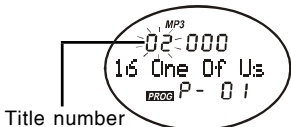

3. Press the PROGRAM button. Title 2 is now selected, and the display shows:



4. Press the SKIP/SEARCH button (◀◀ or ▶▶) to select track number 3 (example).

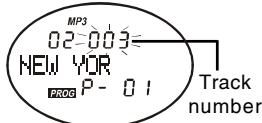

5. Press the PROGRAM button. Track 3 is now programmed. Program number 2 will now show in the display, ready for your next selection of track.

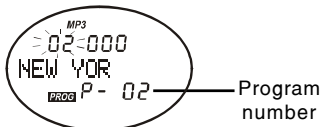

6. Repeat steps 2 to 5 to program other tracks till you finish (up to 64 selections).
7. After programming is finished, press PLAY to begin programmed play. Music begins with **PROG** shown in the display.

NOTE:

- The player will stop automatically after all programmed tracks have been played.
- To quit programmed play, press the STOP button twice. You may press the PLAY button to re-start normal play.

Your programmed memory will be lost:

- When the door is opened.
- When the batteries are exhausted or removed.
- When the power is off.

MAINTENANCE

Cleaning the lens

A dirty lens will cause sound skipping. If the lens is very dirty, the player may not work. We suggest using a special cleaning disk (not included) available in most music and Hi-Fi stores. However, if you do not have one, you may use a cotton swab very slightly dampened with alcohol to clean the lens.

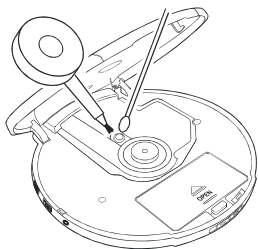

Cleaning the cabinet

Wipe with a soft cloth. If the cabinet is very dirty, dampen (not dripping wet) the cloth with a weak solution of soapy water, and then wipe clean.

Cleaning the Discs

- Fingerprints should be carefully wiped from the surface of disc with a soft cloth. Unlike conventional records, compact discs have no grooves to collect dust and microscopic dirt, so gently wiping them with a soft cloth should remove most particles. Wipe in a straight motion from the center to the edge.

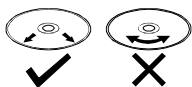
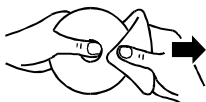

- Never use thinner, benzene, record cleaner or antistatic spray on a compact disc. Such chemicals can damage its plastic surface.

Handling Compact Discs

- Dirty, scratched or warped discs may cause skipping or noise.
- Handle the disc only by the edges. To keep clean, do not touch its surface.



- Discs should be stored in their cases after use to avoid scratches.
- Do not expose discs to direct sunlight, high humidity, high temperatures, or dust, etc. Prolonged exposure to extreme temperatures can warp the disc (such as leaving the discs in your car during summertime).
- Do not stick or write anything on either side of disc. Sharp writing instruments, or the inks used in some felt-tip pens, may damage its surface.

To remove the Disc

Open the CD DOOR by sliding the **CD DOOR OPEN** button, hold the disc by the edge while slightly pressing on the center spindle as illustrated, then lift it from the edge to release and remove.

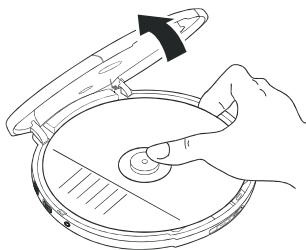

NOTE

Always press STOP button and wait for the disc to stop rotating before sliding the CD DOOR OPEN button to remove the disc.

SAFETY PRECAUTIONS

Do not take the set apart. The laser beam used in the set may harm your eyes. Refer servicing to qualified service personnel only.

Do not insert pins or coins, clips, or any objects inside the set.

This set is equipped with a safety device which automatically turns the laser beam off when the CD DOOR is opened.

Do not drop the set or subject it to strong shocks. Doing so could result in damage.

Do not place the set in locations where the temperature is high, or in humid or dusty locations, or locations with long heavy vibrations, or tilted surfaces.

The set's cabinet may warp or the set may be damaged if it is placed in direct sunlight, near heaters (where the temperature is 140°F/60°C or higher) or in cars with the windows closed. In the summer, the temperature may get as high as 212°F/100°C or more.

Use the set within a temperature range of 41°F/5°C to 95°F/35°C.

Use ONLY the optional DC 4.5V 700mA AC ADAPTOR with plus center polarity , others may damage your set. Disconnect the ADAPTOR from the wall outlet when the set is not to be used for an extended period of time (3 days or more).

When cleaning your set, use a soft dry cloth. Do not use solvents or commercially available cleaners, as they may damage or discolor the finish.

Do not wear headphones while operating a motor vehicle. This could create a traffic hazard and is illegal in many areas. Do not use this set when bicycling or running.

The headphones supplied with your set provide superb stereo listening while allowing you to hear some outside sounds when listening at normally low volume levels. Listening at extremely high volume levels minimizes the intrusion of outside noise/sounds. In the interest of safety, it is strongly advised against the use while engaging in activities where the exclusion of external sounds (whistles, horns, sirens, traffic, etc.) could be hazardous. Also loud volume can hurt your ears. Discontinue use or lower the volume. If you notice that the sound has become weak or distorted or if tracks do not change, this is an indication that your batteries are weak. Replace both batteries at the same time (see Using with Batteries).

Your CD-965 is identified by a serial number located on the bottom of the set. Record this number in the space provided below.

Model CD-965

Serial No.

Date Purchased:

This manual contains detailed information on its safety and use. Please read it carefully so that you may take full advantage of its many features, and ensure a safe reliable operation. Keep this manual for future reference.

CONDENSATION

If cold water is poured into a glass, water droplets form on the outside of the glass. This is called condensation. Condensation may occur on internal operating parts of the lens.

Condensation occurs:

When the set is brought from the cold outdoors into a warm room, or if it is in a cold room to a room which is heated, or in the summer, if the set is moved from an air-conditioned room or car to a hot or humid location.

Should condensation occur, the set may not operate properly. Open the CD DOOR and wait for about 20 minutes (to allow the internal parts to adjust to the surrounding temperature) before using the set.

IMPORTANT REQUIREMENT BY THE FCC

Since the CD circuitry may cause interference to other radios nearby, switch this set off when not in use or move it away from the affected radios.

This device complies with Part 15 of the FCC Rules. Operation is subject to the following two conditions: (1) This device may not cause harmful interference, and (2) This device must accept any interference received, including interference that may cause undesirable operation.

NOTE: This equipment has been tested and found to comply with the limits for a Class B digital device, pursuant to Part 15 of the FCC Rules. These limits are designed to provide reasonable protection against harmful interference in a residential installation. This equipment generates, uses and can radiate radio frequency energy and, if not installed and used in accordance with the instructions, may cause harmful interference to radio communications. However, there is no guarantee that interference will not occur in a particular installation. If this equipment does cause harmful interference to radio or television reception, which can be determined by turning the equipment off and on, the user is encouraged to try to correct the interference by one or more of the following measures:

- Reorient or relocate the receiving antenna.
- Increase the separation between the equipment and receiver.
- Connect the equipment into an outlet on a circuit different from that to which the receiver is connected.
- Consult the dealer or an experienced radio/TV technician for help.

SAFETY CERTIFICATION

This Compact Disc Player is made and tested to meet safety standards of the FCC requirements and comply with safety performance of the U.S. Department of Health and Human Services, and also with FDA Radiation Performance Standards 21 CFR Subchapter J.

WARNING

To prevent fire or shock hazard, do not expose this appliance to rain or moisture.

LASER SAFETY

THIS SET EMPLOYS AN OPTICAL LASER BEAM SYSTEM IN THE CD MECHANISM, DESIGNED WITH BUILT-IN SAFEGUARDS. DO NOT ATTEMPT TO DISASSEMBLE. EXPOSURE TO THIS INVISIBLE LASER LIGHT BEAM MAY BE HARMFUL TO HUMAN EYES. THIS IS A CLASS-1 LASER PRODUCT. USE OF ADJUSTMENTS OTHER THAN THOSE SPECIFIED HEREIN, MAY RESULT IN HAZARDOUS LASER LIGHT BEAM EXPOSURE. THIS COMPACT DISC PLAYER SHOULD NOT BE ADJUSTED OR REPAIRED BY ANYONE EXCEPT QUALIFIED SERVICE PERSONNEL. THE LASER MECHANISM IN THE SET CORRESPONDS TO THE STYLUS (NEEDLE) OF A RECORD PLAYER. ALTHOUGH THIS PRODUCT USES A LASER PICK-UP LENS, IT IS COMPLETELY SAFE WHEN OPERATED ACCORDING TO DIRECTIONS.

TROUBLE SHOOTING GUIDE

Symptoms	Causes	Solutions
Tracks do not change or set does not play normally.	Batteries are weak (they may test OK on tester but they are weak for MP3/CD operation).	Replace both batteries with fresh alkaline batteries. Battery life with fresh batteries is above 8 hours (rechargeable batteries have 1/2 of that life).
MP3/CD Player will not turn on.	Dead or weak batteries.	Replace both batteries with fresh ones.
	The optional AC ADAPTOR not connected properly.	Check AC ADAPTOR connection at AC outlet and the rear of the set.
Disc will not play.	Disc inserted incorrectly.	Re-insert disc with label side facing up.
	Defective compact disc.	Try another compact disc.
	CD DOOR not closed.	Close the door securely.
	Moisture has formed inside the CD deck.	Take out the disc and leave the CD Door open for about 20 minutes to dry the moisture condensation.
No sound from headphones.	Headphone plug not inserted properly.	Re-insert headphone plug into PHONES jack (not LINE OUT).
	VOLUME control set to minimum.	Increase the volume.
	Weak batteries.	Replace with fresh batteries or use an optional AC ADAPTOR.
	Defective compact disc.	Try another compact disc.
VOLUME control has less function.	Headphones plugged into LINE OUT jack.	Plug headphones into PHONES jack. (NOT THE LINE OUT JACK)
Sound is skipping or sound stops.	The disc or lens is dirty or is scratched.	Clean or replace the compact disc or clean the lens.
	Strong vibrations.	Place the player on a stable level.
Sound is distorted.	Music is too loud.	Lower the VOLUME control.
	BASS BOOST is ON .	Slide BASS BOOST switch to OFF .
	Weak batteries.	Replace both batteries or use an optional AC ADAPTOR.
Buttons do not work.	Electronic or static error caused circuitry to lock.	Remove batteries and the optional AC ADAPTOR. Wait 15 seconds and re-insert. Make sure batteries are fresh or the optional AC ADAPTOR has power.
MP3 playback does not work or stops.	A transfer error in the burning process when the MP3 was burned from a computer.	Re-burn a fresh MP3 disc from your computer, test it on your computer first.
	MP3 songs were not recorded properly.	Re-record a new MP3 disc.

TECHNICAL SPECIFICATIONS

MP3/CD Section

Frequency response	50Hz-15kHz +1/-2dB
Sampling frequency	44.1kHz
D/A converter	1-bit
Error correction method	CIRC
Pickup	Optical 3-beam semiconductor laser (780 nm wavelength)
Laser diode material	GaAlAs
Laser output	less than 44.6 μ w

NOTE: CD-R/CD-RW disc playing capability of this CD/MP3 player may vary depending on quality of media CD-Burner and application software.

General

Maximum output (stereo headphones) 20mW + 20mW

Power Supply

AC adaptor	4.5V, 700mA, 120V/60Hz (not included)
DC	3V: Using 2 size "AA" batteries (not included)

Set Dimensions (approximate)

Width	5 1/4 "
Depth	5 3/4 "
Height	1 "

Weight (approximate) 270g (set only)

Because the products are subject to continuous improvement, Lenoxx reserves the right to modify product designs and specifications without notice and without incurring any obligation.

LIMITED WARRANTY

We warrant this product to be free from defects in material and workmanship under normal use for a period of 90 days after purchase and we will repair it free of charge or replace it at no charge, should it become defective under this warranty, providing you submit proof of purchase (sales slip) with the set.

During the initial 90 day period after original purchase, we will service or exchange, at no charge, the set that is returned to LENOXX ELECTRONICS CORP. After the initial 90 day period expires, and for a period of 12 months from original purchase, we will repair the unit covering any part(s) that need to be replaced at no charge, but will charge for the cost of labor, return postage paid by Lenoxx.

This warranty does not apply to any products which have been subject to misuse, neglect or accident. This warranty does not cover broken headphones or cabinet. UNDER NO CIRCUMSTANCES WILL LENOXX ELECTRONICS CORP. BE LIABLE FOR ANY INCIDENTAL OR CONSEQUENTIAL DAMAGES. Some states do not allow the exclusion or limitation of incidental or consequential damages, so the above limitations or exclusions may not apply to you.

This warranty gives you specific legal rights, and you may also have other rights which vary from state to state. The following charges apply to repairs beyond the warranty period: \$15.00. Be sure to pack carefully and return postage paid insured together with your money order (personal checks will not be accepted) and sales receipt to:

LENOXX ELECTRONICS CORP., 2 GERMAK DRIVE, CARTERET N.J. 07008

For customer service Dial: 1-800-315-5885

(MONDAY - THURSDAY 09:00 AM - 05:00 PM, FRIDAY 09:00 AM - 01:00 PM EST)

<http://www.lenoxx.com>

© 2004 LENOXX ELECTRONICS CORP.
2 GERMAK DRIVE
CARTERET, N.J. 07008
MADE & PRINTED IN CHINA