

# INSTALLATION AND OPERATION MANUAL

## X-3 LCG RECORDER

### COMMAND SUMMARY

DIGITAL OFF/ON	2nd-5
DIGITAL #'s SIZE	2nd-2
AUTO RANGING OFF/ON	2nd-8
HIGH-SPEED Scroll ON/OFF	2nd-4
CLEAR ENTRY	2nd-0 or 2nd-2nd
CLEAR SCREEN	2nd-0-0
FREEZE CHART	STOP/RESUME
RESTART CHART	STOP/RESUME
DISCRIMINATION	0, 1, or 2-DISC
AUTO-RANGING W/ZOOM BOTTOM TRACK	WINDOW SIZE-2nd-8
INCREASE SENSITIVITY	PRESS > KEY
DECREASE SENSITIVITY	PRESS < KEY
INCREASE CHART SPEED	PRESS FAST KEY
DECREASE CHART SPEED	PRESS SLOW KEY
VIEW CHART SPEED WITHOUT CHANGING	PRESS 2nd-FAST or SLOW
TURN OFF/ON AUTO SENSITIVITY	PRESS AUTO KEY
TURN ON/OFF LIGHTS	2nd-9
FEET-FATHOMS-METERS	2nd-6
CHART ALARM SET	SELECT-SHALLOW SET or DEEP SET- UP ARROW or DOWN ARROW TO ADJUST DEPTH
DEPTH ALARM SET	SELECT-SHALLOW ALARM DEPTH- SHALLOW SET-DEEP ALARM DEPTH- DEEP SET
CLEAR ALARM	2nd-0-SELECT
TURN ALARM SPEAKER OFF/ON	NOTE KEY



**LOWRANCE ELECTRONICS, INC.**  
12000 E. SKELLY DR., TULSA, OKLA. 74128

## INDEX

Installation	2
Power Connections	3
BASIC OPERATION	4
OFF/ON	4
Sensitivity	5
Chart Speed	7
Clear	8
Range	8
Auto Range	8
Scale	9
Lower Limit	9
Upper Limit	10
Digital	11
ALARMS	13
Chart Alarm	14
Clearing Chart Alarm	15
Depth Alarm	15
Clearing Depth Alarm	16
Light	17
Discrimination	17
ADVANCED OPERATION	18
High Speed Scroll	18
FASTRAK	19
Feet-Fathoms-Meters	20
Auto Range with Zoom Bottom Track	21
Auto Sensitivity	22
Other Tips	22
Transducers and Cone Angles	23
Signal Interpretation	24
Fish Signals	25
Surface Clutter	27
Water Temperature and Thermoclines	27
Surveying a Lake	29
Bait Fish	29
Troubleshooting	30
Specifications	31
How to Obtain Service	32
Schematic Diagram and Parts List	32
SHALLOW Water Operation	34

### SHALLOW WATER OPERATION

In very shallow water, (less than eight feet) the LCG may operate better with the automatic and digital functions turned off.

The easiest way to do this is to press



Next, select a depth range.

If the sensitivity is too high, press



Selecting the high speed scroll feature not only gives a high chart speed, but also turns off the digital sonar, auto sensitivity, and auto ranging. If a slower chart speed is desired, press the 2nd key and then the 4 key again. This will turn off the High Speed Scroll mode, however the automatic sensitivity, auto ranging and digital function will remain off.

The sensitivity is too high if the screen appears black, obscuring the bottom signal.



Range: 20 to 40 feet  
 Discrimination: Level 1  
 High Speed Scroll: On  
 Sloping Bottom, Large Fish from 22 to 34 feet

Range: 5 to 40 feet    Large Fish on Bottom  
 Fish at 19 feet  
 Surface Clutter Extends to 15 feet



## INTRODUCTION

The Lowrance X-3 Liquid Crystal Graph (LCG) is a compact unit that packs more power and features than any other sonar using a liquid crystal display (L.C.D.).

The L.C.D. sets the X-3 apart from other sonar units. Instead of a stylus writing on chart paper or a flashing neon light, the X-3 displays the depth information on a screen using small squares which turn black when an echo is received. As each echo is detected, the signals move across the screen, leaving behind a record of the area that was just passed.

No other sonar has as many automatic features as the X-3. Once turned on, it will find and display the bottom signal, fish, and other targets. As the depth of the bottom changes, the X-3 will automatically change the range, sensitivity, and other controls so that the bottom will always be displayed on the screen. If desired, the only key on the keyboard that needs to be touched is the off/on key.

However, the X-3 has built in override capability that allows the features to be used in any combination to best suit local conditions.

The X-3 is nitrogen filled and sealed for complete waterproof protection of the internal parts. The liquid crystal display and keyboard are back-lighted for easy use at night, and the X-3 is fully covered by a one year Lowrance full warranty which covers all parts and labor for one year from date of purchase.

## INSTALLATION

The X-3 may be installed in any convenient location, provided it can be tilted for the best viewing angle. Holes in the bracket base allow wood screw or thru bolt mounting. The bracket may be attached to aluminum panels with sheet metal screws, however, a piece of plywood may be required on the back of thin fiberglass panels to secure the mounting screws. Stainless steel is recommended for all mounting hardware. Make certain there is enough room behind the unit to attach the power and transducer cables.

A 7/8" hole is in the base of the gimbal bracket that allows the power and transducer cables to be routed straight down through the mounting surface. The smallest hole that will pass one connector thru is 3/4". This will allow the transducer connector and cable to be passed up through the hole and gimbal bracket, then the power cable wire can be pushed down thru the bracket and dash. After the cables have been routed, the hole may be filled with silicone rubber adhesive (RTV), or the bracket can be offset so that the majority of the hole is covered.

## POWER CONNECTIONS

Twelve volt DC power should be supplied by the boat's electrical system. The power cable may be attached to an accessory or power buss, but if you have problems with electrical interference (random dots or lines that show whenever the boat's engine or other accessory is on), the cable should be attached directly to the battery.

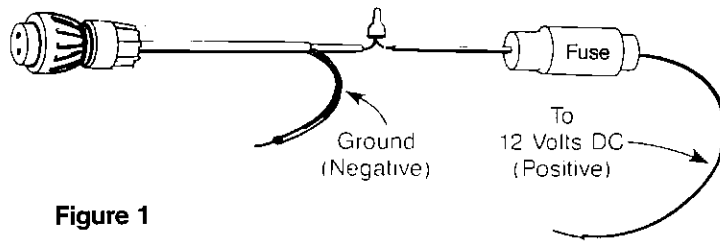

Figure 1

The power cable has two wires, red for the positive lead and black is ground or negative. An in-line fuse holder containing a 3 amp fuse is supplied with the X-3. This should be attached to the red wire on the power cable with the crimp connector. The other end of the fuse holder should be attached to the battery or accessory buss. If the cable is not long enough, splice ordinary #18 lamp cord to reach. Just be certain that the fuse holder is as close to the power source (battery or accessory buss) as possible. This will protect the power cable and unit in the event of a short. The X-3 is protected from accidental polarity reversals and will not be harmed if the wires are reversed. (However, the unit will not work until the proper polarity is applied.)

Electrical noise picked up by the power cable can be minimized by routing it away from other possible sources of electrical interference. One of the largest noise generators is the engine's wiring harness that runs from the engine to the boat's instrument panel. This harness usually contains a wire for the tachometer which radiates RF (radio frequency) energy. For the best results, keep the power and transducer cables away from the engine wiring. Bilge pumps are also noisy, so try to keep the X-3's cables away from them, too.

VHF radio antenna's coax cable radiate RF energy at higher power levels than even the engine's wiring harness. It is very important to keep the X-3's power and transducer cables as far away as possible from the VHF radio's antenna cable.

## HOW TO OBTAIN SERVICE

If you have a problem with your sonar unit, please give us a chance to help before sending it in for repair.

Assistance can often be extended by telephone or letter. Write or call one of our Authorized Service Centers or the Lowrance Customer Service Department in Tulsa, OK.

If you live out of the state of Oklahoma, call 1-800-331-3889, toll free.

If you live in the state of Oklahoma, call collect 918-437-6881.

Please detail the problem you are experiencing. Our Service Department may be able to save you the inconvenience of returning your unit.

If it is determined that your unit must be returned, full shipping instructions will be provided.

## SCHEMATIC DIAGRAM AND PARTS LIST

Should you desire a schematic and parts list for your Lowrance sonar, send \$1.00 to the address below and it will be mailed to you promptly. Please be sure and give us the model and serial number of your Lowrance sonar unit.

Mail To: Lowrance Electronics  
12000 E. Skelly Dr.  
Tulsa, Oklahoma 74128

## SPECIFICATIONS

Dimensions	5 $\frac{3}{4}$ "H x 8 $\frac{3}{16}$ "W x 2 $\frac{5}{8}$ "D
Weight	1 $\frac{3}{4}$ pounds
Transmitter	192 kHz
Output Power	600 watts peak to peak typical 75 watts RMS
Receiver Sensitivity	> 90 db
Operating Current	200 ma (lights off) 500 ma (lights on)
Operating Voltage	9-15 vdc
Number of pixels	82 x 32 2624 Total
Depth Capability	300'-500' typical (with 20 degree transducer)  500'-700' typical (with 8 degree transducer)
Display Scroll Speed	.5" per minute (minimum, normal mode) 8" per minute (maximum, normal mode) 32" per minute (High Speed Scroll)
Temperature (operating)	0 degrees C to +60 degrees C +32 degrees F to 140 degrees F
Temperature (storage)	-40 degrees C to +80 degrees C -40 degrees F to +176 degrees F

## BASIC OPERATION

When first turned on, the X-3 automatically adjusts the sensitivity, range, and chart speed according to water and bottom conditions. In fact, it can be left in this mode and it will track the bottom and display it at all times, automatically changing the range as the bottom depth varies. The sensitivity will also change as required, to keep the bottom signal displayed. If present, fish or other targets may be seen. At first, operate the X-3 in the automatic mode only. Just turn it on and watch it work. Then, read the following chapter on the X-3's basic operation and learn how to adjust it for your specific needs. Later, read the Advanced Operation section to make the most out of the X-3's remarkable capabilities.



### OFF/ON

The off/on key is in the lower right hand corner of the keyboard. It was placed in this location so that it would be easy to find—even at night.

### Turning power on

To turn the X-3 on, press the off/on key. (Note: the unit will beep every time a key is pressed. This is how the X-3 signals that an entry on the keyboard has been made.) The chart lights will begin flashing, then turn themselves off after six seconds. A message (see figure 4) will be displayed and the number "0" will flash. This number is the digital bottom depth display. After the unit has found the bottom, the depth will be shown in the display, proper sensitivity and range will be selected, and return echoes from the bottom, fish, or other targets will begin scrolling across the display.

### Turning power off

To turn the X-3 off, press and **HOLD** the off/on key until the display is erased. This may take several seconds. The unit will beep continuously until you release the off/on key. Remember, you must hold the Off/On key down until the screen is erased. If you don't hold it for several seconds, the unit won't turn off.

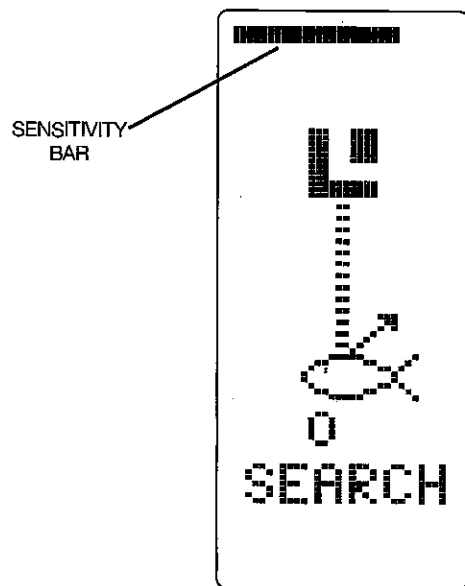

Figure 2



## SENSITIVITY

When first turned on, the X-3 is in the AUTO SEARCH mode. This means the sensitivity and range are being automatically adjusted by the micro-computer to find and lock onto the bottom.

The sensitivity can be left in the automatic mode, or it can be manually adjusted higher or lower to suit conditions.

The sensitivity level settings are displayed by a horizontal bar at the top of the display. See Figure 2. When the sensitivity is at minimum, the bar is very short. As sensitivity is increased, the bar will travel to the right, increasing in length corresponding with the higher sensitivity setting. When the sensitivity is set to maximum, the bar will run completely across the top of the display from left to right.

The AUTO key at the top middle position on the keyboard turns auto sensitivity off and on. Press it once, and auto sensitivity is turned off. Press it again, and auto sensitivity will be turned on. The auto annunciator is below the sensitivity bar, and can be seen when the auto sensitivity is on.

## TROUBLESHOOTING

If the unit works properly when stopped or at low speeds, but loses the bottom signal at high speed, the transducer could be improperly installed. Read the transducer installation manual for the correct mounting procedure.

If the transducer is installed properly, then electrical interference could be the cause. Double check the installation, particularly the power and transducer cable routing. Make certain that they are away from the engine wiring or other wiring harnesses, especially the tachometer wiring.

Should the display "freeze", check to see if the top line of the display or the digital bottom depth is flashing. If it is, then the unit is working, but the digital has lost the bottom signal, and it is trying to find it. The chart stops scrolling when the digital loses the bottom. It will start moving again when the digital regains the bottom. If neither the top line of the display nor the digital bottom depth is flashing and the chart won't scroll, then turn the unit off and back on again. The unit should begin working normally. If it can't find the bottom signal, and you are in shallow water, (less than eight feet) following the directions on page 24 concerning shallow water operation may help.

If the unit doesn't turn on when the ON/OFF key is pressed, then check the fuse or battery connections for tightness or corrosion.

Fish signals, especially in shallow water, do not always arch, but appear as irregularly shaped marks. Fish arches are most likely seen in 40 feet or deeper water, using a zoom range (for example 40 to 60 feet). Read the section "Fish Signals" on page 25.

If the unit will not turn off, remember that you should press and HOLD the ON/OFF key down until the display goes blank. If you don't hold the key down, the unit won't turn off.

On rare occasions and in certain installations, electrical interference could cause the LCG to display random information on the screen or the keyboard may not function properly. (For example, pressing the ON/OFF key will not turn the unit off). To restore it to working order, first try pressing 2nd-0-0. This should clear the screen. If this doesn't work, simply unplug the power cable from the back of the unit, plug it back in, and turn it on.

## SURVEYING A LAKE

The most successful anglers on any lake or reservoir are those who fish it day after day and year after year until they learn the hot spots that produce fish consistently. They discover through experience where, and at what depth, they can expect to find the kind of fish they want at any season. And they realize that these productive areas change throughout the year depending on water level, temperature, food, and other factors.

With the aid of the X-3, anyone can eliminate guesswork and concentrate on the areas where fish are likely to be—even if its the first time on the lake!

The most efficient way to become acquainted with a body of water is to survey it with your X-3. Start out with a map of the lake, if possible and indicate the promising spots in relation to landmarks on shore.

As you go about your survey, your X-3 will tell you the depth and kind of bottom. It will also reveal fish, perhaps schools of crappies or white bass suspended over deep water. If multiple signals on the display indicate a good school, it is worth it to stop and fish for them. You may not get any farther.

Keep a few Lowrance Fish-N-Floats in the boat, ready to toss overboard. When the X-3 indicates a school of fish, throw the buoy out. The string will unwind until the sinker hits bottom. Then, because of the marker's flat shape, it won't unwind any farther. With the school thus marked, you can make your turn and come back to fish in exactly the right spot. This is essential when you're far from shore on a big lake. Unless you mark the school of fish when you're over it, you may not be able to find it again.

## BAIT FISH

The importance of bait fish to successful fishing can't be over-emphasized. They are the principle food of game fish in most waters.

Bait fish are the plankton feeding forage fish, such as minnows and shad. They can also be the young of game fish, such as crappies, bluegill, and white bass which also feed near the surface.

Most bait fish are concentrated within five feet of the surface where sunlight promotes the growth of the plankton on which they feed. One method of fishing is to use the X-3 to find the bait fish first. Usually, game fish will be nearby—often directly beneath the school of bait fish at 12 to 15 feet deep.

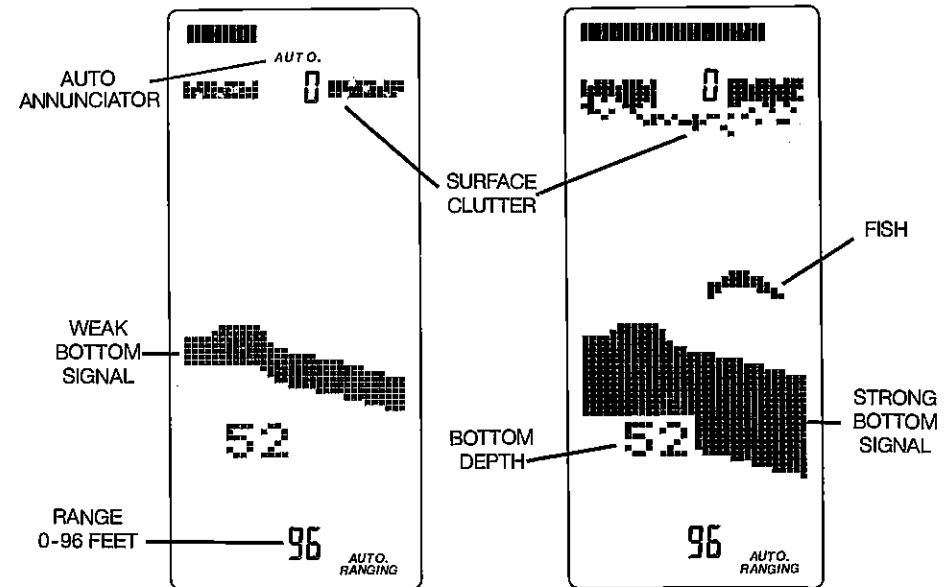

Figure 3

Figure 4

To manually adjust the sensitivity, press the AUTO key. The AUTO annunciator will disappear. To increase the sensitivity, press and hold the right arrow key > until the sensitivity is at the desired level. The left arrow key < decreases sensitivity in the same manner. Notice how the sensitivity bar moves as you change settings. When you press the right arrow key, the bar moves to the right, showing an increase in sensitivity. Pressing the left arrow key moves the bar to the left, showing a decrease in sensitivity. You can also see the changes on the display. Figure 3 shows a graph with too little sensitivity, while on the right, the sensitivity is adjusted properly. Note how the surface signal is very small, and the bottom signal is also narrow on the left chart. On the right, the sensitivity is adjusted properly; a fish is now visible, the surface clutter is more pronounced, and the bottom signal has widened. For more information on graph records, see the section called Graph Interpretation.

When the horizontal bar reaches the far right hand side of the screen, the sensitivity level is at the maximum level. When high sensitivity settings are used, a second bottom echo may appear. This is normal and is caused by the returning signal reflecting off the surface of the water, making a second trip to the bottom and back.

To turn Auto Sensitivity back on, press the AUTO key. Remember, the automatic sensitivity control can be turned off or on at any time by using the AUTO key. See Page 22 for more auto sensitivity features.



## CHART SPEED

When the X-3 is first turned on, the chart speed runs at a pre-determined speed. If a higher speed is desired, press and hold the FAST key in the chart section of the keyboard until it runs at the desired speed. To slow the display, press and hold the SLOW key. Whenever either of these keys are pressed, the sensitivity bar at the top of the display will change to a dashed line. This now represents the chart speed. If you press and hold the FAST key, for example, the bar will start moving to the right, signifying that the chart speed is increasing. There are thirty two steps of chart speed. By holding either the FAST or SLOW keys, the display can be speeded up or slowed down. When the horizontal bar reaches the far right side of the screen, the chart speed is at its maximum value. The X-3 will "chirp" signifying that the maximum chart speed has been reached.

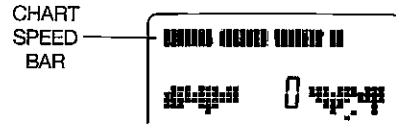
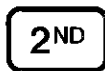

Figure 5

At times it is desirable to stop or "freeze" the display to examine an echo. Pressing the STOP/RESUME key once will freeze the display. While the display is stopped, the very top of the surface line will flash on and off to signify that the unit is in the freeze mode. Pressing STOP/RESUME again will start the display moving at the last chart speed setting.



## 2ND KEY

The X-3 has many different functions, but only a limited amount of space for keys. Therefore, some of the keys have more than one function. The key's primary function is printed very large, while the secondary function is printed underneath with small letters of a different color. The key in the middle of the bottom row labeled 2nd must be used to access the secondary functions of the keys.

For example, the 9 key has a small label beneath the number nine that says "LIGHT". If you press the 9 key by itself, the X-3 thinks that you want the number 9. However, if you press the 2nd key first, then press the nine key, the X-3 will turn on the lights in the display. The 2nd key just re-assigned the meaning of the 9 key from a 9 to LIGHT.

A knowledge of the water temperatures various fish prefer, and in which they usually remain, helps you get the most from your X-3. To find the different temperatures, a surface temperature meter, such as the LDT-3000 is a valuable aid to your fishing. This unit provides an extremely quick response to identifying the desired surface water temperatures for various species.

The temperature of water in the lake is seldom constant from top to bottom. Layers of different temperatures form, and the junction of a warm and cool layer of water is called a thermocline. The depth and thickness of the thermocline can vary with the season or time of day. In deep lakes there may be two or more at different depths. Thermoclines are important to fishermen because they are areas where fish are active. Many times bait fish will be above the thermocline while larger game fish will suspend in or just above it.

The X-3 can detect this invisible temperature layer in the water, but the sensitivity will probably have to be turned up to see it.

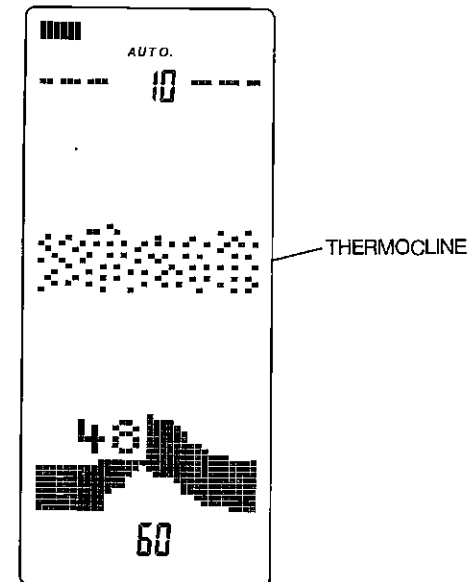

Figure 24



## SURFACE CLUTTER

The markings at the top of the screen represent the surface of the water which can extend many feet below the surface. This can interfere with fish signals or other targets. It's called Surface Clutter and is caused by algae, plankton, air bubbles caused by wave action or boat wakes, bait fish, or temperature inversions.

These marks are normal and can be seen at any time during the year. It's usually the worst in the spring and summer, slacking off in the fall and winter.

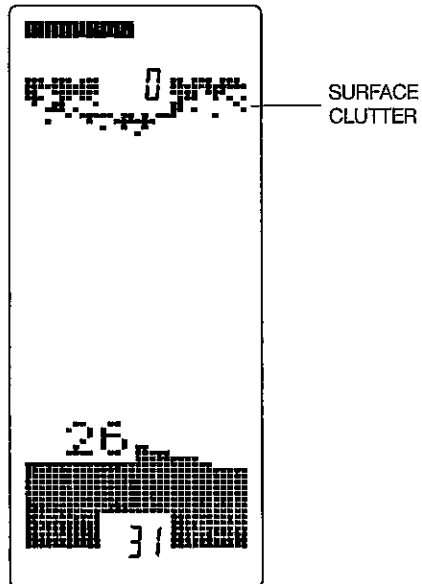

Figure 23

## WATER TEMPERATURE AND THERMOCLINES

Water temperature has an important—if not controlling—influence upon the activities of all fish. Fish are cold blooded and their bodies are near the temperature of the surrounding water. During the winter, this slows down their metabolism so that they can only utilize about a fourth as much food as they consume in the summer.

Most fish don't spawn unless the water temperature is within rather narrow limits. Trout can't survive in streams that get too warm; bass and other fish eventually die out when stocked in lakes that remain too cold during the summer. So fish will do without food rather than venture into water that is too hot or too cold; others will shift position for a temperature change as slight as one-half of one degree. While some fish have a wider temperature tolerance than others, each of them has a certain range within which it tries to stay. Schooling fish suspended over deep water lie at the level that provides this temperature in which, we assume, they are the most comfortable.



## CLEAR

If you press a key that is not what you wanted, you can wait six seconds before pressing another key and the X-3 will automatically clear or "forget" the last key entered.

For example, if you wish to turn on the lights, the proper keys to press are 2nd-9. However, if you accidentally pressed the 0 key instead of the 2nd key by accident, you could wait six seconds until the 0 disappears from the screen, then press 2nd-9. Another quick way to clear an incorrect entry is to press 2nd-0 and the last key entered will be erased.

The entire display may be erased by pressing 2nd-0-0. Everything except the digital numbers (if turned on) will be cleared from the display.

## RANGE

Although the X-3 will automatically change the range whenever the bottom gets shallower or goes deeper, there are times when it is desirable to expand the range, or look at a different segment of the water below. The range can be set anywhere from 0 to 989 feet on the upper limit and 10 to 999 feet on the lower limit, provided the lower limit is no closer to the upper limit than 10 feet.



## AUTO RANGE

When the X-3 is first turned on, the AUTO RANGE function is enabled. It may be turned off anytime by pressing the 2nd key, then the 8 key. (In this manual, pressing keys in sequence as just described will be shown like this: 2nd-8.) The AUTO RANGING annunciator in the bottom right hand corner of the display will disappear, signifying the automatic ranging capability has been turned off. To return to the AUTO RANGE mode, simply press the 2nd-8 keys again and the unit will automatically track the bottom and place it in the lower  $\frac{4}{5}$  of the screen.

## SCALE

There are ten scale markers printed on both sides of the X-3's display to help determine what the depth of a target is. For example, if the depth range is 0 to 60 feet, then each mark is equal to six feet. If the target (such as a fish) was next to the 5th line, then it is 30 feet deep (5 lines times six feet=30 feet). To make it easier to use the depth scale, use ranges in multiples of ten, i.e. 10, 30, 140, etc.

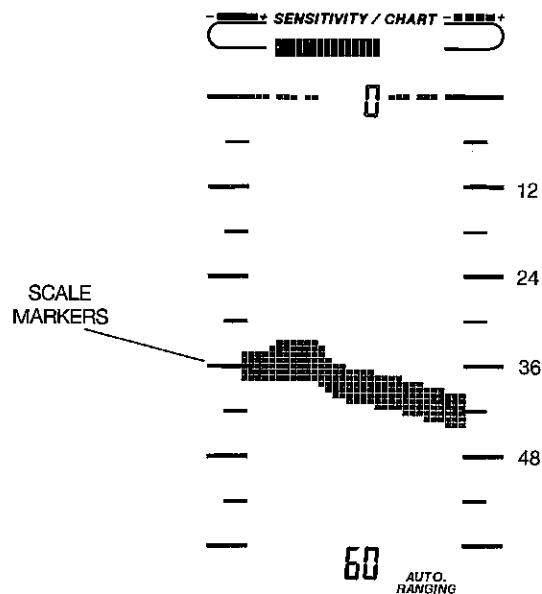

Figure 6

## LOWER LIMIT

To change the lower limit, press the lower limit desired from 10 feet to 999 feet and then press the LOWER LIMIT key. The display will immediately change to the new depth range and display the new lower limit at the bottom of the screen.

The lower limit may be changed anytime, even if the AUTO RANGE function is on. However, if a lower limit is selected that is less than the depth of the bottom while the unit is in the AUTO RANGE mode, it won't accept the entry. For example, suppose the X-3 is in the AUTO RANGE mode and the lower limit is 75 feet, with the bottom at 60 feet. If a new lower limit of 55 feet were entered on the keyboard, the X-3 would chirp, and keep the lower limit setting of 75 feet.

LOWER  
LIMIT

Remember, there must be some movement between the boat and the fish to develop the arch. Usually this means trolling at very slow speeds with the main engine in gear at a minimum throttle setting.

The depth of the water will affect the size and shape of the fish arch due to the cone angle diameter. For example, if the cone passes over a fish in shallow water, the signal displayed on the X-3 may not arch at all, due to the narrow cone diameter and the resolution limitations of the display.

Compared to a paper graph, the X-3 cannot show as fine detail because the pixels (dots on the screen) are much larger than a paper graph's. Therefore, the X-3 cannot show fish arches as well as a graph.

Very small fish probably will not arch at all, while medium sized fish will show a partial arch, or a shape similar to an arch, if they're in deep water. Large fish will arch, but the sensitivity must be turned up, especially in deeper water. There will be times when the sensitivity cannot be turned high enough to get fish arches because of the heavy surface clutter, thermoclines, etc.

One of the best ways to get fish arches is to expand or "zoom" a segment of the water, for example 40 to 60 feet. The smaller the segment, the better the screen resolution will be. Then, turn up the sensitivity as high as possible without getting too much noise on the screen. In medium to deep water, this method should work to display fish arches.

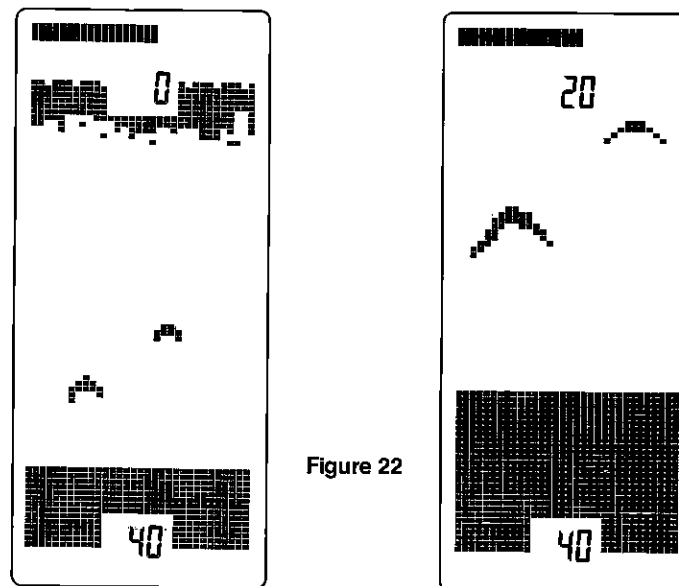

Figure 22

## FISH SIGNALS

The signals displayed on the X-3 by fish can be identified by various shaped markings in certain patterns, as opposed to random marks created by noise, or the solid, continuous markings made by the bottom.

Individual fish can, at times, be distinguished by a characteristic arch that separates them from their stationary surroundings. The reason for this is shown below. The distance to a fish when it moves into a sonar's cone of sound is shown as "A" Figure 21. When the fish has moved into the center of the cone, the distance to it will be shorter, "B" and as it moves out of the cone, the distance will increase again as shown in "C".

If a partial arch occurs most of the time on your unit (the mark curves up, but not back down, or vice-versa) it could be the transducer is not pointed straight down. If the transducer is mounted on the transom, adjust it until the fish show the distinctive arch. This may take some trial and error until the correct mounting angle is achieved.

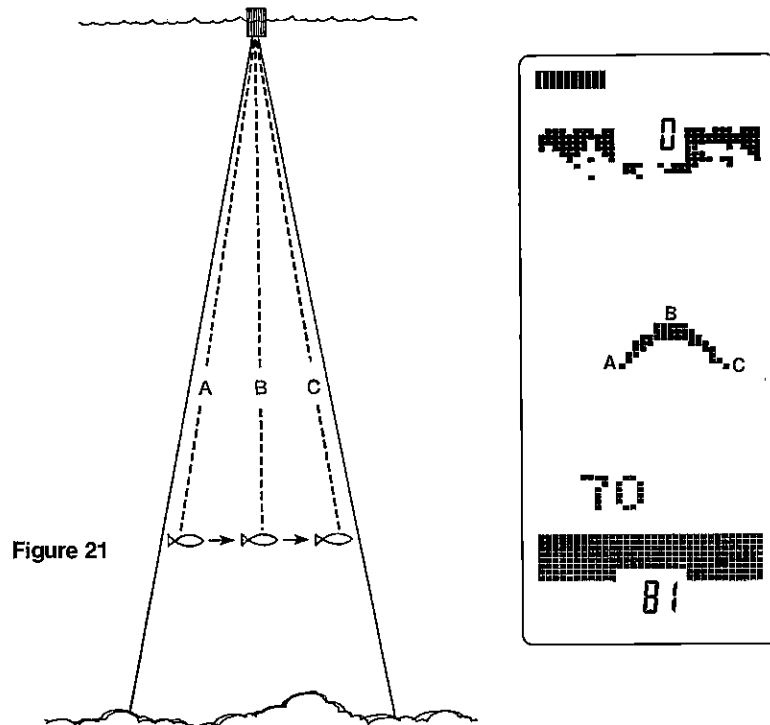

Figure 21

For example, to set the range from 0 to 31 feet, press 3-1-LOWER LIMIT.

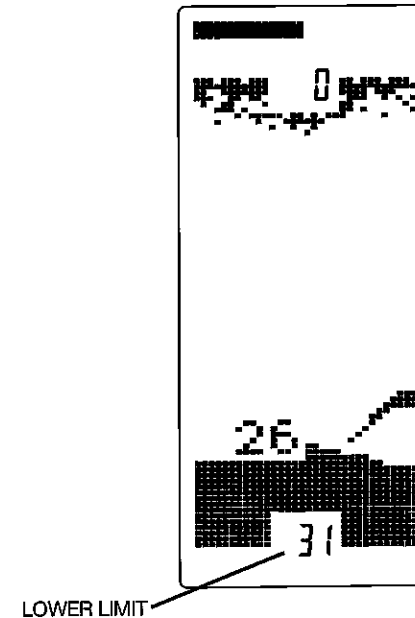

Figure 7

**NOTE:** Although the maximum lower limit of the X-3 is 999 feet, the actual depth that the X-3 will reach is dependent on the water conditions, bottom conditions, and the quality of the transducer installation.

UPPER  
LIMIT

## UPPER LIMIT

It is often desirable to expand a section of the display to show more detail. This is made possible on the X-3 by using the UPPER LIMIT key. To change the upper limit of the screen, simply press the desired depth (any number between 0 and 999 feet) and then the UPPER LIMIT key. The only restriction on the upper limit is that it must not be closer to the lower limit than 10 feet. In other words, if the lower limit is set to 81 feet, the upper limit cannot be set any closer than 71 feet. A ten foot segment or larger (20, 30, 120, etc.) is required.

Upper and lower limits may be set in various combinations to show segments from the surface to the bottom and nearly anywhere in between to expand or "zoom" a portion of the display. If a ten foot segment is chosen, then the screen resolution is 1½". This means that each dot is equal to 1½ inches when a ten foot segment is chosen.

Example: Set range to 16 to 31 feet. Press: 1-6-UPPER LIMIT then 3-1-LOWER LIMIT.

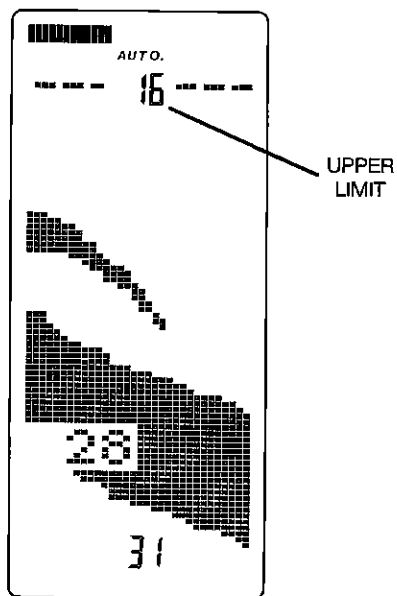

Figure 8

**NOTE:** When the X-3 is in the AUTO RANGE mode, the upper limit may be changed at any time. If the upper limit is changed while the unit is in the AUTO RANGE mode, the X-3 will continue to select a lower limit that will keep the bottom displayed in the lower  $\frac{3}{4}$  portion of the screen.



## DIGITAL

A complete digital sonar is incorporated into the X-3. It automatically discriminates between the valid bottom echoes and false echoes from fish, thermocline, or surface clutter. The digital display will show only the bottom depth. It may be used at any time, in conjunction with any other mode the X-3 may be in (with the exception of FASTRACK or High Speed Scroll modes described in the Advanced Operation section of this manual).

When the X-3 is turned on, the bottom depth will be displayed on the screen.

The 20 degree transducer is almost always the best to use in fresh water, while the 8 degree is used mostly in salt water. In a deep water environment, (300 feet—fresh water, 100 feet—salt water) the narrow cone angle is more desirable because it can penetrate to much deeper depths since the sound energy is concentrated in a smaller area.

Both the 8 degree and the 20 degree transducers give accurate bottom readings, even though the bottom signal is much wider on the 20 degree model because you are seeing more of the bottom. Remember, the shallow edge of the signal shows you the true depth. The rest of the signal tells you whether you are over rocks, mud, dropoffs, etc.

Salt water boats need to have the transducer painted with a thin coat of anti-foulant paint to prevent organisms from growing. If unchecked, barnacles and other marine growth will cause a decrease in the transducer's sensitivity. Do not use a metal based anti-foulant paint as it will decrease the transducer's sensitivity also. There are special anti-foulant paints carried by most marine dealers specifically designed for transducers.

## SIGNAL INTERPRETATION

Because your X-3 is both extremely sensitive and powerful, it can give you an accurate picture of the kind of bottom over which your boat is passing. A bottom of firm sand, gravel, shell, or hard clay returns a fairly wide signal. If the automatic sensitivity is turned off, and the signal narrows down, then it means that you have moved over a mud bottom. Mud absorbs the sound waves and returns a weak signal. Turn up the sensitivity. If you have the automatic sensitivity turned on, watch the sensitivity bar. As the boat passes over the mud bottom, the X-3 will automatically increase the sensitivity to maintain a good bottom signal. The sensitivity bar will help you in determining if the bottom is soft or hard. If it increases while in the same depth of water, then the boat has moved over a soft bottom. If it decreases, then it is over a hard bottom. Of course, as the water depth increases or decreases, the sensitivity will change, also.

Big rocks or stumps on a smooth bottom send back signals above the bottom, the distance depending upon their height. If you watch as you approach a post or a tree stump, it will be clearly visible as a short line extending above the bottom signal.

## TRANSDUCERS AND CONE ANGLE

The sound waves from the transducer go down into the water in a cone-shaped beam, much like the beam from a flashlight. The angle between the outside edges of the cone is called the cone angle.

Lowrance offers a choice of transducers with either an 8 or 20 degree cone angle that will interchange with any of the 192 kHz sonar products. In other words, any Lowrance sonar instrument can be used with any Lowrance transducer of the same frequency without retuning of any kind, and no loss of performance. However, the use of any other manufacturers' transducer will result in a loss of performance.

Generally, wide cone angle transducers (20 degrees) are ideally suited for operating in shallow to medium water depths. The 20 degree cone angle allows you to see more of the underwater world. In 15 feet of water the 20 degree cone covers an area that's about six feet across. The 8 degree transducer covers only about a two foot circle.

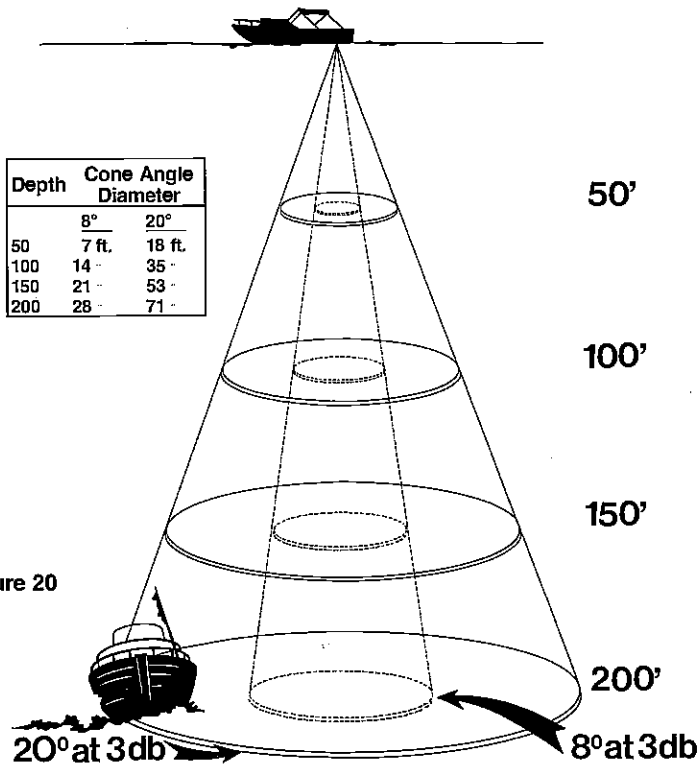

Figure 20

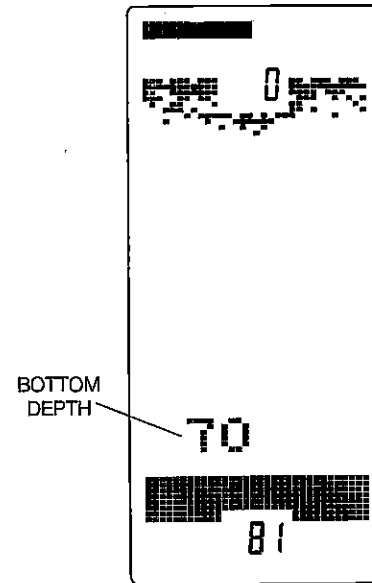

Figure 9

For easier reading, the size of the digital numbers can be doubled by pressing 2nd-2. To return them back to the smaller size, press 2nd-2 again. The numbers must be displayed on the screen before you press 2nd-2.

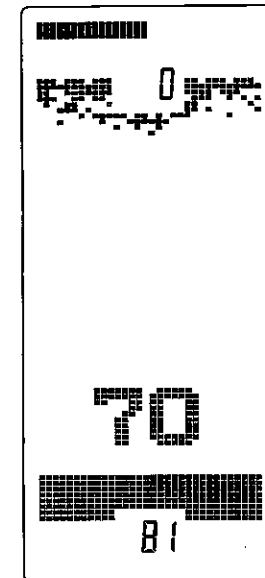

Figure 10

To turn the digital display off, or back on again, press 2nd-5.

### NOTE

Even if the digital numbers are not being displayed on the screen, the digital sonar will still continue to function. If the digital loses the bottom signal, the chart display will stop until the digital finds the bottom. If the digital numbers are being displayed on the screen, the chart display will stop, but the digital will flash the last valid bottom depth until it regains the bottom signal.

If the chart is in the freeze mode, the digital display will continue to show the bottom depth as it changes. It does not freeze when the chart does.

This gives an accurate means of determining the precise bottom depth at all times. In fact, the X-3 can be turned into a digital sonar by pressing 2nd-0-5. This will clear the screen of all echoes, including the bottom signal, and increase the size of the numbers for easier viewing.

To display the bottom and other echoes again, press the STOP/RESUME key in the chart section of the keyboard.

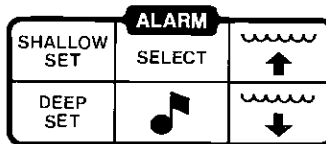

### ALARMS

The X-3 has two alarms, a chart alarm and a depth alarm. The chart alarm requires both an upper limit and a lower limit setting. The alarm then "sounds off" whenever an echo (such as a fish) is detected inside the boundaries set by the upper and lower limits.

The depth alarm also allows an upper and lower limit, but it sounds whenever the bottom echo is detected outside the boundaries set by the alarm's upper and lower limits. Both chart and depth alarms can be set, then switched back and forth. However, they cannot be used simultaneously and will be treated separately in this section.

### AUTO SENSITIVITY

Whenever the X-3 is in the auto-sensitivity mode, it will adjust the sensitivity of the unit to three steps above the minimum required to pick up the bottom signal. (There are 32 steps of sensitivity available.)

The sensitivity may be adjusted while the X-3 is in the auto-sensitivity mode. This may be desirable if the level of sensitivity that the X-3 picked is not enough to show fish or other detail. Once the sensitivity has been changed, the X-3 will increase the sensitivity enough to pick up the bottom signal, then add the level that you programmed in.

For example, if it took the X-3 five steps of sensitivity to find and lock onto the bottom, it will add three more steps for a total of eight. If desired, any amount of sensitivity up to 24 (for a total of 32) may be added. Or, three steps of sensitivity could be subtracted, however only the bottom signal would be displayed at this low sensitivity setting.

There are two ways of adjusting the sensitivity while the X-3 is in the auto-sensitivity mode.

The first is to press either the right arrow key > to increase the sensitivity or press the left arrow key < to decrease it. If the value goes below the minimum required to keep the bottom signal, the X-3 will "chirp". The same is true if you try to go above 32 steps. As you press the arrow key, the sensitivity bar will move to the left or right, according to the amount of sensitivity chosen.

The second method allows you to enter the amount of steps using the number keys on the keyboard. For example, to adjust the sensitivity so that it will always be ten steps above the minimum required to lock onto the bottom, press the 1-0-AUTO keys. The sensitivity will then increase to ten steps above the minimum required, instead of three. Remember, the total number of steps is 32.

### OTHER TIPS

If an incorrect entry is made, wait six seconds for it to disappear, then enter the desired number. Or, press 2nd-0 within six seconds of an entry and it will erase the last keystroke.

Press 2nd-FAST or SLOW to display the chart speed bar without changing the chart speed.

When changing the upper or lower limits, remember the minimum distance between the two is ten feet. If a distance smaller than ten feet is pressed, the unit will move the range to a ten foot separation. For example, if the upper limit was 0 and 9-LOWER LIMIT was entered, the X-3 would disregard the 9 and set the lower limit to ten feet.

## AUTO RANGE WITH ZOOM BOTTOM TRACK

An optional Auto Range feature is AUTO RANGE with ZOOM BOTTOM TRACK. When the X-3 is in the auto-range mode, it picks a lower limit range that will keep the bottom signal in the lower  $\frac{4}{5}$  of the screen. The upper limit is normally set to zero, unless you have changed it. However, a "window" can be used to "zoom" or expand the area near the bottom and track it as the bottom rises or falls.

For example, suppose the bottom is 85 feet deep. To display a 50 foot window around the bottom, press 5-0-2nd-8. The X-3 will choose an upper and lower limit that will place the bottom signal in a fifty foot window. The upper limit of the display may read 45 feet, while the lower limit may change to 95 feet. The bottom will be tracked and always kept inside this window as it goes deeper or shallower. This is useful if you wish to expand or "zoom" the lower section of the display without disabling the auto-range function.

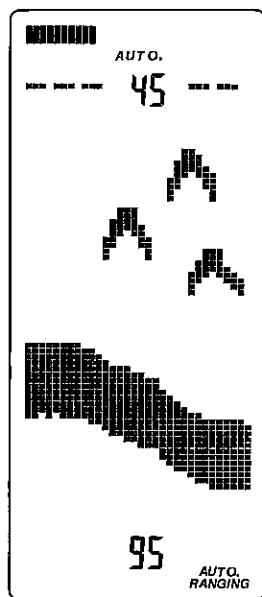

Figure 19

### NOTE

The upper and lower limits cannot be changed when the X-3 is in the Auto Range with Zoom Bottom Track mode.

To exit from the Zoom Bottom Track, press 2nd-8. This will turn off Auto Ranging, also. To return to Auto Range only, press 2nd-8 again.

## CHART ALARM

The chart alarm can be thought of as a fish alarm. It will sound whenever an echo is detected (such as a fish, or a school of fish) inside its window.

To set the chart alarm, press the SELECT key on the alarm section of the keyboard. The words CHART ALARM will be displayed in the lower left corner of the screen. To view the Chart Alarm setting, press either SHALLOW SET or DEEP SET keys. A vertical bar will be displayed on the left side of the screen. This is the alarm "window". Any echo that appears between the top and bottom of the bar will sound the alarm. Both shallow and deep ends of the bar may be adjusted to make a smaller or larger alarm "window".

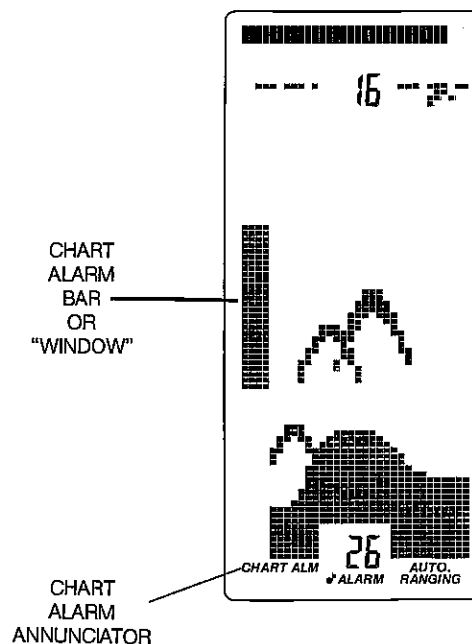





Figure 11

To adjust the top (or shallow) alarm, press the SHALLOW SET key, then press the up arrow key to move the top of the window up, or the down arrow key to move the top of the window deeper. The bottom part of the alarm window is set in the same manner. Press the DEEP SET key, then press either the up arrow key to make the bottom part of the window move shallow, or press the down arrow key to move the bottom of the window deeper. After you release the keys, the bar will remain on the screen for six seconds and then disappear. If you wish to view the chart alarm bar at any time, make certain that the CHART ALARM annunciator is visible, then press either SHALLOW SET or DEEP SET keys and the bar will be displayed for another six seconds.

If the chart alarm is set off by a fish or the bottom, the alarm will sound and the ALARM can be seen at the bottom of the display.

If the range is changed, the chart alarm may need to be changed also, since it operates independently and does not track range settings.



The note key  turns the audible tone off or on. When the alarms are first set, the audible tone is on which can be seen by the note annunciator  at the bottom of the display. To turn the audible tone off, press the note key on the keyboard once. To turn it back on, press the note key  again.

### Clearing the Chart Alarm

To turn the Chart Alarm off, press the SELECT key to switch over to the Deep Alarm, or press 2nd-0-SELECT. The annunciator "CHART ALARM" in the bottom left hand corner of the screen will go off, showing that the alarm is no longer in use. **Note:** Simply pressing the SELECT key will switch the X-3 from the chart alarm to the depth alarm. All of the chart alarm settings will remain in memory. Pressing 2nd-0-SELECT will erase the chart alarm settings.

### DEPTH ALARM

The Depth Alarm is actually two alarms. The shallow alarm gives a visual and/or audible signal when in water that is shallower than the alarm set point. The deep alarm will give a visual and/or audible signal when in water that is deeper than the alarm set point. Note that this alarm window is exactly opposite from the chart alarm. Also, the depth alarm can be set off only by the bottom signal, not by fish or any other echoes.

**NOTE:** The digital must be on in order to use the Depth Alarm.

To use the depth alarm, press the SELECT key until the DEPTH ALM annunciator appears in the lower left hand corner of the screen. When first turned on, both alarms are automatically set to zero. To set the Deep alarm, press the desired depth using the number keys on the keyboard, then press the DEEP SET key. For example, if a Deep alarm setting of 55 feet is desired, press 5-5-DEEP SET. The number 55 will show in the display in large numbers for 6 seconds and then disappear. Now if the water depth goes below 55 feet, the alarm will sound.

**NOTE:** The maximum alarm depth setting is 999 feet.



### FEET-FATHOMS-METERS

The X-3 can display the depth in either feet, fathoms, or meters. When it is first turned on, the display reads in feet. To change it to fathoms or meters, press 2nd-6. The letters "ft" will be displayed on the screen, showing that the X-3 is in the feet mode. While the letters "ft" are still displayed, press the 6 key again. Now the letters "ft" will disappear and the letters "fa" will appear. The range has changed to fathoms. Press the 6 key again and the display will show the letter "M" and change to meters. After six seconds the letters will disappear. To change the range back to feet, press 2nd-6-6. To see which range mode the unit is in, press 2nd-6 at any time and the letters ft, fa, or m will appear. When the unit is turned off, and then back on, it will always return to feet.

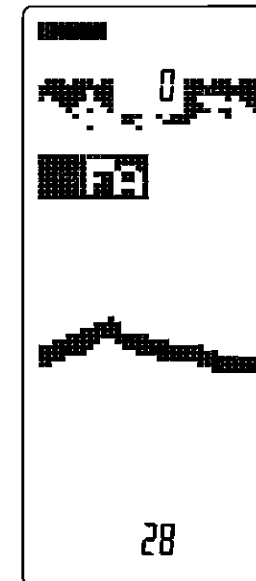

Figure 18





## FASTRAK

The FASTRAK causes the X-3 to display the bottom, fish, trees, or other echoes including the bottom signal will be converted into short, straight horizontal lines. As the bottom or other echoes moves shallow or deeper, the lines will rise or fall accordingly. This gives quick, precise depth information at a glance.

If the auto sensitivity, auto ranging, and digital functions are on, they will be disabled when the FASTRAK mode is enabled.

To start the FASTRAK mode, press 2nd-7.

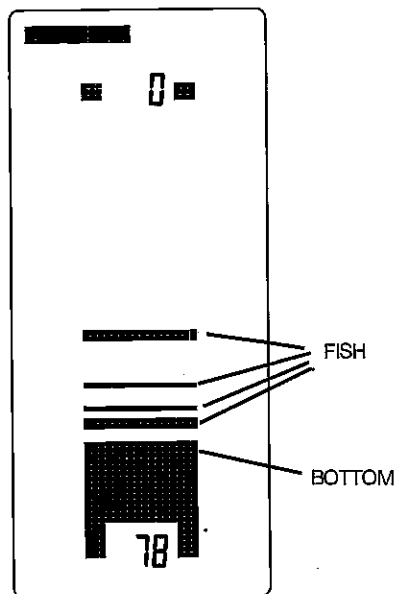

Figure 17

To exit the FASTRAK mode, press 2nd-7 again.

The auto sensitivity, auto ranging, and digital functions will still be off after the FASTRAK mode is turned off.

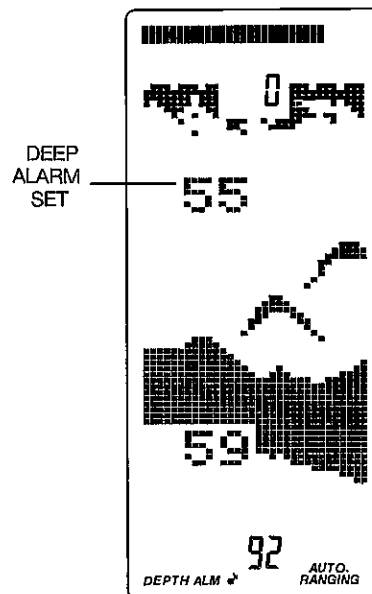

Figure 12

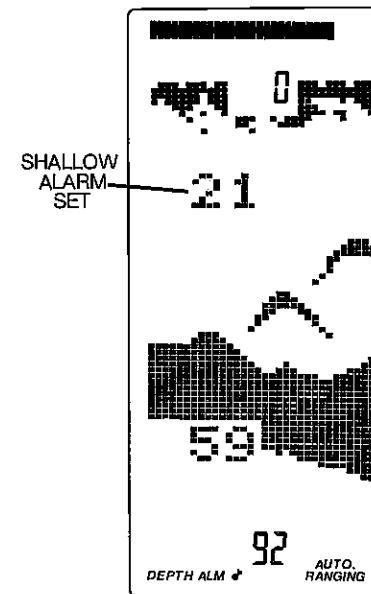





Figure 13

## Clearing the Depth Alarm

A quick method to erase or clear all functions of the depth alarm can be done by pressing 2nd-0-SELECT. This erases all alarm settings for the alarm that is currently in use. For example, to disable both the shallow and deep settings, press the SELECT key until the DEPTH ALARM annunciator is displayed in the bottom left corner of the screen, then press 2nd-0-SELECT and it will immediately be cleared. The annunciator will go off showing that the alarm is no longer in use.



The note key  turns the audible tone off or on. When the alarms are first set, the audible tone is on which can be seen by the note annunciator  at the bottom of the display. To turn the audible tone off, press the note key on the keyboard once. To turn it back on, press the note key  again.

9  
LIGHT

## LIGHT

A light is provided for operation of the X-3 at night. When the unit is first turned on, the lights will flash for 6 seconds. Press the 2nd-9 keys and the lights will stay on. To turn the lights off, press the 2nd-9 keys. The lights will also go off when the X-3 is turned off.

DISC

## DISCRIMINATION

Noise is quite often the biggest complaint fishermen have about their sonar units. Noise is any undesired signal and it can be caused either by an electrical or acoustic source, or a combination of the two. In both cases, the noise can produce unwanted marks on the display.

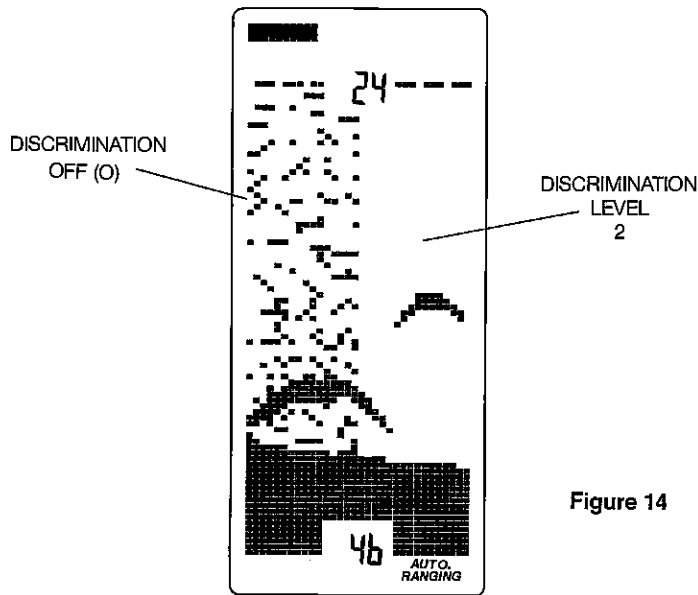

Figure 14

The Discrimination feature on the X-3 processes all incoming echoes from the receiver, determines which ones are noise and eliminates them, then displays only the legitimate echoes. Discrimination has two levels—1, and 2. 0 is “off”, 2 is the highest setting. When the X-3 is turned on, the Discrimination level is automatically set to 1. If noise is present on the display, press the level of Discrimination desired, (0, 1, and 2) then the DISC key. There should be an immediate change in the amount of noise displayed.

# ADVANCED OPERATION

4  
HI SPD

## HIGH SPEED SCROLL

If there is much noise on the screen, or when travelling at high speeds, the High Speed Scroll mode may be effective in showing targets such as fish. When this feature is turned on, all targets (including the bottom signal) will be scrolled extremely fast across the screen. Noise will still be displayed as single dots, however true target echoes such as fish will be displayed as very long lines that will stretch out across the screen. This separates the fish from the noise. Random dots are noise. Fish are long lines that may or may not arch.

To turn on HIGH SPEED SCROLL, press 2nd-4.

To turn off HIGH SPEED SCROLL, press 2nd-4 again.

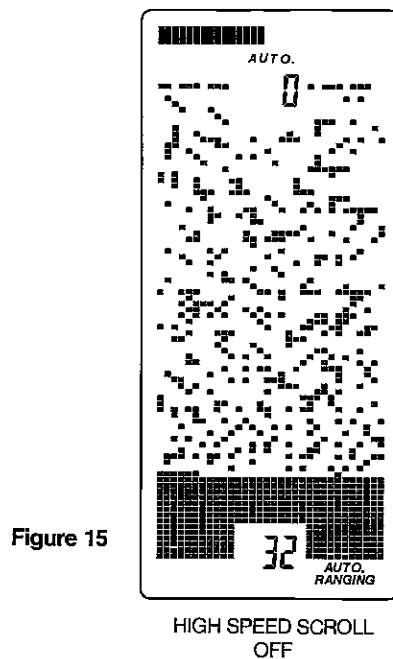

Figure 15

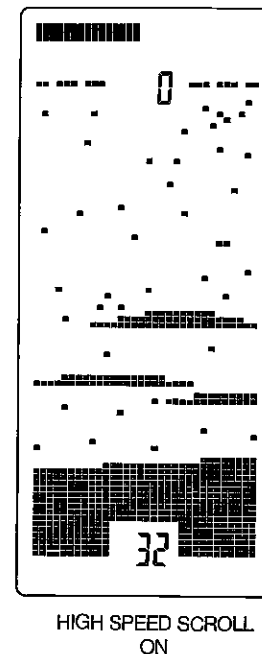

Figure 16

It is important to note when the HIGH SPEED SCROLL is enabled, auto sensitivity, auto ranging, and the digital (including the digital alarm) will be turned off. When the HIGH SPEED SCROLL is turned off, these functions will still be off.