

Part names

Unit (top/right side)

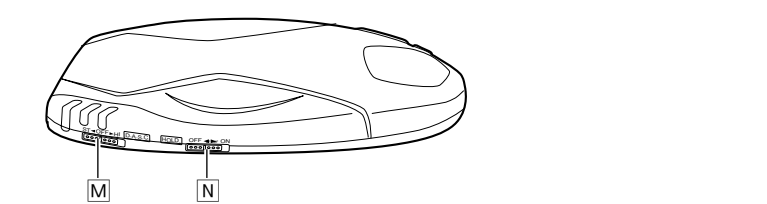
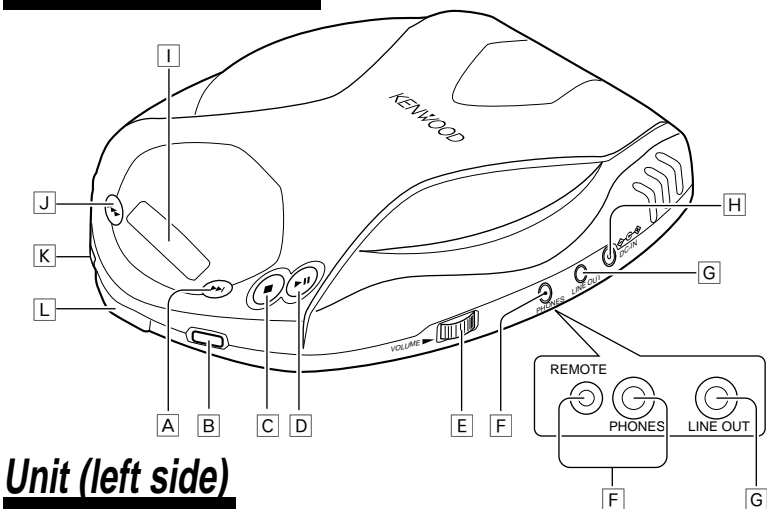

- A (Skip up/Fast forward) key
- B REPEAT (Repeat play/Shuffle play) key
- C (Stop/off) key
- D (Play/pause) key
- E VOLUME control knob
- F PHONES/REMOTE jack (for *DPC-X507)
- G PHONES jack (for DPC-X301/*DPC-X507/DPC-X602)
- H DC IN (External power) jack
- I Display
- J (Skip down/Fast reverse) key
- K P.MODE/B.B. (Program mode/Bass boost) key
- L OPEN knob (Slide to open top cover.)
- M D.A.S.C. switch (for DPC-X507/DPC-X602)
- N HOLD switch

Note:
Marked by an asterisk (*) are only for some areas.

Display (main unit)

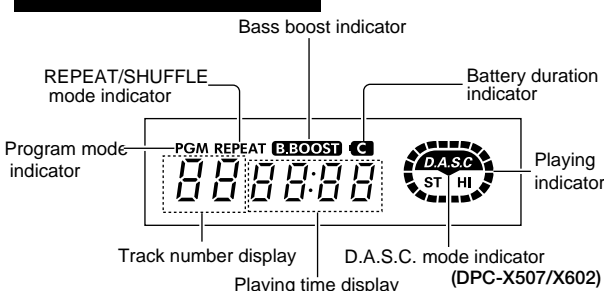

Remote control

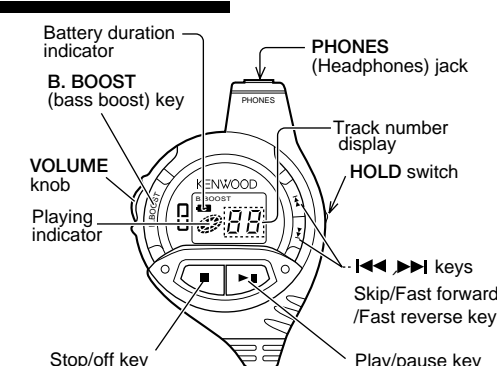

*DPC-X507 only

- Always ensure that the headphone plug is fully inserted before turning the power ON.
- If the headphone plug is inserted or removed while playback is in progress, the liquid crystal display may be inconsistent with the operation status of the unit. To correct this, turn the power OFF and then ON again.
- When the LCD remote control plug is connected, the remote control operation keys may not operate. To correct this, pull the LCD remote control's plug out of the unit, wait about 5 seconds, and then re-insert it.

Specifications

Format System Compact disc digital audio system
Laser Semiconductor laser
Audio
Frequency response 20 Hz to 20 kHz, Δ 3 dB
PHONES output level (16 Ω , 1 kHz) 10 mW + 10 mW
Line output/impedance 0.6 Vrms/1 k Ω
Power supply
External DC supply 4.5V to 6 V DC
Rechargeable batteries (NB-88 or NB-130) x 2 or 4 DC 2.4 V
Commercially-available alkaline batteries (LR6/AA) x 2 or 4 DC 3 V
Battery life (continuous repeat playback)
(Figures inside parentheses show the performance when the D.A.S.C. is ON.)
Commercially-available alkaline batteries (LR6/AA) x 2 Approx. 12 (9.5) Hours
Commercially-available alkaline batteries (LR6/AA) x 4 Approx. 25 (20) Hours
Rechargeable batteries (NB-88) x 2 Approx. 5.5 (4.5) Hours
Alkaline batteries (LR6/AA) x 2 and rechargeable batteries (NB-88) x 2 Approx. 18 (15) Hours
Dimensions (W x H x D) (DPC-X301) 132 mm x 32.5 mm x 153 mm
(5 - 3/16" x 1 - 1/4" x 6")
Dimensions (W x H x D) (DPC-X507/X602) 132 mm x 29.5 mm x 153 mm
(5 - 3/16" x 1 - 3/16" x 6")
Weight (net) (DPC-X301) 272 g (9.6 oz)
Weight (net) (DPC-X507/X602) 260 g (9.2 oz)

Note:
KENWOOD follows a policy of continuous advancements in development. For this reason specifications may be changed without notice.

Accessories	DPC-X301	DPC-X507	DPC-X602
AC adaptor	1	1	1
Headphones	1	1	1
Remote control	-	*1	-
Rechargeable batteries	*2	2	-
Car battery adaptor	-	-	1
Car cassette adaptor	-	-	1
AC plug adaptor	*1	*1	*1

Note: The accessories marked by an asterisk (*) are provided only for certain areas. The standard accessories vary depending on the model of the unit. The accessories which are not standard are optionally available. For details, please consult your dealer.

KENWOOD For your records
Record the serial number, found on the back panel of the unit, in the spaces designated on the warranty card, and in the space provided below. Refer to the model and serial numbers whenever you call upon your dealer for information or service on this product.
Model _____ Serial Number _____

KENWOOD

DPC-X301 DPC-X507 DPC-X602

PORTABLE COMPACT DISC PLAYER INSTRUCTION MANUAL

KENWOOD CORPORATION

Note:
This instruction manual is for common use with the 3 models above.

Unpacking

Unpack the unit carefully and make sure that all accessories are put aside so they will not be lost. Examine the unit for any possibility of shipping damage. If your unit is damaged or fails to operate, notify your dealer immediately. If your unit was shipped to you directly, notify the shipping company without delay. Only the consignee (the person or company receiving the unit) can file a claim against the carrier for shipping damage. We recommend that you retain the original carton and packing materials for use should you transport or ship the unit in the future. Keep this manual handy for future reference.

Before using the rechargeable batteries
The rechargeable batteries comes non-charged condition. Read "Rechargeable battery operation" carefully and charge the batteries before use.



Safety precautions

Caution: Read this page carefully to ensure safe operation.

WARNING: TO PREVENT FIRE OR ELECTRIC SHOCK, DO NOT EXPOSE THIS APPLIANCE TO RAIN OR MOISTURE.

IMPORTANT SAFEGUARDS

Please read all of the safety and operating instructions before operating this unit. For best results, follow all warnings placed on the unit and adhere to the operating and use instructions. These safety and operating instructions should be retained for future reference.

- Power sources** — The unit should be connected to a power supply only of the type described in the operating instructions or as marked on the appliance.
 - Cleaning — Do not use volatile solvents such as alcohol, paint thinner, gasoline, or benzine, etc. to clean the cabinet. Use a clean dry cloth.
- Power-cord protection** — Power-supply cords should be routed so that they are not likely to be walked on or pinched by items placed upon or against them. Pay particular attention to cords at plugs, convenience receptacles, and the point where they exit from the unit.
- Enclosure removal** — Never remove the enclosure. If the internal parts are touched accidentally, a serious electric shock might occur.
- Drop** — Do not drop the unit or apply strong shock to it. (Damage due to dropping the unit is not covered by the warranty.)
- Ventilation** — Avoid hindering the ventilation of the unit by covering it with a cloth, etc.
- Abnormal smell** — If an abnormal smell or smoke is detected, immediately turn the power OFF and pull out the power cord. Contact your dealer or nearest service center.
- Heat** — Avoid placing the unit under direct sunlight or near a source of heat such as heating equipment. Particularly, never leave it in an automobile or on the dashboard.
- Temperature** — The unit may not function properly if used at extremely low, or freezing temperatures. The ideal ambient temperature is above +5°C (41°F).
- Water and moisture** — The unit should not be used near water — for example, near a bathtub, washbowl, kitchen sink, laundry tub, in a wet basement, or near a swimming pool, etc.
- Dust and moisture** — Avoid places where is dusty or where the humidity is high.
- Vibrations** — Avoid placing the unit on an unstable place such as a shelf or in a place subject to vibrations.
- Magnetic fields** — Keep the unit away from sources of magnetic fields such as TV sets, speaker systems, radios, motorized toys or magnetized objects.
- Cleaning** — Do not use volatile solvents such as alcohol, paint thinner, gasoline, or benzine, etc. to clean the cabinet. Use a clean dry cloth.
- Nonuse periods** — The power cord of the unit should be unplugged from the outlet when left unused for a long period of time.
- Damage requiring service** — The unit should be serviced by qualified service personnel when:
 - The power-supply cord or the plug has been damaged.
 - Objects have fallen, or liquid has been spilled into the unit.
 - The unit has been exposed to rain.
 - The unit does not appear to operate normally or exhibits a marked change in performance.
 - The unit has been dropped, or the enclosure damaged.
- Servicing** — The user should not attempt to service the unit beyond that described in the operating instructions. All other servicing should be referred to qualified service personnel.
- CAUTION — TO PREVENT ELECTRIC SHOCK DO NOT USE THE AC PLUG WITH AN EXTENSION CORD, RECEPTACLE OR OTHER OUTLET UNLESS THE BLADES CAN BE FULLY INSERTED TO PREVENT BLADE EXPOSURE.**

Notes on using through car stereo

- In case of abnormality such as smoke production, immediately unplug the car battery adaptor from the cigar lighter socket.
- Do not leave the products or batteries in the car, particularly above the dashboard, for this may lead to malfunction or damage due to solar heat.
- If the unit is connected to a car stereo using an audio cord, noise may sometimes interfere.

In case of abnormality, immediately press the key to turn the power OFF, and unplug the AC adaptor from the power outlet. Then please contact your nearest KENWOOD service center.

Sound skip guard function (D.A.S.C.)

(Only for DPC-X507 and DPC-X602)

D.A.S.C. (Digital Anti Shock Circuit)

When the D.A.S.C. function is operating, about a 10 or 40-second portion of signals is always stored in memory. Consequently, when the unit receives an impact, playback will continue without interruption even if the signal from the light pickup is interrupted.

Mechanism of D.A.S.C.

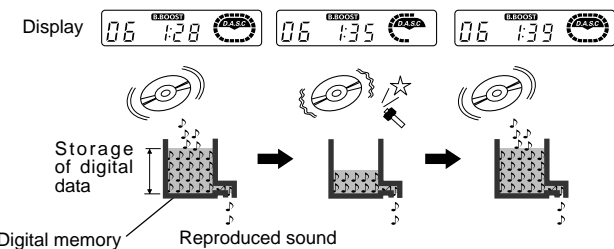

Depending on the extent of the impact, the data in the memory may be used up, so the playback skip protection may momentarily be ineffective.

Setting the D.A.S.C.



ST position: Data are held for about 10 sec.
Playback with high sound quality is possible.

HI position: Data are held for about 40 sec.

- The reproduced sound is interrupted during switching.
- When the player is used in a place free of vibration, it is recommended to release the D.A.S.C. to extend the play time by reducing the battery power.

In case of difficulty

What seems to be a serious trouble may sometimes be due to a simple mistake. Before calling for service, check the items shown in the following table again. (If you request servicing due to the reasons shown in the table, the service may be charged in some cases.)

Symptom	Cause	Remedy
No operation occurs when operation keys are pressed.	<ul style="list-style-type: none"> ● The HOLD switch of the main unit is set to ON. ● The batteries are exhausted. 	<ul style="list-style-type: none"> ● Set the switch to OFF.
No sound is heard from the headphones.	<ul style="list-style-type: none"> ● The disc is placed upside down. ● Condensation has occurred inside the unit. ● The AC adaptor or car battery adaptor is disconnected. 	<ul style="list-style-type: none"> ● Replace the two alkaline batteries, or recharge the rechargeable batteries. ● Place the disc with the labeled side up. ● Leave the unit for about 1 hour before re-use. ● Connect it properly.
Sound skips, or is interrupted.	<ul style="list-style-type: none"> ● The D.A.S.C. is set to "OFF". (only for DPC-X507 and DPC-X602) ● A strong vibration that exceeds the capacity of the D.A.S.C. has occurred. ● The disc is dirty. ● The lens is dirty. ● The headphone plug is dirty. ● The batteries are low. 	<ul style="list-style-type: none"> ● Set the D.A.S.C. to on. (only for DPC-X507 and DPC-X602) ● Place the unit in a place not subject to vibration. ● Clean it. ● Clean it. ● Clean it. ● Replace or recharge the batteries.
Noise interferes.	<ul style="list-style-type: none"> ● The headphone plug is dirty. ● The batteries are low. ● The headphones are connected incompletely. 	<ul style="list-style-type: none"> ● Clean it. ● Replace or recharge the batteries. ● Insert the plug securely into the PHONES jack.
Rechargeable batteries cannot be recharged.	<ul style="list-style-type: none"> ● Commercially available rechargeable batteries are used. 	<ul style="list-style-type: none"> ● Use the exclusive rechargeable batteries (NB-88 or NB-77).

Note: This system uses a microcomputer so it may malfunction due to external noise or interference. In such a case, unplug the power cord and remove the batteries, then re-connect the power cord and insert the batteries again.

Maintenance

Simple care

Care of lens

When the lens in the pick-up gets dirty, malfunctions including the impossibility of playback may occur. The lens should be cleaned using a commercially available camera lens blower, etc. Do not touch the lens to prevent damaging the mechanism. Also do not use a lens cleaner or disc cleaner product.

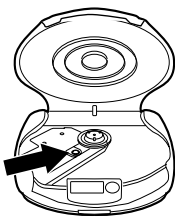

Care of main unit

When the unit gets dirty, clean with a soft, dry cloth. If the unit is stained seriously, a moistened cloth can be used. Do not use benzine or thinner for these will damage the unit.

Cleaning the plug

Wipe the headphone plug with a soft cloth to keep it clean. A dirty plug may cause noise or malfunction.

Caution on disc used

Usable discs

This unit is capable of playing discs marked with . Other discs cannot be played. 8 cm single CDs can be played as they are; do not use a commercially-available single CD adaptor.

Handling

Hold compact discs so that you do not touch the playing surface. Do not attach paper or tape to either the playing side or the label side of compact discs.

Never play a cracked or warped disc.

During playback, the disc rotates at high speed in the player. Therefore, to avoid danger, never use a cracked or deformed disc or a disc repaired with tape or adhesive agent.

Cleaning

If fingerprints or foreign matter become attached to the disc, lightly wipe the disc with a soft cotton cloth (or similar) from the center of the disc outwards in a radial manner.

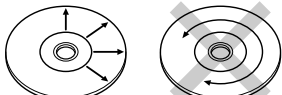

Storage

When a disc is not to be played for a long period of time, remove it from the CD player and store it in its case.

Precaution against condensation

Immediately after a room is heated or in a room with high humidity (or vapor), the unit may malfunction due to the condensation of dew or mist on the pick-up lens. In such a case, leave the unit for about an hour before trying to use it again.

For rechargeable battery

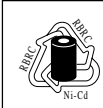

ATTENTION

Nickel-Cadmium batteries must be recycled or disposed of properly. State laws may vary regarding the handling and disposal of Nickel-Cadmium batteries. Please contact your Authorized KENWOOD Dealer for more information.

Before applying power

Caution: Read this page carefully to ensure safe operation.

AC adaptors are designed for operation as follows.

U.S.A. and Canada AC 120 V only
Europe and U.K. AC 230 V only
Australia AC 240 V only
*Other countries AC 110-120 / 220-240 V switchable

*For other countries

AC voltage selection

This unit operates on 110-120 or 220-240 AC voltage. The AC voltage selector switch on the AC adaptor is set to the voltage that prevails in the area to which the unit is shipped. Before connecting the power cord to your AC outlet, make sure that the setting position of this switch matches your line voltage. If not, it must be set to your voltage in accordance to the following direction.

Note:

Our warranty does not cover damage caused by excessive line voltage due to improper setting of the AC voltage selector switch.

AC voltage selector switch

Move switch lever to match your line voltage with a small screwdriver or other pointed tool.

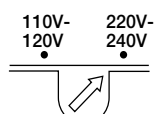

The marking of products using lasers (Except for some areas).

CLASS 1
LASER PRODUCT

This label is attached to the bottom panel and says that the component uses laser beams that have been classified as Class 1. It means that the unit is utilizing laser beams that are of a weaker class. There is no danger of hazardous radiation outside the unit.

Power sources

⚠ Caution: Read this page carefully to ensure safe operation.

This unit can be powered with three kinds of supplies including the batteries, household power line and car battery.

Using the AC adaptor

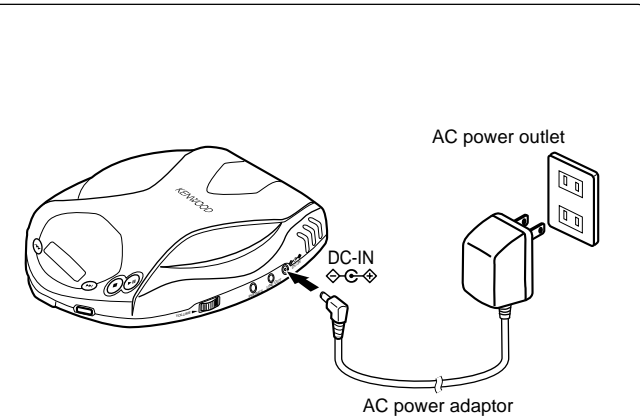

Using the car battery adaptor

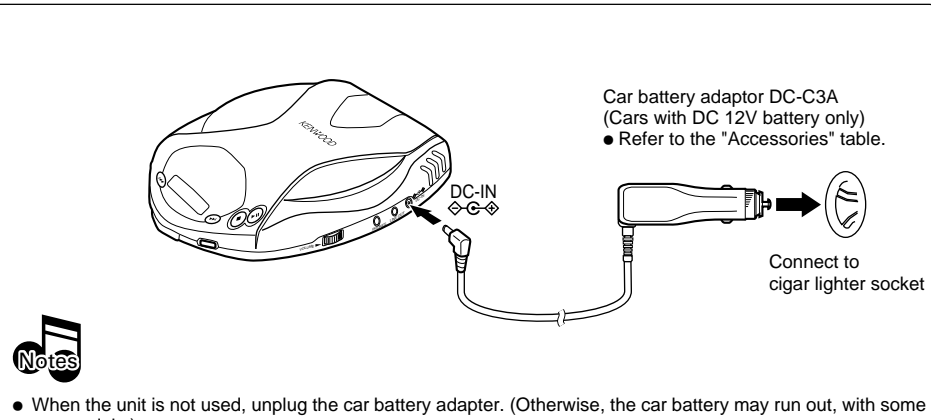

- When the unit is not used, unplug the car battery adaptor. (Otherwise, the car battery may run out, with some car models.)
- The plug may not match the cigar lighter socket of some car models.
- If the unit cannot be operated with the car battery adaptor connected, suspect the possibility of a blown fuse. The fuse can be replaced by turning the electrode on the tip of the adaptor plug. When replacing the fuse, be sure to use a fuse with a rating of 1 A.

Rechargeable battery operation

Always use the specially provided rechargeable battery (NB-88) or a separately sold rechargeable batteries NB-88 or NB-77. Never use the batteries other than the batteries authorized by Kenwood.

Loading the batteries

1 Open the battery cover.

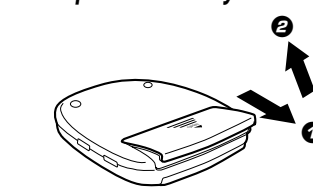

2 Insert 2 rechargeable batteries and close the cover.

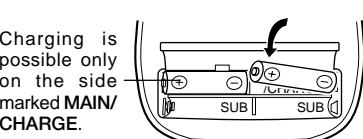

Charging is possible only on the side marked MAIN/CHARGE.

- Insert 2 rechargeable batteries into the side of the battery case where "MAIN/CHARGE" is displayed.
- Make sure the positive (+) and negative (-) poles are properly aligned.

Charging the rechargeable batteries

1 Switch the power OFF.



2 Plug in the AC adaptor.

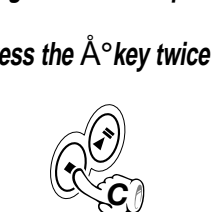

3 Press the A key twice quickly.



4 Removing the AC adaptor.

After the batteries have been charged, remove the AC adaptor.



- When using a rechargeable battery which is new or which has not been used for more than 2 months, the operating period may be shorter than normal. This is due to the properties of the battery and not a malfunction. After recharging, use the battery on the unit until it is exhausted. The original performance of the battery performance can be recovered by repeating this cycle a few times.
- Recharging is not possible during playback. Be sure to switch the power OFF before starting recharging.
- Be sure to close the top cover of the unit before proceeding to recharging.
- Recharging completes in about 6 hours. Avoid recharging batteries over 6 hours.

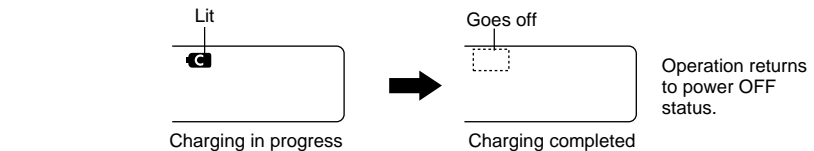

- Rechargeable batteries can be recharged for about 500 times. When the playable time per charge reduces, please newly purchase the optional (NB-88 or NB-77) rechargeable batteries.
- When charging is to be stopped, press the A key once to supply power, and then press the A key to switch off the power.

⚠ Always pay attention to the following contents when the unit is to be used with four batteries.

When operating the unit with 4 batteries

This unit can be operated with 4 alkaline batteries, or with 2 rechargeable batteries and 2 alkaline batteries. When 4 batteries are used, the unit will operate for a longer time.

- When 4 batteries are used, make sure they are arranged so that batteries of the same type are in line horizontally (see illustration).
- Do not combine batteries that have different model numbers (NB-88, NB-77).
- Exchange the same type of batteries at the same time.

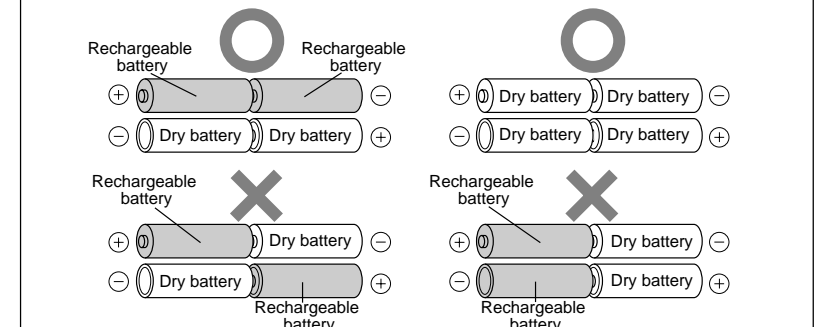

Battery duration indicator

The duration at which the battery indicator starts to blink is variable depending on the type of battery used. Refer to the table on the right.

Battery indicator	Battery Type	Blinking Timing	Treatment
	Rechargeable batteries	When the batteries is nearly exhausted.	In a while, the power will be turned off automatically. Then recharge the batteries.
	Alkaline batteries	When the batteries are half exhausted.	Playback is possible while the indicator is blinking.

Playback from the first track

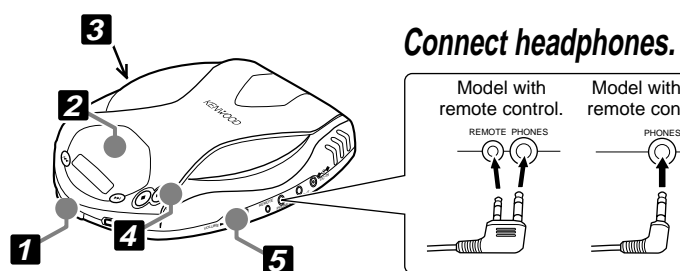

1 Open the top cover.

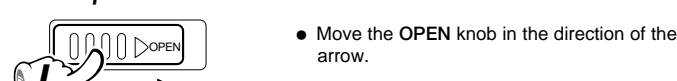

2 Insert disc and close the top cover.

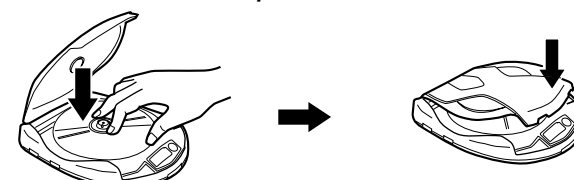

- Insert with labeled side up.
- Secure the disc by pushing a position near the center hole until it clicks.
- Close securely by pushing the front center position of the top cover until it clicks.

To pause playback temporarily

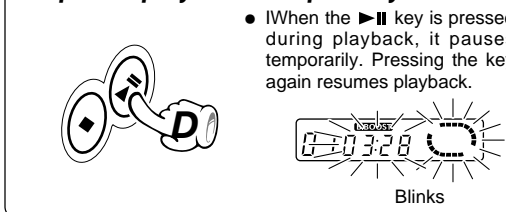

- When the PAUSE key is pressed during playback, it pauses temporarily. Pressing the key again resumes playback.

To stop playback

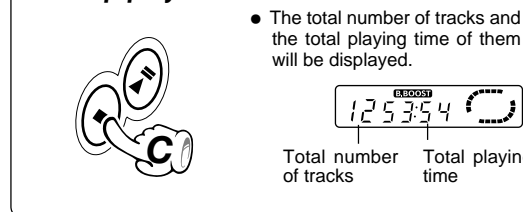

- The total number of tracks and the total playing time of them will be displayed.

Playback from desired track

Skipping tracks

press the left key or the right key.

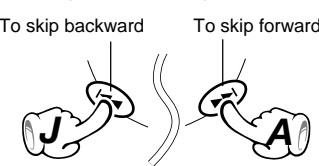

- When the right skip key is pressed, playback will skip to the start of the subsequent track.
- Each time the key is pressed, playback will skip to the next track.

- When the left skip key is pressed, playback will skip to the start of the track being played back.
- Each time the key is pressed, playback will skip to the previous track.

Fast forward, fast reverse

Hold the key pressed during playback.

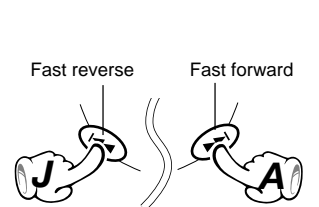

- Fast forward is engaged by pressing and holding down the right skip key while playback is in progress.
- Fast reverse is engaged by pressing and holding down the left skip key while playback is in progress.

- Playback will resume when either key is released.

Repeat playback/Shuffle playback

It is possible to listen to one track or all tracks of a CD repeatedly or to listen to the tracks in random sequence. (SHUFFLE play)

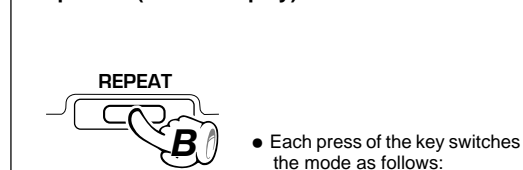

- Each press of the key switches the mode as follows:

1 One-track repeat

The track being played or the selected track will be played repeatedly.

2 All-track repeat

All tracks on the disc will be played repeatedly.

3 Shuffle play

All tracks on the disc will be played in a random order.

4 Repeat OFF

Return to normal playback is made.

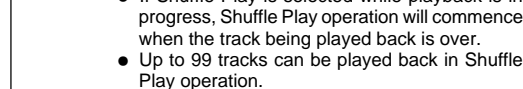

- If a key is pressed just before the end of a track and the track does not change, press the REPEAT key again when the track being played back is over.
- If Shuffle Play is selected while playback is in progress, Shuffle Play operation will commence when the track being played back is over.
- Up to 99 tracks can be played back in Shuffle Play operation.
- If Shuffle Play is selected when operation is in Stop status, Shuffle play operation will commence immediately.

Changing the tone

Compensation of low frequencies

The low frequencies sound, which is felt in headphone, can be boosted.

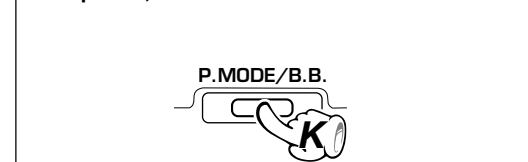

- Each press of the key switches the mode as follows:

1 Bass Boost ON

Low frequencies are boosted.

2 Bass Boost OFF

Normal tone reproduction.

The BASS BOOST is not applied to the output from the LINE OUT jack.

Hold facility

The operation keys of the main unit are deactivated. This position prevents undesired operation when the unit is put in a bag, etc.

When the HOLD switch on the unit is switched ON, the unit's keys are protected.

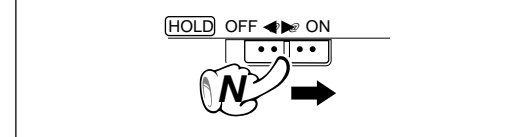

Be sure to OFF the switch before performing any operations. Operations cannot be performed if it is in the ON position.

Programming tracks in desired order

Favorite tracks (max. 24 tracks) can be programmed.

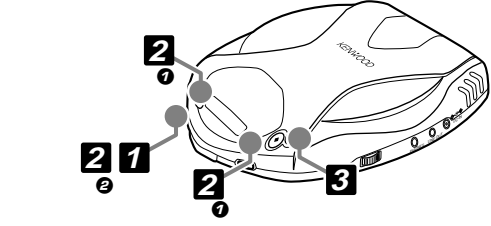

1 Press the P.MODE/B.B. key for at least 1 second during Stop status.

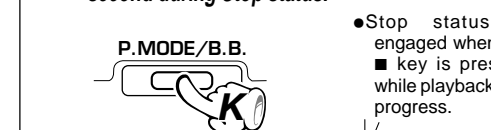

- Stop status is engaged when the A key is pressed while playback is in progress.

2 Select the desired track numbers in the order you want to play them.



- Select a track... and enter it.

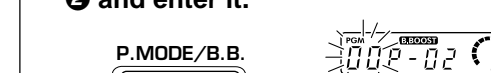

- Repeat steps 1 and 2 and enter the Track Nos. into the program in order.
- When 24 tracks have been programmed, "FULL" will be displayed.

3 Start playback.



The following program sequence will be displayed.

Connections

Ensure that the power of all components is off before connecting the cords.

Listening through car audio

- If sound is not produced, change the tape playing direction of the car stereo. (Sound is not produced if the car stereo is set to play tape side B)
- Audio reproduction may be impossible with the following type of car stereo. One-way models which have the play head on the left side. Models which function by detecting the tape tension. (With these car stereo models, the car cassette adaptor is ejected automatically when it is inserted.)

Car cassette adaptor insertion methods

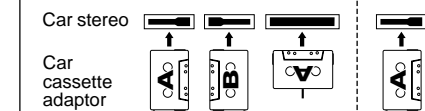

- Insert the car cassette adaptor by setting the played edge and cord position as shown in the illustration.
- "B" indicates the reverse side of the car cassette adaptor.
- For details, please read the instructions for the car cassette adaptor.

To change the programmed contents

1 Press the P.MODE/B.B. key for at least 1 second during Stop status.

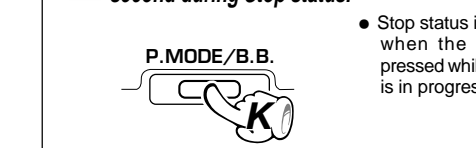

2 Call the programmed order to be changed.

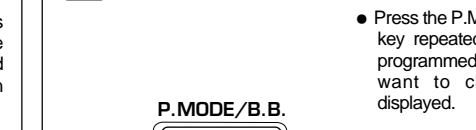

- Press the P.MODE/B.B. key repeatedly until the programmed order you want to change is displayed.

3 Enter the Track No. you want to change.

1 Select a track...



2 and enter it.

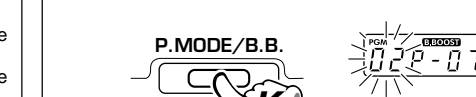

When the programmed contents are to be changed further, repeat steps 2 and 3.

To check the programmed contents

1 Press the P.MODE/B.B. key for at least 1 second during Stop status.

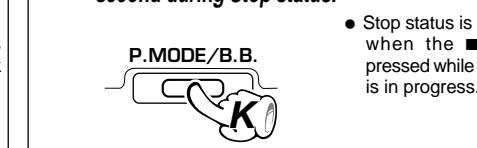

2 Press the P.MODE/B.B. key.

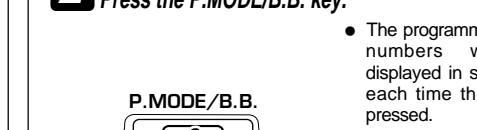

- The programmed track numbers will be displayed in sequence each time the key is pressed.

To clear the programmed contents

1 Ensure that the player is in stop mode.

2 Press the A key.

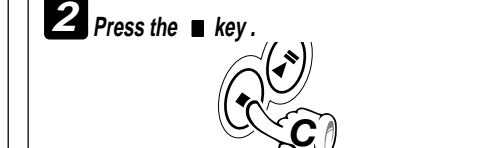

Program mode can be canceled even if the top cover is open.

