

KENWOOD

CD-RECEIVER

KDC-X790 KDC-MP732

INSTRUCTION MANUAL

Kenwood Corporation



SIRIUS
R E A D Y

HD Radio[®]
R E A D Y

Take the time to read through this instruction manual.

Familiarity with installation and operation procedures will help you obtain the best performance from your new CD-receiver.

For your records

Record the serial number, found on the back of the unit, in the spaces designated on the warranty card, and in the space provided below. Refer to the model and serial numbers whenever you call upon your Kenwood dealer for information or service on the product.

Model KDC-X790/ KDC-MP732 Serial number _____

US Residence Only

Register Online

Register your Kenwood product at
www.Kenwoodusa.com

Contents

Safety precautions **4**

Notes **5**

Warning **6**

About CDs **7**

About AAC, MP3 and WMA **8**

Notes on Multi-function Key System **9**

General features **10**

- Power
- Selecting the Source
- Volume
- Attenuator
- System Q
- Audio Control
- Adjusting the detail of Audio Control
- Audio Setup
- Speaker Setting
- Subwoofer Output
- TEL Mute
- Faceplate Angle Adjustment
- Theft Deterrent Faceplate
- Display Type Selection
- Graphic part Display Switching
- Wallpaper selecting
- Text Selection for Display
- Text Display Switching
- Font Color Select
- G-Analyzer display Switching
- Station/Disc Naming (SNPS/DNPS)

Tuner features **24**

- Tuning
- Tuning Mode
- Direct Access Tuning
- Station Preset Memory
- Auto Memory Entry
- Preset Tuning

RDS features **26**

- Radio Text Scroll
- PTY (Program Type)
- Registration of a station as a PTY
- Program Type preset

CD/Audio file/External disc control features **28**

- Playing CD & Audio file
- Playing External Disc
- Fast Forwarding and Reversing
- Track/File Search
- Disc Search/Folder Search
- Direct Track/File Search
- Direct Disc Search
- Track/File/Disc/Folder Repeat
- Scan Play
- Random Play
- Magazine Random Play
- All Random Play
- Folder Select
- Switching the Play mode
- Letter Seek
- Text/Title Scroll

SIRIUS tuner control features **34**

- Select SIRIUS Satellite Radio Mode
- Switching Seek Mode
- Select the channel
- Category and Channel Search
- Direct Access Tuning
- Selecting the Preset Band
- Channel Preset Memory
- Preset Tuning
- Channel Scan
- Text Scroll for SIRIUS tuner source

HD Radio control features **37**

- About HD Radio
- Tuning

Menu system 38

Menu System
Activating Security Code
Deactivating Security Code
Touch Sensor Tone
Manual Clock Adjustment
Date Adjustment
Date Mode
Synchronize Clock
DSI (Disabled System Indicator)
Selectable Illumination
Display Illumination Control
Dimmer
Built-in Amp Setting
G-Counter Level set
G-Analyzer Reset
G-Analyzer Calibration setup
G-Analyzer Horsepower Gauge setup
G-Analyzer Horsepower Analysis
G-Graphic Select
G-Analyzer Stop Watch
Dual Zone System Setting
Supreme Setting
B.M.S. (Bass Management System)
B.M.S. Frequency Offset
AMP Control
Traffic Information
CRSC (Clean Reception System Circuit)
Receive mode Setting
SIRIUS ID (ESN) display
Auxiliary Input Display Setting & Station/Disc Naming
Text Scroll
Built-in Auxiliary input Setting
CD Read Setting
Picture downloading
Voice Index
ACDrive firmware version display
Unique ID display
Audio Preset Memory
Audio Preset Recall
Demonstration mode Setting

Basic Operations of remote control 52

Accessories/ Installation Procedure 55

Connecting Wires to Terminals 56

Installation 57

Removing the Unit 59

Troubleshooting Guide 60

Specifications 64

The "AAC" logo is trademark of Dolby Laboratories.

Safety precautions

WARNING

To prevent injury while using this product, take the following safety precautions:

- To prevent a short circuit and possible fire, never put any metallic objects (such as coins or metal tools) inside the product.
- If you are the driver and your vehicle is moving, do not watch the product's display or use its controls for an extended period.
- Do not use this product in any way that prevents you from driving safely.
- Follow all driving laws and use common sense when using this product.

NOTE:

- Like your vehicle's speedometer, G-Analyzer is no more than a measuring function. The HP or G value measured by this unit may not be completely accurate due to its simplified method of measurement. The G-Analyzer is only for reference and should not be used to confirm the horsepower specifications of your vehicle.
- Mounting and wiring this product requires skills and experience. For safety's sake, leave the mounting and wiring work to professionals.

CAUTION

To prevent damage to the machine, take the following precautions:

- Make sure to ground the unit to a negative 12V DC power supply.
- Do not install the unit in a spot exposed to direct sunlight or excessive heat or humidity. Also avoid places with too much dust or the possibility of water splashing.
- Do not place the faceplate (and the faceplate case) in areas exposed to direct sunlight, excessive heat or humidity. Also avoid places with too much dust or the possibility of water splashing.
- To prevent deterioration, do not touch the terminals of the unit or faceplate with your fingers.
- Do not subject the faceplate to excessive shock, as it is a piece of precision equipment.
- When replacing a fuse, only use a new fuse with the prescribed rating. Using a fuse with the wrong rating may cause your unit to malfunction.

- Do not apply excessive force to the open faceplate or place objects on it. Doing so will cause damage or breakdown.
- Do not use your own screws. Use only the screws provided. If you use the wrong screws, you could damage the unit.

Attach the panel while you are on the vehicle

The panel lock arm appears when the panel is removed. Therefore, the panel must be attached while the electrical system of the car is operating.

Do Not Load 3-in. CDs in the CD slot

If you try to load a 3 in. CD with its adapter into the unit, the adapter might separate from the CD and damage the unit.

About CD players/disc changers connected to this unit

Kenwood disc changers/ CD players released in 1998 or later can be connected to this unit.

Refer to the catalog or consult your Kenwood dealer for connectable models of disc changers/ CD players.

Note that any Kenwood disc changers/ CD players released in 1997 or earlier and disc changers made by other makers cannot be connected to this unit. Connecting unsupported disc changers/CD players to this unit may result in damage.

Set the "O-N" Switch to the "N" position for the applicable Kenwood disc changers/ CD players. The functions you can use and the information that can be displayed may differ depending on the models being connected.



- You can damage both your unit and the CD changer if you connect them incorrectly.

Lens Fogging

When you turn on the car heater in cold weather, dew or condensation may form on the lens in the CD player of the unit. Called lens fogging, this condensation on the lens may not allow CDs to play. In such a situation, remove the disc and wait for the condensation to evaporate. If the unit still does not operate normally after a while, consult your Kenwood dealer.

Notes

- If you experience problems during installation, consult your Kenwood dealer.
- When you purchase optional accessories, check with your Kenwood dealer to make sure that they work with your model and in your area.
- If the unit fails to operate properly, press the Reset button to restore factory settings.
- Press the reset button if the disc auto changer fails to operate correctly. Normal operation should be restored.

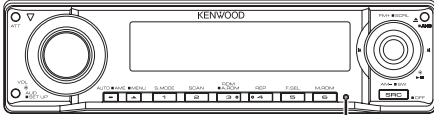

Reset button

- We recommend the use of <Activating Security Code> (page 39) to prevent theft.
- The characters conforming to ISO 8859-1 character set can be displayed.
- The RDS feature won't work where the service is not supported by any broadcasting station.
- There are places in this manual where lit indicators are described; however, the only time an indicator will light is in the following settings. When Indicator is selected as mentioned in <Text Display Switching> (page 18).
- The illustrations of the display and the panel appearing in this manual are examples used to explain more clearly how the controls are used. Therefore, what appears on the display in the illustrations may differ from what appears on the display on the actual equipment, and some of the illustrations on the display may be inapplicable.

Cleaning the Unit

If the faceplate of this unit is stained, wipe it with a dry soft cloth such as a silicon cloth.

If the faceplate is stained badly, wipe the stain off with a cloth moistened with neutral cleaner, then wipe it again with a clean soft dry cloth.



- Applying spray cleaner directly to the unit may affect its mechanical parts. Wiping the faceplate with a hard cloth or using a volatile liquid such as thinner or alcohol may scratch the surface or erase characters.

Cleaning the Faceplate Terminals

If the terminals on the unit or faceplate get dirty, wipe them with a clean soft dry cloth.

Before using this unit for the first time

This unit is initially set on the Demonstration mode. When using this unit for the first time, cancel the <Demonstration mode Setting> (page 51).

NOTE

This Class B digital apparatus complies with Canadian ICES-003.

About DAB Tuner control

Refer to [A] group on the Instruction manual of DAB Tuner KTC-9090DAB (optional accessory) for the control method of DAB Tuner function.

However, the following control methods of the function for this unit may be differed from the Instruction manual; therefore, refer to the following supplemental instruction.

<Auto Ensemble Memory Entry>

1. Select the preset band for Auto Ensemble Memory Entry.
2. Press the [AME] button for at least 2 seconds. Open Auto Ensemble Memory Entry. After storing in the memory finishes, the number of the pre-set buttons and the ensemble label are displayed.

<Searching by programme type and language> and <Languages to be displayed> in <Programme Type (PTY) Function>

At the operation to press [DISP] button, use [AUTO] button instead.

About "Media Manager" of PC application attached to KDC-X790

- "Media Manager" is recorded in the CD-ROM attached to this unit.
- Refer to the attached installation manual for the installation method of "Media Manager".
- Refer to the user's manual recorded in the installation CD-ROM and Help of "Media Manager" for the operation method of "Media Manager".
- The unit can play CD (hereafter called "ACDrive disc") created by "Media Manager".
- Refer to the following site for the updated information of "Media Manager".
<http://www.kenwood.mediamanager.jp>
- Contact Kenwood for the function and operation of the "Media Manager".
- "Media Manager" is a product of PhatNoise.

CAUTION

Use of controls or adjustments or performance of procedures other than those specified herein may result in hazardous radiation exposure. In compliance with Federal Regulations, following are reproductions of labels on, or inside the product relating to laser product safety.

Kenwood Corporation
2967-3, ISHIKAWA-MACHI,
HACHIOJI-SHI
TOKYO, JAPAN

KENWOOD CORP. CERTIFIES THIS EQUIPMENT
CONFORMS TO DHHS REGULATIONS N0.21 CFR
1040. 10, CHAPTER 1, SUBCHAPTER J.

Location : Bottom Panel

FCC WARNING

This equipment may generate or use radio frequency energy. Changes or modifications to this equipment may cause harmful interference unless the modifications are expressly approved in the instruction manual. The user could lose the authority to operate this equipment if an unauthorized change or modification is made.

NOTE

This equipment has been tested and found to comply with the limits for a Class B digital device, pursuant to Part 15 of the FCC Rules. These limits are designed to provide reasonable protection against harmful interference in a residential installation. This equipment may cause harmful interference to radio communications, if it is not installed and used in accordance with the instructions. However, there is no guarantee that interference will not occur in a particular installation. If this equipment does cause harmful interference to radio or television reception, which can be determined by turning the equipment off and on, the user is encouraged to try to correct the interference by one or more of the following measures:

- Reorient or relocate the receiving antenna.
- Increase the separation between the equipment and receiver.
- Connect the equipment into an outlet on a circuit different from that to which the receiver is connected.
- Consult the dealer or an experienced radio/TV technician for help.

About CDs

Handling CDs

- Do not touch the recording surface of the CD.



- CD-R and CD-RW are easier to damage than a normal music CD. Use a CD-R or a CD-RW after reading the caution items on the package etc.
- Do not stick tape etc. on the CD, or use a CD with tape stuck on it.

When using a new CD

If the CD center hole or outside rim has burrs, use the CD only after removing the burrs with a ballpoint pen etc.

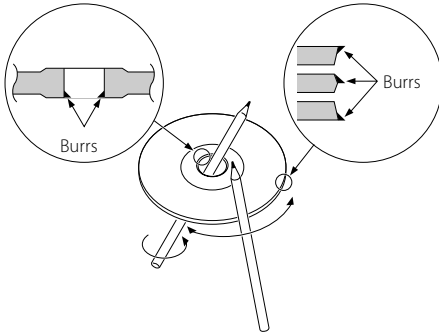

CD accessories

Do not use disc type accessories.

CD cleaning

Clean from the center of the disc and move outward.

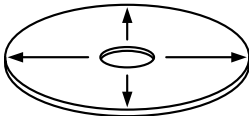

Removing CDs

When removing CDs from this unit pull them out horizontally.

CDs that cannot be used

- CDs that are not round cannot be used.

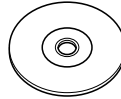

- CDs with coloring on the recording surface or CDs that are dirty cannot be used.
- This unit can only play the CDs with



This unit may not correctly play discs which do not have the mark.

- You cannot play a CD-R or CD-RW that has not been finalized. (For the finalization process refer to your CD-R/CD-RW writing software, and your CD-R/CD-RW recorder instruction manual.)

CD storage

- Do not place CDs in direct sunlight (On the seat or dashboard etc.) or where the temperature is high.
- Store CDs in their cases.

About AAC, MP3 and WMA

The playable AAC/MP3/WMA file (hereafter called Audio file) and the media format has the following limitation. The Audio file, which is not conforming to the specification, may not play normally, or the file and folder names may not display correctly.

Playable Audio file

- AAC, MP3, WMA



- Attach the correct extension for the Audio file (AAC: ".M4A", MP3: ".MP3", WMA: ".WMA")
- Do not attach the extensions to files other than the Audio file. If the extension is attached, the file, which is not the Audio file, will play and outputs a loud noise, causing damage to the speaker.
- The files with copy protection cannot be played.
- The settings of your encoding software and the environment in which it is used may now allow you to play or view specific audio files. For encoding specifications and instructions on how to set encoding software, browse through software help or check with the developers.
- The unit may not be compatible with upgrade of compression format standard and additional specifications.

Playable AAC file

- ".m4a" file encoded by AAC-LC format.
Refer to <http://www.kenwood.mediamanager.jp> for the details.

Playable MP3 file

- MPEG 1/2 Audio Layer 3 file
- Transfer bit rate: 8-320 kbps
- Sampling frequency
KDC-X790: 16, 22.05, 24, 32, 44.1, 48 kHz
KDC-MP732: 8, 11.025, 12, 16, 22.05, 24, 32, 44.1, 48 kHz

Playable WMA file

- The file in accordance with Windows Media Audio (Except for the file for Windows Media Player 9 or after which applies the new functions)
- Transfer bit rate: 48-192 kbps
- Sampling frequency: 32, 44.1, 48 kHz

Playable media

- CD-ROM, CD-R, CD-RW



- CD-RW discs which are quick formatted by the writing software cannot be used.
- When recording to the maximum media capacity at once, the writing software is set to "Disc at once".

Playable disc format

- ISO 9660 Level 1/2
- Joliet
- Romeo
- Long file name.

The maximum number of characters for display

File/Folder name:

- KDC-X790: 128 characters
- KDC-MP732: 64 characters

MP3 ID3 Tag/ WMA Contents property:
30 characters

AAC song information:

- KDC-X790: 60 characters
- KDC-MP732: 30 characters



- File/Folder name is the number of the characters including the extensions.
- This unit can display the following versions of MP3 ID3 tag:
KDC-X790: version 1.0/ 1.1/ 2.3
KDC-MP732: version 1.0/ 1.1
- AAC ID3 Tag cannot be displayed.

Limitation of structure for the file and the folder

- Maximum number of directory levels: 8
- Maximum number of folders: 100
- Maximum number of files per folder:
KDC-X790: 4096/ KDC-MP732: 255

Playing order of the Audio file

The Audio file plays in the order which is written by writing software. You may be able to set the playing order by writing the play sequence numbers such as "01" to "99" at the beginning of the file name.

Example

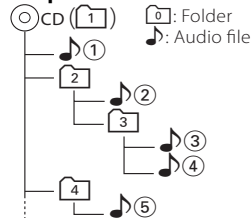

• Playing order

Playing order after ① play.

⇒ ②, ③, ④, ⑤...

• File search

Forward file search during ③ play.

Push the Control knob towards ⇒ ④

• Folder search

Forward folder search during ② play.

Push the Control knob towards [FM] ⇒ ③, ④...

• Folder select

When the selection is set to directory ①, and you want to skip to the folder ② at the same level.

Push the Control knob towards ⇒ ②

When the selection is set to directory ③, moves the level up by folder select.

Push the Control knob towards [AM] ⇒ ②

Notes on Multi-function Key System

Multi-function Key System serves to control various functions with the [1] — [6] buttons. The basic operation of the Multi-function Key System is described below.

What is the Multi-function Key System?

This unit is equipped with the Multi-function Key System that enables the operation of multiple functions with one button.

For example, you can enter the Display Control Mode or turn ON/OFF the Random Play by pressing the [3] button during CD play.

Setting each function

The function display will show the controllable function of the [1] — [6] button above the button. Pressing the [1] — [6] button below the desired function enables the setting of the function.

Displaying the desired function

If five or more functions are available to be set with the [1] — [6] button, they are divided into multiple function groups (referred to by sections in this manual) for registration. Press the [NEXT] button to switch the sections.

Example: KDC-X790

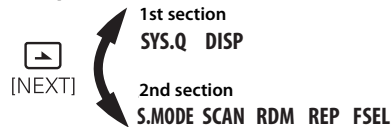

Real operational example of the Multi-function Key System

Example: Turning ON/OFF the Random Play during CD play.

1. Show the function display of the Random Play. If "RDM" is not shown in the display, press the [NEXT] button to alternate the sections until the "RDM" function display is shown above the [3] button.
2. Turn ON/OFF the Random Play. Press the [3] button. Each time you press the [3] button under the "RDM" function display the Random Play is turned ON/OFF.

Example: KDC-X790

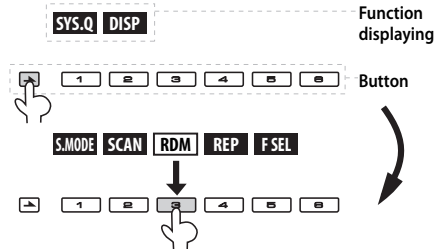

General features

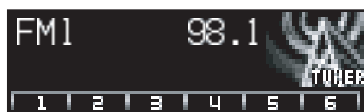
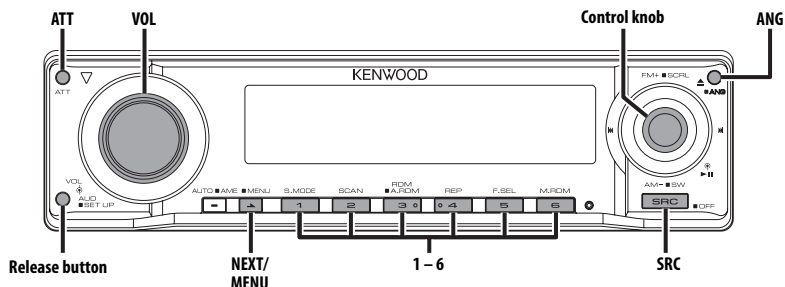

Power

Turning ON the Power

Press the [SRC] button.

Turning OFF the Power

Press the [SRC] button for at least 1 second.

Selecting the Source

Press the [SRC] button.

Source required	Display
SIRIUS tuner (Optional accessory)	"SIRIUS"
Tuner or HD Radio (Optional accessory)	"TUNER" or "HD Radio"
CD	"Compact Disc"
External disc (Optional accessory)	"CD Changer"
Auxiliary input	"AUX"
Auxiliary input (Optional accessory)	"AUX EXT"
Standby (Illumination only mode)	"STANDBY"

Volume

Increasing Volume

Turn the [VOL] knob clockwise.

Decreasing Volume

Turn the [VOL] knob counterclockwise.

Attenuator

Turning the volume down quickly.

Press the [ATT] button.

Each time you press the button, the Attenuator turns ON and OFF.

When the Attenuator is ON, "ATT" is displayed.

System Q

Selecting the best sound setting preset for different types of music.

1 Select the source to adjust

Press the [SRC] button.

2 Select the key function section

Press the [NEXT] button.

Repeatedly press the button until "SYS.Q" is displayed above the [1] button.

Refer to <Notes on Multi-function Key System> (page 9).

3 Enter System Q mode

Press the [1] ("SYS.Q") button.

4 Select the Sound type

Push the Control knob towards [◀◀] or [▶▶].

Each time the knob is pushed, the setting switches as shown below.

Sound setting	Display
User memory	"USER"
Rock	"ROCK"
Pops	"POPS"
Easy	"EASY"
Top 40	"TOP 40"
Jazz	"JAZZ"
Natural	"NATURAL"



- User memory:
The values set on the <Audio Control> (page 11).
- Change each setting value with the <Speaker Setting> (page 13).
First, select the speaker type with the Speaker setting.

Audio Control

1 Select the source to adjust

Press the [SRC] button.

2 Enter Audio Control mode

Press the [VOL] knob.

3 Select the Basic Audio item to adjust

Press the [VOL] knob.

Each time you press the knob, the item to be adjusted alternates between the items shown in the table below.

4 Adjust the Basic Audio item

Turn the [VOL] knob.

Adjustment Item	Display	Range
Rear Volume *1	"Rear Volume"	0 — 35
Subwoofer level*2,3	"Sub-W Level"	-15 — +15
Bass level*4	"Bass Level"	-8 — +8
Middle level*4	"Middle Level"	-8 — +8
Treble level*4	"Treble Level"	-8 — +8
Balance	"Balance"	Left 15 — Right 15
Fader*3	"Fader"	Rear 15 — Front 15

Exit Audio Control mode (Volume control mode)



- *1 You can control this item when "2 ZONE" of <Audio Setup> (page 12) is set to "ON".
- *2 You can control this item when <Subwoofer Output> (page 13) is set to "SW ON".
- *3 You can control this item when "2 ZONE" of <Audio Setup> (page 12) is set to "OFF".
- *4 You can adjust these items in detail. Refer to <Adjusting the detail of Audio Control>(Page 12). (Function of the KDC-X790)
- *4 Source tone memory: Puts the set up value in the memory per source. (Detail Audio item is included)

5 Exit Audio Control mode

Press any button.

Press a button other than the [VOL] knob, [ANG] and [ATT] button.

General features

Function of the KDC-X790

Adjusting the detail of Audio Control

Among the Basic Audio items, you can adjust the Bass level, Middle level, and Treble level in detail.

1 Select the Basic Audio item

Select the desired item to be set in detail from followings;

- Bass level
- Middle level
- Treble level

For how to select Basic Audio items, see <Audio Control> (page 11).

2 Enter Detail adjustment mode of Audio Control

Press the [VOL] knob for at least 1 second.

3 Select the Detail Audio item to adjust

Press the [VOL] knob.

Each time you press the knob, the item to be adjusted alternates between the items shown in the table below.

4 Adjust the Detail Audio item

Turn the [VOL] knob.

Bass level

Adjustment Item	Display	Range
Bass Center Frequency	"Bass FRQ"	40/50/60/70/80/100/120/150 Hz
Bass Q Factor	"Bass Q Factor"	1.00/1.25/1.50/2.00
Bass Extend	"Bass EXT"	OFF/ON

Middle level

Adjustment Item	Display	Range
Middle Center Frequency	"Middle FRQ"	0.5/1.0/1.5/2.0 kHz
Middle Q Factor	"Middle Q Factor"	1.00/2.00

Treble level

Adjustment Item	Display	Range
Treble Center Frequency	"Treble FRQ"	10.0/12.5/15.0/17.5 kHz

5 Exit the Detail Audio Control mode

Press the [VOL] knob for at least 1 second.



- When you set the Bass Extend to ON, low frequency response is extended by 20%.

- You can exit the Audio Control mode at anytime by pressing any button except for [VOL], [ANG] and [ATT] buttons.

Audio Setup

Setting the Sound system, such as Cross over Network.

1 Select the source to adjust

Press the [SRC] button.

2 Enter Audio Setup mode

Press the [VOL] knob for at least 1 second.

3 Select the Audio Setup item to adjust

Press the [VOL] knob.

Each time you press the knob, the item to be adjusted alternates between the items shown in the table below.

4 Setup the Audio item

Turn the [VOL] knob.

Adjustment Item	Display	Range
Front High Pass Filter* ²	"HPF-F Fc"	Through/40/60/80/100/120/150/180/220 Hz
Rear High Pass Filter* ²	"HPF-R Fc"	Through/40/60/80/100/120/150/180/220 Hz
Low Pass Filter* ^{1,2}	"LPF-SW"	50/60/80/100/120/Through Hz
Subwoofer Phase* ^{1,2,3}	"SW Phase"	Reverse (180°)/ Normal (0°)
Volume offset	"Vol-Offset"	-8 — ±0
Loudness	"LOUD"	OFF/ON
Dual Zone System	"2 ZONE"	OFF/ON



- Volume offset: Sets each source's volume as a difference from the basic volume.
- Loudness: Compensates for low and high tones during low volume.
- *¹ You can control this item when <Subwoofer Output> (page 13) is set to "SW ON".
- *² You can control this item when "2 ZONE" of <Audio Setup> (page 12) is set to "OFF".
- *³ You can control this item when Low Pass Filter is not set to Through.

- Dual Zone System
Main source and sub source (Auxiliary input) output Front channel and Rear channel separately.
 - Set up the channel of sub source by <Dual Zone System Setting> (page 45).
 - Select Main source by [SRC] button.
 - Adjust the volume of Front channel by [VOL] knob.
 - Adjust the volume of Rear channel by <Audio Control> (page 11).
 - The Audio Control has no effect on sub source.
- You can use the Dual Zone System with the Auxiliary input sources listed below.
 - Internal auxiliary input

5 Exit Audio Setup mode

Press the [VOL] knob for at least 1 second.

Speaker Setting

Fine-tuning so that the System Q value is optimal when setting the speaker type.

1 Enter Standby

Press the [SRC] button.

Select the "STANDBY" display.

2 Enter Speaker Setting mode

Press the [VOL] knob.

"SP SEL" is displayed.

3 Select the Speaker type

Turn the [VOL] knob.

Each time you turn the knob, the setting alternates between the settings shown in the table below.

Speaker type	Display
OFF	"OFF"
For 5 & 4 in. speaker	"5/4 inch"
For 6 & 6x9 in. speaker	"6x9/6 inch"
For the OEM speaker	"O.E.M."

4 Exit Speaker Setting mode

Press the [VOL] knob.

Subwoofer Output

Turning the Subwoofer output ON or OFF.

Push the Control knob toward [AM] for at least 2 seconds.

Each time you push the knob, Subwoofer output switches ON and OFF.

When it is ON, "SW ON" is displayed.



- You can control this function when "2 ZONE" of <Audio Setup> (page 12) is set to "OFF".

TEL Mute

The audio system automatically mutes when a call comes in.

When a call comes in

"CALL" is displayed.

The audio system pauses.

Listening to the audio during a call

Press the [SRC] button.

The "CALL" display disappears and the audio system comes back ON.

When the call ends

Hang up the phone.

The "CALL" display disappears and the audio system comes back ON.



- To use the TEL Mute feature, you need to hook up the MUTE wire to your telephone using a commercial telephone accessory. Refer to <Connecting Wires to Terminals> (page 56).

Faceplate Angle Adjustment

Press the [ANG] button for at least 1 second.



- Do not apply excessive force to the faceplate. It can cause damage.

General features

Theft Deterrent Faceplate

The faceplate of the unit can be detached and taken with you, helping to deter theft.

Removing the Faceplate

Press the Release button.

The faceplate is unlocked, allowing you to detach it.

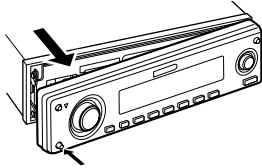

- The faceplate is a precision piece of equipment and can be damaged by shocks or jolts.
- Keep the faceplate in its faceplate case while detached.
- Do not expose the faceplate (and the faceplate case) to direct sunlight or excessive heat or humidity. Also avoid places with too much dust or the possibility of water splashing.

Reattaching the Faceplate

1 Align the shaft on the unit with the depression on the faceplate.

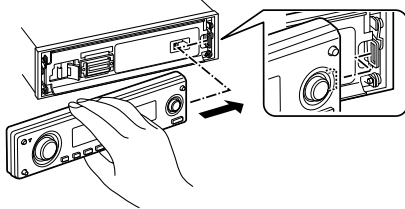

2 Push the faceplate in until it clicks.

The faceplate is locked in place, allowing you to use the unit.

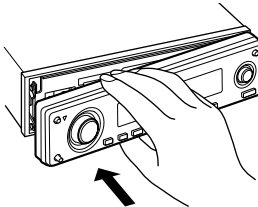

Display Type Selection

Changing the display mode.

1 Select the key function section

Press the [NEXT] button.

Repeatedly press the button until "DISP" is displayed above the [2] button.

Refer to <Notes on Multi-function Key System> (page 9).

2 Enter display control mode

Press the [2] ("DISP") button.

3 Select the display mode

Press the [1] ("MODE") button.

4 Select the display Type

Push the Control knob towards [◀◀] or [▶▶].

Each time you push the knob, the display mode alternates between the display modes shown in the table below.

Display Mode	Display
"Display Type A"	①
"Display Type B"	① ②
"Display Type C"	③ ④ ③ ⑤ ③ ⑥
"Display Type D"	④ ⑦ ⑥
"Display Type E"	⑨

- ① Graphic display part
- ② Text display part
- ③ Text icon display part
- ④ Upper text display part
- ⑤ Middle text display part
- ⑥ Lower text display part

- ⑦ Source icon display part
- ⑧ Function item display
- ⑨ G-Analyzer display part

5 Exit display control mode Press the [6] ("RTN") button.



- Under the display type other than "Display Type D", the function item is not displayed. When you select the display type other than "Display Type D", press [1] to [6] buttons or [NEXT] button. The function item will be displayed approximately 5 seconds.
- The indicator is displayed when the display type is set to "Display Type C" or "Display Type D".
- Change the information by the Display Type. Refer to the page on the following table for the methods to alternate by the Display Type.

Display Type	A	B	C	D	E
Graphic ①	15	15	—	—	—
Text ②	—	16	—	—	—
Upper ④	—	—	18	18	—
Middle ⑤	—	—	20	—	—
Lower ⑥	—	—	20	20	—
G-Analyzer ⑨	—	—	—	—	22

Display Type A/ Display Type B

Graphic part Display Switching

Changing the graphic Display.

1 Select the key function section

Press the [NEXT] button.

Repeatedly press the button until "DISP" is displayed above the [2] button. Refer to <Notes on Multi-function Key System> (page 9).

2 Enter display control mode

Press the [2] ("DISP") button.

3 Select the display mode

Press the [1] ("MODE") button.

4 Select the display Type

Push the Control knob towards [◀◀] or [▶▶].

Select the "Display Type A"/ "Display Type B" display.

5 Select the graphic display

Press the [3] ("Graph") button.

6 Select the graphic part display

Push the Control knob towards [◀◀] or [▶▶].

Each time you push the knob, the graphic display alternates between the displays shown in the table below.

Graphic display

Movie 1

Movie 2

Movie 3 (KDC-X790 only)

*Downloaded movie

Wallpaper & *Downloaded Wallpaper



- * Function of the KDC-X790
- * For Download movie and Download Wall Paper, refer to <Picture downloading> (page 49).

7 Exit display control mode

Press the [6] ("RTN") button.



- The setting of this function is available while "Display Type A"/ "Display Type B" is selected for the Display mode.

General features

Display Type A/ Display Type B

Wallpaper selecting

Selecting a wallpaper to display when Display Type is set to "Display Type A"/ "Display Type B".

1 Select the wallpaper display

Refer to <Graphic part Display Switching> (page 15).

2 Select the wallpaper

Display the wallpapers one after another

Press the Control knob.

Each time you press the knob, the Wallpaper scan is turned ON and OFF.

When scan is ON, "SCAN" is displayed.

When scan is ON, each wallpaper is displayed every several seconds.

Select wallpaper manually

1 Turn the wallpaper scan OFF.

Press the Control knob.

Each time you press the knob, the Wallpaper scan is turned ON and OFF.

2 Select the wallpaper.

Push the Control knob towards [FM] or [AM].

Each time you push the knob, the Wallpaper changes.

3 Exit Display Control mode

Press the [6] ("RTN") button.

Display Type B

Text Selection for Display

Selecting the text display.

1 Select the key function section

Press the [NEXT] button.

Repeatedly press the button until "DISP" is displayed above the [2] button.

Refer to <Notes on Multi-function Key System> (page 9).

2 Enter display control mode

Press the [2] ("DISP") button.

3 Select the display mode

Press the [1] ("MODE") button.

4 Select the display Type

Push the Control knob towards [◀◀] or [▶▶].

Select the "Display Type B" display.

5 Enter text select mode

Press the [2] ("TEXT") button.

6 Select the text

Push the Control knob towards [◀◀] or [▶▶].

In Tuner source

Information	Display
Station name or *1Program Service name	"SNPS"*
*1Radio text or *1Program Service name (FM)	"Radio Text"*
Frequency	"Frequency"
Clock	"Clock"
Date	"Date"

In CD & External disc source

Information	Display
Disc title	"Disc Title"*
Track title	"Track Title"*
Track number & Play time	"P-Time"
Disc name	"DNPS"
Clock	"Clock"
Date	"Date"

In Audio file source

Information	Display
Song title & Artist name	"Title/Artist"*
Album name & Artist name	"Album/Artist"*
Folder name	"Folder Name"
File name	"File Name"
Play time & File number	"P-Time"
Clock	"Clock"
Date	"Date"

In HD Radio source

Information	Display
Station name	"Station Name"*
Title	"Title"*
Frequency	"Frequency"
Clock	"Clock"
Date	"Date"

In Standby/ Auxiliary input source

Information	Display
Source name	"Source Name"
Clock	"Clock"
Date	"Date"

In SIRIUS tuner source

Information	Display
Channel Name	"Channel Name"
Song Title	"Song Title"
Artist Name	"Artist Name"
Composer name	"Composer Name"
Category Name	"Category Name"
Label Name	"Label Name"
Comment	"Comment"
Band & Channel Number	"Channel Number"
Clock	"Clock"
Date	"Date"

7 Exit Display Control mode

Press the [6] ("RTN") button.



- *1 KDC-X790 only.
- * If the contents of the information cannot be displayed, Play time or Frequency is displayed.
- If the contents of the information for the SIRIUS tuner source cannot be displayed, channel number is displayed.
- When LX-AMP is connected, the item setup by the Display mode of LX-AMP is displayed. (KDC-X790 only)

- Track number at Audio file displays the last 3 digits when the track number exceeds 1000 songs. (KDC-X790 only)
- Album name cannot be displayed in WMA file. (KDC-MP732 only)

General features

Display Type C/ Display Type D

Text Display Switching

Changing the text display.

1 Select the key function section

Press the [NEXT] button.

Repeatedly press the button until "DISP" is displayed above the [2] button.
Refer to <Notes on Multi-function Key System> (page 9).

2 Enter display control mode

Press the [2] ("DISP") button.

3 Select the display mode

Press the [1] ("MODE") button.

4 Select the display Type

Push the Control knob towards [◀◀] or [▶▶].

Select the "Display Type C"/"Display Type D" display.

5 Enter text select mode

Press the [2] ("TEXT") button.

6 Select the text display part

Push the Control knob towards [FM] or [AM].

The cursor (➡) moves to the selected text display part.

Select the text

Push the Control knob towards [◀◀] or [▶▶].

Refer to the table described later for setting items.

7 Exit Display Control mode

Press the [6] ("RTN") button.



- You can switch the information displayed in Upper text display part, Middle text display part and Lower text display part when "Display Type C" is selected.
- You can switch the information displayed in Upper text display part and Lower text display part when "Display Type D" is selected.
- Same information cannot be displayed in Upper text display part, Middle text display part and Lower text display part. However, the blank display is able to have multiple selections.
- Album name cannot be displayed in WMA file. (KDC-MP732 only)

- Track number at Audio file displays the last 3 digits when the track number exceeds 1000 songs. (KDC-X790 only)
- If the contents of the information for the SIRIUS tuner source cannot be displayed, channel number is displayed.
- When LX-AMP is connected, the item setup by the Display mode of LX-AMP is displayed. (KDC-X790 only)

The text display in the Upper text display part

In Tuner source

Information	Display
Station name or *1Program Service name	"SNPS"*
*1Radio text or *1Program Service name (FM)	"Radio Text"*
Frequency	"Frequency"
Clock	"Clock"
Date	"Date"

In CD & External disc source

Information	Display
Disc title	"Disc Title"*
Track title	"Track Title"*
Track number & Play time	"P-Time"
Disc name	"DNPS"
Clock	"Clock"
Date	"Date"

In Audio file source

Information	Display
Song title & Artist name	"Title/Artist"*
Album name & Artist name	"Album/Artist"*
Folder name	"Folder Name"
File name	"File Name"
Play time & File number	"P-Time"
Clock	"Clock"
Date	"Date"

In Standby/ Auxiliary input source

Information	Display
Source name	"Source Name"
Clock	"Clock"
Date	"Date"

In HD Radio source

Information	Display
Station name	"Station Name"*
Title	"Title"*
Frequency	"Frequency"
Clock	"Clock"
Date	"Date"

In SIRIUS tuner source

Information	Display
Channel Name	"Channel Name"
Song Title	"Song Title"
Artist Name	"Artist Name"
Composer name	"Composer Name"
Category Name	"Category Name"
Label Name	"Label Name"
Comment	"Comment"
Band & Channel Number	"Channel Number"
Clock	"Clock"
Date	"Date"



- *¹ KDC-X790 only.
- * If the contents of the information cannot be displayed, Play time or Frequency is displayed.

General features

The text display in the Middle text display part

In Tuner source

Information	Display
Clock	"Clock"
Date	"Date"
Blank	"Blank"
Radio text (FM) (KDC-X790 only)	"Radio Text"*

In CD & External disc source

Information	Display
Clock	"Clock"
Date	"Date"
Blank	"Blank"
Disc title	"Disc Title"*
Track title	"Track Title"*
Disc name	"DNPS"

In Audio file source

Information	Display
Clock	"Clock"
Date	"Date"
Blank	"Blank"
Song title & Artist name	"Title/Artist"*
Album name & Artist name	"Album/Artist"*
Folder name	"Folder Name"
File name	"File Name"

In Standby/ Auxiliary input source

Information	Display
Clock	"Clock"
Date	"Date"
Blank	"Blank"

In HD Radio source

Information	Display
Clock	"Clock"
Date	"Date"
Blank	"Blank"
Title	"Title"*

In SIRIUS tuner source

Information	Display
Clock	"Clock"
Date	"Date"
Blank	"Blank"
Channel Name	"Channel Name"
Song Title	"Song Title"
Artist Name	"Artist Name"
Composer name	"Composer Name"
Category Name	"Category Name"
Label	"Label Name"
Comment	"Comment"



- * If the contents of the information cannot be displayed, Kenwood Logo is displayed. However, in HD Radio source, the display becomes blank.

The text display in the Lower text display part

In Tuner source

Information	Display
Indicator	"Status"
Clock	"Clock"
Date	"Date"
Blank	"Blank"
Radio text (FM) (KDC-X790 only)	"Radio Text"*

In CD & External disc source

Information	Display
Indicator	"Status"
Clock	"Clock"
Date	"Date"
Blank	"Blank"
Disc title	"Disc Title"*
Track title	"Track Title"*
Disc name	"DNPS"

In Audio file source

Information	Display
Indicator	"Status"
Clock	"Clock"
Date	"Date"
Blank	"Blank"
Song title & Artist name	"Title/Artist"*
Album name & Artist name	"Album/Artist"*
Folder name	"Folder Name"
File name	"File Name"

In Standby/ Auxiliary input source

Information	Display
Indicator	"Status"
Clock	"Clock"
Date	"Date"
Blank	"Blank"

In HD Radio source

Information	Display
Indicator	"Status"
Clock	"Clock"
Date	"Date"
Blank	"Blank"
Title	"Title"*

In SIRIUS tuner source

Information	Display
Indicator	"Status"
Clock	"Clock"
Date	"Date"
Blank	"Blank"
Channel Name	"Channel Name"
Song Title	"Song Title"
Artist Name	"Artist Name"
Composer name	"Composer Name"
Category Name	"Category Name"
Label	"Label Name"
Comment	"Comment"



- * If the contents of the information cannot be displayed, indicator is displayed. However, In HD Radio source, a display becomes a blank display.

Display Type B/ Display Type C/ Display Type D

Font Color Select

Selecting the display font color.

1 Select the key function section

Press the [NEXT] button.

Repeatedly press the button until "DISP" is displayed above the [2] button. Refer to <Notes on Multi-function Key System> (page 9).

2 Enter display control mode

Press the [2] ("DISP") button.

3 Select the display mode

Press the [1] ("MODE") button.

4 Select the display Type

Push the Control knob towards [◀◀] or [▶▶].

Select the "Display Type B"/ "Display Type C"/ "Display Type D" display.

5 Enter Font Color select mode

Press the [4] ("COLOR") button.

6 Select the text display part

Select the row (Display Type C/ Display Type D only)

Push the Control knob towards [FM] or [AM].

The cursor (➡) moves to the selected text display part.

Select the Font Color

Push the Control knob towards [◀◀] or [▶▶].

7 Exit display control mode

Press the [6] ("RTN") button.



- When you selected the Display Type B display, select an easy viewable font color.
- The "Status" item of Display type C/D can be set; however, the actual display color does not change.
- This function can be set for each display type.

General features

Display Type E

G-Analyzer display Switching

Alternates G-Analyzer display when the Display type is set to "Display Type E". (G: gravity)



- Before alternating G-Analyzer display, you are required to setup <G-Counter Level set> (page 42), <G-Analyzer Calibration setup> (page 42) and <G-Analyzer Horsepower Gauge setup> (page 43).

1 Select the key function section

Press the [NEXT] button.

Repeatedly press the button until "DISP" is displayed above the [2] button.

Refer to <Notes on Multi-function Key System> (page 9).

2 Enter display control mode

Press the [2] ("DISP") button.

3 Select the display mode

Press the [1] ("MODE") button.

Select the "Display Type E" display.

4 Enter G-Analyzer display select mode

Press the [3] ("GMENU") button.

5 Select the G-Analyzer display

Push the Control knob towards [◀◀] or [▶▶].

G-Force Sensor display

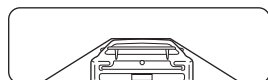

G-Graphic display*

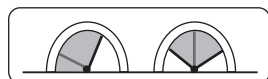

G-Meter display
(Graphic)

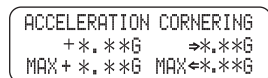

G-Meter display
(Text)



G-Counter display



- G-Graphic display
Displays the condition of G in horizontal direction (e.g. when turning the curve) by the graphic.
- * G-Graphic can be switched to customized pictures.
Refer to <Picture downloading> (page 49) and <G-Graphic Select> (page 44). (KDC-X790 only)
- G-Meter display (Graphic)
Displays the maximum value of acceleration G, right direction G, and left direction G by the numerical value.
- G-Meter display (Text)
The maximum value of acceleration G, right direction G, and left direction G is displayed by the numerical value. The value of G is only the reference, so is different from the actual value.
- G-Counter display
Adds the point of the acceleration level. The point is determined after a lapse of 1 hr drive or at power off (ACC Off), and then it will be displayed by the graph. Furthermore, the G-Counter displays the average of the past data by the line. (The scale of graph is determined along with the largest point among the past 10 data.)
- The value of G-Meter display and G-Counter display can be reset by <G-Analyzer Reset> (page 42).

6 Exit display control mode

Press the [6] ("RTN") button.

Station/Disc Naming (SNPS/DNPS)

Attaching a title to a Station or CD.

1 Receive/play the station/disc you want to attach a title to



- A title cannot be attached to MD or Audio file media.

2 Enter Menu mode

Press the [MENU] button for at least 1 second.

"MENU" is displayed.

3 Select Name set mode

Push the Control knob towards [FM] or [AM].

Select the "Name Set" display.

4 Enter Name set mode

Press the Control knob for at least 1 second.

5 Move the cursor to the enter character position

Push the Control knob towards [◀◀] or [▶▶].

6 Select the character type

Press the Control knob.

Each time you press the knob, the character type alternates between the types shown in the table below.

Character type

Alphabet upper case

Alphabet lower case

Numbers and symbols

Special characters (Accent characters)

7 Select the characters

Push the Control knob towards [FM] or [AM].



- Enter characters by using a remote control with numbers buttons.

Example: If you are entering "DANCE".

Character	Button	Times pressed
"D"	[3]	1
"A"	[2]	1
"N"	[6]	2
"C"	[2]	3
"E"	[3]	2

8 Repeat steps 5 through 7 and enter the name.

9 Exit Menu mode

Press the [MENU] button.



- When operation stops for 10 seconds the name at that time is registered, and Name Set mode closes.
- Memory numbers
 - FM/ AM: 30 stations
 - Internal CD player: 10 discs
 - External CD changer/ player: Varies according to the CD changer/ player. Refer to the CD changer/ player manual.
- Change the title of station/CD by the same operation used to name it.

Tuner features

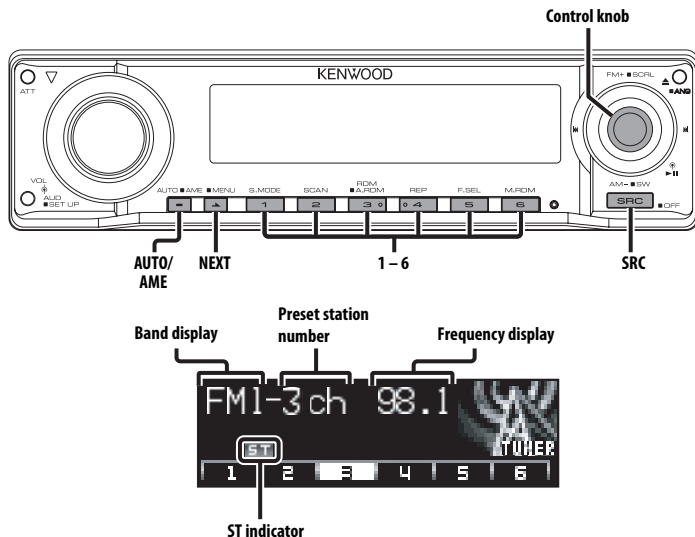

Tuning

Selecting the station.

1 Select tuner source

Press the [SRC] button.

Select the "TUNER" display.

2 Select the band

Push the Control knob towards [FM] or [AM].

Each time you push the knob toward [FM], it switches between the FM1, FM2, and FM3 bands.

3 Tune up or down band

Push the Control knob towards [◀◀] or [▶▶].



- During reception of stereo stations the "ST" indicator is ON.

Tuning Mode

Choose the tuning mode.

Press the [AUTO] button.

Each time you press the button, the Tuning mode alternates between the modes shown in the table below.

Tuning mode	Display	Operation
Auto seek	"Seek Mode Auto1"	Automatic search for a station.
Preset station seek	"Seek Mode Auto2"	Search in order of the stations in the Preset memory.
Manual	"Seek Mode Manual"	Normal manual tuning control.

Function of remote control

Direct Access Tuning

Entering the frequency and tuning.

1 Select the band

Press the [FM] or [AM] button.

2 Enter Direct Access Tuning mode

Press the [DIRECT] button on the remote control.

"- - - -" is displayed.

3 Enter the frequency

Press the number buttons on the remote control.

Example:

Desired frequency	Press button
92.1 MHz (FM)	[0], [9], [2], [1]
810 kHz (AM)	[0], [8], [1], [0]

Cancelling Direct Access Tuning

Press the [DIRECT] button on the remote control.

Station Preset Memory

Putting a station in the memory.

1 Select the band

Push the Control knob towards [FM] or [AM].

2 Select the frequency to put in the memory

Push the Control knob towards [◀◀] or [▶▶].

3 Select the key function section

Press the [NEXT] button.

Repeatedly press the button until "[1]" — "[6]" are displayed above the [1] — [6] buttons.

Refer to <Notes on Multi-function Key System> (page 9).

4 Put the frequency in the memory

Press the desired [1] — [6] button for at least 2 seconds.

The preset number display blinks 1 time.

On each band, 1 station can be put in the memory on each [1] — [6] button.

Auto Memory Entry

Putting stations with good reception in the memory automatically.

1 Select the band for Auto Memory Entry

Push the Control knob towards [FM] or [AM].

2 Open Auto Memory Entry

Press the [AME] button for at least 2 seconds.

When 6 stations that can be received are put in the memory Auto Memory Entry closes.

Preset Tuning

Recalling the stations in the memory.

1 Select the band

Push the Control knob towards [FM] or [AM].

2 Select the key function section

Press the [NEXT] button.

Repeatedly press the button until "[1]" — "[6]" are displayed above the [1] — [6] buttons.

Refer to <Notes on Multi-function Key System> (page 9).

3 Recall the station

Press the desired [1] — [6] button.

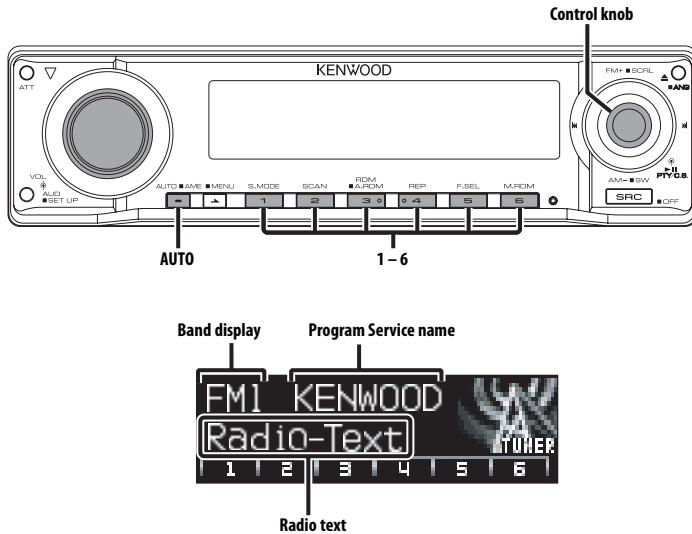

Radio Text Scroll

Scrolling the displayed radio text.

Push the Control knob toward [FM] for at least 2 seconds.



- When the <Display Illumination Control> (page 41) is set to OFF, the display may black out while scrolling.

PTY (Program Type)

Selecting the Program Type and searching for a station.

1 Enter PTY mode

Press the Control knob.

"PTY Select" is displayed.



- The PTY function cannot be used during a traffic bulletin or AM reception.

2 Select the Program Type

Push the Control knob towards [FM] or [AM].

No.	Program Type	Display
1.	Speech	"All Speech"
2.	Music	"All Music"
3.	News	"News"
4.	Information	"Information"
5.	Sports	"Sports"
6.	Talk	"Talk"
7.	Rock	"Rock"
8.	Classic Rock	"Classic Rock"
9.	Adult Hits	"Adult Hits"
10.	Soft Rock	"Soft Rock"
11.	Top 40	"Top 40"
12.	Country	"Country"
13.	Oldies	"Oldies"
14.	Soft	"Soft"
15.	Nostalgia	"Nostalgia"
16.	Jazz	"Jazz"
17.	Classical	"Classical"
18.	R & B	"Rhythm & Blues"
19.	Soft R & B	"Soft R & B"
20.	Language	"Foreign Language"
21.	Religious Music	"Religious Music"
22.	Religious Talk	"Religious Talk"
23.	Personality	"Personality"
24.	Public	"Public"
25.	College	"College"
26.	Weather	"Weather"



- Speech and Music include the Program type below.
Music: No.7 — 19, 21
Speech: No.3 — 6, 20, 22 — 26
- The Program Type can be put in the [1] — [6] button memory and recalled quickly. Refer to the <Program Type preset> (page 27).

3 Search for the selected Program Type station

Push the Control knob towards [◀◀] or [▶▶].

When you want to search for other stations, push toward [◀◀] or [▶▶] of the Control knob again.



- When selected Program Type is not found, "NO PTY" is displayed. Select another Program Type.

4 Exit PTY mode

Press the Control knob.

Registration of a station as a PTY

Registering a Program Type for stations with no PTY data.

1 Receive the station you want to register

2 Select the Program Type to register

Refer to <PTY (Program Type)> (page 26).

3 Register the Program Type

Press the [AUTO] button for at least 2 seconds.

Confirming the Program Type

Press the [AUTO] button.

The Program Type is displayed for 5 seconds.

4 Exit PTY mode

Press the Control knob.

Program Type preset

Putting the Program Type in the Preset button memory and quick recall.

Presetting the Program Type

1 Select the Program Type to preset

Refer to <PTY (Program Type)> (page 26).

2 Preset the Program Type

Press the desired [1] — [6] button for at least 2 seconds.

Recalling the preset Program Type

1 Enter PTY mode

Refer to <PTY (Program Type)> (page 26).

2 Recall the Program Type

Press the desired [1] — [6] button.

CD/Audio file/External disc control features

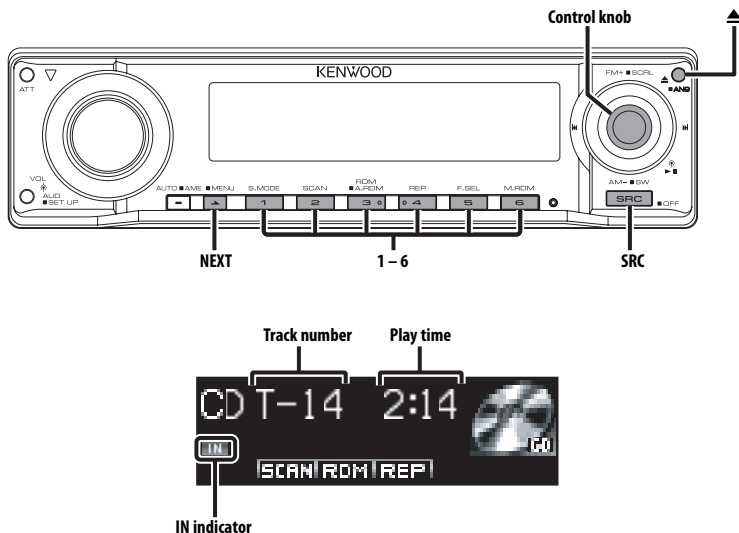

Playing CD & Audio file

When there is no disc inserted

1 Open the panel

Press the [**▲**] button.

2 Insert a disc.



- When the faceplate slides open, it might interfere with the shift lever or other vehicle function. If this happens, pay attention to safety and move the shift lever or take an appropriate action to remove the obstacle, then operate the unit.
- Insert the disc horizontal to the slot. If you insert the Disc as you push down on the Disc, it may scratch the Disc.



- For KDC-X790, you can play the disc (ACDrive disc) made by Media Manager by the same operation.
- You can cancel the announcement when selecting the folder by <Voice Index> (page 50) during the play of the ACDrive. (KDC-X790 only)
- When a disc is inserted the "IN" indicator is ON.

When a disc is inserted

Press the [SRC] button.

Select the "Compact Disc" display.

Pause and play

Press the Control knob.

Each time you press the knob, the audio pauses or plays.

Eject the disc

1 Eject the disc

Press the [**▲**] button.

2 Return the panel to the original position

Press the [**▲**] button.

Playing External Disc

Playing discs set in the optional accessory disc player connected to this unit.

Press the [SRC] button.

Select the display for the disc player you want.

Display examples:

Display	Disc player
"CD Changer"	CD changer
"MD Changer"	MD changer

Pause and play

Press the Control knob.

Each time you press the knob, the audio pauses or plays.



- The functions that can be used and the information that can be displayed will differ depending on the external disc players being connected.

Fast Forwarding and Reversing

Fast Forwarding

Hold down toward [▶▶] with the Control knob.

Release your finger to play the disc at that point.

Reversing

Hold down toward [◀◀] with the Control knob.

Release your finger to play the disc at that point.



- There is no sound while the Audio file is being searched.
- You cannot fast Forwarding and Reversing while AAC file is being played. (KDC-MP732 only)
- You cannot fast Forwarding and Reversing depending on AAC file format. (KDC-X790 only)

Track/File Search

Searching for a song on the disc or in the Audio file folder.

Push the Control knob towards [◀◀] or [▶▶].

Function of disc changer/ Audio file

Disc Search/Folder Search

Selecting the disc set in the Disc changer or the folder recorded on the Audio file media.

Push the Control knob towards [FM] or [AM].

Function of remote control

Direct Track/File Search

Doing Track/File Search by entering the track/file number.

1 Enter the track/file number

Press the number buttons on the remote control.



- You can select Direct File Search up to 999. (KDC-X790 only)

2 Do Track/File Search

Press the [◀◀] or [▶▶] button.

Cancelling Direct Track/File Search

Press the [▶ II] button.

Function of disc changers with remote control

Direct Disc Search

Doing Disc Search by entering the disc number.

1 Enter the disc number

Press the number buttons on the remote control.

2 Do Disc Search

Press the [+] or [-] button.

Cancelling Direct Disc Search

Press the [▶ II] button.

CD/Audio file/External disc control features

Track/File/Disc/Folder Repeat

Replaying the song, disc in the Disc changer or Audio file folder folder you are listening to.

1 Select the key function section

Press the [NEXT] button.

Repeatedly press the button until "REP" is displayed above the [4] button.

Refer to <Notes on Multi-function Key System> (page 9).

2 Turn ON/OFF the Repeat Play

Press the [4] ("REP") button.

Each time you press the button, the Repeat Play alternates between the modes shown in the tables below.

In CD & External disc source

Repeat play	Display
Track Repeat	"Track Repeat ON"
Disc Repeat (In Disc Changer)	"Disc Repeat ON"
OFF	"Repeat OFF"

In Audio file source

Repeat play	Display
File Repeat	"File Repeat ON"
Folder Repeat	"Folder Repeat ON"
OFF	"Repeat OFF"

Scan Play

Playing the first part of each song on the disc or Audio file folder you are listening to and searching for the song you want to hear.

1 Select the key function section

Press the [NEXT] button.

Repeatedly press the button until "SCAN" is displayed above the [2] button.

Refer to <Notes on Multi-function Key System> (page 9).

2 Start Scan Play

Press the [2] ("SCAN") button.

"Scan ON"/ "Track Scan ON"/ "File Scan ON" is displayed.

3 Release it when the song you want to listen to is played

Press the [2] button.

Random Play

Play all the songs on the disc or Audio file folder in random order.

1 Select the key function section

Press the [NEXT] button.

Repeatedly press the button until "RDM" is displayed above the [3] button.

Refer to <Notes on Multi-function Key System> (page 9).

2 Turn ON/OFF the Random Play

Press the [3] ("RDM") button.

Each time you press the button, Random Play turns ON or OFF.

When the Random mode is ON, "Random ON"/ "Disc Random ON"/ "Folder RDM ON" is displayed.



- When you push the Control knob toward [▶▶], the next random song starts.

Function of disc changer

Magazine Random Play

Play the songs on all the discs in the disc changer in random order.

1 Select the key function section

Press the [NEXT] button.

Repeatedly press the button until "M.RDM" is displayed above the [6] button.

Refer to <Notes on Multi-function Key System> (page 9).

2 Turning ON/OFF the Magazine Random Play

Press the [6] ("M.RDM") button.

Each time you press the button, the Magazine Random Play turns ON or OFF.

When the Magazine Random mode is ON, "Magazine RDM ON" is displayed.



- When you push the Control knob toward [▶▶], the next random song starts.

Function of the KDC-X790

Function of Audio file

All Random Play

Playing randomly from all of the Audio files recorded in the disc.

1 Select the key function section

Press the [NEXT] button.

Repeatedly press the button until "RDM" is displayed above the [3] button.

Refer to <Notes on Multi-function Key System> (page 9).

2 Turn ON the All Random Play

Press the [3] ("RDM") button for at least 1 second.

When the random mode is ON, "All Random ON" is displayed.

Canceling the All Random Play

Press the [3] ("RDM") button.



- When you push the Control knob toward [▶▶], the next random song starts.

CD/Audio file/External disc control features

Function of Audio file

Folder Select

Quickly selecting the folder you want to hear.

1 Select the key function section

Press the [NEXT] button.

Repeatedly press the button until "FSEL" is displayed above the [5] button.

Refer to <Notes on Multi-function Key System> (page 9).

2 Enter Folder Select mode

Press the [5] ("FSEL") button.

"FOLDER SELECT" is displayed.

During Select mode the folder information is displayed as shown below.

Folder name display

Displays the current folder name.



Folder number display

Displays the number in the folder belonging to the currently selected folder.



- The Folder select mode does not function when <All Random Play> (page 31) is ON.

3 Select the folder level*

Push the Control knob towards [FM] or [AM].

With the [FM] button, you move 1 level down and with the [AM] button, 1 level up.

Selecting a folder in the same level

Push the Control knob towards [◀◀] or [▶▶].

With the [◀◀] of the Control knob, you move to the previous folder, and with the [▶▶] of the Control knob, to the next folder.

Returning to the top level*

Press the [3] ("HOME") button.



- * You cannot operate this function when <Switching the Play mode> (page 32) is set to other than "Folder Mode" while playing ACDrive.

Scrolling the folder name display

Push the Control knob toward [FM] for at least 2 seconds.

4 Decide the folder to play

Press the [1] ("OK") button.

The Folder Select mode releases, and the Audio file in the folder being displayed plays.

Canceling the Folder Select mode

Press the [2] ("EXIT") button.

Function of the KDC-X790

Function of ACDrive disc

Switching the Play mode

Arrange the playing orders of the songs by categories.

1 Select the key function section

Press the [NEXT] button.

Repeatedly press the button until "S.MODE" is displayed above the [1] button.

Refer to <Notes on Multi-function Key System> (page 9).

2 Select the Play mode

Press the [1] ("S.MODE") button.

Each time you press the button, the Play mode alternates between the modes shown on the table below.

Play mode	Category which is to be arranged
"PlayList Mode"	Play list order.
"Genre Mode"	By genre.
"Artist Mode"	By artist.
"Album Mode"	By album.
"Folder Mode"	By the folder recorded in Disc.



- The category information of each song is the data registered in Media Manager when ACDrive disc is being generated.
- You can cancel the announcement made when the mode is changed by <Voice Index> (page 50).
- You can select the advancement of the Play mode information by [AM] and [FM] knob.

Function of the KDC-X790
Function of ACDrive disc

Letter Seek

You can search for the song, you want to play, by selecting the initial of Genre name, Artist name, or Album name.

1 Select the key function section

Press the [NEXT] button.

Repeatedly press the button until "S.MODE" is displayed above the [1] button.

Refer to <Notes on Multi-function Key System> (page 9).

2 Enter the Letter Seek mode

Press the [1] ("S.MODE") button for at least 1 second.



- This operation does not function when <All Random Play> (page 31) is ON.
- This function is available only when the Play mode is set Genre, Artist, or Album.

Canceling the Letter Seek

Press the [1] ("EXIT") button.

3 Start the Letter Seek

Push the Control knob towards [◀◀] or [▶▶].

The initial of Genre name, Artist name, or Album name is displayed and announced in order.



- The announcement of the initial can be canceled by <Voice Index> (page 50).
- When you push the Control knob to the reverse [◀◀] or [▶▶] during Letter Seek, the initial is displayed and announced in the reversed order.
- Once Letter Seek starts, it cannot be cancelled.

4 Select the song to play

Press the Control knob when the initial of the song you are searching is displayed and announced.

The selected initial group plays.

Text/Title Scroll

Scrolling the displayed CD text, Audio file text, or MD title.

Push the Control knob toward [FM] for at least 2 seconds.



- When the <Display Illumination Control> (page 41) is set to OFF, the display may black out while scrolling.

SIRIUS tuner control features

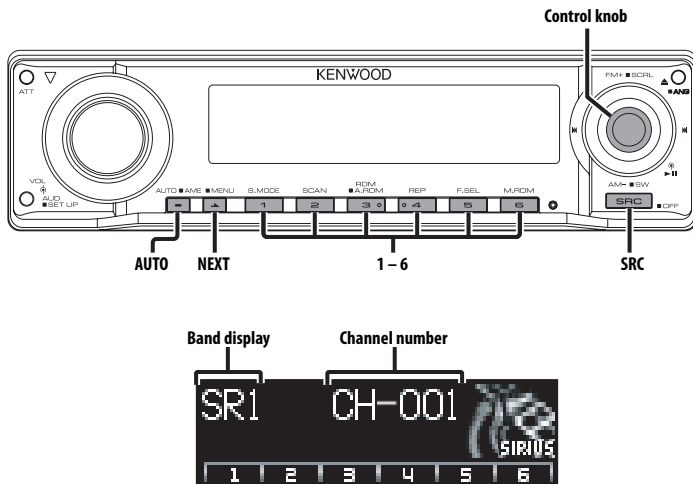

Select SIRIUS Satellite Radio Mode

Selecting the SIRIUS Satellite Radio Tuner (optional accessory) connected to this unit.

Selecting SIRIUS Mode

Press the [SRC] button.

Select the "SIRIUS" display.



- You need to subscribe to SIRIUS to receive the service by SIRIUS Satellite Radio. Consult SIRIUS if "CALL 888-539-SIRIUS TO SUBSCRIBE" appears.
- The radio may take a little time to start receiving after you select the SIRIUS source.
- If the signal reception fails, "Acquiring Signal" appears.

Switching Seek Mode

Sets the seeking mode.

Press the [AUTO] button.

Each time you press the button, the Seek mode alternates between the operations shown in the table below.

Display	Operation
"Seek Mode Channel"	Normal manual seeking control.
"Seek Mode Preset"	Search in order of the channels in the Preset memory.

Select the channel

Selecting the channel.

Push the Control knob towards [◀◀] or [▶▶].

Category and Channel Search

Selecting the channel and category you want to receive.

1 Enter Category and Channel Search mode

Press the Control knob.

2 Select the Category

Push the Control knob towards [FM] or [AM].



- It is the item when the category of Middle text display part is selected.

3 Select the Channel

Push the Control knob towards [◀◀] or

[▶▶].



- You cannot Channel search until the category information is acquired.

Canceling Category and Channel Search mode

Press the Control knob.

Function of remote control

Direct Access Tuning

Entering the channel and tuning.

1 Enter Direct Access Tuning mode

Press the [DIRECT] button on the remote control.

2 Enter the channel

Press the number buttons.

3 Do Channel Search

Push the Control knob towards [◀◀] or

[▶▶].

Canceling Direct Access Tuning

Press the [DIRECT] button on the remote control.



- If you make no button operation for 10 seconds, the Direct Access Tuning mode is automatically canceled.
- You can set up until Channel number 223.
- If there is no signal in the input Channel, "No Channel" appears. (KTC-SR901: optional accessory)

- You cannot search for a channel number which is not broadcasting.
(KTC-SR902/KTC-SR903: optional accessory)
- If you cannot receive any signal in the input Channel due to bad conditions on radio wave or other such problems, "Acquiring Signal" appears.

Selecting the Preset Band

Push the Control knob toward [FM].

Each time you push the knob, the preset band alternates between the SR1, SR2, SR3 and SR4.

Channel Preset Memory

Putting the channel in the memory.

1 Select the preset band

Push the Control knob toward [FM].

2 Select the channel to put in the memory

Push the Control knob towards [◀◀] or [▶▶].

3 Select the key function section

Press the [NEXT] button.

Repeatedly press the button until "[1]" — "[6]" are displayed above the [1] — [6] buttons.

Refer to <Notes on Multi-function Key System> (page 9).

4 Put the channel in the memory

Press the desired [1] — [6] button for at least 2 seconds.

The preset number display blinks 1 time.

On each band, you can put 1 channel in the memory on each [1] — [6] button.



- Only the channel number is stored. Category information is not stored.

SIRIUS tuner control features

Preset Tuning

Recalling the channels in the memory.

1 Select the preset band

Push the Control knob toward [FM].

2 Select the key function section

Press the [NEXT] button.

Repeatedly press the button until "[1]" — "[6]" are displayed above the [1] — [6] buttons.

3 Recall the channel

Press the desired [1] — [6] button.

Channel Scan

Checks every receivable Channel for 10 seconds.

1 Start Channel Scan

Press the [AUTO] button for at least 2 seconds.

The channel number display blinks.

2 Release the button when the song you want to hear is received

Press the [AUTO] button for at least 2 seconds.

Text Scroll for SIRIUS tuner source

Scrolls the displayed channel name and other items.

Push the Control knob toward [FM] for at least 2 seconds.



- When the <Display Illumination Control> (page 41) is set to OFF, the display may black out while scrolling.

HD Radio control features

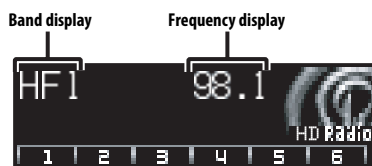
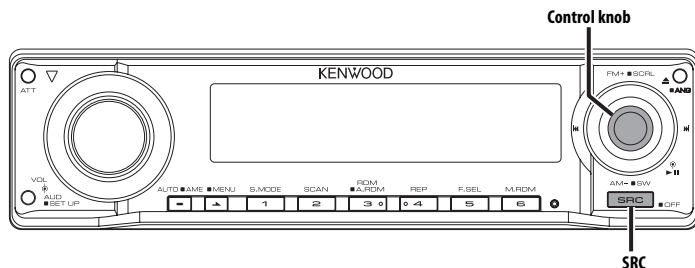

About HD Radio

- When you connect an HD Radio, Tuner features of the unit are disabled and changed to HD Radio tuner features. A portion of the setting methods including the Tuning Mode will change.
- With the HD Radio tuner, you can use the similar functions to <Station Preset Memory>, <Auto Memory Entry>, and <Preset Tuning> of Tuner features. Refer to Tuner features for how to use the functions.

Tuning

Selecting the station.

1 Select HD Radio source

Press the [SRC] button.

Select the "HD Radio" display.

2 Select the HD FM band

Push the Control knob toward [FM].

Each time you push the knob to [FM], the band alternates between the HF1, HF2, and HF3 bands.

Select the HD AM band

Push the Control knob toward [AM].

3 Tune up or down band

Push the Control knob towards [◀◀] or [▶▶].

Menu system

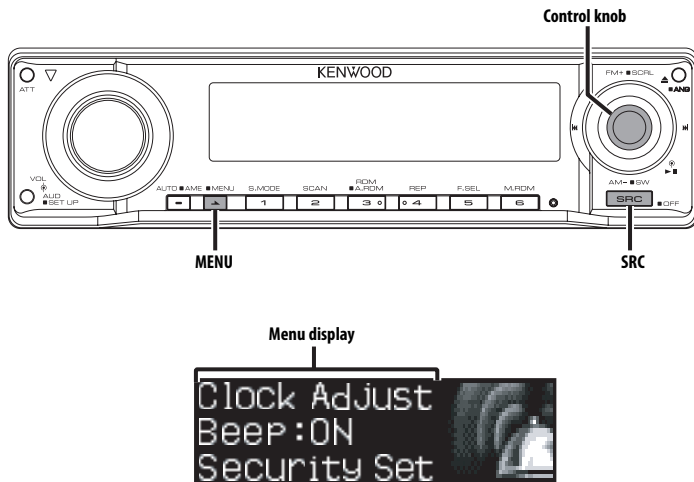

Menu System

Setting beep sound during operation, etc. functions.

The Menu system basic operation method is explained here. The reference for the Menu items and their setting content is after this operation explanation.

1 Enter Menu mode

Press the [MENU] button for at least 1 second.
"MENU" is displayed.

2 Select the menu item

Push the Control knob towards [FM] or [AM].
Example: When you want to set the beep sound select the "Beep" display.

3 Set the menu item

Push the Control knob towards [◀◀] or [▶▶].
Example: When you select "Beep", each time you push the knob it alternates between "Beep : ON" or "Beep : OFF". Select 1 of them as the setting.

You can continue by returning to step 2 and setting other items.

4 Exit Menu mode

Press the [MENU] button.



- When other items those applicable to the basic operation method above are displayed, their setting content chart is entered. (Normally the setting listed at the top of the chart is the original setting.) Also, the explanation for items that are not applicable (<Manual Clock Adjustment> etc.) are entered step by step.
- Three menu items appear on the display. The menu item displayed at the center is the one you can adjust.

In Standby mode

Activating Security Code

Activating the Security Code disables the usage of audio unit by someone else. Once the Security Code is activated, the entry of authorized Security Code is required to turn on the audio unit when it is removed from the vehicle. Indication of this Security Code activation prevents your precious audio unit from stealing.



- Set the Security Code when the <Demonstration mode Setting> (page 51) is set to OFF.
- You can set the Security Code with a 4 digit number of your choice.
- The Security Code cannot be displayed or referenced. Make a note of the Security Code and treasure it up.

1 Enter Standby

Press the [SRC] button.

Select the "STANDBY" display.

2 Enter Menu mode

Press the [MENU] button for at least 1 second.

When "MENU" is displayed, "Security Set" is also displayed.

3 Enter Security Code mode

Press the Control knob for at least 1 second.

When "Enter" is displayed, "Security Set" is also displayed.

4 Select the digits to enter

Push the Control knob towards [◀◀] or [▶▶].

5 Select the Security Code numbers

Push the Control knob towards [FM] or [AM].

6 Repeat steps 4 and 5, and complete the Security Code.

7 Confirm the Security Code

Press the Control knob for at least 3 seconds.

When "Re-Enter" is displayed, "Security Set" is also displayed.

8 Do the step 4 through 7 operation, and reenter the Security Code.

"Approved" is displayed.

The Security Code function activates.

9 Exit Security Code mode

Press the [MENU] button.



- If you enter the wrong Code in steps 4 through 6, repeat from step 4.

Resetting the Security Code function when the audio unit is first used after removed from the battery power source or the Reset button is pressed

1 Turn the power ON.

2 Do the step 4 through 7 operation, and enter the Security Code.

"Approved" is displayed.

Now, you can use the unit.



- When the Security Code function is activated, "Security Set" changes to "Security Clear".
- To deactivate the Security Code function, see the next section <Deactivating Security Code>.

In Standby mode

Deactivating Security Code

To deactivate the Security Code function.

1 Select Security Code mode

Push the Control knob towards [FM] or [AM].

Select the "Security Clear" display.

2 Enter Security Code mode

Press the Control knob for at least 1 second.

When "Enter" is displayed, "Security Set" is also displayed.

3 Select the digits to enter

Push the Control knob towards [◀◀] or [▶▶].

4 Select the Security Code numbers

Push the Control knob towards [FM] or [AM].

5 Repeat steps 3 and 4, and complete the Security Code.

6 Press the Control knob for at least 3 seconds.

"Clear" is displayed.

The Security Code function deactivates.



- If a wrong security code is entered, "Error" is displayed. Enter a correct security code.

Menu system

In Standby mode

Touch Sensor Tone

Setting the operation check sound (beep sound) ON/OFF.

Display	Setting
"Beep : ON"	Beep is heard.
"Beep : OFF"	Beep canceled.

In Standby mode

Manual Clock Adjustment



- You can do this adjustment when the <Synchronize Clock> (page 41) is set as OFF. (KDC-X790 only)

1 Select Clock Adjustment mode

Push the Control knob towards [FM] or [AM].
Select the "Clock Adjust" display.

2 Enter Clock Adjust mode

Press the Control knob for at least 1 second.
The clock display blinks.

3 Adjust the hours

Push the Control knob towards [FM] or [AM].

Adjust the minutes

Push the Control knob towards [◀◀] or [▶▶].

4 Exit Clock adjustment mode

Press the [MENU] button.

In Standby mode

Date Adjustment

1 Select Date Adjust mode

Push the knob towards [FM] or [AM].
Select the "Date Adjust" display.

2 Enter Date Adjust mode

Press the Control knob for at least 1 second.
The date display blinks.

3 Selecting the item (day, month, or year) to adjust

Push the Control knob towards [◀◀] or [▶▶].

The items that are blinking are items that you can adjust.

4 Adjust each item

Push the Control knob towards [FM] or [AM].

5 Repeat step 3 and 4 operation and adjust the date.

6 Exit Date adjustment mode

Press the [MENU] button.

In Standby mode

Date Mode

Setting the date format.

1 Select Date Mode

Push the Control knob towards [FM] or [AM].
Select the "Date Mode" display.

2 Select the date format

Push the Control knob towards [◀◀] or [▶▶].

3 Exit Menu mode

Press the [MENU] button.

Function of the KDC-X790
In Standby mode

Synchronize Clock

Synchronizing the RDS station time data and this unit's clock.

Display	Setting
"SYNC : OFF"	Adjust the time manually.
"SYNC : ON"	Synchronizes the time.



- It takes 3 to 4 minutes to synchronize the clock.

In Standby mode

DSI (Disabled System Indicator)

A red indicator will blink on the unit after the faceplate is removed, warning potential thieves.

Display	Setting
"DSI : ON"	LED flashes.
"DSI : OFF"	LED OFF.

In Standby mode

Selectable Illumination

Selecting the button illumination color as green or red.

Display	Setting
"Button : Red"	The illumination color is red.
"Button : Green"	The illumination color is green.

Display Illumination Control

This function turns off the display when you perform no operation for 5 seconds. This function is effective when you are driving at night.

Display	Setting
"Display : ON"	Keeps the display on.
"Display : OFF"	Turns off the display when you perform no operation for 5 seconds.



- Set the Display Illumination Control when the <Demonstration mode Setting> (page 51) is set to OFF.
- When the display is off, pressing any key will turn on the display.
- When the display is off, you cannot perform any operation except for the following:
 - Volume
 - Attenuator
 - Selecting the source
 - Ejecting the disc
 - Faceplate Angle Adjustment
 - Turning off the power
- During function control, such as the Menu System, the display stays on.

In Standby mode

Dimmer

Dimming this unit's display automatically when the vehicle light switch is turned ON.

Display	Setting
"Dimmer : ON"	The display dims.
"Dimmer : OFF"	The display doesn't dim.

In Standby mode

Built-in Amp Setting

Controlling the built-in amplifier.
Turning OFF this control enhances the preout quality.

Display	Setting
"AMP : ON"	The built-in amplifier activates.
"AMP : OFF"	The built-in amplifier deactivates.

Menu system

In Standby mode

G-Counter Level set

Calibrating G-Point. Setting the level according to the kinds of vehicles.

Display	Setting
"G-Counter : Level1"	Counter is easy to go up.
"G-Counter : Level2"	:
"G-Counter : Level3"	Counter is hard to go up.



- In the case of driving situations calling for few accelerations, set the G-Point up to "G-Counter : Level1". In the case of frequent accelerations, set it up to "G-Counter : Level3".

In Standby mode

G-Analyzer Reset

Resets the value of G-Meter, G-Counter and G-Analyzer Horsepower Analysis.

- 1 Select G-Analyzer Reset mode**
Push the Control knob towards [FM] or [AM].
Select the "G-Reset" display.
- 2 Enter G-Analyzer Reset mode**
Press the Control knob for at least 1 second.
- 3 Select the Reset item**
Push the Control knob towards [FM] or [AM].
"G-Meter Reset": Reset the value of G-Meter.
"G-Counter Reset": Reset the value of G-Counter.
"G-Power Reset": Reset the value of G-Analyzer Horsepower Analysis.
- 4 Reset the value**
Press the Control knob for at least 2 seconds.
"Reset OK" is displayed.
- 5 Exit G-Analyzer Reset mode**
Press the [MENU] button.

In Standby mode

G-Analyzer Calibration setup

G-Analyzer requires calibration for horizontal acceleration and braking.



- To ensure accurate calibration, go through the following steps at a level place where you can move the vehicle straight ahead.

- 1 Park the vehicle in a horizontal location**
- 2 Select G-Analyzer Calibration setup mode**
Push the Control knob towards [FM] or [AM].
Select the "G-Calibration" display.
- 3 Enter G-Analyzer Calibration setup mode**
Press the Control knob for at least 1 second.
"Stop" is displayed.
- 4 Start Calibration of horizontal direction**
Press the Control knob.
Once "Move Forward" appears on the display, the vehicle must be advanced.
- 5 Start Calibration of straight direction**
Start moving the vehicle ahead.
Calibration of straight direction automatically starts.
When the Calibration is finished, "Calibration OK" is displayed.

 - If you fail to complete the calibration, "No Calibration" is displayed. In such a case, repeat steps 1 through 6.
- 6 Exit G-Analyzer Calibration setup mode**
Press the [MENU] button.

In Standby mode

G-Analyzer Horsepower Gauge setup

Enter vehicle class and weight to calculate horsepower.

1 Select the G-Analyzer Horsepower Gauge setup mode

Push the Control knob towards [FM] or [AM].
Select the "Hp Gauge Setup" display.

2 Enter G-Analyzer Horsepower Gauge setup mode

Press the Control knob for at least 1 second.
"Class Select" is displayed.

3 Select vehicle class

Push the Control knob towards [◀◀] or [▶▶].

Each time you push the knob, the vehicle class alternates between the modes shown in the table below.

Display
"Mid Size"
"Full Size"
"SUV"
"Van/ Mini-Van"
"Pickup Truck"
"Sporty"
"Compact"

4 Enter Weight Input mode

Press the Control knob.
"Weight Input" is displayed.

5 Select the weight numbers

Push the Control knob towards [FM] or [AM].



- The weight input range is between 1000-9999 lbs.

6 Select the digits to enter

Push the Control knob towards [◀◀] or [▶▶].

7 Repeat steps 5 and 6, and complete the weight input.

8 Exit G-Analyzer Horsepower Gauge setup mode

Press the [NEXT] button.

G-Analyzer Horsepower Analysis

This measures the horsepower and displays graph and max power. It automatically saves the highest record.



- Do not use G-Analyzer Horsepower Analysis on the Public roads.
- Do not use this product in any way that prevents you from driving safely.
- Follow all driving laws and use common sense when using this product.



- Before alternating G-Analyzer Horsepower Analysis, you are required to setup <G-Analyzer Horsepower Gauge setup> (page 43).

1 Select the G-Analyzer Horsepower Analysis mode

Push the Control knob towards [FM] or [AM].

Select the "Horsepower" display.

2 Enter G-Analyzer Horsepower Analysis mode

Press the Control knob for at least 1 second.

"Stop" is displayed.

Previous max power and record are displayed.

3 Begin measurement

Press the Control knob.

"Ready" is displayed.

4 Start the car

"Measure" is displayed.

After 15 seconds of measurement, the result is displayed.

Display the result

The graph shows the variation in horsepower between 0.1 to 15.0 seconds. The maximum power is displayed in red and the markings provided at intervals of 5 seconds are displayed in blue.



- Pressing the Control knob also begins the measurement. To prevent danger, push the control knob before starting the car.

5 To display the maximum power in the section:

Push the Control knob towards [◀◀] or [▶▶].

Each time you push the Control knob, the maximum power in the section is displayed.

6 Exit G-Analyzer Horsepower Analysis mode

Press the [NEXT] button.



- Like your vehicle's speedometer, G-Analyzer is no more than a measuring function. The HP or G value measured by this unit may not be completely accurate due to its simplified method of measurement. The G-Analyzer is only for reference and should not be used to confirm the horsepower specifications of your vehicle.
- Measuring after starting the car lowers the accuracy.
- The record will not be renewed if the measurement is discontinued.
- The graph's scale adjusts automatically to the horsepower value.
- The value of max power and record can be reset by <G-Analyzer Reset> (page 42).

*Function of the KDC-X790
In Standby mode*

G-Graphic Select

Select the picture to display on G-Graphic.

Display	Setting
"G-Graph : Default"	Display default picture.
"G-Graph : Custom"	Display downloaded picture.



- G-Graphic pictures cannot be selected unless downloaded beforehand. To download G-Graphic pictures, refer to <Picture downloading> (page 49)

G-Analyzer Stop Watch

The control of stop watch can be started by G-Analyzer function.



- Do not use G-Analyzer stop watch on the Public roads.

1 Select G-Analyzer Stop Watch mode Push the Control knob towards [FM] or [AM].

Select the "Stop Watch" display.

2 Enter G-Analyzer Stop Watch mode Press the Control knob for at least 1 second.

"Stop" is displayed.

3 Enter Counter Ready mode Press the Control knob.

"Ready" is displayed.

4 Start Count

When G in the vertical direction is detected during the travel, the count automatically starts. "Running" is displayed.



- You can also start the counter by pressing the Control knob.

5 Stop Count Press the Control knob.

"Stop" is displayed.



- The control will start again when you accelerate or press the Control knob.
Do the operation after step3.

When you Reset the Count (While "Stop" is displayed)

Press the Control knob for at least 2 seconds.



- You can reset of count when the count is stopped.

6 Exit G-Analyzer Stop Watch mode Press the [MENU] button.



- When "Running" is displayed (counted), the count is continued even though G-Analyzer Stop Watch mode is finished. If you want to stop the count, enter the menu mode then press the control knob.
- When Power off (ex; ACC OFF) while counting, the value of 1 second or less will be "00".

*Other than Standby mode/
When the Dual Zone System is ON*

Dual Zone System Setting

Setting the Front channel and Rear channel sound in the Dual Zone System.

Display	Setting
"Zone 2 : Rear"	Sub source (Auxiliary input source) is to be rear channel.
"Zone 2 : Front"	Sub source (Auxiliary input source) is to be front channel.

Menu system

Function of the KDC-MP732
In Audio file source

Supreme Setting

When AAC, MP3 or WMA files encoded at a low bit rate (less than 96kbps (fs=32k, 44.1k, 48kHz)) are played, this function restores their high frequency region to approach the sound quality of equivalents of these files encoded at a high bit rate. Processing is optimized for the compression format used (AAC, MP3, or WMA), and adjustment is made for the bit rate used.

Display	Setting
"Supreme : ON"	Plays sound using the Supreme function.
"Supreme : OFF"	Plays the original sound stored in the audio file.



- The sound effect may be imperceptible depending on the relationship between the audio file format and setting.

Function of the KDC-X790
Other than Standby mode

B.M.S. (Bass Management System)

Adjust the bass boost level of the external amplifier using the main unit.

Display	Setting
"AMP Bass : Flat"	Bass boost level is flat.
"AMP Bass : +6"	Bass boost level is low (+6dB).
"AMP Bass : +12"	Bass boost level is mid (+12dB).
"AMP Bass : +18"	Bass boost level is high (+18dB).



- Refer to the catalog or instruction manual for power amplifiers that can be controlled from this unit.
- For amplifiers, there are the models you can set from Flat to +18 dB, and the models you can set from Flat to +12 dB.
When an amplifier that can only be set to +12 is connected to the unit, "AMP Bass : +18" will not work correctly even if it is selected.

Function of the KDC-X790
Other than Standby mode

B.M.S. Frequency Offset

Setting the central frequency, boosted by B.M.S.

Display	Setting
"AMP FREQ : Normal"	Boost with the normal central frequency.
"AMP FREQ : Low"	Drop the normal central frequency 20%.

Function of the KDC-X790
When LX AMP unit connecting

AMP Control

You can control the LX AMP connected to the unit.

1 Select AMP Control mode

Push the Control knob towards [FM] or [AM].

Select the "AMS Control" display.

2 Enter AMP Control mode

Press the Control knob for at least 1 second.

3 Select the AMP Control item for adjustment

Push the Control knob towards [FM] or [AM].



- For the details on the AMP Control item, see the Instruction manual attached to the LX AMP.

4 Adjust the AMP Control item

Push the Control knob towards [◀◀] or [▶▶].

5 Exit AMP Control mode

Press the [MENU] button.



- You cannot use the LX AMP operation during standby mode.

Function of the KDC-X790
Other than Standby mode

Traffic Information

Switching to traffic information automatically when a traffic bulletin starts even when you aren't listening to the radio.

Display	Setting
"TI : OFF"	The Traffic Information function is OFF.
"TI : ON"	The Traffic Information function is ON.

When a traffic bulletin starts, "Traffic INFO" is displayed and it switches to traffic information.



- During reception of an AM station when the Traffic Information function is turned ON, it switches to an FM station.
- During reception of traffic information the adjusted volume is automatically remembered, and the next time it switches to traffic information it's automatically the remembered volume.

Receiving other traffic information stations (In tuner source)

Push the Control knob towards [◀◀] or [▶▶].



- You can change the traffic information station when listening to the radio.

In FM reception

CRSC (Clean Reception System Circuit)

Temporarily have reception alternate from stereo to mono to reduce multi-path noise when listening to the FM station.

Display	Setting
"CRSC : ON"	The CRSC is ON.
"CRSC : OFF"	The CRSC is OFF.



- Strong electrical fields (such as from power lines) may cause unstable sound quality when CRSC is turned ON. In such a situation, turn it OFF.

In HD Radio mode

Receive mode Setting

Sets the receive mode.

1 Select the Receive mode

Push the Control knob towards [FM] or [AM].
Select the "Receive Mode" display.

2 Enter Receive mode

Press the Control knob for at least 1 second.

3 Set the Receive mode

Push the Control knob towards [FM] or [AM].

Each time you push the knob, the Receive mode alternates between the modes shown in the table below.

Receive mode	Display	Operation
Auto mode	"Auto"	Analog broadcasts and digital broadcasts will be switched automatically. When both are being transmitted, the digital broadcast will have priority.
Digital	"Digital"	Digital broadcasts only.
Analog	"Analog"	Analog broadcasts only.

4 Exit Receive mode

Press the [MENU] button.



- Even if the Receive mode is set to "Auto", when the Ball game mode program (non-delayed broadcast program) is received, the Receive mode will automatically switch to Analog broadcast only.

In SIRIUS tuner source

SIRIUS ID (ESN) display

Displaying the SIRIUS ID (Electronic Serial Number).

Display
"ESN =*****"



Serial & SIRIUS ID (ESN)

It is important to retain the unit serial number and the electronic SIRIUS Identification number for service activation and potential service changes.

Menu system

Auxiliary Input Display Setting & Station/Disc Naming

Selecting the display when changing to Auxiliary input source. For the Station/Disc Naming refer to the <Station/Disc Naming (SNPS/DNPS)> (page 23).

1 Select Auxiliary input source

Press the [SRC] button.

Select the "AUX"/ "AUX EXT" display.

2 Enter Menu mode

Press the [MENU] button for at least 1 second.

"MENU" is displayed.

3 Select Auxiliary input display setting mode

Push the Control knob towards [FM] or [AM].

Select the "Name Set" display.

4 Enter Auxiliary input display setting mode

Press the Control knob for at least 1 second.

The presently selected Auxiliary input display is displayed.

5 Select the Auxiliary input display

Push the Control knob towards [◀◀] or [▶▶].

Each time you push the knob, the display alternates as listed below.

- "AUX"/ "AUX EXT"
- "DVD"
- "PORTABLE"
- "GAME"
- "VIDEO"
- "TV"

6 Exit Menu mode

Press the [MENU] button.



- When operation stops for 10 seconds, the name at that time is registered, and the Auxiliary input display setting mode closes.
- The Auxiliary Input Display can be set only when the built-in auxiliary input or the auxiliary input of optional KCA-S210A is used.

Text Scroll

Setting the displayed text scroll.

Display	Setting
"Scroll : Auto"	Repeats scroll.
"Scroll : Manual"	Scrolls when the display changes.



- The text scrolled is listed below.
 - CD text
 - Folder name/ File name/ Song title/ Artist name/ Album name
 - MD title
 - Radio text
 - Text for the SIRIUS tuner source, HD Radio source, including Channel name, etc.

In Standby mode

Built-in Auxiliary input Setting

Set the Built-in Auxiliary Input function.

Display	Setting
"Built in AUX : OFF"	When selecting the source there's no Auxiliary Input.
"Built in AUX : ON"	When selecting the source there's Auxiliary Input.

In Standby mode

CD Read Setting

When there is a problem with playing a CD with special format, this setting plays the CD by force.

Display	Setting
"CD Read : 1"	Play CD and Audio file.
"CD Read : 2"	Play CD by force.



- Setting "CD Read : 2" cannot play Audio file. Some music CDs may not play even in the "CD Read : 2" mode.

Function of the KDC-X790
In Standby mode

Picture downloading

Downloading movies, wallpapers and G-Graphic. You can use downloaded pictures for the display of this unit.

1 Insert a CD-R/CD-RW.

Insert a CD-R/CD-RW containing files to be downloaded into this unit.
Refer to <Playing CD & Audio file> (page 28) for details.
Our URL <http://www.kenwood.net-disp.com> describes how to make CD-R/CD-RW.

2 Enter Standby

Press the [SRC] button.
Select the "STANDBY" display.

3 Enter Menu mode

Press the [MENU] button for at least 1 second.
"MENU" is displayed.

4 Select the downloading mode

Push the Control knob towards [FM] or [AM].
Select the "DISP Data DL" display.

5 Enter the downloading mode

Press the Control knob for at least 1 second.
"File Check!!" is displayed.

6 Select files to be downloaded

Push the Control knob towards [◀◀] or [▶▶].

7 Start downloading

Press the Control knob for at least 2 seconds.
"Downloading" is displayed.
When the downloading finishes, "Finished Download" is displayed.



- Picture downloading may take as long as 10 minutes.

Quantity
(Movie, Picture)



Canceling Downloading

Press the [MENU] button.

8 Exit the downloading mode

Press the [MENU] button.



- Do not operate this unit, while "Downloading" is displayed to prevent data from being damaged.
- The number of files that can be downloaded.
 - Downloaded movie: 1 file
 - Wallpaper: 1 file
 - G-Graphic: 1 file
- When you download a new movie, it is overwritten to the currently downloaded movie.
Also, when a new wallpaper is downloaded, it is overwritten to the currently downloaded wallpaper.
There is no way to delete the downloaded pictures.
- The downloaded pictures can be used for display.
 - <Graphic part Display Switching> (page 15)
 - <Wallpaper selecting> (page 16)
 - <G-Graphic Select> (page 44)
- When you cannot download the pictures to this unit, there may be a problem with the CD-R/CD-RW write method.
Refer to the URL <http://www.kenwood.net-disp.com>, and rewrite the CD-R/CD-RW.

PICTURE ENGINE

Picture Engine is an application software distributed from Kenwood's official website. Utilizing this software, you can create an original still image file. As for the download of application, please browse "<http://www.kenwood.net-disp.com/>" for directions.

Menu system

Function of the KDC-X790
Function of ACDrive disc

Voice Index

Setting the announcement during the play of ACDrive disc.

Display	Setting
"Voice Index : ON"	Guide is announced.
"Voice Index : OFF"	Not be announced.

Function of the KDC-X790
In CD mode

ACDrive firmware version display

Displaying the firmware version with the ACDrive function.

- 1 Select the firmware version display mode**
Push the Control knob towards [FM] or [AM].
Select the "ACD F/W Version" display.
- 2 Display the ACDrive firmware version**
Push the Control knob towards [◀◀] or [▶▶].

Function of the KDC-X790
In CD mode

Unique ID display

Displaying the serial number for each product.

- 1 Select the unique ID display mode**
Push the Control knob towards [FM] or [AM].
Select the "ACD Unique ID" display.
- 2 Display the unique ID**
Push the Control knob towards [◀◀] or [▶▶].

Other than Standby mode

Audio Preset Memory

Registering the value setup by Sound Control. The memory cannot be erased by the Reset button.

1 Setup Sound Control

Refer to the following operations to setup the Sound Control.

- <Audio Control> (page 11)
- <Audio Setup> (page 12)

2 Enter Menu mode

Press the [MENU] button for at least 1 second.

"MENU" is displayed.

3 Select Audio Preset mode

Push the Control knob towards [FM] or [AM].

Select the "Audio Preset" display.

4 Enter Audio Preset mode

Press the Control knob for at least 1 second.

5 Select the Audio Preset Memory

Push the Control knob towards [FM] or [AM].

Select the "Memory" display.

6 Put the Audio Preset in the memory

Press the Control knob for at least 2 seconds.

The "Memory" display blinks 1 time.

7 Exit Audio Preset mode

Press the [MENU] button.



- Register 1 pair of Audio Preset Memory. You cannot register by the source.
- When you press the Reset, all the sources will be the setting value which is registered.
- The following items cannot be registered.
Volume, Balance, Fader, Loudness, Volume offset, Dual Zone System, Rear Volume

Other than Standby mode

Audio Preset Recall

Recalling the sound setup registered by <Audio Preset Memory> (page 50).

1 Select the source

Press the [SRC] button.

2 Enter Menu mode

Press the [MENU] button for at least 1 second.
"MENU" is displayed.

3 Select Audio Preset mode

Push the Control knob towards [FM] or [AM].
Select the "Audio Preset" display.

4 Enter Audio Preset mode

Press the Control knob for at least 1 second.

5 Select the Audio Preset Recall

Push the Control knob towards [FM] or [AM].
Select the "Recall" display.

6 Recall the Audio Preset

Press the Control knob for at least 2 seconds.
The "Recall" display blinks 1 time.

7 Exit Audio Preset mode

Press the [MENU] button.



- The User memory of <System Q> (page 11) is changed to the value which was recalled.
- The source tone memory item of <Audio Control> (page 11) is changed to the value which was recalled by the selected source.

In Standby mode

Demonstration mode Setting

Sets the demonstration mode.

1 Select the Demonstration mode

Push the Control knob towards [FM] or [AM].
Select the "DEMO Mode" display.

2 Set the Demonstration mode

Press the Control knob for at least 2 seconds.
Each time you press the knob at least 2 seconds, the Demonstration mode alternates between the settings shown in the table below.

Display	Setting
"DEMO Mode : ON"	The Demonstration mode function is ON.
"DEMO Mode : OFF"	Exit Demonstration mode (Normal mode).

Basic Operations of remote control

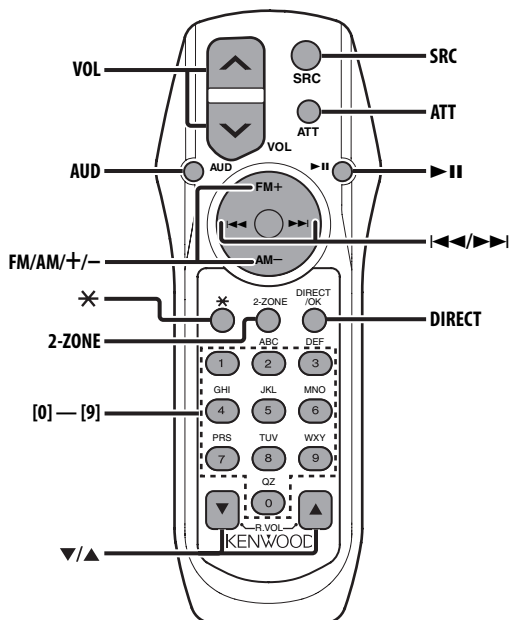

Loading and Replacing the battery

Use two "AA"/ "R6"-size batteries.

Slide the cover while pressing downwards to remove it as illustrated.

Insert the batteries with the + and - poles aligned properly, following the illustration inside the case.

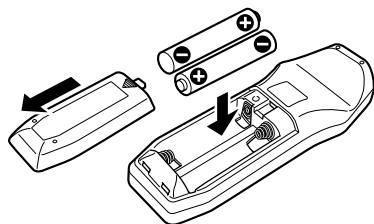

▲WARNING

- Store unused batteries out of the reach of children. Contact a doctor immediately if the battery is accidentally swallowed.



- Do not set the remote control in hot places such as above the dashboard.

Basic operations

[VOL] buttons

Adjusts the volume.

[SRC] button

Each time you press the button, the source alternates.

For the source alternating order refer to <Selecting the Source> (page 10).

[ATT] button

Turns the volume down quickly.

When the button is pressed again, the volume returns to the previous level.

[*] button

Adjusts the Faceplate Angle.

Audio Control

[AUD] button

Selects the Audio item to be adjusted.

[VOL] buttons

Adjusts the Audio item.



- Refer to <Audio Control> (page 11) for the operation method, such as the procedures for Audio control and others operations.
- The remote control can only select and adjust the Basic Audio item. Selecting and adjusting of the Detail Audio item cannot be done.

Dual Zone System

[2-ZONE] button

Each time you press the button, "2 ZONE" of <Audio Setup> (page 12) is turned ON or OFF.

[▲]/ [▼] buttons

Adjusts the volume of the rear channel. The rear channel activates while the Dual Zone System is ON.

In Tuner source

[FM]/ [AM] buttons

Selects the band.

Each time you press the [FM] button, the band alternates between the FM1, FM2, and FM3 bands.

[◀◀]/ [▶▶] buttons

Tune up or down band.

[0] — [9] buttons

Press buttons [1] — [6] to recall preset stations.

[DIRECT] button

Enters and cancels the <Direct Access Tuning> (page 25) mode.

[▶II] button

Enters and cancels the <PTY (Program Type)> (page 26) mode.

In Disc source

[◀◀]/ [▶▶] buttons

Going forwards and backwards between track/ files.

[+]/ [-] buttons

Going forwards and backwards between disc/ folders.

[▶II] button

Each time you press the button, the song pauses or plays.

[0] — [9] buttons

When in <Direct Track/File Search> (page 29) and <Direct Disc Search> (page 29), enters the track/ file/disc number.

Basic Operations of remote control

In SIRIUS tuner source

[FM] button

Selects the preset band.

[◀◀]/ [▶▶] buttons

Searches up or down channels.

[0] — [9] buttons

Press buttons [1] — [6] to recall preset channels.

[DIRECT] button

Enters and cancels the <Direct Access Tuning> (page 35) mode.

In HD Radio source

[FM] button

Selects the HD FM band.

Each time you press the [FM] button, the band alternates between the HF1, HF2, and HF3 bands.

[AM] button

Selects the HD AM band.

[◀◀]/ [▶▶] buttons





Tunes up or down bands.

[0] — [9] buttons

Press buttons [1] — [6] to recall preset stations.

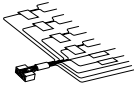
Accessories/ Installation Procedure

Accessories

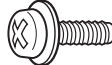
①	1
②	2
③	4
④	4
⑤	1

Installation Procedure

1. To prevent a short circuit, remove the key from the ignition and disconnect the \ominus battery.
2. Make the proper input and output wire connections for each unit.
3. Connect the speaker wires of the wiring harness.
4. Connect the wiring harness wires in the following order: ground, battery, ignition.
5. Connect the wiring harness connector to the unit.
6. Install the unit in your car.
7. Reconnect the \ominus battery.
8. Press the reset button.

⚠ WARNING

If you connect the ignition wire (red) and the battery wire (yellow) to the car chassis (ground), you may cause a short circuit, that in turn may start a fire. Always connect those wires to the power source running through the fuse box.



- If the power is not turned ON (or it is ON, but will be OFF immediately), the speaker wire may have a short-circuit or touched the chassis of the vehicle and the protection function may have been activated. Therefore, the speaker wire should be checked.
- If your car's ignition does not have an ACC position, connect the ignition wires to a power source that can be turned on and off with the ignition key. If you connect the ignition wire to a power source with a constant voltage supply, as with battery wires, the battery may die.
- If the console has a lid, make sure to install the unit so that the faceplate will not hit the lid when closing and opening.
- If the fuse blows, first make sure the wires aren't touching to cause a short circuit, then replace the old fuse with one with the same rating.
- Insulate unconnected wires with vinyl tape or other similar material. To prevent a short circuit, do not remove the caps on the ends of the unconnected wires or the terminals.
- Connect the speaker wires correctly to the terminals to which they correspond. The unit may be damaged or fail to work if you share the \ominus wires or ground them to any metal part in the car.
- When only two speakers are being connected to the system, connect the connectors either to both the front output terminals or to both the rear output terminals (do not mix front and rear). For example, if you connect the \oplus connector of the left speaker to a front output terminal, do not connect the \ominus connector to a rear output terminal.
- After the unit is installed, check whether the brake lamps, blinkers, wipers, etc. on the car are working properly.
- Mount the unit so that the mounting angle is 30° or less.

Connecting Wires to Terminals

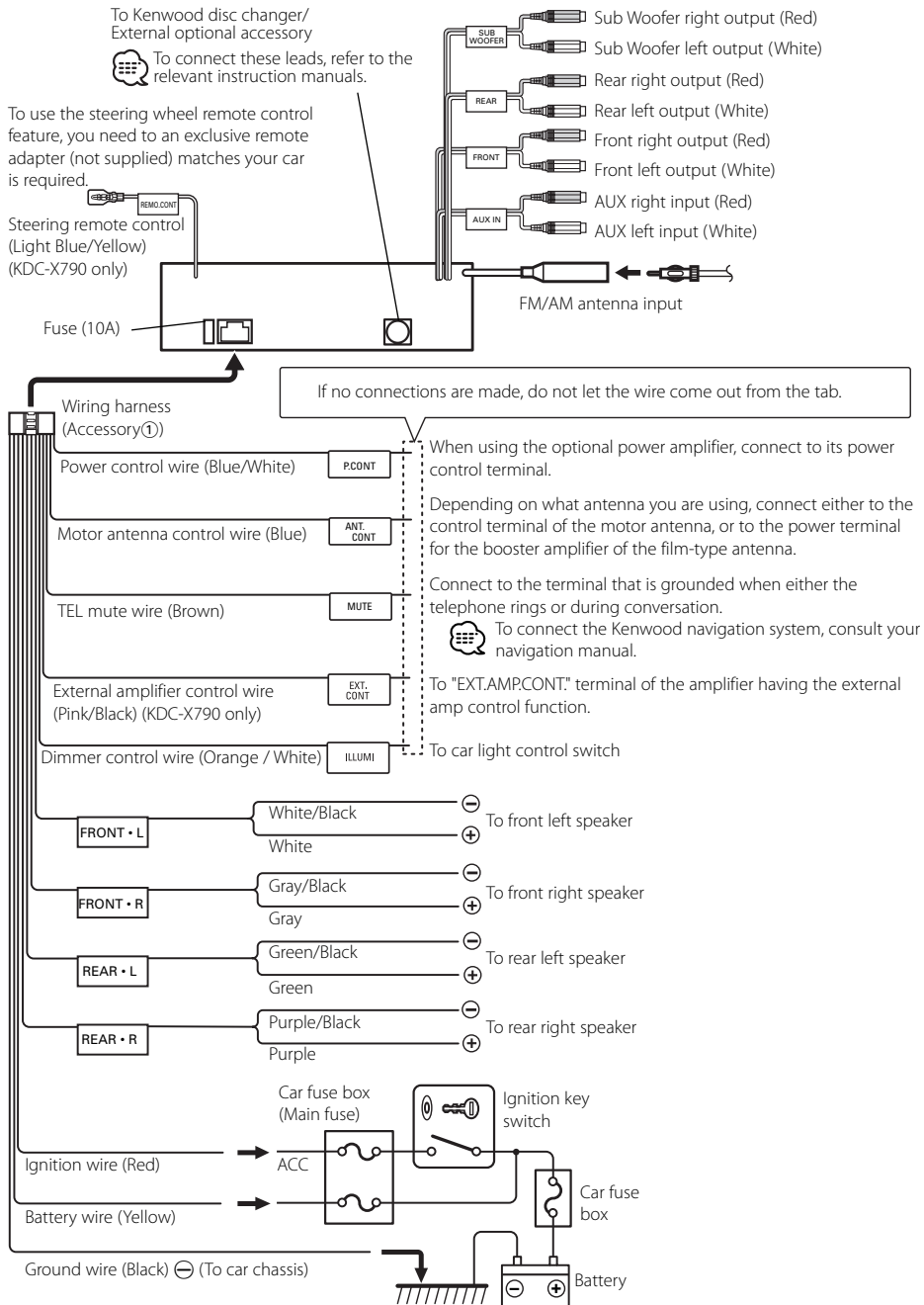

Installation

non-Japanese cars

Metal mounting strap
(commercially available)

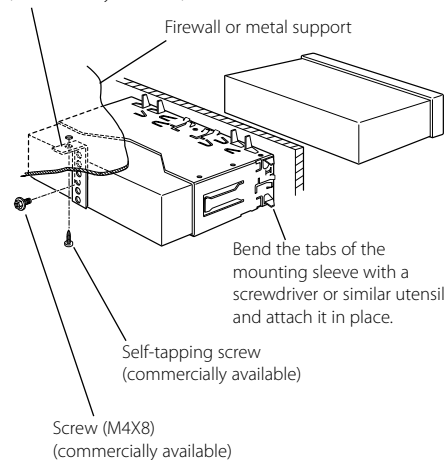

- Make sure that the unit is installed securely in place. If the unit is unstable, it may malfunction (for example, the sound may skip).

Japanese cars

- 1 Refer to the section <Removing the hard rubber frame> (page 59) and then remove the hard rubber frame.
- 2 Align the holes in the unit (two locations on each side) with the vehicle mounting bracket and secure the unit with the accessory screws.

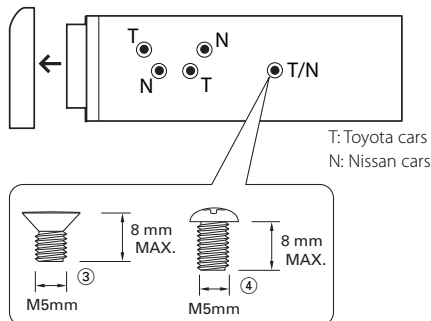

Accessory③...for Nissan car

Accessory④...for Toyota car



- During installation, do not use any screws except for those provided. The use of different screws might result in damage to the main unit.
- Damage may occur if a screwdriver or similar tool is used with excessive force during the installations.

Installation

Screwing the Faceplate on the Unit

If you want to fasten the faceplate to the main unit so that it does not fall off, screw in the provided screws in the holes shown below.

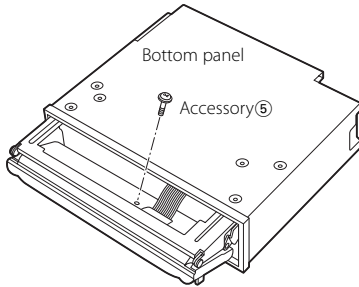

- Never insert the screw in any other screw hole than the one specified. If you screw them in another hole, it will contact and may cause damage to the mechanical parts inside the unit.

Removing the Unit

Removing the hard rubber frame

- 1 Engage the catch pins on the removal tool and remove the two locks on the upper level. Upper the frame and pull it forward as shown in the figure.

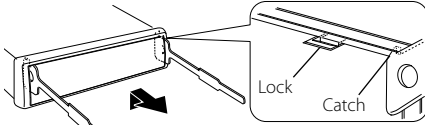

Accessory②
Removal tool

- 2 When the upper level is removed, remove the lower two locations.

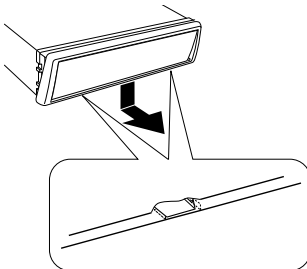

- The frame can be removed from the bottom side in the same manner.

Removing the Unit

- 1 Refer to the section <Removing the hard rubber frame> (page 59) and then remove the hard rubber frame.
- 2 Remove the screw (M4 × 8) on the back panel.
- 3 Insert the two removal tools deeply into the slots on each side, as shown.

Screw (M4X8)
(commercially available)

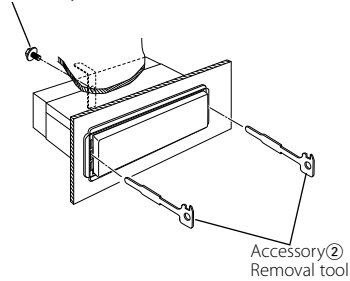

Accessory②
Removal tool

- 4 Lower the removal tool toward the bottom, and pull out the unit halfway while pressing towards the inside.

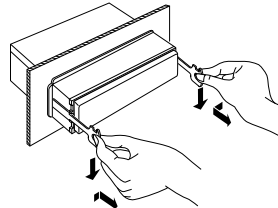

- Be careful to avoid injury from the catch pins on the removal tool.

- 5 Pull the unit all the way out with your hands, being careful not to drop it.

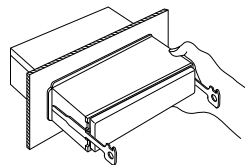

Troubleshooting Guide

What might seem to be a malfunction in your unit may just be the result of slight misoperation or miswiring. Before calling service, first check the following table for possible problems.

General

? The power does not turn ON.

- ✓ The fuse has blown.
 - ☞ Set the media you want for short circuits in the wires, replace the fuse with one with the same rating.

? There's a source you can't switch.

- ✓ There's no media inserted.
 - ☞ Set the media you want to listen to. If there's no media in this unit, you can't switch to each source.
- ✓ The Disc changer isn't connected.
 - ☞ Connect the Disc changer. If the Disc changer isn't connected to its input terminal, You can't switch to an external disc source.

? The memory is erased when the ignition is turned OFF.

- ✓ The ignition and battery wire are incorrectly connected.
 - ☞ Connect the wire correctly, referring to the section on <Connecting Wires to Terminals>.

? There's no loudness effect.

- ✓ You're using Subwoofer preout.
 - ☞ Loudness has no effect in Subwoofer preout.

? The TEL mute function does not work.

- ✓ The TEL mute wire is not connected properly.
 - ☞ Connect the wire correctly, referring to the section on <Connecting Wires to Terminals>.

? The TEL mute function turns ON even though the TEL mute wire is not connected.

- ✓ The TEL mute wire is touching a metal part of the car.
 - ☞ Pull the TEL mute wire away from the metal part of the car.

? Even if Loudness is turned ON, high-pitched tone isn't compensated for.

- ✓ Tuner source is selected.
 - ☞ High-pitched tone isn't compensated for when in Tuner source.

? No sound can be heard, or the volume is low.

- ✓ The fader or balance settings are set all the way to one side.
 - ☞ Center the fader and balance settings.
- ✓ The input/output wires or wiring harness are connected incorrectly.
 - ☞ Reconnect the input/output wires or the wiring harness correctly. See the section on <Connecting Wires to Terminals>.
- ✓ The values of Volume offset are low.
 - ☞ Turn up the Volume offset, referring to the section on <Audio Setup> (page 12).
- ✓ The <Built-in Amp Setting> (page 41) is OFF.
 - ☞ Turn it ON.

? The sound quality is poor or distorted.

- ✓ One of the speaker wires is being pinched by a screw in the car.
 - ☞ Check the speaker wiring.
- ✓ The speakers are not wired correctly.
 - ☞ Reconnect the speaker wires so that each output terminal is connected to a different speaker.

? The Touch Sensor Tone doesn't sound.

- ✓ The preout jack is being used.
 - ☞ The Touch Sensor Tone can't be output from the preout jack.

? Even though Synchronize Clock is ON, the clock can't be adjusted.

- ✓ The received RDS station isn't sending time data.
 - ☞ Receive another RDS station.

? The Dimmer function does not work.

- ✓ The Dimmer wire is not connected correctly.
 - ☞ Check the Dimmer wire connection.
- ✓ The <Dimmer> (page 41) is OFF.
 - ☞ Turn it ON.

? The sound is not output from Subwoofer or it outputs the different sound.

- ✓ When "2 ZONE" of <Audio Setup> (page 12) is set to ON.
 - ☞ Turn OFF "2 ZONE" of <Audio Setup>.

? The display blacks out while scrolling.

- ✓ <Display Illumination Control> is set to OFF.
 - ☞ Refer to <Display Illumination Control> (page 41).

Tuner source

? Radio reception is poor.

- ✓ The car antenna is not extended.
E38 Pull the antenna out all the way.
- ✓ The antenna control wire is not connected.
E38 Connect the wire correctly, referring to the section on <Connecting Wires to Terminals>.

? The desired frequency can't be entered with the Direct Access Tuning.

- ✓ A station that can't be received is being entered.
E38 Enter a station that can be received.
- ✓ You're trying to enter a frequency with a 0.01 MHz unit.
E38 What can be designated in the FM band is to 0.1 MHz.

? It isn't the set Traffic information sound volume.

- ✓ The set sound volume is less than the tuner sound volume.
E38 If the tuner sound volume is louder than the set sound volume, the tuner sound volume is used.

Disc source

? "AUX EXT" is displayed without achieving External disc control mode.

- ✓ Unsupported disc changer is connected.
E38 Use the disc changer mentioned in the <About CD players/disc changers connected to this unit> (page 4) of the section on <Safety precautions>.

? The specified disc does not play, but another one plays instead.

- ✓ The specified CD is quite dirty.
E38 Clean the CD.
- ✓ The disc is loaded in a different slot from that specified.
E38 Eject the disc magazine and check the number for the specified disc.
- ✓ The disc is severely scratched.
E38 Try another disc instead.

? A CD ejects as soon as it is loaded.

- ✓ The CD is quite dirty.
E38 Clean the CD, referring to the CD cleaning of the section on <About CDs> (page 7).

? Can't remove disc.

- ✓ The cause is that more than 10 minutes has elapsed since the vehicle ACC switch was turned OFF.
E38 The disc can only be removed within 10 minutes of the ACC switch being turned OFF. If more than 10 minutes has elapsed, turn the ACC switch ON again and press the Eject button.

? The disc won't insert.

- ✓ There's already another disc inserted.
E38 Press the [▲] button and remove the disc.

? Direct Search can't be done.

- ✓ Another function is ON.
E38 Turn Random Play or other functions OFF.

? Track Search can't be done.

- ✓ For the discs/folders first or last song.
E38 For each disc/folder, Track Search can't be done in the backward direction for the first song or in the forward direction for the last song.

Troubleshooting Guide

Audio file source

? Cannot play an Audio file.

- ✓ The media is scratched or dirty.
ESB Clean the media, referring to the CD cleaning of the section on <About CDs> (page 7).

? The sound skips when an Audio file is being played.

- ✓ The media is scratched or dirty.
ESB Clean the media, referring to the CD cleaning of the section on <About CDs> (page 7).
- ✓ The recording condition is bad.
ESB Record the media again or use another media.

? The Audio file track time isn't displayed correctly.

- ✓ ---
ESB There are times when it isn't displayed correctly according to the Audio file recording conditions.

? Supreme does not take effect when it is turned ON.

- ✓ Little high-frequency component.
ESB Supreme would not take effect with songs with little high-frequency component.
- ✓ Songs that have not been encoded at bit rates at 96 kbps or less (fs = 32k, 44.1 k, 48 kHz) or those that have been encoded at a variable bit rate cannot be decoded to reproduce their high-frequency components.
ESB ---

HD Radio source

? No sound can be heard, or the volume is low.

- ✓ The preset broadcast station is not transmitting in the mode that was set with <Receive mode Setting> (page 47).
ESB Please set <Receive mode Setting> to "Auto".
- ✓ In digital AM broadcasting, receive mode switches between stereo and monaural too often.
ESB Receiving condition is bad or unstable. Stereo is chosen when receiving condition is good, and it switches to monaural when the condition becomes bad.
- ✓ HD Radio tuner is connected to KCA-S210A or other units.
ESB Connect the HD Radio tuner directly to this unit.

The messages shown below display your systems condition.

- Eject: No disc magazine has been loaded in the changer. The disc magazine is not completely loaded.
✦ Load the disc magazine properly. No CD in the unit.
✦ Insert the CD.
- No Disc: No disc has been loaded in the disc magazine.
✦ Load a disc into the disc magazine.
- TOC Error: No disc has been loaded in the disc magazine.
✦ Load a disc into the disc magazine. The CD is quite dirty. The CD is upside-down. The CD is scratched a lot.
✦ Clean the CD and load it correctly.
- Error 05: The CD is upside-down.
✦ Load the CD correctly.
- Blank Disc: Nothing has been recorded on the MD.
- No Track: No tracks are recorded on the MD, although it has a title.
- Error 15: Media was played that doesn't have data recorded that the unit can play.
✦ Use media that has data recorded that the unit can play.
- No Music Data: Media was played that doesn't have data recorded that the unit can play.
✦ Use media that has data recorded that the unit can play. Files for picture downloading only are recorded in CD-R/CD-RW.
- No Panel: The faceplate of the slave unit being connected to this unit has been removed.
✦ Replace it.
- Error 77: The unit is malfunctioning for some reason.
✦ Press the reset button on the unit. If the "Error 77" code does not disappear, consult your nearest service center.
- Mecha Error: Something is wrong with the disc magazine. Or the unit is malfunctioning for some reason.
✦ Check the disc magazine. And then press the reset button on the unit. If the "Mecha Error" code does not disappear, consult your nearest service center.

Hold Error: The protective circuit in the unit activates when the temperature inside the automatic disc changer exceeds 60°C (140°F), stopping all operation.
 ↳ Cool down the unit by opening the windows or turning on the air conditioner. As the temperature falls below 60°C (140°F), the disc will start playing again.

No Name: Attempted to display DNPS during the CD play having no disc names preset.

Waiting:

- Radio text data is being received.
- Text for the SIRIUS tuner source is being received.

Load: Discs are being exchanged in the Disc changer.

Reading: The unit is reading the data on the disc.

IN (Blink): The CD player section is not operating properly.
 ↳ Reinsert the CD. If the CD cannot be ejected or the display continues to flash even when the CD has been properly reinserted, please switch off the power and consult your nearest service center.

Protect (Blink): The speaker wire has a short-circuit or touches the chassis of the vehicle, and then the protection function is activated.
 ↳ Wire or insulate the speaker cable properly and press the reset button.

Unsupported File:
 An Audio file is played with a format that this unit can't support.
 ↳ ----

Copy Protection:
 A copy-protected file is played.
 ↳ ----

Can't Download:
Download Error:
 This unit does not work properly for some reason.
 ↳ Press the reset button to download it again. If this error is still displayed, consult a local Kenwood dealer.

No Display File:
 No file that can be downloaded is contained in the CD-ROM.
 ↳ Make sure that a files created with referring to <<http://www.kenwood.net-disp.com>> is contained in the CD-ROM. Do not delete the extension (.kbn) created when the file was created.

Incorrect File: The file selected to be downloaded has a format that this unit cannot read.
 ↳ Recreate the file.

Writing Error: Writing failed while the file was downloaded.
 ↳ Try the downloading again.

DEMO MODE (Blink):
 The Demonstration mode has been selected.
 ↳ The <Demonstration mode Setting> (page 51) is ON. Turn it OFF.

Specifications

Specifications subject to change without notice.

FM tuner section

Frequency range (200 kHz space)
: 87.9 MHz – 107.9 MHz
Usable sensitivity (S/N = 30dB)
: 9.3dBf (0.8 μ V /75 Ω)
Quieting Sensitivity (S/N = 50dB)
: 15.2dBf (1.6 μ V /75 Ω)
Frequency response (\pm 3.0 dB)
: 30 Hz – 15 kHz
Signal to Noise ratio (MONO)
: 70 dB
Selectivity (\pm 400 kHz)
: \geq 80 dB
Stereo separation (1 kHz)
: 40 dB

AM tuner section

Frequency range (10 kHz space)
: 530 kHz – 1700 kHz
Usable sensitivity (S/N = 20dB)
: 28 dB μ (25 μ V)

CD player section

Laser diode
: GaAlAs
Digital filter (D/A)
: 8 Times Over Sampling
D/A Converter
: 1 Bit
Spindle speed (Audio file)
: 1000 – 400 rpm (CLV 2times)
Wow & Flutter
: Below Measurable Limit
Frequency response (\pm 1 dB)
: 10 Hz – 20 kHz
Total harmonic distortion (1 kHz)
KDC-X790: 0.008 %
KDC-MP732: 0.01 %
Signal to Noise ratio (1 kHz)
KDC-X790: 110 dB
KDC-MP732: 105 dB
Dynamic range
: 93 dB
MP3 decode
: Compliant with MPEG-1/2 Audio Layer-3
WMA decode
: Compliant with Windows Media Audio
AAC decode
: AAC-LC ".m4a" files

Audio section

Maximum output power
: 50 W x 4
Full Bandwidth Power (at less than 1% THD)
: 22 W x 4
Speaker impedance
: 4 – 8 Ω
Tone action
Bass : 100 Hz \pm 8 dB
Middle : 1 kHz \pm 8 dB
Treble : 10 kHz \pm 8 dB
Preout level / Load (during disc play)
KDC-X790: 5000 mV/10 k Ω
KDC-MP732: 4000 mV/10 k Ω
Preout impedance
: \leq 80 Ω

Auxiliary input

Frequency response (\pm 1 dB)
: 20 Hz – 20 kHz
Input Maximum Voltage
: 1200 mV
Input Impedance
: 100 k Ω

General

Operating voltage (11 – 16V allowable)
: 14.4 V
Current consumption
: 10 A
Installation Size (W x H x D)
: 182 x 53 x 155 mm
7-3/16 x 2-1/16 x 6-1/8 inch
Weight
: 3.31 lbs (1.50 kg)