

KENWOOD

CD-RECEIVER

KDC-MP6539U
KDC-MP6039

INSTRUCTION MANUAL

Kenwood Corporation



Contents

Before use	3	Basic Operations of remote control	19
Basic Operation	4	Appendix	20
General functions		Accessories/ Installation Procedure	22
Tuner functions		Connecting Wires to Terminals	23
Disc & Audio file play functions		Installation/Removing the Unit	24
Function Control	6	Troubleshooting Guide	25
 Read through this page first for the setting of each function.		Specifications	27
Display Settings	8		
About Display Type			
Text Display Selection			
Key Color Selection			
Station/Disc Naming (SNPS/DNPS)			
Auxiliary Input Display Setting			
Music disc/Audio file Operation	11		
Music Select			
Direct Music Search			
Direct Disc Search			
Basic Operation of Disc Changer (Optional)			
Tuner Operation	12		
Station Preset Memory			
Preset Tuning			
Direct Access Tuning			
Frequency Step Setting			
Other Functions	13		
Security Code			
Manual Clock Adjustment			
Date Adjustment			
Demonstration mode setting			
Audio Adjustments	15		
Audio Control			
Audio Setup			
Speaker Setting			
Audio Preset Memory			
Audio Preset Recall			
TV control (Optional)	18		
Basic Operation			
Preset Memory			
Preset Tuning			
Direct TV Tuning			

中文字型由北京字研技术开发中心提供

- iPod is a trademark of Apple, Inc., registered in the U.S. and other countries.
- The "AAC" logo is trademark of Dolby Laboratories.

Before use

▲WARNING

To prevent injury or fire, take the following precautions:

- To prevent a short circuit, never put or leave any metallic objects (such as coins or metal tools) inside the unit.

Before using this unit for the first time

This unit is initially set on the Demonstration mode. When using this unit for the first time, cancel the <Demonstration mode Setting> (page 14).

How to reset your unit

- If this unit or the connected unit (disc auto changer, etc.) fails to operate properly, press the Reset button. The unit returns to factory settings when the Reset button is pressed.

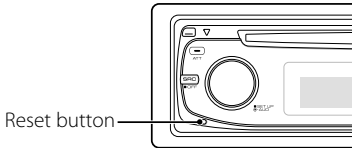

Cleaning the Unit

If the faceplate of this unit is stained, wipe it with a dry soft cloth such as a silicon cloth. If the faceplate is stained badly, wipe the stain off with a cloth moistened with neutral cleaner, then wipe it again with a clean soft dry cloth.



- Applying spray cleaner directly to the unit may affect its mechanical parts. Wiping the faceplate with a hard cloth or using a volatile liquid such as thinner or alcohol may scratch the surface or erase characters.

Cleaning the Faceplate Terminals

If the terminals on the unit or faceplate get dirty, wipe them with a clean soft dry cloth.

Lens Fogging

When you turn on the car heater in cold weather, dew or condensation may form on the lens in the CD player of the unit. Called lens fogging, this condensation on the lens may not allow CDs to play. In such a situation, remove the disc and wait for the condensation to evaporate. If the unit still does not operate normally after a while, consult your Kenwood dealer.

- If you experience problems during installation, consult your Kenwood dealer.
- When you purchase optional accessories, check with your Kenwood dealer to make sure that they work with your model and in your area.
- Characters that conform to ISO 8859-1 can be displayed.
- Characters that conform to GB2312 or ISO 8859-1 can be displayed. Refer to "MENU" > "Chinese" of <Function Control> (page 6).
- In this document, the description indicator will light means a status is displayed. Refer to <About Display Type> (page 8) for the details of the status display.
- The illustrations of the display, the function icon and the panel appearing in this manual are examples used to explain more clearly how the controls are used. Therefore, what appears on the display in the illustrations may differ from what appears on the display on the actual equipment, and some of the illustrations on the display may be inapplicable.

Handling CDs



- Do not touch the recording surface of the CD.
- Do not stick tape etc. on the CD, or use a CD with tape stuck on it.
- Do not use disc type accessories.
- Clean from the center of the disc and move outward.
- When removing CDs from this unit, pull them out horizontally.
- If the CD center hole or outside rim has burrs, use the CD only after removing the burrs with a ballpoint pen etc.

CDs that cannot be used

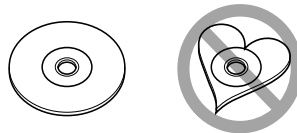
- CDs that are not round cannot be used.



- CDs with coloring on the recording surface or CDs that are dirty cannot be used.

- This unit can only play the CDs with   

This unit may not correctly play discs which do not have the mark.

- You cannot play a CD-R or CD-RW that has not been finalized. (For the finalization process refer to your CD-R/CD-RW writing software, and your CD-R/CD-RW recorder instruction manual.)

Basic Operation

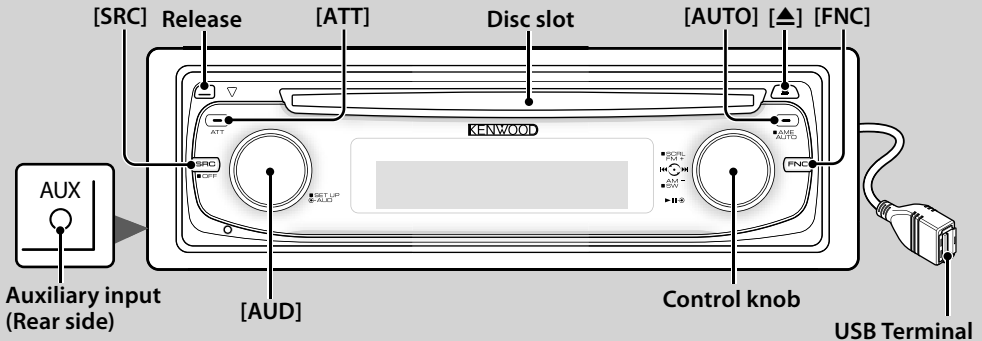

General functions

Power/Source Select button [SRC]

Turns on the power.

When the power is ON, select a source.

SRC Select mode 1: Press the [SRC] button and then turn the Control knob or push it toward left or right. To determine the selected source, press the Control knob.

SRC Select mode 2: Pressing this button each time switches between sources.

Tuner ("TUNER"), USB*1 or iPod*1 ("USB" or "iPod"), CD ("Compact Disc"), Auxiliary input ("AUX"), and Standby ("STANDBY")

Press at least 1 second to turn off the power.



- When the power is ON, the <Security Code> (page 12) is displayed as "CODE ON" or "CODE OFF".
- The SRC Select mode can be set in "MENU" > "SRC Select" of <Function Control> (page 6).
- When an optional accessory is connected, the source name for each device appears.
- When connection of the iPod is recognized, the source display changes from "USB" to "iPod". *1
- USB*1 (iPod) source is recognized as CD source on the connected unit.

*1 Function of KDC-MP6539U.

Volume control [AUD]

Turn the knob to adjust the volume.

Attenuator [ATT]

Turning the volume down quickly.

When the volume is reduced, the "ATT" indicator flashes.

Muting volume upon reception of phone call

When there is a call, "CALL" is displayed and the audio system is paused.

When the call ends, "CALL" disappears and the audio system comes back on.

The audio system comes back on when [SRC] is pressed during a call.



- To use the TEL Mute feature, you need to hook up the MUTE wire to your telephone using a commercial telephone accessory. Refer to <Connecting Wires to Terminals> (page 23).

Faceplate release Release

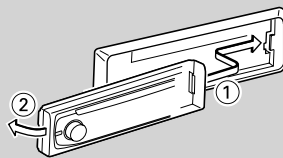

Releases the faceplate lock so that it can be removed. Refer to the following diagram when reattaching the faceplate.



- The faceplate is a precision piece of equipment and can be damaged by shocks or jolts.
- Keep the faceplate in its faceplate case while detached.
- Do not place the faceplate (and the faceplate case) in areas exposed to direct sunlight, excessive heat or humidity. Also avoid places with too much dust or the possibility of water splashing.
- To prevent deterioration, do not touch the terminals of the unit or faceplate with your fingers.

Auxiliary input Auxiliary input

Connect a portable audio device with mini-plug cable (3.5 ϕ).

  : Indicates the button etc. to operate.



- Use the mini-plug cable which is stereo type and does not have any resistance.
- The auxiliary input requires the setting made in "MENU" > "Built in AUX" of <Function Control> (page 6).

Subwoofer output **Control knob**

Switches between ON ("SUBWOOFER ON") and OFF ("SUBWOOFER OFF") each time pushing toward down for at least 2 seconds.

Function Control **[FNC]**

Pressing this button allows you to set various functions using the Control knob. Refer to <Function Control> (page 6).

Category	Function of setup item
MENU	Allows you to set up the environment.
DISP	Allows you to set up the display.

Text/Title scroll **Control knob**

Scrolls the CD and audio file text display when pushing toward up for at least 2 seconds.

Tuner functions

Band select **Control knob**

Switches between FM1, FM2, and FM3 each time pushing toward up.
Switches to AM when pushing toward down.

Tuning **Control knob**

Changes the frequency when pushing toward left or right.



- During reception of stereo stations the "ST" indicator is ON.

Tuning mode select **[AUTO]**

Switches as follows each time this button is pressed.

Tuning mode	Display	Operation
Auto seek	"Auto1"	Automatic search for a station.
Preset station seek	"Auto2"	Search in order of the stations in the Preset memory. (page 12)
Manual	"Manual"	Normal manual tuning control.

Auto memory entry **[AUTO]**

Memorizes six stations with good reception automatically when pressed for at least 2 seconds.

Disc & Audio file play functions

Disc play **Disc slot**

Starts playing when a disc is inserted.
When a CD is inserted, the "IN" indicator is ON.



- 3 inch (8 cm) CD cannot be used. Attempt to insert using an adapter can cause malfunction.

Disc ejection **[▲]**



- You can eject the disc for 10 minutes after switching off the engine.

USB device/iPod play (Function of KDC-MP6539U)

USB Terminal

Connecting a USB device starts playback.



- For the playable audio file, media, and devices, refer to <About Audio file> (page 20).

Pause and play **Control knob**

Switches between pause and play each time the center is pressed.

USB device removing (Function of KDC-MP6539U)



Press this button for 2 seconds or longer to select the remove mode, and the remove the USB device.
During the remove mode, the "USB REMOVE" indicator is ON.

Music search **Control knob**

Changes the music when pushing toward left or right.
Fast reverses or forwards the music while keeping pushing toward left or right. (No sound is output while playing audio file.)

Folder search **Control knob**

Changes the folder containing the audio file when pushing toward up or down.

Function Control

Functions in the table below can be set up by using Function Control.

Category	Item	Setting	Entry	Setting overview	Condition	Page
MENU	"Security Set"		1 sec.	Sets security code	SB	13
	"SRC Select"	"1"/"/2"		Sets the source selection method.	SB	21
	"iPod Mode" ^{*1}	"OFF"/"ON" ^{**}		When set to "ON", allows you to select music in the manner similar to that of the iPod.	iPod	11
	"AT COL CHG" ^{*1}	"OFF"/"iPod" ^{**}		When the iPod source is used, sets whether the illumination color is changed by the iPod.	iPod	21
	"Beep"	"OFF"/"ON" ^{**}		Setting the operation check sound (beep sound) ON/OFF.	SB	
	"Clock Adjust"		1 sec.	Sets the clock.	SB	14
	"Date Adjust"		1 sec.	Sets the date.	SB	14
	"Date Mode"	7 types	1 sec.	Sets the date display mode.	SB	
	"Display"	"OFF"/"ON" ^{**}		Turns off the display when no operation is performed.	—	21
	"Dimmer"	"OFF"/"ON" ^{**}		Dims the display part in conjunction with the light switch of the vehicle.	SB	
	"ILM Dimmer"	"AUTO"/"/MNAL1"/ "MNAL2"/"/OFF"		Sets whether the key illumination is dimmed in conjunction with the light switch of the vehicle or it is dimmed constantly.	SB	21
	"ILM Effect"	"OFF"/"ON" ^{**}		Sets whether the key illumination color ^{*1} /brightness ^{*2} is changed in conjunction with the key operation. (^{*1} To connect the Bluetooth unit)	SB	
	"ILM MSC SYNC"	"OFF"/"/ON"		Sets whether the key illumination color ^{*1} /brightness ^{*2} is changed in conjunction with the sound volume.	—	
	"AMP"	"OFF"/"ON" ^{**}		Turns on/off the built-in amplifier.	SB	21
	"Zone2"	"Rear"/"/Front"		Specifies the destination of AUX input sound when the Dual Zone function is turned on.	2ZONE	21
	"Supreme"	"OFF"/"ON" ^{**}		Turns ON/OFF the Supreme function.	AF2	21
	"CRSC"	"OFF"/"ON" ^{**}		Switches to Monaural to decrease noise when reception is poor.	FM	
	"Name Set"		1 sec.	Sets the station name (SNPS)/ disc name (DNPS)/ AUX name.	→	10
	"Chinese" ^{*1}	"OFF"/"/ON"		Selects Chinese as the display language.	SB	21
	"Scroll"	"Auto"/"/Manual"		Specifies whether the text is scrolled automatically.	—	
	"Built in AUX"	"OFF"/"/ON"		Sets whether to display AUX during source selection.	SB	
	"CD Read"	"1"/"/2"		Sets the CD read mode.	SB	21
	"Audio Preset"		1 sec.	Presets the setting value of the audio control. The preset value is retained after resetting.	SB	16, 17
	"DEMO Mode"	"OFF"/"ON" ^{**}	2 sec.	Specifies whether to enable demonstration.	—	14
DISP	> TYPE	A/ B/ C/ D/ E/ F/ G		Sets the display pattern.	—	8
	> GRAPH	Spectrum Analyzer 1 → 2		Sets the Type E spectrum analyzer display.	E	
	> SIDE	Text icon/ Source icon		Sets the Type A side icon display.	A	
	> TEXT			Sets the text display.	A B C D F	8
K-COL ^{*1}				Sets the button illumination color.	Illumi	9
PMEM				Presets a station.	→	12, 18
SCAN		"ON"/ —		When set to "ON", plays the intro of the music in the folder successively.	AF2	
RDM		"ON"/ —		When set to "ON", plays the music in the folder randomly.	AF1	
FIREP		"ON"/ —		When set to "ON", plays the music repeatedly.	AF1	
FoREP		"ON"/ —		When set to "ON", plays the music in the folder repeatedly.	AF2	
SCAN		"ON"/ —		When set to "ON", plays the intro of the music on the disc successively.	DISC	
RDM		"ON"/ —		When set to "ON", plays the music on the disc randomly.	DISC	

Category	Item	Setting	Entry	Setting overview	Condition	Page
M.RDM		"ON"/ —		When set to "ON", plays the music in the disc changer randomly.	CH	
T.REP		"ON"/ —		When set to "ON", plays the music repeatedly.	DISC	
D.REP		"ON"/ —		When set to "ON", plays the music on the disc repeatedly.	CH	

*Factory setting

*1 Function of KDC-MP6539U.

*2 Function of KDC-MP6039.

Displayed item is depending on currently selected source or mode. The mark in Condition column shows the condition to which the item is displayed.

SB : Can be set in other than standby state.

SB : Can be set in standby state.

AF1 : Can be set while Audio file source of CD/USB/iPod.

AF2 : Can be set while Audio file source of CD/USB (excluding iPod).

DISC : Can be set while CD/ Disc changer source.

CH : Can be set while Disc changer source.

Tuner : Can be set during Tuner source.

FM : Can be set during FM reception.

AUX : Can be set while accessing AUX source.

iPod : Can be set only during playback of the iPod source. (USB source used when the iPod is connected)

2ZONE : Can be set for sources other than the standby source by setting "2 ZONE" of <Audio Setup> (page 15) to "ON".

illumi : Sets "ILM MSC SYNC" and "AT COL CHG" in the menu to "OFF".

→ : Refer to the reference page.

A-F : Can be set when the specified type is selected for Display Type.

— : Can be set during all sources.



- Refer to the respective page for information on how to set the items with reference page number.
- Only the items available to the current source are displayed.
- Strong electrical fields (such as from power lines) may cause unstable sound quality when CRSC is turned ON. In such a situation, turn it OFF.
- "ILM MSC SYNC" is displayed when "MENU" > "AT COL CHG" in <Function Control> is set to "OFF".

1 Enter Function Control mode

Press the [FNC] button.

Function icon is displayed.

2 Select your desired setup item

Operation type	Operation
Movement between items	Turn the Control knob.
Selection of item	Press the Control knob.
Return to previous item	Press the [FNC] button or " " icon

Repeat selection and determination until your desired setup item is selected.

Example:

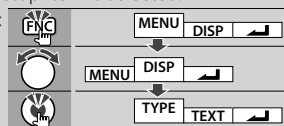

3 Make a setting

Turn the Control knob to select a setting value, and then press the Control knob.

Some items require you to keep pressing the Control knob for 1 or 2 seconds so that you can make a setting. For these items, the time during which you need to keep pressing the Control knob is displayed in the Entry column in seconds. For the functions accompanied by the description of the setting procedure and so forth, the reference page numbers are displayed.







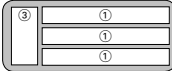

4 Exit Function Control mode

Press the [FNC] button for at least 1 second.

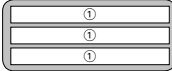
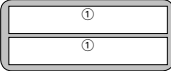
Display Settings

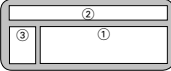
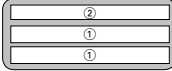
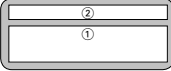
About Display Type

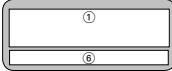
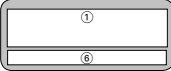
Shown below are examples of display types.

Display	Display Type	Chinese display
"TYPE [A]"		
"TYPE [B]"		
"TYPE [C]"		
"TYPE [D]"		
"TYPE [E]"		
"TYPE [F]"		
"TYPE [G]"		

- To select the Chinese display type, select "ON" in "MENU" > "Chinese" of <Function Control> (page 6).



- ① Text display part
- ② Status display
- ③ Icon display part
- ④ Spectrum Analyzer display
- ⑤ Clock display
- ⑥ Display (varied depending on the source)

Text Display Selection

Changing the text display.

In Tuner source

Information	Display
Station name	"SNPS"
Frequency	"Frequency"
Spectrum Analyzer & Clock	"Speana/Clock"
Clock	"Clock"
Date	"Date"
Blank	"Blank"

In CD & External disc source

Information	Display
Disc title	"Disc Title"
Track title	"Track Title"
Play time & Track number	"P-Time"
Disc name	"DNPS"
Spectrum Analyzer & Clock	"Speana/Clock"
Clock	"Clock"
Date	"Date"
Blank	"Blank"

In Audio file source

Information	Display
Music title & Artist name	"Title/Artist"
Album name & Artist name	"Album/Artist"
Folder name	"Folder Name"
File name	"File Name"
Play time & Music number	"P-Time"
Spectrum Analyzer & Clock	"Speana/Clock"
Clock	"Clock"
Date	"Date"
Blank	"Blank"

In Standby

Information	Display
Standby	"Source Name"
Clock	"Clock"
Date	"Date"
Blank	"Blank"

In Auxiliary input source

Information	Display
Auxiliary input name	"Source Name"
Spectrum Analyzer & Clock	"Speana/Clock"
Clock	"Clock"
Date	"Date"
Blank	"Blank"

1 Enter Text Display Selection mode (In Display Type A/ B/ C/ D/ F)

Select "DISP" > "TEXT".

For how to select Function Control item, refer to <Function Control> (page 6).

2 Select the text display part (Display Type A/ B/ C/ D only)

Push the Control knob towards up or down.

The selected text display part blinks.

3 Select the text

Turn the Control knob or push it towards left or right.

4 Exit Text Display Selection mode

Press the Control knob.



- If the selected display item does not have any information, alternative information is displayed.
- Some items cannot be selected depending on the display type and row.
- When selecting "Folder Name" while playing with iPod, names will be displayed depending on currently selected browsing items.

Function of KDC-MP6539U

Key Color Selection

Selecting the Key (Button) color.

1 Enter Key Color Selection mode

Select "K-COL".

For how to select Function Control item, refer to <Function Control> (page 6).

2 Select the Key Color

Basic color

Turn the Control knob or push it towards left or right.

"Variable Scan"/"Color1" — "Color10"/"User"

Detail color (RGB-based adjustment)

Operation type	Operation
To select the detail color adjustment mode.	Press the Control knob for at least 1 second.
To select the color to adjust. (red, green, or blue)	Push the Control knob towards right or left.
To adjust color. (Range: 0 – 9)	Turn the Control knob or push it towards up or down.
To exit the detail color adjustment mode.	Press the Control knob.

3 Exit Key Color Selection mode

Press the [FNC] button.



- When colors are adjusted in the detail color mode, the values set with "User" selected in the basic color mode are used.
- In the basic color mode, selecting "Variable Scan" scans basic colors. During scanning, you cannot adjust detail colors.

Display Settings

Station/Disc Naming (SNPS/DNPS)

Attaching a title to a Station or CD.

1 Receive/play the station/disc you want to attach a title to

2 Select Name set mode item during Menu mode

Select the "Name Set" display.

For how to select Function Control items, refer to <Function Control> (page 6).

3 Enter Name set mode

Press the Control knob for at least 1 second.

4 Enter the name

Operation type	Operation
Move the cursor to the enter character position	Push the Control knob towards right or left.
Select the character type*	Press the Control knob.
Select the characters	Turn the Control knob or push it towards up or down.

* Each time you press the knob, the character type alternates between the types shown in the table below.

Character type	
Alphabet upper case	
Alphabet lower case	
Numbers and symbols	
Special characters (Accent characters)	



- Enter characters by using a remote control with numbers buttons.

Example: If you are entering "DANCE".

Character	"D"	"A"	"N"	"C"	"E"
Button	[3] [▶▶]	[2] [▶▶]	[6] [▶▶]	[2] [▶▶]	[3]
Times pressed	1	1	2	3	2

5 Exit Menu mode

Press the [FNC] button.



- A title cannot be attached to Audio file media.
- When operation stops for 10 seconds the name at that time is registered, and Name Set mode closes.
- Memory numbers
 - FM/AM: 30 stations
 - Internal CD player: 10 discs
 - External CD changer/ player: Varies according to the CD changer/ player. Refer to the CD changer/ player manual.
- Change the title of station/CD by the same operation used to name it.

Auxiliary Input Display Setting

Selects the display below when changing to Auxiliary input source.

1 Select Auxiliary input display setting item during Menu mode (In AUX mode)

Select the "Name Set" display.

For how to select Function Control items, refer to <Function Control> (page 6).

2 Enter Auxiliary input display setting mode Press the Control knob for at least 1 second.

The presently selected Auxiliary input display is displayed.

3 Select the Auxiliary input display

Turn the Control knob or push it towards up or down.

"AUX"/"DVD"/"PORTABLE"/"GAME"/"VIDEO"/"TV"

4 Exit Auxiliary input display setting mode

Press the [FNC] button.



- When operation stops for 10 seconds, the name at that time is registered, and the Auxiliary input display setting mode closes.
- The Auxiliary input display can be set only when the built-in auxiliary input or the auxiliary input of optional KCA-S220A is used. On the KCA-S220A, "AUX EXT" is displayed by default.

Music disc/Audio file Operation

Function of Audio file/ Internal CD source

Music Select

Selecting the music you want to listen to from the device or media being played now.

1 Enter Music Select mode

Turn the Control knob.

The music list is displayed.

2 Search for music

Select the category item using the Control knob.

iPod source ("iPod Mode : ON") (KDC-MP6539U only)

Operation type	Operation
Movement between items	Turn the Control knob.
Selection of item	Press the Control knob.
Return to previous item	Push the Control knob towards up.
Return to first item	Push the Control knob towards up for at least 1 second.

Other source

Audio file

Operation type	Operation
Movement between items	Turn the Control knob or push it towards up or down.
Selection of item	Push the Control knob towards right.
Return to previous item	Push the Control knob towards left.
Return to first item	Push the Control knob towards left for at least 1 second.

Internal CD source

Operation type	Operation
Movement between track	Turn the Control knob or push it towards up or down.
Selection of track	Press the Control knob.
Return to first track	Push the Control knob towards left for at least 1 second.

The "◀" or "▶" symbol shown beside the displayed item indicates that the item is preceded or followed by another item.

Selecting a music will play it from the beginning.

Cancelling Music Select

Press the [FNC] button.



- Music Select cannot be performed during Random play.
- Set the iPod mode in "MENU" > "iPod Mode" of <Function Control> (page 6).

Function of remote control

Direct Music Search

Searches the music by entering the track number.

1 Enter the music number

Press the number buttons on the remote control.

2 Search the music

Press the [◀◀] or [▶▶] button.

Cancelling Direct Music Search

Press the [▶II] button.



- Direct Music Search cannot be performed during playing of iPod, "Music Editor" media, Random play, or scan play.

Function of disc changers with remote control

Direct Disc Search

Searches the disc by entering the disc number.

1 Enter the disc number

Press the number buttons on the remote control.

2 Search the disc

Press the [FM] or [AM] button.

Cancelling Direct Disc Search

Press the [▶II] button.



- Direct Disc Search cannot be performed during playing of Random play or scan play.

Basic Operation of Disc Changer (Optional)

Selecting CD changer source

Press the [SRC] button.

Select the "CD Changer" display.

For how to select source item, refer to <Power/Source Select button> of <Basic Operation> (page 4).

Music search

Push the Control knob towards right or left.

Disc Search

Push the Control knob towards up or down.

Tuner Operation

Station Preset Memory

Putting a station in the memory.

- 1 Select the frequency to put in the memory**
Push the Control knob towards right or left.
- 2 Enter Preset Memory mode**
Select "P.MEM".
For how to select Function Control item, refer to <Function Control> (page 6).
- 3 Select the number to put in the memory**
Turn the Control knob.
- 4 Determine the number to put in the memory**
Press the Control knob.
- 5 Allow the determined number to take effect**
Press the Control knob.

Canceling the Preset Memory mode

Press the [FNC] button.

Preset Tuning

Recalling the stations in the memory.

- 1 Enter Preset Tuning Select mode**
Turn the Control knob.
A station list is displayed.
- 2 Select a desired station in the memory**
Turn the Control knob.
- 3 Recall the station**
Press the Control knob.

Canceling Preset Tuning

Press the [FNC] button.

Function of remote control

Direct Access Tuning

Entering the frequency and tuning.

- 1 Enter Direct Access Tuning mode**
Press the [DIRECT] button on the remote control.
"----" is displayed.

- 2 Enter the frequency**
Press the number buttons on the remote control.

Example:

Desired frequency	Press button
92.1 MHz (FM)	[0], [9], [2], [1]
810 kHz (AM)	[0], [8], [1], [0]

Canceling Direct Access Tuning

Press the [DIRECT] button on the remote control.



- You can enter the FM band frequency in steps of a minimum of 0.1 MHz.

Frequency Step Setting

Changing the tuning frequency step.

The original setting is FM band 50 kHz, and AM band 9 kHz.

- 1 Turn the power OFF**
Press the [SRC] button for at least 1 second.
- 2 Switch the frequency step**
While pressing the [FNC] and [AUTO] buttons, press the [SRC] button.
Release your fingers from the button after the display appears.
The frequency step changes to FM band 200 kHz, and AM band 10 kHz.



- When the same operation is repeated, the frequency step returns to the original setting.
- When the frequency step is changed, the frequencies in the memory are deleted.

Other Functions

Security Code

When Security Code is set, possibility of theft is reduced because input of Security Code is prompted to turn on the unit once it is turned off.



- When you activate the Security Code function, it cannot be released.
Note, your Security Code is the 4 digit number entered in your "Car Audio Passport" in this package.

1 Select Security Code item during Menu mode (In Standby mode)

"Security Set" is displayed.

For how to select Function Control items, refer to <Function Control> (page 6).

2 Enter Security Code mode

Press the Control knob for at least 1 second.

When "Enter" is displayed, "SECURITY SET" is also displayed.

3 Enter Security Code

Operation type	Operation
Select the digits to enter	Push the Control knob towards right or left.
Select the Security Code numbers	Turn the Control knob or push it towards up or down.

4 Confirm the Security Code

Press the Control knob for at least 3 seconds.

When "Re-Enter" is displayed, "SECURITY SET" is also displayed.

5 Do the step 3 through 4 operation, and reenter the Security Code.

"Approved" is displayed.

The Security Code function activates.



- If you enter a Code different from your Security Code, you have to start over from step 3.

6 Exit Security Code mode

Press the [FNC] button.

Entering Security Code

The Security Code is required to use the audio unit when the unit is first used after removed from the battery power source or the Reset button is pressed.

1 Turn the power ON.

2 Do the step 3 through 4 operation, and reenter the security code.

"Approved" is displayed.

Now, you can use the unit.



- If an incorrect code is entered, "Waiting" is displayed, and the input prohibition periods shown in the table below is generated.
After the input prohibition time lapses, "SECURITY" is displayed, and you can reenter the code.

Number of times the incorrect code was input	Input prohibited time
1	—
2	5 minutes
3	1 hour
4	24 hours

Other Functions

Manual Clock Adjustment

1 Select Clock Adjustment item during Menu mode (In Standby mode)

Select the "Clock Adjust" display.

For how to select Function Control items, refer to <Function Control> (page 6).

2 Enter Clock adjustment mode

Press the Control knob for at least 1 second.

The clock display blinks.

3 Adjusting Clock

Operation type	Operation
Selecting the item (hours or minutes)	Push the Control knob towards right or left.
Adjust each item	Turn the Control knob or push it towards up or down.

4 Exit Clock adjustment mode

Press the [FNC] button.

Date Adjustment

1 Select Date Adjustment item during Menu mode (In Standby mode)

Select the "Date Adjust" display.

For how to select Function Control items, refer to <Function Control> (page 6).

2 Enter Date adjustment mode

Press the Control knob for at least 1 second.

The date display blinks.

3 Adjusting Date

Operation type	Operation
Selecting the item (month, day, or year)	Push the Control knob towards right or left.
Adjust each item	Turn the Control knob or push it towards up or down.

4 Exit Date adjustment mode

Press the [FNC] button.

Demonstration mode setting

Turning the demonstration mode ON/OFF.

1 Select Demonstration item during Menu mode

Select the "DEMO Mode" display.

For how to select Function Control items, refer to <Function Control> (page 6).

2 Set the Demonstration mode

Press the Control knob for at least 2 seconds.

Pressing this button for 2 seconds or longer toggles the setting between "ON" and "OFF".

3 Exit Demonstration mode

Press the [FNC] button.

Audio Adjustments

Audio Control

You can adjust following Audio Control items ;

Adjustment Item	Display	Range
Rear volume	"REAR VOLUME"	0 — 35
Subwoofer level	"SUB-W LEVEL"	-15 — +15
System Q	"NATURAL"/ "USER"/"ROCK"/ "POPS"/"EASY"/ "TOP40"/"JAZZ"	Natural/User setting/Rock/ Pops/Easy/Top 40/Jazz (The indicator turns on according to the setting.)
Bass level*	"BASS LEVEL"	-8 — +8
Middle level*	"MIDDLE LEVEL"	-8 — +8
Treble level*	"TREBLE LEVEL"	-8 — +8
Balance	"BALANCE"	Left 15 — Right 15
Fader	"FADER"	Rear 15 — Front 15

Exit Audio Control mode (Volume control mode)

* Source tone memory: Puts the set up value in the memory per source.



- "USER": The ranges selected lastly for Bass level, Middle level, and Treble level are recalled automatically.

1 Select the source to adjust

For how to select source item, refer to <Power/Source Select button> of <Basic Operation> (page 4).

2 Enter Audio Control mode

Press the [AUD] knob.

3 Select the Audio item to adjust

Press the [AUD] knob.

4 Adjust the Audio item

Turn the [AUD] knob.

5 Exit Audio Control mode

Press any button.

Press a button other than the [AUD] knob or [▲] and [ATT] button.

Audio Setup

You can set Sound system , such as follows;

Adjustment Item	Display	Range
Front High Pass Filter	"HPF-F"	Through/80/100/120/ 150/180 Hz
Rear High Pass Filter	"HPF-R"	Through/80/100/120/ 150/180 Hz
Low Pass Filter	"LPF"	60/80/120/Through Hz
Subwoofer Phase	"SW PHASE"	Reverse (180°)/ Normal (0°)
Volume offset	"VOL-OFFSET"	-8 — ±0 (AUX: -8 — +8)
Loudness	"LOUD"	OFF/ON
Dual Zone System	"2 ZONE"	OFF/ON



- Volume offset: Sets each source's volume as a difference from the basic volume.
- Loudness: Compensates for low and high tones during low volume. (Only the low tone is compensated for when the tuner is selected as a source.)
- Dual Zone System
 - Main source and sub source (Auxiliary input) output Front channel and Rear channel separately.
 - Set up the channel of sub source by "Zone2" of <Function Control> (page 6).
 - Select Main source by [SRC] button.
 - Adjust the volume of Front channel by [AUD] knob.
 - Adjust the volume of Rear channel by <Audio Control> (page 15) or [▲]/[▼] button on the remote control (page 19).
 - The Audio Control has no effect on sub source.

1 Select the source to adjust

For how to select source item, refer to <Power/Source Select button> of <Basic Operation> (page 4).

2 Enter Audio Setup mode

Press the [AUD] knob for at least 1 second.

3 Select the Audio Setup item to adjust

Press the [AUD] knob.

4 Adjust the Audio setup item

Turn the [AUD] knob.

5 Exit Audio Setup mode

Press the [AUD] knob for at least 1 second.

Audio Adjustments

Speaker Setting

Fine-tuning so that the System Q value is optimal when setting the speaker type as follows;

Speaker type	Display
OFF	"OFF"
For 5 & 4 in. speaker	"5/4inch"
For 6 & 6x9 in. speaker	"6x9/6inch"
For the OEM speaker	"O.E.M."

1 Enter Standby

Select the "STANDBY" display.

For how to select source item, refer to <Power/Source Select button> of <Basic Operation> (page 4).

2 Enter Speaker Setting mode

Press the [AUD] knob.

"SP SEL" is displayed.

3 Select the Speaker type

Turn the [AUD] knob.

4 Exit Speaker Setting mode

Press the [AUD] knob.

Audio Preset Memory

Registering the value setup by Sound Control. The memory cannot be erased by the Reset button.

1 Setup Sound Control

Refer to the following operations to setup the Sound Control.

- <Audio Control> (page 15)

- <Audio Setup> (page 15)

2 Select Audio Preset item during Menu mode (Other than Standby mode)

Select the "Audio Preset" display.

For how to select Function Control items, refer to <Function Control> (page 6).

3 Enter Audio Preset mode

Press the Control knob for at least 1 second.

4 Select the Audio Preset Memory

Turn the Control knob.

Select the "Memory" display.

5 Determine whether to put the Audio Preset in the memory

Press the Control knob.

"Memory?" is displayed.

6 Put the Audio Preset in the memory

Select "YES" using the Control knob.

Press the Control knob.

"Memory Completed" is displayed.

7 Exit Audio Preset mode

Press the [FNC] button.



- Register 1 pair of Audio Preset Memory. You cannot register by the source.
- When you press the Reset, all the sources will be the setting value which is registered.
- The following items cannot be registered. Volume, Balance, Fader, Loudness, Volume offset, Dual Zone System, Rear Volume

Audio Preset Recall

Recalling the sound setup registered by <Audio Preset Memory> (page 16).

1 Select the source

For how to select source item, refer to <Power/ Source Select button> of <Basic Operation> (page 4).

2 Select Audio Preset item during Menu mode (Other than Standby mode)

Select the "Audio Preset" display.

For how to select Function Control items, refer to <Function Control> (page 6).

3 Enter Audio Preset mode

Press the Control knob for at least 1 second.

4 Select the Audio Preset Recall

Turn the Control knob.

Select the "Recall" display.

5 Determine whether to recall the Audio Preset

Press the Control knob.

"Recall?" is displayed.

6 Recall the Audio Preset

Select "YES" using the Control knob.

Press the Control knob.

"Recall Completed" is displayed.

7 Exit Audio Preset mode

Press the [FNC] button.



- The User memory of "SYSTEM Q" in <Audio Control> (page 15) is changed to the value which was recalled.
- The source tone memory item of <Audio Control> (page 15) is changed to the value which was recalled by the selected source.

TV control (Optional)

Basic Operation

Selecting TV source

Press the [SRC] button.

Select the "TV" display.

For how to select source item, refer to <Power/Source Select button> of <Basic Operation> (page 4).

Select the TV band and Video input

Push the Control knob toward up.

Each time you push the knob, TV bands and Video input alternate.

Select the TV channel

Push the Control knob towards right or left.

Preset Memory

Putting the TV channels in the memory.

1 Select the TV channel to put in the memory

Push the Control knob towards right or left.

2 Enter Preset Memory mode

Select "P.MEM".

For how to select Function Control item, refer to <Function Control> (page 6).

3 Select the number to put in the memory

Turn the Control knob.

4 Determine the number to put in the memory

Press the Control knob.

5 Allow the determined number to take effect

Press the Control knob.

Canceling the Preset Memory mode

Press the [FNC] button.

Preset Tuning

Recalling the TV channels in the memory.

1 Enter Preset Tuning Select mode

Turn the Control knob.

A list is displayed.

2 Select a desired station in the memory

Turn the Control knob.

3 Recall the station

Press the Control knob.

Canceling Preset Tuning

Press the [FNC] button.

Function of remote control

Direct TV Tuning

Entering the TV channel and tuning.

1 Enter Direct TV Tuning mode

Press the [DIRECT] button on the remote control.

"--" is displayed.

2 Enter the TV channel

Press the number buttons on the remote control.

Example:

Desired channel	Press button
8 ch	[0], [8]

Canceling Direct TV Tuning

Press the [DIRECT] button on the remote control.

Basic Operations of remote control

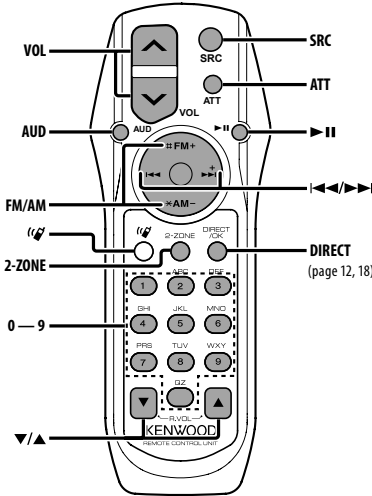

General control

- Volume control [VOL]
- Source select [SRC]
- Volume reduce [ATT]

In Audio control

- Audio item select [AUD]
- Adjusts the Audio item [VOL]



- Refer to <Audio Control> (page 15) for the operation method, such as the procedures for Audio control and others operations.

Dual Zone control

- Dual zone system on and off [2-ZONE]
- Rear channel volume control [▲]/[▼]

In Tuner source

- Band select [FM]/[AM]
- Station select [◀]/[▶]
- Recall preset stations [1] — [6]

In CD/USB source

- Music select [◀]/[▶]
- Folder/Disc select [FM]/[AM]
- Pause/Play [▶ II]

In TV source

- Band/Video input select [FM]
- Channel select [◀]/[▶]
- Recall preset channels [1] — [6]



About [📞]

This button is used when Bluetooth HANDS FREE BOX is connected. For more information, refer to the instruction manual of Bluetooth HANDS FREE BOX.



- Do not set the remote control in hot places such as on the dashboard.

Loading and Replacing battery

Use two "AA" / "R6"-size batteries. Slide the cover while pressing downwards to remove it as illustrated. Insert the batteries with the + and - poles aligned properly, following the illustration inside the case.

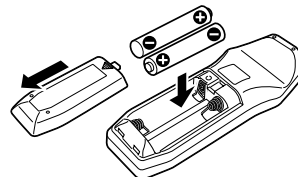

Appendix

About Audio file

- **Playable Audio file**
AAC-LC (.m4a), MP3 (.mp3), WMA (.wma)
- **Playable disc media**
CD-R/RW/ROM
- **Playable disc file format**
ISO 9660 Level 1/2, Joliet, Romeo, Long file name.
- **USB device Playable Model**
KDC-MP6539U
- **Playable USB device**
USB mass storage class
- **Playable USB device file system**
FAT16, FAT32
- **iPod Playable Model**
KDC-MP6539U

Although the audio files are complied with the standards listed above, the play maybe impossible depending on the types or conditions of media or device.

• Playable order of the Audio file

In the example of folder/file tree shown below, the files are played in the order from ① to ⑩.

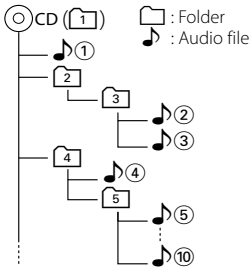

An online manual about audio files is put on the site, www.kenwood.com/audiofile/. On this online manual, detailed information and notes which are not written in this manual are provided. Make sure to read through the online manual as well.



- In this manual, the word “USB device” is used for flash memories and digital audio players which have USB terminals.
- The word “iPod” appearing in this manual indicates the iPod connected with the iPod connection cable (optional accessory). The iPod connected with the iPod connection cable can be controlled from this unit. iPods that can be connected with the iPod connection cable are the iPod nano, Fifth Generation iPod, iPod classic, and iPod touch. Other iPods cannot be connected. (KDC-MP6539U only)

About USB device

- If you start playback after connecting the iPod, the music that has been played by the iPod is played first.
In this case, “RESUMING” is displayed without displaying a folder name, etc. Changing the browse item will display a correct title, etc.
- When the iPod is connected to this unit, “KENWOOD” or “✓” is displayed on the iPod to indicate that you cannot operate the iPod.
- When the USB device is connected to this unit, it can be charged up provided that this unit is powered.
- Install the USB device in the place where it will not prevent you from driving your vehicle properly.
- You cannot connect a USB device via a USB hub and Multi Card Reader.
- Take backups of the audio files used with this unit. The files can be erased depending on the operating conditions of the USB device.
We shall have no compensation for any damage arising out of erasure of the stored data.
- No USB device comes with this unit. You need to purchase a commercially available USB device.
- When connecting the USB device, usage of the CA-U1EX (option) is recommended.
Normal playback is not guaranteed when a cable other than the USB compatible cable is used.
Connecting a cable whose total length is longer than 5 m can result in abnormal playback.

About KENWOOD “Music Editor” of PC application attached to KDC-MP6539U

- “Music Editor” is recorded in the CD-ROM attached to this unit.
- Refer to the user’s manual recorded in the installation CD-ROM and Help of “Music Editor” for the operation method of “Music Editor”.
- The unit can play USB device created by “Music Editor”.
- Information about “Music Editor” upgrade is put on the site, www.kenwood.com.

For operating KCA-BT100 (Optional)

However, the following control methods of the function for this unit may be different from the Instruction manual; therefore, refer to the following supplemental instruction.

<Dialing by Using the Quick Dialing Function>

1. Press the Control knob. Select the “DIAL” display.
2. Press the [FNC] button.
3. Select the number to recall by turning the Control knob.
4. Press the Control knob.

<Registering to the Preset Dial Number List>

1. Operation is the same. Refer to the instruction manual of KCA-BT100.
2. Press the [FNC] button.
3. Select the number to memory by turning the Control knob.
4. Press the Control knob for at least 1 second.

<Deleting a Registered Cell-Phone>

- 1-3. Operation is the same. Refer to the instruction manual of KCA-BT100.
4. Press the Control knob.
5. Select "YES" using the Control knob.
6. Press the Control knob.
7. Press the [FNC] button.

<Menu System>

For how to operate Menu, refer to <Function Control> in this instruction manual.

About display

Cell-Phone Status is displayed in the status display of this unit.

Moreover, some displays are different from the description of KCA-BT100 Instruction Manual.

Displays of KCA-BT100 Instruction Manual	Actual displays on this unit
"Disconnect"	"HF Disconnect"
"Connect"	"HF Connect"
"Phone Delete"	"Device Delete"
"Phone Status"	"BT DVC Status"

BT : Displays the bluetooth connection status.
This indicator turns on when a cell-phone is connected to this unit.

Menu Glossary

• SRC Select

Setting up the Source Select mode.

- 1 : Displays source icons for your choice.
- 2 : Allows you to select sources one after another.

• Display

If this unit is not operated at least 5 seconds with "OFF" selected, the display turns off. During a setup mode, the display will not turn off even if 5 seconds lapse.

• ILM Dimmer (illumination dimmer)

Reduces the key illumination brightness.

AUTO: Dims the illumination in conjunction with the Light switch of the vehicle.

MNAL1/MNAL: Dims the illumination constantly.

MNAL2: Turns off the upper and lower illuminations, and dims the left and right illuminations.

OFF: Does not dim the illumination.

• AT COL CHG (Automatic illumination color change)

Selecting "iPod" changes the key illumination automatically according to the color of the iPod

body during playback of the iPod source.

* The color of key illumination is only a recommended color by our company. It does not necessarily match the body color of iPod.

Compatible iPod models:

iPod (5th generation), iPod touch, iPod nano (1st/2nd/3rd generation), Fifth Generation iPod (iPod with video)

• AMP

Selecting "OFF" turns off the built-in amplifier. Turning off the built-in amplifier improves the quality of the sound from Preout.

• Zone2 (Dual Zone)

Set the destination (front speaker "Front" or rear speaker "Rear") of the sub source (AUX IN) when the Dual Zone function is turned on.

• Supreme

Technology to extrapolate and supplement with proprietary algorithm, the high-frequency range that is cut off when encoding at low bit rate (less than 128Kbps, Sampling frequency is 44.1kHz). Supplementing is optimized by compression format (AAC, MP3 or WMA) and processed according to bit rate. The effect is negligible with music that is encoded at high bit rate, variable bit rate or has minimal high frequency range.

• Chinese (Chinese language setting)

When this is set to ON, the following character strings are displayed in Chinese:

Folder name/ File name/ Song title/ Artist name/ Album name/ KCA-BT100 (optional accessory)

• CD Read

Sets the method for reading CD.

When unable to play special format CD, set this function to "2" to force playing. Note that some music CD may be unplayable even when set to "2". In addition, audio files cannot be played when set to "2". Normally, keep this set to "1".

1 : Automatically distinguishes between audio file disc and music CD when playing disc.

2 : Forces playing as music CD.

The marking of products using lasers (Except for some areas)

**CLASS 1
LASER PRODUCT**

The label is attached to the chassis/case and says that the component uses laser beams that have been classified as Class 1. It means that the unit is utilizing laser beams that are of a weaker class. There is no danger of hazardous radiation outside the unit.

Accessories/ Installation Procedure

Accessories

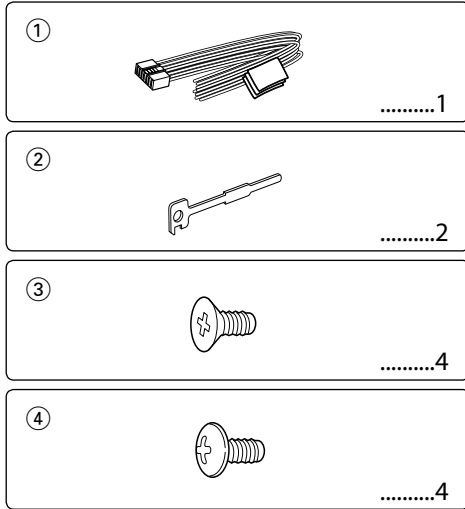

- Do not use your own screws. Use only the screws provided. If you use the wrong screws, you could damage the unit.
- If the power is not turned ON ("Protect" is displayed), the speaker wire may have a short-circuit or touched the chassis of the vehicle and the protection function may have been activated. Therefore, the speaker wire should be checked.
- If your car's ignition does not have an ACC position, connect the ignition wires to a power source that can be turned on and off with the ignition key. If you connect the ignition wire to a power source with a constant voltage supply, as with battery wires, the battery may die.
- If the console has a lid, make sure to install the unit so that the faceplate will not hit the lid when closing and opening.
- If the fuse blows, first make sure the wires aren't touching to cause a short circuit, then replace the old fuse with one with the same rating.
- Insulate unconnected wires with vinyl tape or other similar material. To prevent a short circuit, do not remove the caps on the ends of the unconnected wires or the terminals.
- Connect the speaker wires correctly to the terminals to which they correspond. The unit may be damaged or fail to work if you share the ⊖ wires or ground them to any metal part in the car.
- When only two speakers are being connected to the system, connect the connectors either to both the front output terminals or to both the rear output terminals (do not mix front and rear). For example, if you connect the ⊕ connector of the left speaker to a front output terminal, do not connect the ⊖ connector to a rear output terminal.
- After the unit is installed, check whether the brake lamps, blinkers, wipers, etc. on the car are working properly.
- Mount the unit so that the mounting angle is 30° or less.

Installation Procedure

1. To prevent a short circuit, remove the key from the ignition and disconnect the ⊖ battery.
2. Make the proper input and output wire connections for each unit.
3. Connect the speaker wires of the wiring harness.
4. Connect the wiring harness wires in the following order: ground, battery, ignition.
5. Connect the wiring harness connector to the unit.
6. Install the unit in your car.
7. Reconnect the ⊖ battery.
8. Press the reset button.

▲WARNING

If you connect the ignition wire (red) and the battery wire (yellow) to the car chassis (ground), you may cause a short circuit, that in turn may start a fire. Always connect those wires to the power source running through the fuse box.



- Mounting and wiring this product requires skills and experience. For safety's sake, leave the mounting and wiring work to professionals.
- Make sure to ground the unit to a negative 12V DC power supply.
- Do not install the unit in a spot exposed to direct sunlight or excessive heat or humidity. Also avoid places with too much dust or the possibility of water splashing.

About CD players/disc changers connected to this unit

If the CD player/ disc changer has the "O-N" switch, set it to the "N" position.

The functions you can use and the information that can be displayed may differ depending on the models being connected.

Connecting Wires to Terminals

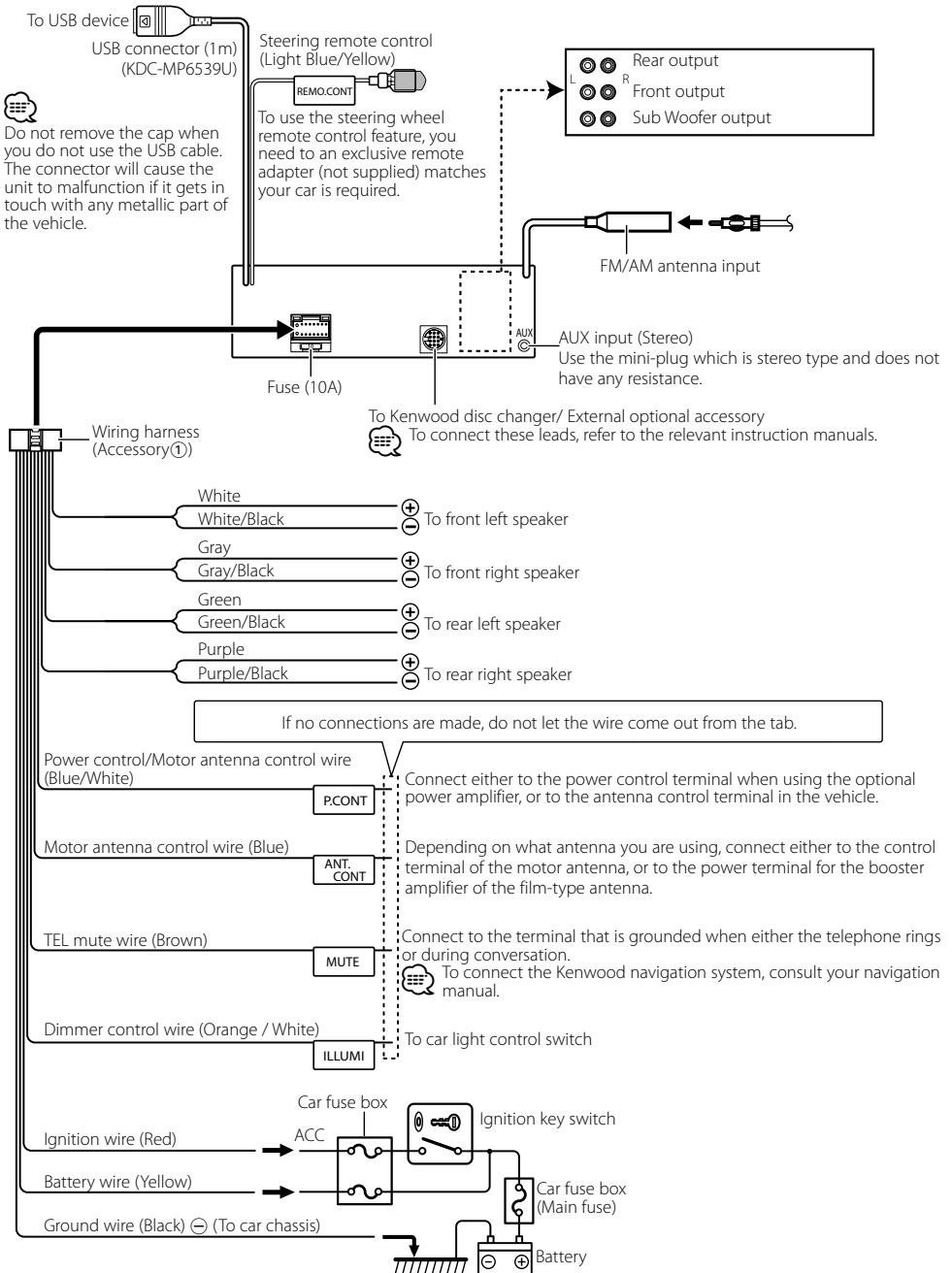

Installation/Removing the Unit

non-Japanese cars

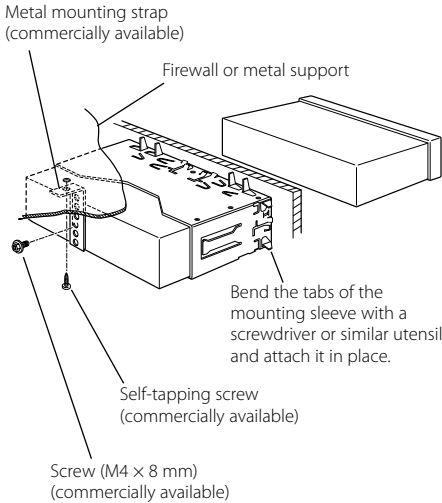

- Make sure that the unit is installed securely in place. If the unit is unstable, it may malfunction (for example, the sound may skip).

Japanese cars

- 1 Refer to the section <Removing the hard rubber frame> and then remove the hard rubber frame.
- 2 Align the holes in the unit (two locations on each side) with the vehicle mounting bracket and secure the unit with the accessory screws.

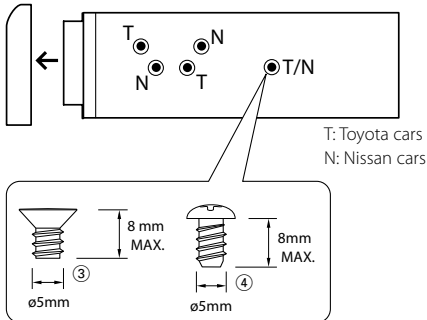

Accessory③...for Nissan car
Accessory④...for Toyota car

Removing the hard rubber frame

- 1 Engage the catch pins on the removal tool and remove the two locks on the upper level. Upper the frame and pull it forward as shown in the figure.

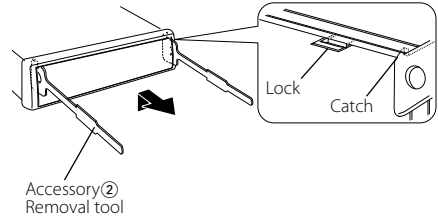

- 2 When the upper level is removed, remove the lower two locations.



- The frame can be removed from the bottom side in the same manner.

Removing the Unit

- 1 Refer to the section <Removing the hard rubber frame> and then remove the hard rubber frame.
- 2 Remove the screw (M4 x 8) on the back panel.
- 3 Insert the two removal tools deeply into the slots on each side, as shown.
- 4 Lower the removal tool toward the bottom, and pull out the unit halfway while pressing towards the inside.

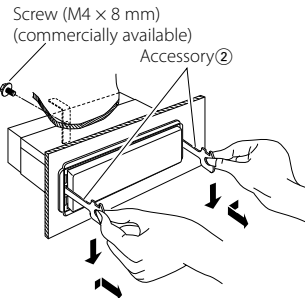

- Be careful to avoid injury from the catch pins on the removal tool.

- 5 Pull the unit all the way out with your hands, being careful not to drop it.

Troubleshooting Guide

Some functions of this unit may be disabled by some settings made on this unit.

- !** • **Cannot set up the subwoofer.**
- **Cannot set up the High Pass Filter.**
- **Cannot set up the Fader.**
- **No Audio control effect on AUX.**
 - ▶ • <Subwoofer output> of <Basic Operation> (page 4) is not set to On.
 - The Dual zone function is enabled. [Ⓜ] <Audio Setup> (page 15)

- !** • **Cannot set up the subwoofer phase.**
 - ▶ The Low Pass Filter is set to Through. [Ⓜ] <Audio Setup> (page 15)

- !** • **Cannot select the output destination of the subsource in the Dual zone.**
- **Cannot adjust the volume of the rear speakers.**
 - ▶ The Dual zone function is disabled. [Ⓜ] <Audio Setup> (page 15)

- !** • **Cannot register a security code.**
- **Cannot set up Display Illumination Control.**
 - ▶ <Demonstration mode Setting> (page 14) is not turned off.

What might seem to be a malfunction in your unit may just be the result of slight misoperation or miswiring. Before calling service, first check the following table for possible problems.

General

? The Touch Sensor Tone does not sound.

- ✓ The preout jack is being used.
 - [Ⓜ] The Touch Sensor Tone cannot be output from the preout jack.

? The illumination flashes when the knob or button is operated.

- ✓ This is the key illumination effect.
 - [Ⓜ] You set this effect in "MENU" > "ILM Effect" of <Function Control> (page 6).

? The key illumination effect brought about in conjunction with the sound volume is small.

- ✓ The key illumination effect may be insufficient depending on the sound volume and sound quality.

Tuner source

? Radio reception is poor.

- ✓ The car antenna is not extended.
 - [Ⓜ] Pull the antenna out all the way.

Disc source

? The specified disc does not play, but another one plays instead.

- ✓ The specified CD is quite dirty.
 - [Ⓜ] Clean the CD, referring to the CD cleaning of the section on <Handling CDs> (page 3).
- ✓ The disc is loaded in a different slot from that specified.
 - [Ⓜ] Eject the disc magazine and check the number for the specified disc.
- ✓ The disc is severely scratched.
 - [Ⓜ] Try another disc instead.

Audio file source

? The sound skips when an Audio file is being played.

- ✓ The media is scratched or dirty.
 - [Ⓜ] Clean the media, referring to the CD cleaning of the section on <Handling CDs> (page 3).
- ✓ The recording condition is bad.
 - [Ⓜ] Record the media again or use another media.

? Noise is heard when carrying out Folder Search.

- ✓ Noise may be produced if folders without audio files exist continuously in the playing media.
 - [Ⓜ] Do not make folders without audio files.

Troubleshooting Guide

The messages shown below display your systems condition.

- TOC Error:**
- No disc has been loaded in the disc magazine.
 - The CD is quite dirty. The CD is upside-down. The CD is scratched a lot.
- Error 05:** The disc is unreadable.
- Error 77:** The unit is malfunctioning for some reason.
- ✦ Press the reset button on the unit. If the "Error 77" code does not disappear, consult your nearest service center.
- Mecha Error:** Something is wrong with the disc magazine. Or the unit is malfunctioning for some reason.
- ✦ Check the disc magazine. And then press the reset button on the unit. If the "Mecha Error" code does not disappear, consult your nearest service center.
- IN (Blink):** The CD player section is not operating properly.
- ✦ Reinsert the CD. If the CD cannot be ejected or the display continues to flash even when the CD has been properly reinserted, please switch off the power and consult your nearest service center.
- Protect:** The speaker wire has a short-circuit or touches the chassis of the vehicle, and then the protection function is activated.
- ✦ Wire or insulate the speaker cable properly and press the reset button. If the "Protect" code does not disappear, consult your nearest service center.
- Unsupported File:**
An Audio file is played with a format that this unit can't support.
- Copy Protect:**
Copy Protection:
A copy-protected file is played.
- Read Error:** The file system of the connected USB device is broken.
- ✦ Copy the files and folders for the USB device again. If the error message is still displayed, initialize the USB device or use other USB devices.
- No Device:** The USB device is selected as a source although no USB device is connected.
- ✦ Change the source to any source other than USB. Connect an USB device, and change the source to USB again.
- N/A Device:** An unsupported USB device is connected.
- No Music Data/ Error 15:**
- The connected USB device contains no playable audio file.
 - Media was played that does not have data recorded that the unit can play.

USB ERROR (Blink):

Some trouble may have occurred to the connected USB device.

- ✦ Remove the USB device, then cycle the power switch to ON. If the same display is repeated, use another USB device.

iPod Error:

Connection to the iPod has failed.

- ✦ Check that the connected iPod is an iPod that is supported. See <About Audio file> (page 20) for information on supported iPods.
- ✦ Remove the USB device and then reconnect it.
- ✦ Confirm that the software for the iPod is the latest version.

USB REMOVE:

The Remove mode has been selected for the USB device/iPod. You can remove the USB device/iPod safely.

Specifications

FM tuner section

- Frequency range
 - 200 kHz space
 - : 87.9 MHz – 107.9 MHz
 - 50 kHz space
 - : 87.5 MHz – 108.0 MHz
- Usable sensitivity (S/N = 30dB)
 - : 9.3dBf (0.8 μ V/75 Ω)
- Quieting Sensitivity (S/N = 50dB)
 - : 15.2dBf (1.6 μ V/75 Ω)
- Frequency response (\pm 3 dB)
 - : 30 Hz – 15 kHz
- Signal to Noise ratio (MONO)
 - : 70 dB
- Selectivity (\pm 400 kHz)
 - : \geq 80 dB
- Stereo separation (1 kHz)
 - : 40 dB

AM tuner section

- Frequency range
 - 10 kHz space
 - : 530 kHz – 1700 kHz
 - 9 kHz space
 - : 531 kHz – 1611 kHz
- Usable sensitivity (S/N = 20dB)
 - : 28 dB μ (25 μ V)

CD player section

- Laser diode
 - : GaAlAs
- Digital filter (D/A)
 - : 8 Times Over Sampling
- D/A Converter
 - : 24 Bit
- Spindle speed
 - : 500 – 200 rpm (CLV)
- Wow & Flutter
 - : Below Measurable Limit
- Frequency response (\pm 1 dB)
 - : 10 Hz – 20 kHz
- Total harmonic distortion (1 kHz)
 - KDC-MP6539U: 0.008 %
 - KDC-MP6039: 0.010 %
- Signal to Noise ratio (1 kHz)
 - KDC-MP6539U: 110 dB
 - KDC-MP6039: 105 dB
- Dynamic range
 - : 93 dB
- MP3 decode
 - : Compliant with MPEG-1/2 Audio Layer-3
- WMA decode
 - : Compliant with Windows Media Audio
- AAC decode
 - : AAC-LC “.m4a” files

USB Interface (KDC-MP6539U)

- USB Standard
 - : USB1.1/ 2.0
- Maximum Supply current
 - : 500 mA
- File System
 - : FAT16/ 32
- MP3 decode
 - : Compliant with MPEG-1/2 Audio Layer-3
- WMA decode
 - : Compliant with Windows Media Audio
- AAC decode
 - : AAC-LC “.m4a” files

Audio section

- Maximum output power
 - : 50 W x 4
- Full Bandwidth Power (at less than 1% THD)
 - : 22 W x 4
- Speaker Impedance
 - : 4 – 8 Ω
- Tone action
 - Bass : 100 Hz \pm 8 dB
 - Middle : 1 kHz \pm 8 dB
 - Treble : 10 kHz \pm 8 dB
- Preout level / Load (CD)
 - : 2500 mV/10 k Ω
- Preout impedance
 - : \leq 600 Ω

Auxiliary input

- Frequency response (\pm 1 dB)
 - : 20 Hz – 20 kHz
- Input Maximum Voltage
 - : 1200 mV
- Input Impedance
 - : 100 k Ω

General

- Operating voltage (11 – 16V allowable)
 - : 14.4 V
- Current consumption
 - : 10 A
- Installation Size (W x H x D)
 - : 182 x 53 x 155 mm
- Weight
 - : 1.40 kg

