

KENWOOD

KDC-X617
KDC-V6017
KDC-516S
KDC-57MR

Take the time to read through this instruction manual.

Familiarity with installation and operation procedures will help you obtain the best performance from your new CD-receiver.

For your records

Record the serial number, found on the back of the unit, in the spaces designated on the warranty card, and in the space provided below. Refer to the model and serial numbers whenever you call upon your KENWOOD dealer for information or service on the product.

Model KDC-X617/V6017/516S/57MR

Serial number _____

CD-RECEIVER

INSTRUCTION MANUAL

AMPLI-TUNER-LECTEUR DE CD

MODE D'EMPLOI

REPRODUCTOR DE DISCOS COMPACTOS RECEPTOR DE FM/AM

MANUAL DE INSTRUCCIONES

KENWOOD CORPORATION



© B64-1876-00 (KW)

Contents

Safety precautions

Warning.....	3
Safety precautions	4
Handling Compact discs	6

General features

Power.....	8
Switching Modes.....	8
Volume.....	9
Attenuator.....	9
Loudness.....	9
Non-Fading Output.....	9
Theft Deterrent Faceplate.....	10
System Q.....	11
Speaker & Woofer setting.....	11
Clock display.....	12

Audio control features

Audio Control Setting.....	13
Bass Center Frequency.....	13
Bass Level.....	13
Bass Quality Factor.....	13
Bass Extend.....	13
Middle Center Frequency.....	14
Middle Level.....	14
Middle Quality Factor.....	14
Treble Center Frequency.....	14
Treble Level.....	14
Balance Level.....	14
Fader Level.....	14
Non-Fading Level.....	14
High-pass Filter Frequency for Front Output.....	15
High-pass Filter Frequency for Rear Output.....	15
Low-pass Filter Frequency for Non-Fading Output.....	15
Phase for Non-Fading Output.....	15
Volume Offset.....	15

Tuner features

Tuning.....	16
Direct Access Tuning.....	17
Station Preset Memory.....	17
Auto Memory Entry.....	17
Station Name Preset (SNPS).....	18
Switching Display for Tuner.....	18

CD/External disc control features

Playing CDs.....	20
Playing Other Disc mode.....	20
Switching Display for Discs.....	21
Fast Forwarding and Reversing Disc Play.....	21
Track Search.....	21
Disc Search.....	22
Track / Disc Repeat.....	22
Track Scan.....	22
Random Play.....	22
Magazine Random Play.....	23
Text / Title Scroll.....	23
Presetting Disc Names (DNPS).....	24
Disc Name Preset Play (DNPP).....	25
Direct Track Search.....	25
Direct Disc Search.....	26

Menu settings

Menu System.....	27
Security Code.....	28
Touch Sensor Tone.....	29
Manual Time Adjustment.....	29
Selectable Illumination.....	29
Switching Graphic Display.....	29
Variable Illumination Color Setting.....	30
Contrast Adjustment.....	30
Dimmer.....	30
System Q.....	31
External Amp Control.....	31
Clean Reception System Circuit (CRSC).....	31
Text Scroll.....	31

Basic Operations of remote

Basic operations.....	32
Tuner features.....	33
CD/External disc control features.....	34

Installation

Accessories.....	35
Installation Procedure.....	35
Connecting Wires to Terminals.....	36
Installation.....	37

Troubleshooting Guide.....40

Specifications.....44

▲ Warning

▲ CAUTION

Use of controls or adjustments or performance of procedures other than those specified herein may result in hazardous radiation exposure.

In compliance with Federal Regulations, following are reproductions of labels on, or inside the product relating to laser product safety.

KENWOOD CORPORATION
2967-3, ISHIKAWA-CHO,
HACHIOJI-SHI
TOKYO, JAPAN

KENWOOD CORP. CERTIFIES THIS EQUIPMENT
CONFORMS TO DHHS REGULATIONS NO.21 CFR
1040. 10, CHAPTER 1, SUBCHAPTER J.

Location : Bottom Panel

FCC WARNING

This equipment may generate or use radio frequency energy. Changes or modifications to this equipment may cause harmful interference unless the modifications are expressly approved in the instruction manual. The user could lose the authority to operate this equipment if an unauthorized change or modification is made.

NOTE

This equipment has been tested and found to comply with the limits for a Class B digital device, pursuant to Part 15 of the FCC Rules. These limits are designed to provide reasonable protection against harmful interference in a residential installation. This equipment may cause harmful interference to radio communications, if it is not installed and used in accordance with the instructions. However, there is no guarantee that interference will not occur in a particular installation. If this equipment does cause harmful interference to radio or television reception, which can be determined by turning the equipment off and on, the user is encouraged to try to correct the interference by one or more of the following measures:

- Reorient or relocate the receiving antenna.
- Increase the separation between the equipment and receiver.
- Connect the equipment into an outlet on a circuit different from that to which the receiver is connected.
- Consult the dealer or an experienced radio/TV technician for help.

NOTE

This Class B digital apparatus complies with Canadian ICES-003.

Safety precautions

▲WARNING

To prevent injury or fire, take the following precautions:

- Insert the unit all the way in until it is fully locked in place. Otherwise it may fall out of place when jolted.
- When extending the ignition, battery, or ground wires, make sure to use automotive-grade wires or other wires with a 0.75mm² (AWG18) or more to prevent wire deterioration and damage to the wire coating.
- To prevent a short circuit, never put or leave any metallic objects (such as coins or metal tools) inside the unit.
- If the unit starts to emit smoke or strange smells, turn off the power immediately and consult your Kenwood dealer.
- Make sure not to get your fingers caught between the faceplate and the unit.
- Be careful not to drop the unit or subject it to strong shock.
The unit may break or crack because it contains glass parts.
- Do not touch the liquid crystal fluid if the LCD is damaged or broken due to shock. The liquid crystal fluid may be dangerous to your health or even fatal.
If the liquid crystal fluid from the LCD contacts your body or clothing, wash it off with soap immediately.

▲CAUTION

To prevent damage to the machine, take the following precautions:

- Make sure to ground the unit to a negative 12V DC power supply.
- Do not open the top or bottom covers of the unit.
- Do not install the unit in a spot exposed to direct sunlight or excessive heat or humidity. Also avoid places with too much dust or the possibility of water splashing.
- Do not subject the faceplate to excessive shock, as it is a piece of precision equipment.
- When replacing a fuse, only use a new one with the prescribed rating. Using a fuse with the wrong rating may cause your unit to malfunction.
- To prevent a short circuit when replacing a fuse, first disconnect the wiring harness.
- Do not place any object between the faceplate and the unit.
- Do not use your own screws. Use only the screws provided. If you use the wrong screws, you could damage the unit.
- Do not apply excessive force to the moving faceplate. Doing so will cause damage or malfunction.
- Do not apply excessive force to the open faceplate or place objects on it. Doing so will cause damage or breakdown.

IMPORTANT INFORMATION

About the disc changer to be connected:

To connect a disc changer having the "O-N" switch to this unit, set the "O-N" switch to "N".

When you connect a model with no "O-N" switch, the converter cord CA-DS100 available as an option may be required. For details, consult your Kenwood dealer. If a model with no "O-N" switch is connected, some unavailable functions and information that cannot be displayed are generated, such as the DNPS, DNPP, Magazine random play, and CD Text display. Note that none of the KDC-C100, KDC-C302, C205, C705, and non-Kenwood CD changers can be connected.

▲CAUTION

You can damage both your unit and the CD changer if you connect them incorrectly.

Do Not Load 3-in. CDs in the CD slot

If you try to load a 3 in. CD with its adapter into the unit, the adapter might separate from the CD and damage the unit.

NOTE

- If you experience problems during installation, consult your Kenwood dealer.
- Press the reset button if the disc auto changer is first controlled and operates incorrectly. The original operating condition will return.

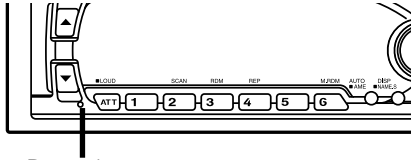

Reset button

- We recommend the use of the Security Code function (see p. 28) to prevent theft.
- Characters in the LCD may become difficult to read in temperatures below 41 °F (5 °C).

- The illustrations of the display and the panel appearing in this manual are examples used to explain more clearly how the controls are used. Therefore, what appears on the display in the illustrations may differ from what appears on the display on the actual equipment, and some of the illustrations on the display may represent something impossible in actual operation.
- The functions that can be used and the information that can be displayed will differ depending on the external disc players being connected.

Cleaning the Faceplate Terminals

If the terminals on the unit or faceplate get dirty, wipe them with a dry, soft cloth.

Cleaning the Unit

If the faceplate of this unit is stained, wipe it with a dry soft cloth such as a silicon cloth. If the faceplate is stained badly, wipe the stain off with a cloth moistened with neutral cleaner, then wipe neutral detergent off.

CAUTION

Applying spray cleaner directly to the unit may affect its mechanical parts. Wiping the faceplate with a hard cloth or using a volatile liquid such as thinner or alcohol may scratch the surface or erase characters.

Cleaning the CD Slot

As dust tends to accumulate in the CD slot, clean it every once in a while. Your CDs can get scratched if you put them in a dusty CD slot.

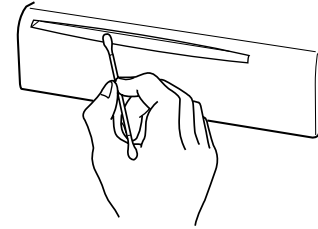

Lens Fogging

Right after you turn on the car heater in cold weather, dew or condensation may form on the lens in the CD player of the unit. Called lens fogging, CDs may be impossible to play. In such a situation, remove the disc and wait for the condensation to evaporate. If the unit still does not operate normally after a while, consult your Kenwood dealer.

Handling Compact discs

Playing a CD that is dirty, scratched or warped can cause the sound to skip and the unit to operate incorrectly, resulting in worsened sound quality. Take the following precautions to prevent your CDs from getting scratched or damaged.

Handling CDs

- Do not touch the recorded side of the CD (the side opposite the label) when holding it.

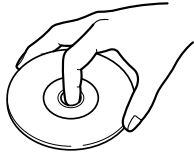

- The reflective film on a CD-R or a CD-RW is more fragile than that on an ordinary music CD, and may peel off if scratched. Fingerprints on a CD-R or CD-RW are also more likely to cause skipping when the disc is played. For these reasons, handle the disc very carefully. Detailed handling instructions will appear on the CD-R or CD-RW package: read this information carefully before using the disc.
- Do not stick tape on either side of the CD.

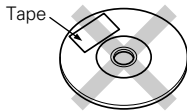

Storing CDs

- Do not store CDs in areas exposed to direct sunlight (such as a car seat or the dashboard) or other hot places. A CD-R or CD-RW is more susceptible than a music CD to damage from high temperatures and humidity, and in some cases, may become unusable if left in the car for long periods of time.
- Remove CDs from the unit when not listening to them for a while, and put them back in their cases. Do not pile up CDs that are removed from their cases or prop them against something.

Cleaning CDs

If a CD has gotten dirty, wipe it off gently using a commercially available cleaning cloth or a soft cotton cloth, starting from the center of the disc and moving outward. Do not clean CDs with conventional record cleaners, anti-static formulas, or chemicals such as paint thinner or benzene.

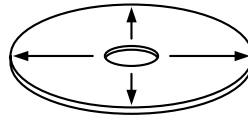

Checking New CDs for Burrs

When playing a new CD for the first time, check that there are not any burrs stuck to the perimeter of the disc or in the central hole. CDs with burrs stuck on them may not load properly or may skip while playing. Remove burrs using a ballpoint pen or a similar utensil.

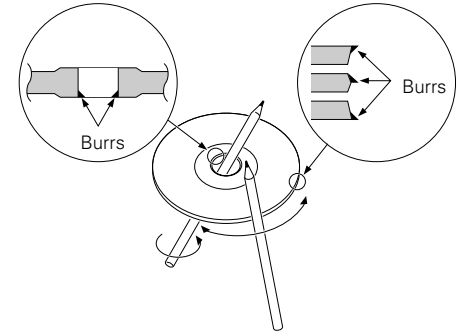

Do Not Load CD Accessories

Do not use commercially available CD accessories that can be loaded into the CD slot, such as stabilizers, protective sheets, or CD cleaning discs, since they can cause the unit to malfunction.

Removing the CD

Only remove the CD from the machine in a horizontal direction, holding it flat. You may damage the surface of the CD if you try pulling it down as it ejects.

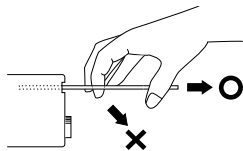

Do Not Use Special Shape CDs

- Be sure to use round shape CDs only for this unit and do not use any special shape CDs. Use of special shape CDs may cause the unit to malfunction.



- Be sure to use CDs with disc mark  only for this unit.
- CD-Rs and CD-RWs which have not undergone finalization processing cannot be played. (For more information on finalization processing, refer to the manual for your CD-R/CD-RW writing software or CD-R/CD-RW recorder.) Additionally, depending on the recording status, it may prove impossible to play certain CDs recorded on CD-R or CD-RW.

Do Not Use CDs with Sticker on the Labeled Side

Do not use the CD with the label sticker stuck on it.

Using such a CD may cause the CD to be deformed and the sticker to peel off, resulting in malfunction of the unit.

General features

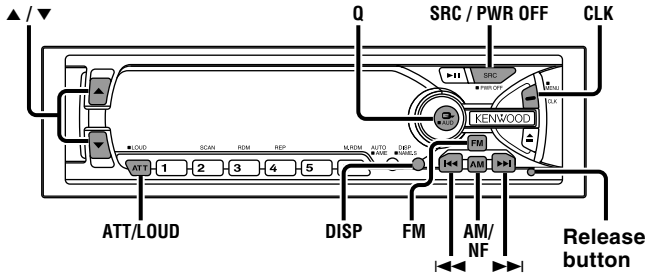

KDC-X617/KDC-516S/KDC-57MR

Clock indicator

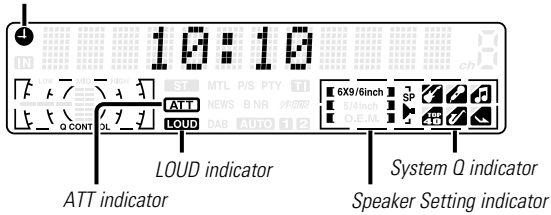

KDC-V6017

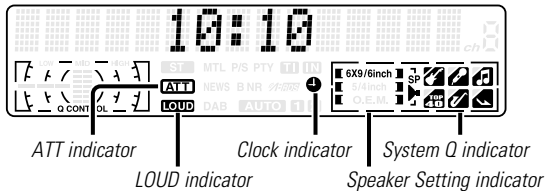

Power

Turning on the power:

Press the SRC (source) button.

NOTE

Turn the power on before carrying out the following procedures.

Turning off the power:

Press the PWR OFF button for at least one second.

NOTE

The status of the Security Code function (page 28) is displayed whenever the power is switched on.

"CODE ON" : Security Code has been registered

"CODE OFF" : Security Code has not been registered

Switching Modes

Switching Modes:

Each time you press the SRC (source) button, the mode switches as follows:

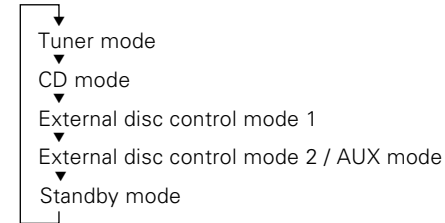

Selecting standby mode:

Press the SRC button repeatedly and switch to "ALL OFF". When "ALL OFF" is displayed, the standby mode is activated. The standby mode turns all functions off while leaving the power to the unit on. Use this mode when you want to have the display illuminated but don't want to listen to anything.

NOTE

- The mode switches to the next mode from any mode which cannot be used.
- The external disc control mode will differ depending on the unit that is connected.
- To enable the selection of External disc control mode 2/AUX mode, you should connect optional switching adapter KCA-S210A (which allows you to select both External disc control mode 2 and AUX mode) or CD changer (KDC-CPS87, KDC-CX87, KDC-CPS85, KDC-CX85, KDC-CPS82 or KDC-CX82) or switching adapter CA-C1AX (which allows you to select AUX mode only).
During the AUX mode, "AUX" (or AUX-name display) will show in the display. When the CA-C1AX is being used, the AUX Mode will replace the External Disc Control Mode.

NOTE

Selecting AUX-name display

Pressing the DISP button for at least two seconds during the AUX mode, AUX-name display is blinked for AUX-name selection mode.
Pressing **◀◀** or **▶▶** button during this mode allows you to select "AUX", "TV", "VCP", "GAME" or "PORTABLE" in the AUX mode.
The AUX-name selection mode can be exited by pressing the DISP button or doing nothing for 10 seconds.

Volume

Increasing Volume:

Press the **▲** button to turn up the volume.

Decreasing Volume:

Press the **▼** button to turn down the volume.

Attenuator

This function allows you to turn down the volume quickly.

Turning Attenuator On/Off:

Press the ATT button to switch the attenuator on and off.
When the attenuator is on, the ATT indicator blinks.
When the attenuator is off, the volume returns to the original level.

NOTE

Turning the volume up, or turning it all the way down deactivates the attenuator function.

Loudness

This function amplifies low and high tones when the volume is turned down.
The LOUD indicator lights up when the loudness function is on.

Turning Loudness On/Off:

Press the LOUD button for at least one second to switch the loudness on and off.

NOTE

The loudness function does not affect non-fading pre-out.

Function of the KDC-X617

Non-Fading Output

You can turn the non-fading output on and off.

Turning non-fading output On/Off :

Press the NF button for at least one second to set the function ON or OFF.
"NF ON" is displayed when the non-fading output is set ON.

General features

Theft Deterrent Faceplate

The faceplate can be reversed to hide the control panel or detached from the unit, helping to deter theft.

Removing the Faceplate:

- When the control panel is visible:
Press the release button.
 - When the control panel has been hidden:
Press the upper side of the faceplate.
- Holding the center part of the faceplate, pull it out.

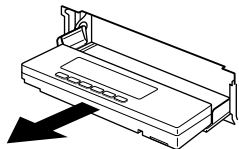

- Push back the bottom of the faceplate bracket until it locks.

▲CAUTION

- Do not apply excessive force to the faceplate bracket without attaching the faceplate. Doing so will cause the faceplate bracket to be deformed.
- Do not touch the connector on the faceplate bracket after removing the faceplate. Touching the connector may cause damage to the unit.

NOTE

- The faceplate is a precision piece of equipment and can be damaged by shocks or jolts. For that reason, keep the faceplate in its special storage case while detached.
- Do not expose the faceplate or its storage case to direct sunlight or excessive heat or humidity. Also avoid places with too much dust or the possibility of water splashing.

Reattaching the Faceplate:

- Hold the faceplate so that the control panel faces the front toward you and set the left side of the faceplate in the faceplate bracket.

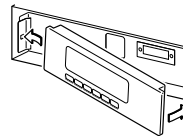

▲CAUTION

Do not set the right side of the faceplate in the faceplate bracket first, when reattaching the faceplate. Doing so may cause the connector on the faceplate bracket to malfunction.

- Press the right side of the faceplate until it locks.

Hiding the control panel:

- Press the release button and slide open the faceplate.
- Push upward the back of the control panel and reverse the panel.

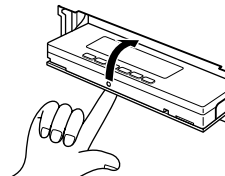

NOTE

The panel cannot be reversed when the faceplate is not attached.

Opening the control panel:

- Press the upper side of the faceplate.
The faceplate will open.
- Push the bottom of the control panel and close the faceplate.

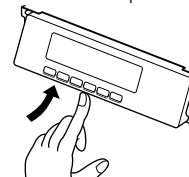

NOTE

While the control panel is sliding, only available buttons are ▲, ATT, ▲, ▼ and SRC.

System Q

You can recall the best audio setting preset for different types of the music.

Switching the Preset Sound Setting:

Each time you press the Q button, the preset sound setting switches as follows:

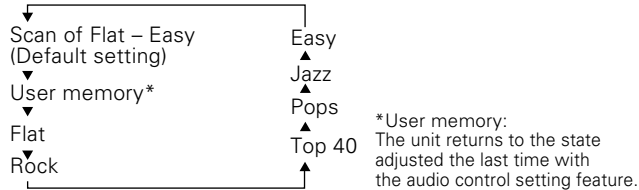

As you proceed, each indicator would go on.

NOTE

The System Q function changes the values of the following sound quality parameters:

Bass center frequency, bass level, bass quality factor, bass extend, middle center frequency, middle level, middle quality factor, treble center frequency, treble level, non-fading level, high-pass filter frequency for front output, high-pass filter frequency for rear output, and low-pass filter frequency for non-fading output.

Their setting values are different depending on the setting of the speaker setting mode.

Speaker & Woofer setting

Speaker setting allows the System Q settings to be fine-tuned according to the type of speakers.

Woofer setting allows for Network configuration according to the type of subwoofers.

- 1 Press the SRC button repeatedly to select the standby mode. "ALL OFF" is displayed when the standby mode is selected.
- 2 Press the Q button to enter the speaker setting mode.
- 3 Each time you press the FM/AM button, the mode switches as follows:

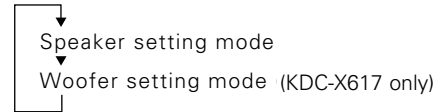

- 4
 - In speaker setting mode
Press either the ◀◀ or ▶▶ button to select the type of speaker. The setting switches as follows.
Off ("SP OFF") / For 6/6x9 in. speaker ("SP 6*9/6inch") / For 5/4 in. speaker ("SP 5/4inch") / For the OEM speaker ("SP O.E.M.")
 - In woofer setting mode
Press either the ◀◀ or ▶▶ button to select the type of Sub woofer. The setting switches as follows.
"WF OFF" / "WF 12inch A" / "WF 10inch A" / "WF 12inch B" / "WF 10inch B" / "WF 12inch C" / "WF 10inch C" / "WF 8inch" / "WF 12inch D" / "WF 10inch D"
- 5 Press the Q button to end the speaker setting mode and woofer setting mode.

NOTE

- Speaker setting function allows for tuning of bass, middle and treble.
- Woofer setting allows for tuning of high-pass filter frequency, low-pass filter frequency and non-fading level.

General features

Clock display

Changing the Clock Display:

Each time you press the CLK button, the display switches between the clock and each mode display.

NOTE

The clock indicator lights while the clock is displayed.

Audio control features

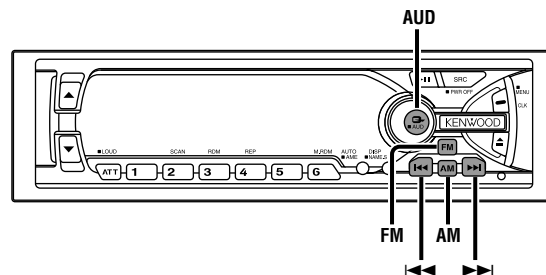

KDC-X617/KDC-516S/KDC-57MR

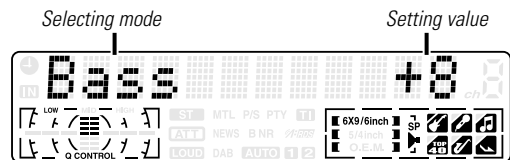

KDC-V6017

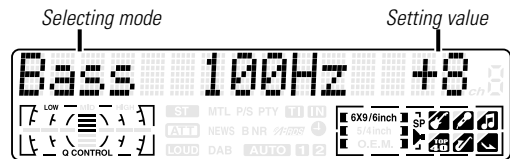

Audio Control Setting

Adjust various parameters of sound quality.

- 1 Press the AUD button for at least one second to enter the control mode.
- 2 **Selecting mode**
Press either the FM or AM button.
Each time the button is pressed, the adjustment mode will change.
Please refer to the following for the contents of the adjustment modes.

NOTE Source tone memory

Each source (CD, FM, AM and disc changer) has its own memory in which to store the bass, middle, treble and N-F level settings. (N-F level : KDC-X617 only)
The settings made for a particular source are recalled automatically whenever you use that source (for example, FM mode uses the tone settings made for FM, AM for AM, etc.).

- 3 **Adjust each mode**
Press the **I◀◀/▶▶I** button.
Please refer to the following for the adjusting values.
- 4 Press the AUD button to end the control mode.

NOTE

- Determining the parameters in the audio control setting would clear all the adjustments made in the System Q and they are replaced with the values in the audio control setting.
- The following parameters can be set when the System Q function on the menu settings is ON.
Bass center frequency, bass quality factor, bass extend, middle center frequency, middle quality factor, and treble center frequency.

Function of the KDC-X617

Bass Center Frequency

Adjust the center frequency of the bass.

Display and setting:

"Bass F" : 60 / 70 / 80 / 100 (Only when the bass quality factor is set to 1.00, 1.25 or 1.50) / 150 (Only when the bass quality factor is set to 2.00) Hz.

Bass Level

Adjust the bass level.

Display and setting:

"Bass" : - 8 - + 8

Function of the KDC-X617

Bass Quality Factor

Adjust the Bass quality factor.

Display and setting:

"Bass Q" : 1.00 / 1.25 / 1.50 / 2.00

Function of the KDC-X617

Bass Extend

Switch the Bass Extend mode on/off.

Display and setting:

"Bass EXT" : ON / OFF (When the bass extend mode is set to on, low frequency response is extended by 20%.)

Audio control features

Function of the KDC-X617

Middle Center Frequency

Adjust the center frequency of the middle.

Display and setting:

"MID F" : 0.5 / 1.0 / 1.5 / 2.0 kHz.

Middle Level

Adjust the middle level.

Display and setting:

"Middle"/"MID" : - 8 – + 8

Function of the KDC-X617

Middle Quality Factor

Adjust the middle quality factor.

Display and setting:

"Middle Q" : 1.0 / 2.0

Function of the KDC-X617

Treble Center Frequency

Adjust the center frequency of the treble.

Display and setting:

"TRE F" : 10.0 / 12.5 / 15.0 / 17.5 kHz

Treble Level

Adjust the treble level.

Display and setting:

"Treble"/"TRE" : - 8 – + 8

Balance Level

Adjust the balance level.

Display and setting:

"Balance" : Left 15 – Right 15

Fader Level

Adjust the fader level.

Display and setting:

"Fader" : Rear 15 – Front 15

Function of the KDC-X617

Non-Fading Level

Adjust the Non-fading output level.

Display and setting:

"NF Level" : - 15 – + 15

Function of the KDC-X617

High-pass Filter Frequency for Front Output

Adjust the frequency of the High-pass filter for front output.

Display and setting:

"HPF F" : Through / 40Hz / 60Hz / 80Hz / 100Hz / 120Hz /
150Hz / 180Hz / 220Hz

NOTE

You can separately set the high-pass filter for front and rear output, including preouts. The high-pass filter does not affect the non-fading preout.

Function of the KDC-X617

High-pass Filter Frequency for Rear Output

Adjust the frequency of the High-pass filter for rear output.

Display and setting:

"HPF R" : Through / 40Hz / 60Hz / 80Hz / 100Hz / 120Hz /
150Hz / 180Hz / 220Hz

NOTE

You can separately set the high-pass filter for front and rear output, including preouts. The high-pass filter does not affect the non-fading preout.

Function of the KDC-X617

Low-pass Filter Frequency for Non-Fading Output

Adjust the frequency of the Low-pass filter for Non-Fading output.

Display and setting:

"LPF NF" : 50 Hz / 80 Hz / 120 Hz / Through

Function of the KDC-X617

Phase for Non-Fading Output

Adjust the phase for Non-Fading output.

Display and setting:

"NF Phase" : Normal (0°) / Reverse (180°)

Volume Offset

Set the sound level of the each source selected by adjusting the level difference between the basic sound level and the required level.

Display and setting:

"V Offset"/"VOL Offset" : - 8 – ± 0

Tuner features

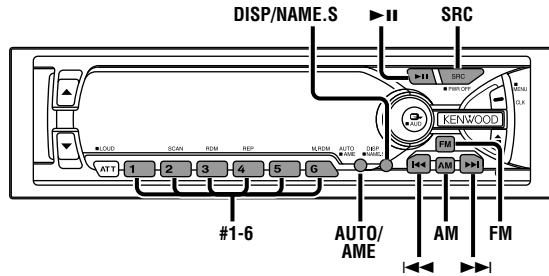

KDC-X617/KDC-516S/KDC-57MR

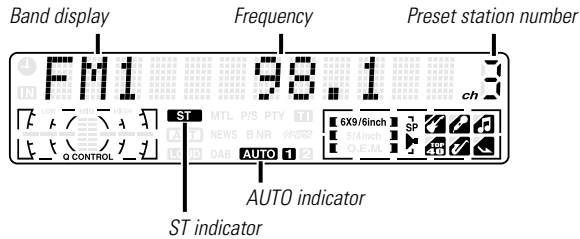

KDC-V6017

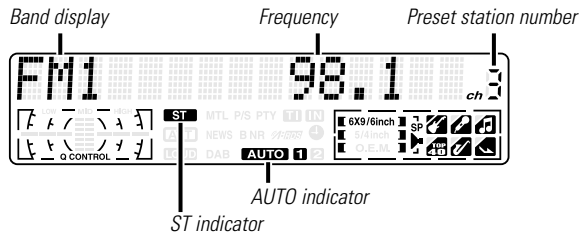

Tuning

You can choose from three tuning modes: auto seek, preset station seek, and manual. The AUTO 1 indicator lights up when auto seek tuning is selected, and the AUTO 2 indicator lights when preset station seek tuning is selected.

Selecting Tuning Mode:

Press the AUTO button.

Each time you press the AUTO button, the mode switches as follows.

- ↓
- Auto 1 (Auto Seek Tuning)
- ↓
- Auto 2 (Preset Station Seek Tuning)
- ↓
- Manual (Manual Tuning)

Tuning:

- 1 Press the SRC (source) button repeatedly to select the tuner mode. "TUNER" is displayed when the tuner mode has been selected.
- 2 Press either the FM or AM button to select the band. Each time you press the FM button, the band switches between the FM1, FM2 and FM3 (which are used for groups of preset stations). Press the AM button to select the AM band.
- 3
 - Auto Seek Tuning
 - Press the ►► button to seek higher frequencies.
 - Press the ◀◀ button to seek lower frequencies.
 - Preset station seek tuning
 - Press the ►► button to move to the next preset station (i.e., the one with the next highest number), and the ◀◀ button to move to the last preset station (i.e., the one with the next lowest number).
 - Manual Tuning
 - Press the ►► button to increase the frequency by one step.
 - Press the ◀◀ button to decrease the frequency by one step.

NOTE

The ST indicator lights up when stereo broadcasts are being

received.

Direct Access Tuning *(Function of remote)*

When you know the frequency of the station that you want to listen to, you can input it directly for quick access.

- 1 Select the band by pressing the FM or AM button.
- 2 Press the DIRECT button.
"----" is displayed for 10 seconds.
If you make no input in the 10-second period, direct access tuning is automatically canceled.
- 3 Enter the frequency of the desired station.
If you want to listen to an FM station at 92.1 MHz, for example, press 0, 9, 2, and 1.
If you want to listen to an AM station at 810 kHz, for example, press 0, 8, 1, and 0.

NOTE

- You cannot enter frequencies above or below what a band can receive.
- FM frequencies can only be input in 0.1 MHz steps, and not 0.01 MHz steps.

Canceling Direct Access Tuning:

Press the DIRECT button again.

Station Preset Memory

Store the frequency of a station. You can then recall that station with a single touch of a button.

- 1 Select the band/station that you want to have stored.
- 2 Press the button (#1-6) that you want to use for the station, for at least two seconds.
The button number blinks once in the display to indicate that the data has been stored.

Recalling a Preset Station:

Press the preset station button (#1-6) for the desired station. The number of the recalled station is displayed.

NOTE

You can store six stations in each of the FM1, FM2, FM3, and AM bands.

Auto Memory Entry

You can automatically store all the receivable frequencies in the band currently being listened to, and then recall them with the touch of a button later. This function is especially useful when you are travelling and do not know what stations are available. Up to six frequencies can be stored this way.

- 1 Select the band for auto memory entry.
- 2 Press the AME button for at least two seconds to start auto memory entry.
The numbers of the preset station buttons are shown in order. When all the stations in a certain band are stored in the preset memory, the auto memory entry stops. The tuner then plays the last station received.

Recalling a Preset Station:

Press the preset station button (#1-6) for the desired station. The number of the recalled station is displayed.

Tuner features

Station Name Preset (SNPS)

You can assign names to radio stations with the Station Preset Memory. Up to 32 FM stations and 16 AM stations can be assigned names.

- Adjust the frequency to the station whose name you want to enter.
- Press the NAME.S button for at least two seconds. "NAME SET" is displayed once the station name preset mode is entered. The cursor will blink in the position where letters are entered.
- Press either the ◀◀ or ▶▶ button to move the cursor to the desired position. The ◀◀ button moves the cursor to the left, and the ▶▶ button to the right. You can also move the cursor left or right by pressing the ◀◀ or ▶▶ buttons, respectively, on the remote.
- Each time the ▶▶ button is pressed, the characters to be entered change as listed below. Press the FM or AM button to display the desired character. Characters that can be displayed are as follows.

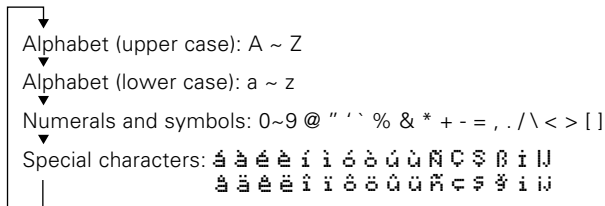

NOTE Direct Alphabet Input

(Function of remote with number/letter entry buttons)

Direct input can be made of letters (alphabetical) with the letter entry buttons on the remote.

Example: Use the following table to enter the name "DANCE".

Character	Button to press	# Times pressed
"D"	#3	1
"A"	#2	1
"N"	#6	2
"C"	#2	3
"E"	#3	2

- Continue steps 3 and 4 until all the characters are chosen for the name.

NOTE

You can enter up to eight characters for each name.

6 Assigning Names

Press the NAME.S button on the unit or the OK button on the remote.

The name of the station is stored in memory, and the Station Name Preset mode ends.

Also, if you make no input for 10 seconds, the name will be stored up to the point that you have entered, and the mode ends.

NOTE

- You can assign names to up to 32 FM stations and 16 AM stations.
- All the station names will be erased if you press the Reset button.
- If you want to change the name of a station, first display the name of the station (following steps 1 and 2 above), then change the letter(s) that you want by following steps 3 and 4.

Switching Display for Tuner

You can change the display used when listening to the radio.

Changing the Display:

Each time you press the DISP button, the display changes as

follows:

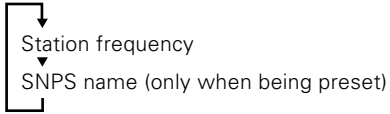

CD/External disc control features

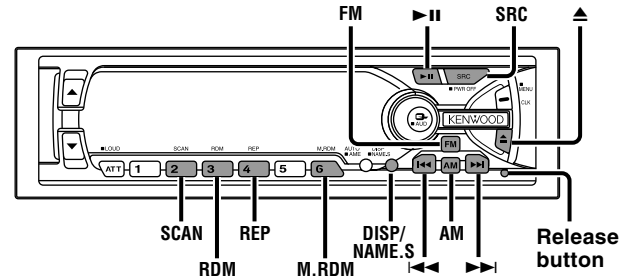

KDC-X617/KDC-516S/KDC-57MR

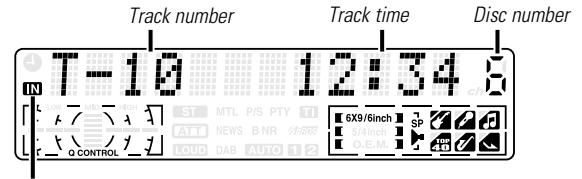

IN indicator

KDC-V6017

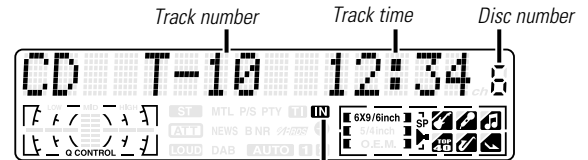

IN indicator

CD/External disc control features

Playing CDs

Playing CDs:

Press the release button to slide open the faceplate, showing the CD insertion slot.

Holding the CD with the labeled side facing up, insert it in the slot. The CD will start playing. Push back the bottom of the faceplate with your hand until it locks.

The IN indicator will light when a CD has been inserted.

▲CAUTION

When inserting a CD, make sure the CD has been completely drawn in before pushing back the faceplate. Failing to do so might scratch the CD.

Playing CDs Already Inserted:

Press the SRC (source) button repeatedly to select the CD mode.

"CD" is displayed when the CD mode has been selected.

The CD will start playing.

Pausing and Restarting CD Play:

Press the ►|| button to make the disc pause.

Press the same button again to start play again.

Eject:

Press the release button and slide open the faceplate.

Press the ▲ button.

The CD stops playing and ejects from the slot.

Push back the bottom of the faceplate with your hand until it locks.

▲CAUTION

- Do not attempt to insert a CD into the slot if another one is already there.
- The unit can only play 5 in. CDs. If you insert a 3 in. CD, it will get stuck inside and can cause the unit to malfunction.
- When the faceplate has been slid open, it might interfere with the shift lever or something else. If this happens, pay attention to safety and move the shift lever or take an appropriate action, then operate the unit.
- Do not use the unit with the faceplate in the open condition. Doing so will cause breakdown.

NOTE

- When you load a CD and eject it right away, the next time you try to insert the CD may not load. In such a situation, take the CD out for a moment and then reinsert it.
- While the control panel is sliding, only available buttons are ▲, ATT, ▲, ▼ and SRC.

Playing Other Disc mode

This function permits the connection of optional players and the playing of discs other than the loaded CD (in the current unit).

Playing Discs:

Press the SRC button repeatedly to select the external disc control mode.

The disc will start playing.

NOTE

The external disc control mode will differ, depending on the unit that is connected.

Mode Display Examples

- "CD2" ...when a CD player is connected
- "DISC" ...when a disc changer is connected
- "DISC-1" , "DISC-2" ...when two disc changers are connected

Pausing and Restarting Disc Play:

Press the ►|| button to make the disc pause.

Press the same button again to start play again.

NOTE

- When one disc has finished playing its last track, the next disc in the changer will start playing. When the last disc in the changer has finished, the player will return to the first disc and start playing it.
- Disc #10 is displayed as "0".

Switching Display for Discs

Switch the display that appears while discs are playing.

Switching Display for Discs:

Each time you press the DISP button, the display during disc play switches as follows:

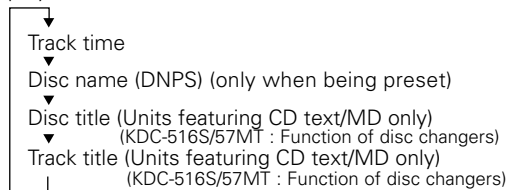

NOTE

- You can give names to discs through the presetting disc name function (page 24). Note that depending on the unit, display may not be possible.
- If you try to display the name of a disc that does not have one, "NO NAME" is displayed instead.
- When there is an attempt to display the title of a disc for which the disc title/track title has not been recorded, "NO TEXT" is displayed for CD and "NO TITLE/NO NAME" is displayed for MD.
- If you attempt to display disc title/track title when connecting the CD changer not supported for CD text feature, caution messages such as "NO TEXT" or "Reading" may be displayed.
- Depending on the type of characters of the CD Text, some characters may not be displayable.

Fast Forwarding and Reversing Disc Play

Fast Forwarding Disc Play:

Hold down on the ►►► button.

Release your finger to play the disc at that point.

Reversing Disc Play:

Hold down on the ◀◀◀ button.

Release your finger to play the disc at the point.

NOTE

You cannot use reverse play between tracks depending on the model being connected. Instead, the reverse play function is canceled when it reaches the beginning of a track, at which point normal play will automatically resume.

Track Search

Search forward or backward through the tracks on the disc until you reach the one that you want to listen to.

Making a Reverse Track Search:

Press the ◀◀◀ button to display the desired track number.

Press once to search back to the beginning of the current track, twice to search back to the beginning of the previous track, and so forth.

Play starts at the beginning of the displayed track number.

NOTE (For disc changers)

Pressing the ◀◀◀ button while listening to track 1 will only search back to the beginning of that track. The reverse search is not "recycled" to the last track on the disc.

Making a Forward Track Search:

Press the ►►► button to display the desired track number.

Press once to fast forward to the next track, twice to fast forward to the track after that, and so forth.

Play starts at the beginning of the displayed track number.

NOTE (For disc changers)

You cannot make a forward track search when listening to the last track on a disc.

CD/External disc control features

Disc Search

(Function of disc changers)

Search forward or backward through the discs in a disc changer.

Making a Reverse Disc Search:

Press the AM button to display the desired disc number. Each time the button is pressed, the displayed disc number decreases by one. Play starts at the beginning of the displayed disc.

Making a Forward Disc Search:

Press the FM button to display the desired disc number. Each time the button is pressed, the displayed disc number increases by one. Play starts at the beginning of the displayed disc.

NOTE

"Load" is displayed when discs are being exchanged on the disc changer.

Track / Disc Repeat

Repeat playing the track or the disc currently being listened to.

Turning Repeat Play On/Off:

Press the REP button to switch repeat track/disc play on and off as follows:

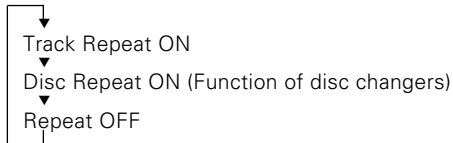

"Repeat ON"/"T-Repeat ON" is displayed and the track number blinks in the display when track repeat is on.

"Disc Repeat ON"/"D-Repeat ON" is displayed and the disc number blinks in the display when disc repeat is on.

NOTE

Repeat play is canceled when you eject the disc.

Track Scan

Successively play the beginning of each track on a disc until you find the track that you want to listen to.

Starting the Track Scan:

Press the SCAN button. "Scan ON" is displayed and the first 10 seconds of each track will be played, in order. The track number currently being heard blinks in the display.

Stopping to Listen to the Track Being Scanned:

Press the ►|| or SCAN button again to stop the scan and keep on listening to a track normally.

NOTE

- The track scan function is canceled when you eject the disc.
- The track scan function only scans each track on a disc once.

Random Play

Play all the tracks on the current disc in random order.

- 1 Press the RDM button to switch random play on and off. "Random ON" is displayed when random play is turned on. The track number will change over and over in the display as the next track is being selected. When the track has been selected, play will begin. The selected track number blinks in the display as it is being played.

NOTE (For disc changers)

When all the tracks on a certain disc have been played using random play, the next disc on the changer will start playing using the same function.

- 2 To change the track being heard, press the ►| button. Another track will be selected and played.

NOTE

Random play is canceled when you eject the disc.

Magazine Random Play *(Function of disc changers)*

Play the tracks on all the discs in the disc changer in random order.

- 1 Press the M.RDM button to switch magazine random play on and off.
"M.Random ON" is displayed when magazine random play is turned on.
The disc and track numbers will change over and over in the display as the next track is being selected.
When the disc/track has been selected, play will begin.
The selected disc/track number blinks in the display as it is being played.
- 2 To change the track being heard, press the ►► button.
Another disc/track will be selected and played.

NOTE

- Magazine random play is canceled when you eject the disc.
- The time needed for random selection depends on the number of discs loaded in the disc magazine.

Text / Title Scroll

This function permits the text to be scrolled and the entire text to be displayed. The scrolling method differs depending on the setting of scrolling in the menu.

To scroll automatically:

Press the DISP button to display the disc title or the track title.
The display of the text will be scrolled repeatedly.

To scroll manually:

- 1 Press the DISP button to display the disc title or the track title.

- 2 Pressing the DISP button for at least one second results in one scrolling display of the titles.

NOTE

- Please see the menu settings (page 31) about switching between manual scrolling and automatic scrolling.
- Only units with a CD text feature permit title display.
- You cannot be the text scroll function while magazine random play.

CD/External disc control features

Presetting Disc Names (DNPS)

Store the names of discs to be displayed when played.

- 1 Play the disc whose name you want to preset.

NOTE

- This function is not available for disc changers that do not feature the Disc Name Preset function.
- The Disc Name Preset function cannot be used during the Magazine random play as well as while a disc title or track title is displayed.

- 2 Press the NAME.S button for at least two seconds. "NAME SET" is displayed and the disc name preset mode is entered. The cursor blinks in the position where character input can be made.

- 3 Press either the ◀◀ or ▶▶ button to move the cursor to the desired position. The ◀◀ button moves the cursor to the left, and the ▶▶ button to the right. You can also move the cursor left or right by pressing the ◀◀ or ▶▶ buttons, respectively, on the remote.

- 4 Each press of the ▶▶ button results in the type of characters that are to be entered changing between alphabet and numerals/symbols. Press the FM or AM button to display the desired character. Characters that can be displayed are as follows.

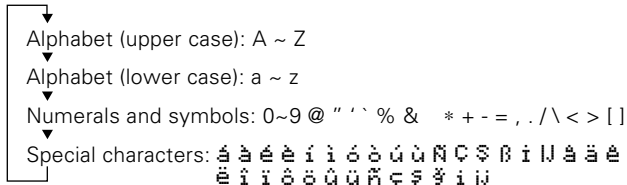

NOTE Direct Alphabet Input

(Function of remote with number/letter entry buttons)

If the disc changers that were manufactured and sold after 1997

(except for KDC-C560) are connected, you can directly input letters using the number/letter entry buttons on the remote. Example: Use the following table to enter the name "DANCE".

Character	Button to press	# Times pressed
"D"	#3	1
"A"	#2	1
"N"	#6	2
"C"	#2	3
"E"	#3	2

- 5 Continue steps 3 and 4 until all the characters are chosen for the name.

NOTE

You can enter up to 12 characters for each name.

- 6 Press either the NAME.S button on the main unit or the OK button on the remote. The disc name is stored and the disc name preset mode is canceled. If you make no entry in a 10-second period, the name will be stored with the characters input so far.

NOTE

- The number of discs whose names can be stored will differ depending on the disc changer that is connected. Please see your disc changer manual for details. Up to 30 CDs can be registered with this unit.
- Discs are identified by their total length and number of tracks. If another disc happens to have the same specifications as one that you have already stored a name for, the name will be displayed for it, too.
- If you want to change the name of a disc, repeat steps 1 and 2 to display the name, and then repeat steps 3 and 4 to input the changes.
- Pressing the reset button erases the disc names stored in this unit, but does not erase the names stored in a disc changer.

Disc Name Preset Play (DNPP)

(Function of Remote)

If you have preset the name of a disc that you want to listen to in the disc changer, you can look for it by name and start playing it.

- 1 Press the DNPP button on the remote.
"DNPP" will appear in the display, and the disc name preset play mode is entered.
The preset names/disc titles of the disc in the disc changer to which you are currently listening are successively displayed for five seconds each.
In any of the units that are connected, discs that have not been disc name preset will display "NO NAME".

NOTE

- This function can only be used in disc changers that were manufactured or sold as of 1997. Also note that some units cannot provide a display unless the disc name preset has been made by the unit that is playing.
- Discs in the disc changer that have never been played before will appear as "NO ACCESS" when the disc names are displayed. When you cannot identify a disc because of the "NO ACCESS" display after inserting a disc magazine, try playing it to display the disc name. Also note that "NO DISC" will be displayed when a disc has not been loaded.

Rapid display (forward / reverse):

Press the DISC+ or DISC- button.

Pressing the DISC+ button will rapidly display the preset names/disc titles in order.

Pressing the DISC- button will rapidly display the preset names/disc titles in reverse order.

2 When the name appears for the disc you want to play

Press the OK button.

The disc whose name is displayed will be recalled, and the disc name preset play (DNPP) mode will end.

To cancel DNPP mode:

Press the DNPP button.

The disc name preset play (DNPP) mode will be canceled.

Direct Track Search

(Function of Remote)

Using the remote, directly input the track number that you want to listen to.

- 1 Using the number buttons on the remote, input the number of the track that you want to listen to.
The selected track number will blink in the display for 10 seconds.
If you make no further input in the 10-second period, the number entry mode will automatically be canceled.
- 2 Press either the ◀◀ or ▶▶ button while the track number is blinking.
The track starts playing.

Canceling Direct Track Search While It Is Operating:

Press the ▶|| button.

NOTE

You cannot use the direct track search function while doing random or magazine-random play.

CD/External disc control features

Direct Disc Search (Function of disc changers with remote)

Using the remote, directly input the disc number that you want to listen to.

- Using the number buttons on the remote, input the number of the disc that you want to listen to.
The selected disc number will blink in the display for 10 seconds.
If you make no further input in the 10-second period, the number entry mode will automatically be canceled.

NOTE

- Input "0" to select disc 10.
 - If you input more than two numbers all at once, a search will be made only of the last number input.
 - You cannot use the direct disc search function during random play or magazine random play.
- Press either the DISC+ or DISC- button while the number inputted is blinking.
The disc starts playing.

Canceling Direct Disc Search While It Is Operating:

Press the ►|| button.

Menu settings

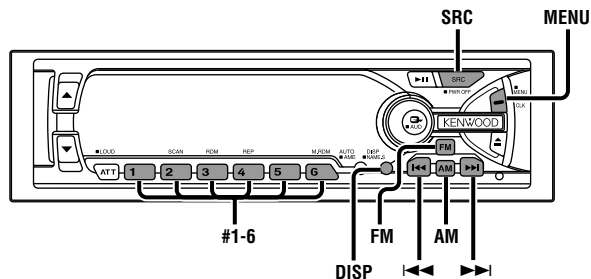

KDC-X617/KDC-516S/KDC-57MR

Menu display



KDC-V6017

Menu display



Menu System

You can set the defaults for additional functions in the menu mode. Make a setting for each function, referring to the following operations.

1 **Enter the menu mode**

Press the MENU button for at least one second.

"MENU" is displayed when the menu mode is entered.

The function that you can adjust is indicated with the current settings displayed.

2 **Selecting function to set**

Press the FM button to search through the functions until you see the one you want to adjust in the display.

Press the AM button to search through the functions backward.

Function items change in the order of features that follow in the menu system.

Example: If you want to switch the setting of the touch sensor tone function from on to off, first search through the functions until you see "Beep ON" in the display.

3 **Changing setting for currently displayed function**

Press either the **◀◀** or **▶▶** button.

The setting will change for each function.

Example: The setting of the touch sensor tone will switch from on to off, and "Beep OFF" is displayed.

4 **Ending the menu mode**

Press the MENU button.

NOTE

Make sure to end the menu mode when finished.

Menu settings

Security Code

When the battery is removed from the unit's power switch, you cannot turn on the unit again unless the preset security code is input. This function helps prevent theft.

NOTE

You must follow steps 1 to 8 to be able to use the Security Code function. Turning off the power during the procedure will deactivate the security code setting.

Once the security code function has been activated, "Security" disappears from the MENU system. Note that it will no longer be possible to cancel this function afterwards.

- 1 Press the SRC button repeatedly to select the standby mode. "ALL OFF" is displayed when the standby mode is selected.
- 2 Select the four digits to use in your security code.

NOTE

The four-digit security code is very important, as you will need it to turn the unit on again when the code security function is on. Choose the number carefully and do not forget it (write it down and keep it separately in a safe place).

- 3 Press the MENU button for at least one second. "MENU" is displayed first and then "Security" is displayed.
- 4 Press either the ◀◀ or ▶▶ button for at least two seconds. "ENTER" will appear in the display for one second, indicating the code setting mode has been entered. When "CODE" appears in the display, you can start inputting the code.
- 5 Press the preset button and enter the security code that you have selected in step 2.
Example: Use "3510" as the security code.

Step	Button to press	# Times pressed	Display
1	#1	4	"3"
2	#2	6	"5"
3	#3	2	"1"
4	#4	1	"0"

- 6 Press the DISP button for at least three seconds. The security code will be set. "RE-ENTER" will appear in the display for one second, asking you to enter the code once again for confirmation. When "CODE" appears in the display, you can start inputting the code.
- 7 Press the Preset button and input the security code again.
- 8 Press the DISP button again for at least three seconds. "APPROVED" will appear in the display, with the security code function turning on. From this point on, if the unit is disconnected from the battery, the security code must be entered the first time that the unit's power is turned on. "ENTER" and "CODE" will appear in the display, asking you to input the code.

NOTE

If you input an incorrect security code, the code setting mode will be canceled automatically. Follow the steps from 4 to 8 above again.

If you press the RESET button or remove the battery:

The first time you turn the unit on again, "CODE" will appear in the display, asking you to input the security code. Repeat steps 7 and 8 above, and input the security code. You can start operating the unit again when "APPROVED" appears in the display.

If you enter the incorrect code, the power will turn off. Enter the correct code to turn the unit on.

Touch Sensor Tone

This function produces a beep sound that accompanies button operation. It can be switched on or off.

Display and setting:

"Beep ON" : Beep setting is on. (Default setting)

"Beep OFF" : Beep setting is off.

NOTE

The beep sound is not output from the preout jacks.

Manual Time Adjustment

Adjust the time manually.

Display and setting:

- 1 Select the display "Clock Adjust" during the selecting function in the menu system.
- 2 Press either the **◀◀** or **▶▶** button for at least one second to enter the Manual time adjustment mode.
The time display will blink.
- 3 • Adjusting the hours
Press the FM button to advance the hours, or press the AM button to make the hours go back.
• Adjusting the minutes
Press the **▶▶** button to advance the minutes, or press the **◀◀** button to make the minutes go back.
- 4 Press the MENU button to end the Manual Time Adjustment mode.
Exiting the Manual Time Adjustment mode would start the clock counting.

Selectable Illumination

You can switch the color of the button illumination between green and red.

Display and setting:

"Button Green" : The color of the illumination is green.

"Button Red" : The color of the illumination is red.

Switching Graphic Display

This function allows you to turn off the lower part of the display if there is too much information in the display.

Display and setting:

- "Graphic ON" : The display will turn on by using the whole part of the display. (Default setting)
- "Graphic OFF" : The display will turn on by using only the upper part of the display and the IN indicator.

Menu settings

Function of the KDC-V6017

Variable Illumination Color Setting

You can set the display to a desired color.

Display and setting:

1 Select the display "Color" during the selecting function in the menu mode.

2 To set a color manually:

Hold down on the ◀◀ or ▶▶ button.

Pressing the ▶▶ button advances the color, and pressing the ◀◀ button reverses it.

When the desirable color appears, release the button.

3 To make the popular colors appear:

Press the preset button (#1-4) for the desired color.

The buttons #1-4 is preset for the following four colors:

#1: White

#2: Red

#3: Blue

#4: Blue Green

4 To switch colors depending on the situation: (Situational Mode)

Each time you press the #6 button, the mode switches as follows:

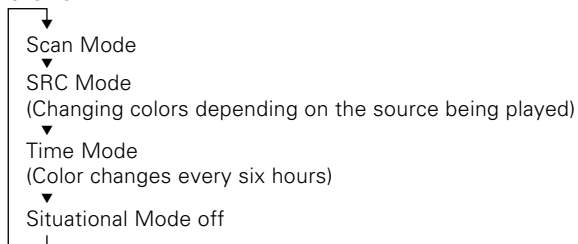

When Situational Mode is off, the original color setting resumes.

5 To finely adjust blue: (Blue Adjust Mode)

Press the #3 button for at least two seconds to enter the

blue adjust mode.

The ◀◀ and ▶▶ buttons are used to adjust the blue color tones, respectively.

Press the #3 button to end the blue adjust mode.

6 To store the color setting in the memory: (color preset memory)

After adjusting the illumination colors, press the #5 button for two seconds to store the color setting in the memory.

Pressing the #5 button again recalls the stored colors from the memory.

NOTE

The Blue Adjust mode setting cannot be stored in memory.

7 Press the MENU button to end the Variable Illumination Color Setting mode.

Contrast Adjustment

This adjustment permits easy viewing of the display.

Display and setting:

"Contrast 0" – "Contrast 10"

NOTE

The initial setting value is "5".

Dimmer

You can dim the display.

NOTE

The dimmer function is not available for units if the dimmer wire is not connected.

Display and setting:

"Dimmer ON" : The dimmer setting is on. (Default setting)

"Dimmer OFF" : The dimmer setting is off.

Function of the KDC-X617

System Q

When this system is set to on, the System Q factors (Bass center frequency, Bass quality factor, Bass extend, Middle center frequency, Middle quality factor, and Treble center frequency) appear during the audio control mode.

Display and setting:

"System Q ON" : The System Q factors appear and can be adjusted. (Default setting)

"System Q OFF" : The System Q factors are not appeared.

Function of the KDC-X617

External Amp Control

Adjust the bass boost level of the external amplifier using the main unit.

Display and setting:

"AMP Bass FLT" : Bass boost level is flat. (Default setting)

"AMP Bass +6" : Bass boost level is low (+6dB).

"AMP Bass +12" : Bass boost level is high (+12dB).

NOTE

As of December 2000, the power amplifiers controllable by the main unit are as follows:
KAC-X501F/PS501F/X401M/PS401M/X301T/PS301T/X201T/PS201T

Clean Reception System Circuit (CRSC) <In FM reception of Tuner mode>

Temporarily have reception switched from stereo to mono to reduce multi-path noise when listening to the FM station.

Display and setting:

"CRSC ON" : The CRSC is on. (Default setting)

"CRSC OFF" : The CRSC is off.

NOTE

Strong electrical fields (such as from power lines) may cause unstable sound quality when CRSC is turned on. In such a situation, turn it off.

Text Scroll <In External disc control mode>

This function permits the CD text and MD title to be scrolled and the entire text to be displayed. Switching between manual scrolling and automatic scrolling is permitted.

Display and setting:

"Scroll Auto" : Automatic scrolling (Default setting)

"Scroll MANU"/"Scroll Manual" : Manual scrolling

Basic Operations of remote

Accessory of the KDC-X617/KDC-V6017

KDC-X617

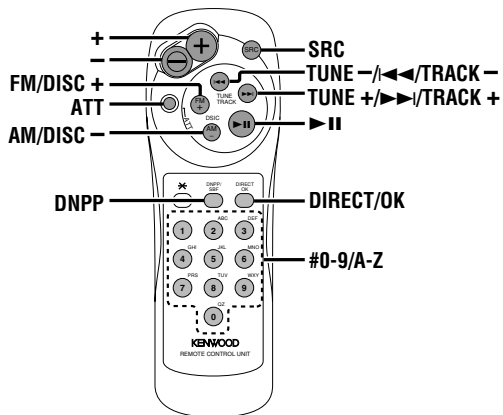

KDC-V6017

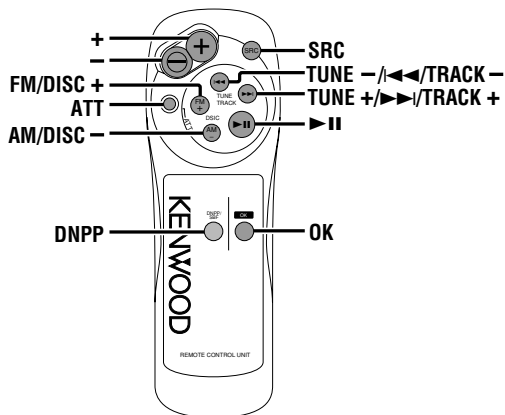

▲CAUTION

Do not set the remote on hot places such as above the dashboard.

Loading and Replacing the Batteries:

Use two "AAA"-size batteries.

Slide the cover while pressing downwards to remove it as illustrated.

Insert the batteries with the + and - poles aligned properly, following the illustration inside the case.

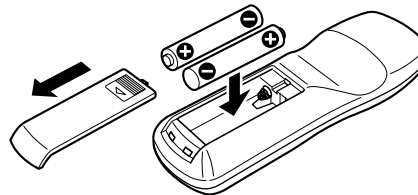

▲WARNING

Store unused batteries out of the reach of children. Contact a doctor immediately if the battery is accidentally swallowed.

NOTE

- The provided batteries are intended for use in operation checking, and their service life may be short.
- When the remote controllable distance becomes short, replace both of the batteries with new ones.
- A portion of the operations may not be possible, depending on the unit that is connected.

Basic operations

• VOLUME buttons

Press the **+** button to turn the volume up.
Press the **-** button to turn the volume down.

• SRC button

Each time you press the SRC button, the mode switches as follows:

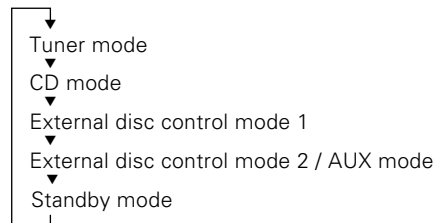

NOTE

- The mode switches to the next mode from any mode which cannot be used.
- The external disc control mode will differ depending on the unit that is connected.
- To enable the selection of External disc control mode 2/AUX mode, you should connect optional switching adapter KCA-S210A (which allows you to select both External disc control mode 2 and AUX mode) or CD changer (KDC-CPS87, KDC-CX87, KDC-CPS85, KDC-CX85, KDC-CPS82 or KDC-CX82) or switching adapter CA-C1AX (which allows you to select AUX mode only).
During the AUX mode, "AUX" (or AUX-name display) will show in the display.
When the CA-C1AX is being used, the AUX Mode will replace the External Disc Control Mode.
- **ATT button**
Turns down the volume quickly. To return the volume to its original level, press the button again. Turning the volume up, or turning it all the way down deactivates the attenuator function.

Tuner features

• ◀◀/▶▶ (TUNE) buttons

Press the **◀◀** button to make decreasing seeks (using the preset tuning mode).
Press the **▶▶** button to make increasing seeks (using the preset tuning mode).
Use to move the cursor left or right during station name input.

• AM/FM buttons

Press the AM button to select the AM band.
Press the FM button to select and switch between FM1, FM2, and FM3 bands.
During station name input, selects digits and symbols.

• DIRECT/OK button

During station name input, stores the already input data in memory and ends the input mode.
Enters and cancels the Direct access tuning mode.

• ▶|| button

Selects the type of characters at the time of entering the station name.

• Number/letter entry buttons (KDC-X617 only)

Press buttons #1-6 to recall preset stations.
Use to enter letters (alphabetical) during station name preset.
Use to enter frequency of the desired station during Direct access tuning mode.





Basic Operations of remote

Accessory of the KDC-X617/KDC-V6017

CD/External disc control features

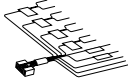
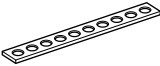
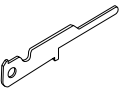
- **◀◀/▶▶ buttons**
Press the ◀◀ button to search through the tracks backward.
Press the ▶▶ button to search through the tracks forward.
Use to move the cursor while entering disc name.
- **DISC buttons (for disc changers)**
Press the DISC- button to search through the discs backward.
Press the DISC+ button to search through the discs forward.
Select numbers and symbols while entering disc name.
- **▶|| button**
When a disc is playing, this button pauses the play.
Press the same button again to start play again.
Selects the type of characters at the time of entering the disc name.
- **OK button**
During disc name input, stores the already input data in memory and ends the input mode.
Selects disc during the disc name preset play mode.
- **DNPP button (for disc changers)**
Enters and cancels the Disc Name Preset Play mode.
- **Number/letter entry buttons (KDC-X617 only)**
Used to specify the track (disc) number used in direct track (disc) searches.
Use to enter letters during disc name preset.

Accessories

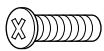
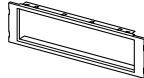
	External view	Number of items
①	1
②	1
③	2
④	4
⑤	4
⑥	1
⑦	1
⑧	1

▲CAUTION

The use of any accessories except for those provided might result in damage to the unit. Make sure only to use the accessories shipped with the unit, as shown above.

Installation Procedure

1. To prevent a short circuit, remove the key from the ignition and disconnect the ⊖ battery.
2. Make the proper input and output wire connections for each unit.
3. Connect the speaker wires of the wiring harness.
4. Connect the wiring harness wires in the following order: ground, battery, ignition.
5. Connect the wiring harness connector to the unit.
6. Install the unit in your car.
7. Reconnect the ⊖ battery.
8. Press the reset button.

▲CAUTION

- If your car's ignition does not have an ACC position, connect the ignition wires to a power source that can be turned on and off with the ignition key. If you connect the ignition wire to a power source with a constant voltage supply, as with battery wires, the battery may die.
- If the console has a lid, make sure to install the unit so that the faceplate will not hit the lid when closing and opening.
- If the fuse blows, first make sure the wires aren't touching to cause a short circuit, then replace the old fuse with one with the same rating.
- Do not let unconnected wires or terminals touch metal on the car or anything else conducting electricity. To prevent a short circuit, do not remove the caps on the ends of the unconnected wires or the terminals.
- Connect the speaker wires correctly to the terminals to which they correspond. The unit may be damaged or fail to work if you share the ⊖ wires or ground them to any metal part in the car.
- After the unit is installed, check whether the brake lamps, blinkers, wipers, etc. on the car are working properly.
- Insulate unconnected wires with vinyl tape or other similar material.
- Some disc changers need conversion cords for connection. See the section on "Safety Precautions" for details.
- Mount the unit so that the mounting angle is 30° or less.

Connecting Wires to Terminals

⚠ WARNING

If you connect the ignition wire (red) and the battery wire (yellow) to the car chassis (ground), you may cause a short circuit, that in turn may start a fire. Always connect those wires to the power source running through the fuse box.

⚠ CAUTION

When only two speakers are being connected to the system, connect the connectors either to both the front output terminals or to both the rear output terminals (do not mix front and rear). For example, if you connect the ⊕ connector of the left speaker to a front output terminal, do not connect the - connector to a rear output terminal.

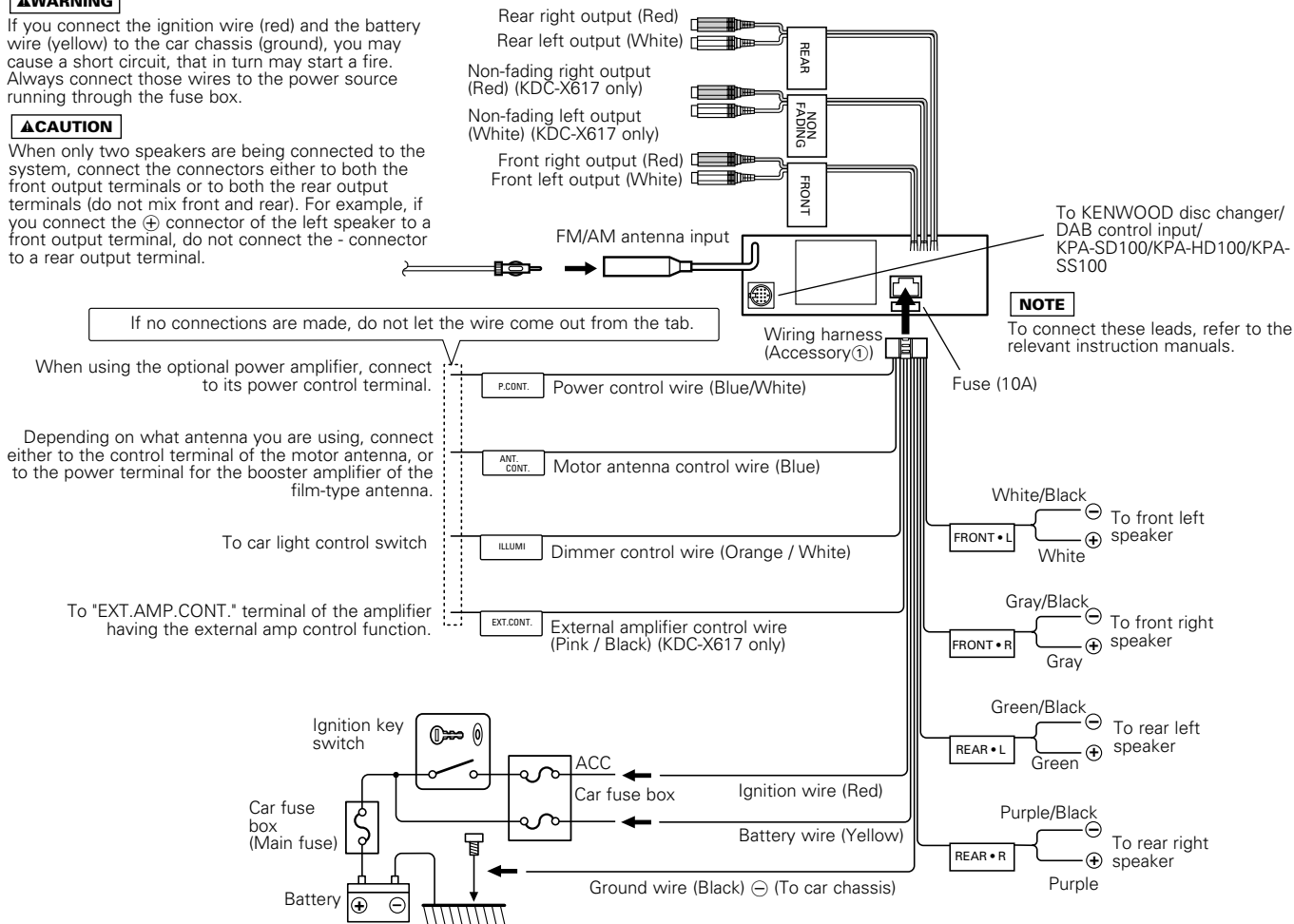

■ Installation

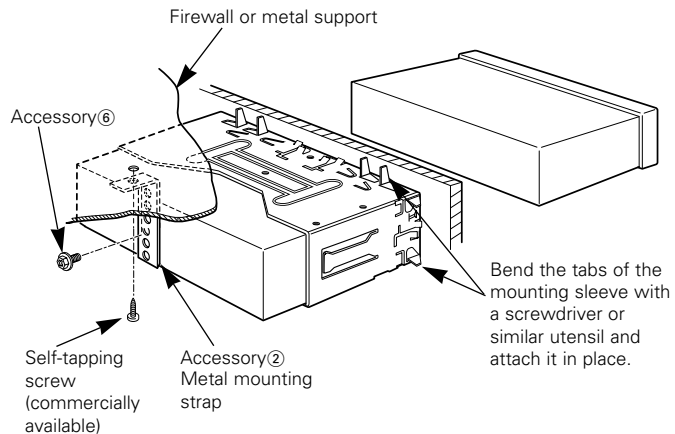

NOTE

Make sure that the unit is installed securely in place. If the unit is unstable, it may malfunction (for example, the sound may skip).

■ Installing in Japanese-Made Cars

- 1 Refer to the section "Removing the hard rubber frame (P. 38)" and then remove the hard rubber frame.
- 2 Mount the J-Car trim plate with the thick part at the bottom.
- 3 Align the holes in the unit (two locations on each side) with the vehicle mounting bracket and secure the unit with the accessory screws.

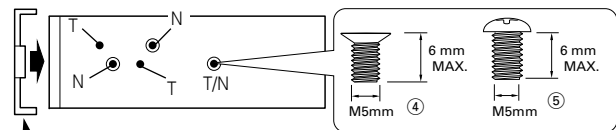

T: Toyota cars
N: Nissan cars

Accessory④...for Nissan car
Accessory⑤...for Toyota car

Accessory⑧
J-Car Trim Plate
(place thick part on bottom)

▲CAUTION

- During installation, do not use any screws except for those provided. The use of different screws might result in damage to the main unit.
- Damage may occur if a screwdriver or similar tool is used with excessive force during the installations.

■ Removing the hard rubber frame

- 1 Refer to the section "Theft deterrent faceplate (P. 10)" and then remove the faceplate.
- 2 Engage the catch pins on the removal tool and remove the two locks on the upper level. Push upward the frame and pull it forward as shown in the figure.

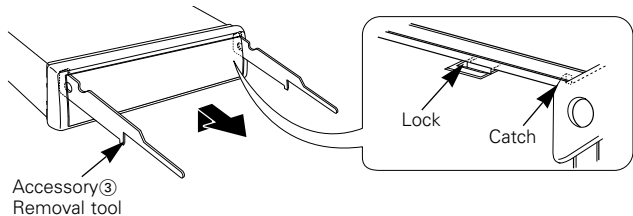

- 3 When the upper level is removed, remove the lower two locations.

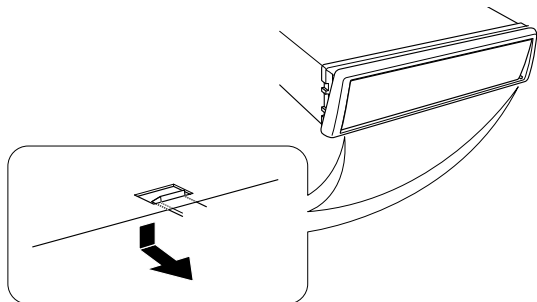

NOTE

The frame can be removed from the bottom side in the same manner.

■ Removing the Unit

- 1 Refer to the section "Removing the hard rubber frame" and then remove the hard rubber frame.
- 2 Remove the Hex-head screw with integral washer (M4x8) on the back panel.
- 3 Insert the two removal tools deeply into the slots on each side, as shown.

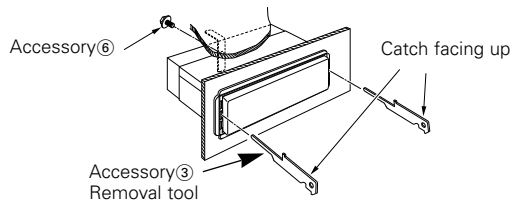

- 4 Push upward the removal tool toward the top, and pull out the unit halfway whilst pressing towards the inside.

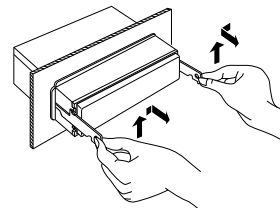

CAUTION

Be careful to avoid injury from the catch pins on the removal tool.

- 5 Pull the unit all the way out with your hands, being careful not to drop it.

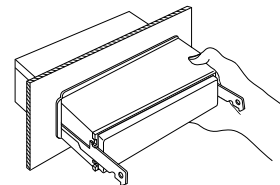

■ Locking the faceplate to the unit

If you want to lock the faceplate to the unit so that it does not fall off, follow the directions below.

- 1 Refer to the function "Theft Deterrent Faceplate" (page 10) and remove the faceplate.
- 2 Insert the provided screw into the hole at the center of the bottom side of the faceplate which you have removed from the unit.

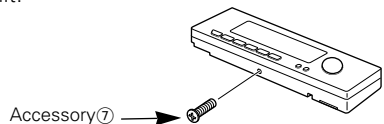

- 3 Push back the bottom of the faceplate bracket unit it locks.
- 4 Refer to the section "Theft Deterrent Faceplate (page 10)" and then reattaching the faceplate.

▲CAUTION

Never insert the taptite screws ($\varnothing 2 \times 4$ mm) in any other screw holes than the one specified. If you insert it in another hole, it will contract and may cause damage to the mechanical parts inside the unit.

Troubleshooting Guide

What might seem to be a malfunction in your unit may just be the result of slight misoperation or miswiring. Before calling service, first check the following table for possible problems.

PROBLEM	POSSIBLE CAUSE	SOLUTION
The power does not turn on.	The fuse has blown.	After checking for short circuits in the wires, replace the fuse with one with the same rating.
No sound can be heard, or the volume is low.	Attenuator is turned on.	Turn off Attenuator.
	The fader or balance settings are set all the way to one side.	Reset the fader or balance settings.
	The input/output wires or wiring harness are connected incorrectly.	Reconnect the input/output wires or the wiring harness correctly. See the section on "Connecting Wires to Terminals".
	The values of Volume offset are low.	Increase the values of Volume offset. (see p. 15)
Nothing happens when the buttons are pressed.	The computer chip in the unit is not functioning normally.	Press the reset button on the unit (see p. 5).
The sound quality is poor or distorted.	One of the speaker wires is being pinched by a screw in the car.	Check the speaker wiring.
	The speakers are not wired correctly.	Reconnect the speaker wires so that each output terminal is connected to a different speaker.
Radio reception is poor.	The car antenna is not extended.	Pull the antenna out all the way.
	The antenna control wire is not connected.	Connect the wire correctly, referring to the section on "Connecting Wires to Terminals".
The memory is erased when the ignition is turned off.	The battery wire has not been connected to the proper terminal.	Connect the wire correctly, referring to the section on "Connecting Wires to Terminals".
	The ignition and battery wire are incorrectly connected.	Connect the wire correctly, referring to the section on "Connecting Wires to Terminals".
A CD ejects as soon as it is loaded.	The CD is upside-down.	Load the CD with the labeled side up.
	The CD is quite dirty.	Clean the CD, referring to the section on "Cleaning CDs" (see p. 6).
The sound skips on a CD.	The CD is scratched or dirty.	Clean the CD, referring to the section on "Cleaning CDs" (see p. 6).
A track will not play.	Random play has been selected.	Turn off random play.

PROBLEM	POSSIBLE CAUSE	SOLUTION
Can't remove disc.	The cause is that more than 10 minutes has elapsed since the vehicle ACC switch was turned OFF.	The disc can only be removed within 10 minutes of the ACC switch being turned OFF. If more than 10 minutes has elapsed, turn the ACC switch ON again and press the Eject button.
Free switching of the sound quality.	The system Q function is set on Scan mode.	Refer to the "System Q" page and switch it to a function other than Scan mode. (see p. 11).
Audio control setting cannot be achieved.	The system Q function is set on Scan mode.	Refer to the "System Q" page and switch it to a function other than Scan mode.(see p. 11).

CD/External disc control mode

PROBLEM	POSSIBLE CAUSE	SOLUTION
The disc control mode cannot be selected.	No wire has been connected to the disc changer input terminal on the unit.	Connect the wire to the disc changer input terminal on the unit.
The specified disc does not play, but another one plays instead.	The specified CD is quite dirty.	Clean the CD.
	The CD is upside-down.	Load the CD with the labeled side up.
	The disc is loaded in a different slot from that specified.	Eject the disc magazine and check the number for the specified disc.
	The disc is severely scratched.	Try another disc instead.
The sound skips.	Something is touching the disc changer.	Remove whatever is touching it.
	The CD is scratched or dirty.	If skipping happens at the same place when the car is stopped, something with the CD is wrong. Clean the CD.
The display shows that the changer is being played, but no sound can be heard.	The computer chip in the unit is not functioning normally.	Press the reset button on the unit (see p. 5).
The specified track will not play.	Random play or magazine random play has been selected.	Turn off random play or magazine random play.
Track repeat, disc repeat, track scan, random play, and magazine random play start by themselves.	The setting is not cancelled.	The settings for these functions remain on until the setting to off or the disc ejected, even if the power is turned off or the source changed.
Cannot play CD-R or CD-RW	Finalization processing is not being conducted for CD-R/CD-RW.	Conduct finalization processing with CD recorder.
	A non-compatible CD changer is being used to play the CD-R/CD-RW.	Use a CD changer compatible with CD-R/CD-RW to play.

If the following situations, consult your nearest service center:

- Even though the disc changer is connected, the Disc Changer Mode is not on, with "AUX" showing in the display during the Changer Mode.
- Even though no device (KCA-S210A, CA-C1AX, KDC-CPS87, KDC-CX87, KDC-CPS85, KDC-CX85, KDC-CPS82 or KDC-CX82) is connected, the AUX Mode is entered when switching modes.

The following messages are displayed when certain problems are occurring in your system. Take the recommended actions.

Eject	No disc magazine has been loaded in the changer. The disc magazine is not completely loaded. ⇒ Load the disc magazine properly. No CD in the unit. ⇒ Insert the CD.
No Disc	No disc has been loaded in the disc magazine. ⇒ Load a disc into the disc magazine.
TOC Error	No disc has been loaded in the disc magazine. ⇒ Load a disc into the disc magazine. The CD is quite dirty. The CD is upside-down. The CD is scratched a lot. ⇒ Clean the CD and load it correctly.
Blank DISC	Nothing has been recorded on the MD.
No Tr DISC	No tracks are recorded on the MD, although it has a title.
NO PANEL	The faceplate of the slave unit being connected to this unit has been removed. ⇒ Replace it.
E-77	The unit is malfunctioning for some reason. ⇒ Press the reset button on the unit. If the "E- 77" code does not disappear, consult your nearest service center.
Mecha Error	Something is wrong with the disc magazine. Or the unit is malfunctioning for some reason. ⇒ Check the disc magazine. And then press the reset button on the unit. If the "Mecha Error" code does not disappear, consult your nearest service center.
Hold Error	The protective circuit in the unit activates when the temperature inside the automatic disc changer exceeds 60°C (140°F), stopping all operation. ⇒ Cool down the unit by opening the windows or turning on the air conditioner. As the temperature falls below 60°C (140°F), the disc will start playing again.
IN	If this indicator blinks, the CD player is malfunctioning. ⇒ Eject the CD and try inserting it again. If the CD cannot be ejected, press the eject button and hold it in until the CD is ejected.

Specifications subject to change without notice.

FM tuner section

Frequency range (200 kHz space)	87.9 MHz – 107.9 MHz
Usable sensitivity (S/N = 30dB)	9.3dBf (0.8 μV/75 Ω)
Quieting Sensitivity (S/N = 50dB)	15.2dBf (1.6 μV/75 Ω)
Frequency response (±3 dB)	30 Hz – 15 kHz
Signal to Noise ratio (MONO)	70 dB
Selectivity (±400 kHz)	≥ 80 dB
Stereo separation (1 kHz)	40 dB

AM tuner section

Frequency range (10 kHz space)	530 kHz – 1700 kHz
Usable sensitivity (S/N = 20dB)	28 dBμ (25 μV)

CD player section

Laser diode	GaAlAs (λ=780 nm)
Digital filter (D/A)	8 Times Over Sampling
D/A Converter	1 Bit
Spindle speed	500 – 200 rpm (CLV)
Wow & Flutter	Below Measurable Limit
Frequency response (±1 dB)	10 Hz – 20 kHz
Total harmonic distortion (1 kHz)	0.01 %
Signal to Noise ratio (1 kHz) (KDC-X617)	105 dB
(KDC-V6017/516S/57MR)	93 dB
Dynamic range	93 dB
Channel separation	85 dB

Audio section

Maximum output power	47 W × 4
Full Bandwidth Power (at less than 1% THD)	22 W × 4
Tone action	
Bass :	100 Hz ±10 dB
Middle :	1 kHz ±10 dB
Treble :	10 kHz ±10 dB
Preout level / Load (during disc play)	1800 mV/10 kΩ
Preout impedance	≤ 600 Ω

General

Operating voltage (11 – 16V allowable)	14.4 V
Current consumption	10 A
Installation Size (W x H x D)	182 × 53 × 162 mm
	7-3/16 × 2-1/16 × 6-5/16 in.
Weight	4.0 lbs (1.7 kg)

KENWOOD

NOTE

You cannot preset disc names on a CD where CD text is contained while this unit is controlling a CD changer "KDC-C665", "KDC-C465", "KDC-C662", or "KDC-C462"

REMARQUE

Il n'est pas possible d'attribuer une étiquette à un CD ou un texte de CD est présent lorsque cette unité sert à diriger un changeur de CDs "KDC-C665", "KDC-C465", "KDC-C662", ou "KDC-C462"

ANMERKUNG

Während dieses Gerät einen CD-Wechsler steuert "KDC-C665", "KDC-C465", „KDC-C662“, oder "KDC-C462" können Sie keine Disc-Namen für eine CD, die CD-Text beinhaltet, voreinstellen.

OPMERKING

U kunt geen diskaam voorkiezen voor CD's met CD text terwijl dit toestel een CD-wisselaar bestuurt "KDC-C665", "KDC-C465", "KDC-C662", of "KDC-C462"

NOTA

Non è possibile preimpostare nomi di dischi per un CD contenente testo CD mentre questa unità sta controllando un multiletto CD "KDC-C665", "KDC-C465", "KDC-C662", o "KDC-C462"

NOTA

Mientras esta unidad este controlando un cambiador de CD "KDC-C665", "KDC-C465", "KDC-C662", o "KDC-C462", no se pueden preajustar nombres de discos para un CD que contenga texto CD.

NOTA

Não é possível predefinir nomes de discos para um CD em que exista texto CD enquanto esta unidade estiver a controlar um carregador de CD "KDC-C665", "KDC-C465", "KDC-C662", ou "KDC-C462"

ПРИМЕЧАНИЕ

Вы не можете заранее запрограммировать названия дисков для диска CD, содержащего текст CD, в то время, когда аппарат управляет чейнджером CD "KDC-C665", "KDC-C465", "KDC-C662", или "KDC-C462"

UWAGA

Nie możesz zaprogramować nazw płyt kompaktowych zawierających tekst CD podczas, gdy to urządzenie steruje zmieniaczem płyt "KDC-C665", "KDC-C465", "KDC-C662" lub "KDC-C462"

MEGJEGYZÉS

A lemeznev beállítására nem lehetséges olyan CD-nél, amely tartalmaz CD szöveget, ha a készülék éppen a CD váltót vezérli "KDC-C665", "KDC-C465", "KDC-C662" vagy "KDC-C462"

POZNÁMKA

Jestliže tato jednotka ovládá měnič CD "KDC-C665", "KDC-C465", "KDC-C662" nebo "KDC-C462", nelze uložit jména disků pro ty CD disky, které obsahují CD text.

NAPOMENA

Ne možete unaprijed podesiti naziv CD-a gdje je sadržan CD tekst dok uređaj upravlja CD mjenjačem "KDC-C665", "KDC-C465", "KDC-C662", or "KDC-C462"

OPOMBA

Med upravljanjem naprave s CD izmenjevalnikom ni mogoče prednastaviti imena CD plošče, ki vsebuje CD tekst. "KDC-C665", "KDC-C465", "KDC-C662", ali "KDC-C462"

OBSERVERA

Du kan inte förinställa skivnamn för en CD med CD-text då denna apparat styr en CD-växlare "KDC-C665", "KDC-C465", "KDC-C662" eller "KDC-C462"

HUOM

CD-levyjien nimiä ei voi esiasettaa tämän laitteen ohjatessa CD levynvaihtajaa "KDC-C665", "KDC-C465", "KDC-C662", tai "KDC-C462"

註

當本裝置控制CD換片機(KDC-C665、KDC-C465、KDC-C662或者KDC-C462)時，無法向包含有CD文本的CD預付光盤名稱。

Table of Contents

	Page
U.S.A.	2
Australia	3
Canada	4,5
Military	6,7
Belgique et Grand-duché de Luxembourg	8
Danmark	9
Deutschland	9
Nederland	10
Portugal	10
U.K. & Ireland	11
Österreich	11
Ελλάς	12
España	12
France	13
Italia	13
Suomi	14
Andorra	14
Iceland	14
Malta	14
Norge	15
Schweiz	15
Svizzera	15
Suisse	15
Sverige	15

Dear Customer,

Thank you for purchasing this Kenwood product. As mentioned in the pages of this booklet, our warranty is only valid in the countries listed. If your country is not listed please contact your retailer for information on warranty procedure, or write to:

KENWOOD Corporation Customer Information Center
 3-17-9 Aobadai
 Meguro-ku Tokyo 153-0042 JAPAN

KENWOOD

Warranty Card

Geräte-Typ und Seriennummer
 Identification du produit
 Produkt navn og serie nummer
 Modelo y Número de serie
 Malli ja sarjanumero
 Μοντέλο και αριθμός σειράς
 Modello e numero di matricola
 Modell og serienummer
 Modelo e numero de serie
 Apparat typ & serienummer
 Identificatie van het produkt
 Mólél heiti og raðnumber
 II-Mudell u s-serial number
 Model number & serial number

Stempel und Unterschrift des Händlers
 Revendeur & cachet
 Forhandler
 Distribuidor y sello
 Jälleenmyyjä & leima
 Σφραγίδα εταιρείας
 Timbro del rivenditore
 Forhandlerens navn og stempel
 Agente e carimbo
 Återförsäljare & stämpel
 Dealer & stempel
 Undirritun og stimpill söluaðila
 Timbru tal-beijjiegħ
 Dealer & stamp

Kaufdatum
 Date d'achat
 Købsdato
 Fecha de compra
 Ostopäivä
 Ημερομηνία αγοράς
 Data di acquisto
 Kjøpt dato
 Data de compra
 Inköpsdatum
 Aankoopdatum
 Söludagur
 Id-data ta' meta nxtara
 Purchase date

Name und Anschrift des Käufers
 Nom & adresse du client
 Købers navn og adresse
 Nombre y dirección del cliente
 Asiakkaan nimi & osoite
 Ονομα και διεύθυνση αγοραστή
 Nome e indirizzo del cliente
 Kundens navn og adresse
 Nome e morada do comprador
 Kundens namn & adress
 Naam & adres van de klant
 Nafn og heimilisfang kaupanda
 L-iseem u l-indirizz tax-xerrej
 Name & address of customer

See back cover for table of contents.

This warranty will be honored only in the U S A

KENWOOD LIMITED WARRANTY FOR CAR STEREO COMPONENTS

HOW LONG IS THE WARRANTY

Kenwood U S A Corporation ("Kenwood") warrants this product for a period of one (1) year from the date of original purchase

WHAT IS COVERED AND WHAT IS NOT COVERED

Except as specified below, this warranty covers all defects in material and workmanship in Kenwood car stereo components. The following are not covered by the warranty:

- 1 Any product which is not distributed in the U S A by Kenwood or which is not purchased in the U S A from an authorized Kenwood car stereo dealer or an automobile dealer unless the product is purchased through the U S A Military Exchange Service
- 2 Any product on which the serial number has been defaced, modified or removed
- 3 Damage deterioration or malfunction resulting from:
 - a Any shipment of the product (claims must be presented to the carrier)
 - b Installation or removal of the product
 - c Accident, acts of nature, misuse, abuse, neglect, unauthorized product modification or failure to follow instructions supplied with the product
 - d Repair or attempted repair by anyone not authorized by Kenwood
 - e Any other cause which does not relate to a product defect

WHO IS PROTECTED

This warranty is enforceable only by the original purchaser

WHAT WE WILL PAY FOR

We will pay for all labor and material expenses for covered items. Payment of shipping charges is discussed in the next section of this warranty

HOW TO OBTAIN WARRANTY SERVICE

If your KENWOOD product ever needs service:

- 1 Take or ship it to any KENWOOD Authorized Service Center in the U S A along with a complete description of the problem (if you are uncertain as to whether a Service Center is authorized, please call **1-800-KENWOOD** for the nearest Service Center **1-800-536-9663**)
- 2 Although you must pay any shipping charges if it is necessary to ship the product for warranty service, we will pay the return shipping charges if the repairs are covered by the warranty within the United States
- 3 Whenever your units are taken or sent for warranty service, you must include a copy of the original dated sales receipt as proof of warranty coverage

LIMITATION OF IMPLIED WARRANTIES

ALL IMPLIED WARRANTIES, INCLUDING WARRANTIES OF MERCHANTABILITY AND FITNESS FOR A PARTICULAR PURPOSE, ARE LIMITED IN DURATION TO THE LENGTH OF THIS WARRANTY

EXCLUSION OF DAMAGES

KENWOOD'S LIABILITY FOR ANY DEFECTIVE PRODUCT IS LIMITED TO THE REPAIR OR REPLACEMENT OF THE PRODUCT AT OUR OPTION. KENWOOD SHALL NOT BE LIABLE FOR:

- 1 INSTALLATION OR REMOVAL CHARGES, DAMAGE TO OTHER PROPERTY CAUSED BY ANY DEFECTS IN KENWOOD CAR STEREO COMPONENTS, DAMAGES BASED UPON INCONVENIENCE, LOSS OF USE OF THE PRODUCT; OR
 - 2 ANY OTHER DAMAGES, WHETHER INCIDENTAL, CONSEQUENTIAL OR OTHERWISE
- SOME STATES DO NOT ALLOW LIMITATIONS ON HOW LONG AN IMPLIED WARRANTY LASTS AND/OR DO NOT ALLOW THE EXCLUSION OR LIMITATION OF INCIDENTAL OR CONSEQUENTIAL DAMAGES, SO THE ABOVE LIMITATIONS AND EXCLUSIONS MAY NOT APPLY TO YOU

This warranty gives you specific legal rights, and you may also have other rights which vary from state to state

If a problem develops during or after the Limited Warranty Period, or if you have any questions regarding the operation of the product, you should contact your KENWOOD Authorized Dealer or Authorized Service Center. If the problem or your question is not handled to your satisfaction, please contact our Customer Relations Department at the address listed below:

Name of set / Nom de l'appareil /
Modello dell'apparecchio / Modelo

K W

KDC-X617



019048 126740



S/NO. 10101964

Serial No. / No. de serie / No. di serie

User name / Nom de l'utilisateur /
Nome del proprietario / Usuario

User address / Adresse de l'utilisateur /
Indirizzo / Dirección

Phone / Phono / Telefono / Teléfono

Sales date / Date d'achat / Data d'acquisto /
Fecha de venta

Dealer stamp / Cachet du vendeur / Sello del vendedor

Signature of Dealer / Signature du vendeur /
Firma del vendedor

This equipment pass is an important document. Please
fill it out completely and keep it in a safe place.

Cette carte est un document important. La remplir com-
plètement et la garder dans un endroit sûr.

Esta tarjeta es importante. Rellénela por favor y guárdela
para futura referencia.

B46-0606-04

Attention:

This card is necessary to buy the panel again because of theft or damage.

Attention:

Cette carte est nécessaire pour se procurer un nouveau panneau dans le cas de perte ou d'endommagement de celui que vous possédez.

Attentie:

Deze kaart is nodig als u een nieuw paneel with aanschaffen in geval van diefstal of beschadiging.

Attenzione:

Questa scheda è necessaria per acquistare un nuovo pannello frontale dopo un furto o danni.

Atención:

Esta tarjeta es necesaria para comprar el panel en el caso de que le haya sido robado o se haya estropeado.

KENWOOD

Car Audio Passport

KENWOOD CORPORATION

Please send other correspondence to:

Kenwood USA Customer Service

P.O. Box 22745

Long Beach, CA 90801-5745



NO POSTAGE
NECESSARY
IF MAILED
IN THE
UNITED STATES

87S01-01

BUSINESS REPLY MAIL

FIRST-CLASS MAIL PERMIT NO. 8439 LONG BEACH, CA

POSTAGE TO BE PAID BY ADDRESSEE

KENWOOD

PO BOX 173272

DENVER CO 80217-9165



The Kenwood SmartCard • Want to extend your warranty?*
Register your product on the web or by mail

**Free CD
sampler**

or

**A chance
to win
\$50,000**

Loaded with great new music
and mailed to you free when
you register on the web at
www.kenwoodusa.com
(U.S. residents only.)

You're entered to win when you
mail in this registration card

KENWOOD
eXcelon

CAR AUDIO

*A free 2 year warranty (1 year standard plus 1 year extra) for Kenwood eXcelon Products.
A free 3 year warranty (1 year standard plus 2 years extra) for Kenwood eXcelon Amplifiers.

1 Mr 2 Mrs 3 Ms 4 Miss
First Name Initial Last Name

Street

Apt. No.

City

State

ZIP Code

E-mail Address:

2 Model number:

13 Marital status: 1 Married 2 Single

3 Serial number:

14 **Not including yourself, what is the GENDER and AGE (in years) of children and other adults living in your household?**1 No one else in household 2 Child under 1 year

4 Date of purchase: / /

Male Female Age Male Female Age

1 2 yrs 1 2 yrs

5 Name of store where purchased:

1 2 yrs 1 2 yrs

6 Do you own Kenwood home audio products?

1 Yes 2 No

15 Which group describes your annual family income?

- | | |
|---|---|
| 01 <input type="checkbox"/> Under \$15,000 | 08 <input type="checkbox"/> \$75,000-\$99,999 |
| 02 <input type="checkbox"/> \$15,000-\$19,999 | 09 <input type="checkbox"/> \$100,000-\$124,999 |
| 03 <input type="checkbox"/> \$20,000-\$29,999 | 10 <input type="checkbox"/> \$125,000-\$149,999 |
| 04 <input type="checkbox"/> \$30,000-\$39,999 | 11 <input type="checkbox"/> \$150,000-\$174,999 |
| 05 <input type="checkbox"/> \$40,000-\$49,999 | 12 <input type="checkbox"/> \$175,000-\$199,999 |
| 06 <input type="checkbox"/> \$50,000-\$59,999 | 13 <input type="checkbox"/> \$200,000-\$249,999 |
| 07 <input type="checkbox"/> \$60,000-\$74,999 | 14 <input type="checkbox"/> \$250,000 & over |

7 What factors most influenced this purchase?

(check all that apply)

- | | |
|--|--|
| 01 <input type="checkbox"/> Brand Name | 06 <input type="checkbox"/> Features/Technology |
| 02 <input type="checkbox"/> Store Display | 07 <input type="checkbox"/> Previous Experience with Kenwood |
| 03 <input type="checkbox"/> Salesperson's Recommendation | 08 <input type="checkbox"/> Warranty |
| 04 <input type="checkbox"/> Friend's Recommendation | 09 <input type="checkbox"/> Availability |
| 05 <input type="checkbox"/> Price | 10 <input type="checkbox"/> Upgradability |
| | 11 <input type="checkbox"/> Web Site |
| | 12 <input type="checkbox"/> Other _____ |

16 For your primary residence, do you:

1 Own? 2 Rent?

17 To help us understand our customers' lifestyles, please indicate the interests and activities in which you or your spouse enjoy participating on a regular basis

- | | |
|--|--|
| 1 <input type="checkbox"/> Crafts | 6 <input type="checkbox"/> Hunting/Shooting |
| 2 <input type="checkbox"/> Listen to Records/Tapes/CDs | 7 <input type="checkbox"/> Stock/Bond Investments |
| 3 <input type="checkbox"/> Avid Book Reading | 8 <input type="checkbox"/> Entering Sweepstakes |
| 4 <input type="checkbox"/> Bible/Devotional Reading | 9 <input type="checkbox"/> Wildlife/Environmental Issues |
| 5 <input type="checkbox"/> Foreign Travel | 10 <input type="checkbox"/> Casino Gambling |

8 What features most influenced this purchase?

(check all that apply)

- | | |
|---|---|
| 1 <input type="checkbox"/> Sound Quality | 4 <input type="checkbox"/> Ease of Installation |
| 2 <input type="checkbox"/> Cosmetic Design | 5 <input type="checkbox"/> Size |
| 3 <input type="checkbox"/> Technical Specifications | 6 <input type="checkbox"/> Ease of Operation |
| | 7 <input type="checkbox"/> Other _____ |

9 What other brands did you consider?

- | | |
|-------------------------------------|---|
| 01 <input type="checkbox"/> None | 07 <input type="checkbox"/> MTX |
| 02 <input type="checkbox"/> Alpine | 08 <input type="checkbox"/> Panasonic |
| 03 <input type="checkbox"/> Aiwa | 09 <input type="checkbox"/> Pioneer |
| 04 <input type="checkbox"/> Clarion | 10 <input type="checkbox"/> Rockford |
| 05 <input type="checkbox"/> Eclipse | 11 <input type="checkbox"/> Sony |
| 06 <input type="checkbox"/> JVC | 12 <input type="checkbox"/> Other _____ |

10 Please tell us the manufacturer, model, and year of the vehicle into which this product will be installed:

1) Mfrct:

Model:

Year:

11 Do you plan to/did you install this product yourself?

1 Yes 2 No

12 Your date of birth: / /

Thanks for taking the time to fill out this questionnaire. Your answers will be used for market research studies and reports. They will also allow you to receive important mailings and special offers from a number of fine companies whose products and services relate directly to the specific interests, hobbies and other information indicated above. Through this selective program, you will be able to obtain more information about activities in which you are involved and less about those in which you are not. Please check here if for some reason, you would prefer not to participate in this opportunity

Please check here if you do not want to receive mailings and offers using your E-mail address

Copyright © 2000 All Rights Reserved Please seal with tape Do not staple

OFFICIAL RULES: NO PURCHASE NECESSARY TO WIN. Sweepstakes is sponsored by a number of different companies, will be offered in a number of different presentations, and will award the following prizes: one 1st Prize of \$50,000, one 2nd Prize of \$25,000, and five 3rd Prizes of \$5,000. Sweepstakes begins May 20, 1999, and ends December 31, 2001. Enter by completing this product registration or a 3" x 5" card with your name, address, city, state, ZIP Code, and the words "\$100,000 Give Away III" and mail to P.O. Box 173272 Dept. 87S Denver CO 80217 9165. Entries must be received no later than December 31, 2001, and are limited to one per household. Mechanically reproduced entries not acceptable. Not responsible for late, lost or illegible entries. A random drawing held in January 2002, will select the winners from all entries collectively received by the sponsoring companies. Odds of winning depend on the number of eligible entries received from all sponsors' presentations. Open to U.S. residents at least 18 years old, except employees and their families of the sweepstakes judge, all of the sponsoring companies, and their respective subsidiaries. Each winner must submit a signed and notarized affidavit of eligibility within a specified time after being notified of their prospective winner status, and if a satisfactory affidavit is not received within the stated time, a new winner will be selected by submitting an entry, winner agrees to the use of their name, address, and photograph for advertising/publicity purposes without compensation. All entries become the property of the sweepstakes judge. No transfer or substitution of prizes is allowed. Winner is solely responsible for all taxes. All federal, state and local laws apply. Offer void in Florida and where prohibited by law. For notice of sweepstakes winners, send a self-addressed stamped envelope to: "\$100,000 Give Away III" P.O. Box 173133 Denver CO 80217 3133