

KENWOOD

CD-RECEIVER

KDC-MP5043U

KDC-MP543U

KDC-MP443U

INSTRUCTION MANUAL

Kenwood Corporation



Contents

Before use	3	Appendix	14
Basic Operation	4	Accessories/ Installation Procedure	17
General functions		Connecting Wires to Terminals	18
Tuner functions		Installation/Removing the Unit	19
Disc & Audio file play functions		Troubleshooting Guide	20
Menu System	6	Specifications	22
Clock/ Display Settings	7		
Manual Clock Adjustment			
Text Display Selection			
Auxiliary Input Display Setting			
Music disc/Audio file Operation	8		
Music Search			
Music Search for iPod			
All Random			
iPod Control by Hand Mode			
Direct Music Search			
Direct Disc Search			
Basic Operation of Disc Changer (Optional)			
Tuner Operation	10		
Frequency Step Setting			
Other Functions	10		
Activating Security Code			
Deactivating Security Code			
Demonstration mode setting			
Audio Adjustments	12		
Audio Control			
Audio Setup			
Speaker Setting			
Basic Operations of remote control	13		

iPod is a trademark of Apple Inc., registered in the U.S. and other countries.
“Made for iPod” means that an electronic accessory has been designed to connect specifically to iPod and has been certified by the developer to meet Apple performance standards.
Apple is not responsible for the operation of this device or its compliance with safety and regulatory standards.

Before use

▲WARNING

To prevent injury or fire, take the following precautions:

- To prevent a short circuit, never put or leave any metallic objects (such as coins or metal tools) inside the unit.

Before using this unit for the first time

This unit is initially set on the Demonstration mode. When using this unit for the first time, cancel the <Demonstration mode setting> (page 11).

How to reset your unit

- If this unit or the connected unit (disc auto changer, etc.) fails to operate properly, press the Reset button. The unit returns to factory settings when the Reset button is pressed.

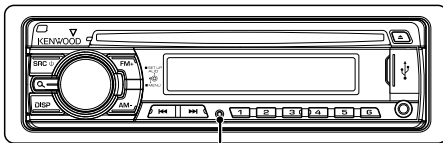

Reset button

Cleaning the Unit

If the faceplate of this unit is stained, wipe it with a dry soft cloth such as a silicon cloth. If the faceplate is stained badly, wipe the stain off with a cloth moistened with neutral cleaner, then wipe it again with a clean soft dry cloth.



- Applying spray cleaner directly to the unit may affect its mechanical parts. Wiping the faceplate with a hard cloth or using a volatile liquid such as thinner or alcohol may scratch the surface or erase characters.

Cleaning the Faceplate Terminals

If the terminals on the unit or faceplate get dirty, wipe them with a clean soft dry cloth.

Lens Fogging

When you turn on the car heater in cold weather, dew or condensation may form on the lens in the CD player of the unit. Called lens fogging, this condensation on the lens may not allow CDs to play. In such a situation, remove the disc and wait for the condensation to evaporate. If the unit still does not operate normally after a while, consult your Kenwood dealer.

- If you experience problems during installation, consult your Kenwood dealer.
- When you purchase optional accessories, check with your Kenwood dealer to make sure that they work with your model and in your area.
- The characters which can be displayed by this unit are A-Z 0-9 @ " ' ` % & * + - = , . / \ < > [] () ; : ^ - { } | ~ .
- The illustrations of the display and the panel appearing in this manual are examples used to explain more clearly how the controls are used. Therefore, what appears on the display in the illustrations may differ from what appears on the display on the actual equipment, and some of the illustrations on the display may be inapplicable.

Handling CDs

- Do not touch the recording surface of the CD.
- Do not stick tape etc. on the CD, or use a CD with tape stuck on it.
- Do not use disc type accessories.
- Clean from the center of the disc and move outward.
- When removing CDs from this unit, pull them out horizontally.
- If the CD center hole or outside rim has burrs, use the CD only after removing the burrs with a ballpoint pen etc.

CDs that cannot be used

- CDs that are not round cannot be used.

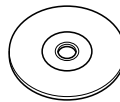

- CDs with coloring on the recording surface or CDs that are dirty cannot be used.

- This unit can only play the CDs with Compact Disc Recordable or Compact Disc ReWritable.

This unit may not correctly play discs which do not have the mark.

- You cannot play a CD-R or CD-RW that has not been finalized. (For the finalization process refer to your CD-R/CD-RW writing software, and your CD-R/CD-RW recorder instruction manual.)

Basic Operation

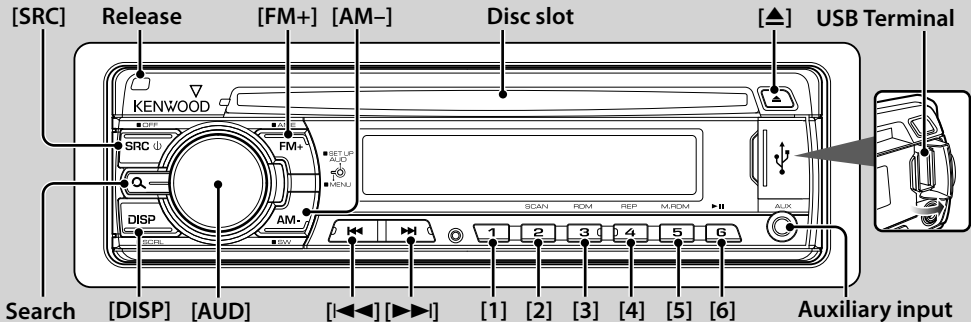

General functions

Power/Source Select button: [SRC]

Turns on the power.

When the power is on, the source switches between Tuner ("TUNER"), USB or iPod*1 ("USB" or "iPod"), CD ("CD"), Auxiliary input ("AUX"), and Standby ("STANDBY") each time this button is pressed. Press at least 1 second to turn off the power.



- When an optional accessory is connected, the source name for each device appears.
- When connection of the iPod is recognized, the source display changes from "USB" to "iPod".

*1 Function of KDC-MP5043U/ MP543U.

Volume control: [AUD] knob

Turn the knob to adjust the volume.

Subwoofer output: [AM-]

Switches between ON ("SW ON") and OFF ("SW OFF") each time this button is pressed for at least 2 seconds.



- You can do this function when "SWPRE" in <Menu System> (page 6) is set to "SW".

Auxiliary input

Connect a portable audio device with mini-plug cable (3.5 Ø).



- Use the mini-plug cable which is stereo type and does not have any resistance.
- The auxiliary input requires the setting made in "AUX" of <Menu system> (page 6).

Faceplate release: Release

Releases the faceplate lock so that it can be removed. Refer to the following diagram when reattaching the faceplate.

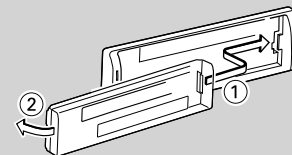

- The faceplate is a precision piece of equipment and can be damaged by shocks or jolts.
- Keep the faceplate in its faceplate case while detached.
- Do not place the faceplate (and the faceplate case) in areas exposed to direct sunlight, excessive heat or humidity. Also avoid places with too much dust or the possibility of water splashing.
- To prevent deterioration, do not touch the terminals of the unit or faceplate with your fingers.

Switching display: [DISP]

Changing the information displayed. Refer to page 7 for the details of the display setting.

Text/Title scroll: [DISP]

Scrolls the CD and audio file text display when pressed for at least 1 second.

Muting volume upon reception of phone call

When there is a call, "CALL" is displayed and the audio system is paused.

When the call ends, "CALL" disappears and the audio system comes back on.

The audio system comes back on when [SRC] is pressed during a call.



- To use the TEL Mute feature, you need to hook up the MUTE

wire to your telephone using a commercial telephone accessory. Refer to <Connecting Wires to Terminals> (page 18).

Tuner functions

FM band: [FM+]

Switches between FM1, FM2, and FM3 each time the [FM+] button is pressed.

AM band: [AM-]

Switches to AM.

Tuning: [◀◀]/ [▶▶]

Changes the frequency.



- Use the "AUTO1"/"AUTO2"/"MANUAL" in <Menu system> (page 6) to change the frequency switching.
- During reception of stereo stations the "ST" indicator is ON.

Preset memory: [1] - [6]

Memorizes the station selected when pressing for at least 2 seconds.

Auto memory entry: [FM+]

Memorizes 6 stations with good reception automatically when pressed for at least 2 seconds.

Preset tuning: [1] - [6]

Recalls the memorized station.

Disc & Audio file play functions

Disc play: Disc slot

Starts playing when a disc is inserted.

When a CD is inserted, the "IN" indicator is ON.



- 3 inch (8 cm) CD cannot be used. Attempt to insert using an adapter can cause malfunction.

Disc ejection: [▲]



- You can eject the disc for 10 minutes after switching off the engine.

USB device/iPod*1 play: USB Terminal

Connecting a USB device starts playback.



- For the playable audio file, media, and devices, refer to <About Audio file> (page 14).

*1 Function of KDC-MP5043U/ MP543U.

Pause and play: [6]

Switches between pause and play each time this button is pressed.

USB device removing: [▲]

Press this button for 2 seconds or longer to select the remove mode, and the remove the USB device. During the remove mode, "REMOVE" is displayed.

Music search: [◀◀]/ [▶▶]

Changes the music when this button is pressed.

Fast reverses or forwards the music while pressing. (No sound is output while playing audio file.)

Folder search: [FM+]/ [AM-]

Changes the folder containing the audio file.

Search mode: Search

After pressing this button, you can quickly search songs with the [AUD] knob. See <Music Search> (page 8) for details.

Track/ File/ Folder repeat play: [4]

Switches between Track Repeat ("TRAC REP") and OFF ("REP OFF") when pressed while playing a CD.

Switches between File Repeat ("FILE REP"), Folder Repeat ("FOLD REP"), and OFF ("REP OFF") when pressed while playing an audio file.



- The folder repeat operation cannot be performed while iPod is playing.

Scan play: [2]

Successively plays the intro of the music in the disc or folder.

When Scan Play is turned on, "TRAC SCN"/ "FILE SCN" is displayed.



- The Scan play operation cannot be performed while iPod is playing.

Random play: [3]

Randomly plays the music in the disc or folder.

When Random Play is turned on, "DISC RDM"/ "FOLD RDM" is displayed.

Menu System

Set up the following functions.

Item	Setting	Entry	Setting overview	Condition	Page
"CODE SET"/ "CODE CLR"		1 sec.	Sets/Resets security code.	SB	10, 11
"SKIP" ^{*1}	"0.5%"/"1%"/ "5%"/"10%"		Sets the ratio of skip performed with <Music Search>.	iPod	8
"DIM"	"OFF"/"ON"		Adjusts the brightness of the display according to the surrounding illumination.	—	
"ICON"	"OFF"/"ON1"/ "ON2"*		Sets the Graphics mode of the display.	SB	15
"SWPRE"	"R"/"SW"		Sets the preout output.	SB	15
"SPRM"	"OFF"/"ON"*		Turns ON/OFF the Supreme function.	AF	15
"AUTO1"/"AUTO2"/ "MANUAL"	"AUTO1"/"AUTO2"/ "MANUAL"		Selects the tuning mode of the radio.	Tuner	15
"CRSC"	"OFF"/"ON"*		Switches to Monaural to decrease noise when reception is poor.	FM	
"NAME SET"		1 sec.	Sets the display when switched to AUX source.	AUX	7
"SCL"	"AUTO"/"MANU"		Specifies whether the text is scrolled automatically.	—	
"AUX"	"OFF"/"ON1"/ "ON2"		Sets whether to display AUX during source selection.	SB	15
"CD READ"	"1"/"2"		Sets the CD read mode.	SB	15
"DEMO"	"OFF"/"ON"*	2 sec.	Specifies whether to enable demonstration.	—	11

*Factory setting

*1 Function of KDC-MP5043U/ MP543U

Displayed item is depending on currently selected source or mode. The mark in Condition column shows the condition to which the item is displayed.

SB : Can be set in other than standby state.

SB : Can be set in standby state.

AF : Can be set while Audio file source of CD/USB (excluding iPod).

iPod : Can be set only during playback of the iPod source. (USB source used when the iPod is connected)

Tuner : Can be set during Tuner source.

FM : Can be set during FM reception.

AUX : Can be set while accessing AUX source.

— : Can be set during all sources.



- Refer to the respective page for information on how to set the items with reference page number.
- Only the items available to the current source are displayed.
- Strong electrical fields (such as from power lines) may cause unstable sound quality when CRSC is turned ON. In such a situation, turn it OFF.

1 Enter menu mode

Press the Search button for at least 1 second.

"MENU" is displayed.

2 Select the menu item

Press the [FM+] or [AM-] button.

3 Set the menu item

Press the [◀◀] or [▶▶] button.

4 Exit menu mode

Press the Search button.

Clock/ Display Settings

Manual Clock Adjustment

1 Select the Clock display

Press the [DISP] button.

2 Enter Clock adjustment mode

Press the [DISP] button for at least 1 second.

The clock display blinks.

3 Adjusting Clock

Operation type	Operation
Adjust the hours	Press the [FM+] or [AM-] button.
Adjust the minutes	Press the [◀◀] or [▶▶] button.

4 Exit Clock adjustment mode

Press the [DISP] button.

Text Display Selection

Changes displayed information on each source following;

In Tuner source

Information	Display
Frequency	"FREQ"
Clock	"CLOCK"

In CD & External disc source

Information	Display
Disc title	"D-TITLE"
Track title	"T-TITLE"
Play time & Track number	"P-TIME"
Clock	"CLOCK"

In Audio file source

Information	Display
Music title & Artist name	"TITLE"
Album name & Artist name	"ALBUM"
Folder name	"FOLDER"
File name	"FILE"
Play time & Music number	"P-TIME"
Clock	"CLOCK"

In Standby/ Auxiliary input source

Information	Display
Source name	"SRC NAME"
Clock	"CLOCK"

Select the text

Press the [DISP] button.



- When you select the clock display, the display setting of each source will be changed to the clock display.
- If the selected display item does not have any information, alternative information is displayed.
- When selecting "Folder Name" while playing with iPod, names will be displayed depending on currently selected browsing items.
- If the iPod Control by Hand Mode is set to on while playing the iPod, "iPodMODE" is displayed.
- If all characters cannot be displayed while playing with iPod, the file number in the list is displayed.

Information	Display
Music title	"TITLE****"
Folder name	"FLD****"
File name	"FILE****"

Auxiliary Input Display Setting

Selecting the display when changing to Auxiliary input source.

1 Select Auxiliary input source

Press the [SRC] button.

Select the "AUX" display.

2 Enter Menu mode

Press the Search button for at least 1 second.

"MENU" is displayed.

3 Select Auxiliary input display setting mode

Press the [FM+] or [AM-] button.

Select the "NAME SET" display.

4 Enter Auxiliary input display setting mode

Press the [AUD] knob for at least 1 second.

The presently selected Auxiliary input display is displayed.

5 Select the Auxiliary input display

Press the [◀◀] or [▶▶] button.

"AUX" / "DVD" / "PORTABLE" / "GAME" / "VIDEO" / "TV"

6 Exit Auxiliary input display setting mode

Press the Search button.



- When operation stops for 10 seconds, the name at that time is registered, and the Auxiliary input display setting mode closes.
- The Auxiliary input display can be set only when the built-in auxiliary input or the auxiliary input of optional KCA-S220A is used. On the KCA-S220A, "AUX EXT" is displayed by default.

Music disc/Audio file Operation

Function of Audio file/ Internal CD source

Music Search

Selecting the music you want to listen to from the device or media being played now.

1 Enter Music Search mode

Press the Search button.

"SEARCH" is displayed.

Displays the current Audio file name.

2 Search for music

Audio file

Operation type	Operation
Movement between folders/files	Turn the [AUD] knob, or press the [FM+]/[AM-] button.
Selection of folder/file	Press the [AUD] knob or [▶▶] button.
Return to previous folder	Press the [◀◀] button.
Return to root folder	Press the [◀◀] button for at least 1 second.

 (ON) : Indicates that a folder exists above the currently selected folder.

 (OFF) : Indicates that no folder exists above the currently selected folder.

 (ON) : Indicates that a folder exists under the currently selected folder.

 (OFF) : Indicates that the currently displayed folder is not followed by a folder or file.

 (Blinking) : Indicates that your selection is a file.

Internal CD source

Operation type	Operation
Movement between track	Turn the [AUD] knob, or press the [FM+]/[AM-] button.
Selection of folder/file	Press the [AUD] knob.
Return to first track	Press the [◀◀] button for at least 1 second.

Cancelling the Music Search mode

Press the Search button.



- Music Search cannot be performed during Random play or scan play.

Function of KDC-MP5043U/ MP543U

Function of iPod

Music Search for iPod

Search for the song (in iPod) you want to play.

1 Enter Music Search mode

Press the Search button.

"SEARCH" is displayed.

8 | KDC-MP5043U/ KDC-MP543U/ KDC-MP443U

2 Search for music

Operation type	Operation
Movement between items	Turn the [AUD] knob.
Skip Search *1	Press the [◀◀] or [▶▶] button.
Selection of item	Press the [AUD] knob.
Return to previous item	Press the [FM+] button.
Return to Top menu	Press the [FM+] button for at least 1 second.
Search by initial	Press the Search button for at least 1 second.

The position of the currently displayed item is indicated by the icon bar in eight steps.

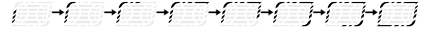

Cancelling the Music Search mode

Press the Search button.

Searching for Music by Initial

You can select an alphabetic character from the list in the browse item (artist, album, etc.) selected now.

1 Enter alphabetic search mode

Press the Search button for at least 1 second.

"A B C ..." is displayed.

- If you can not search for a song by an alphabetic character in the browse item selected now, the data on the screen does not change.

2 Select the initial to be searched for

Operation type	Operation
Move to the next character.	Turn the [AUD] knob, or press the [◀◀] / [▶▶] button.
Move to the next row.	Press the [FM+] or [AM-] button.
Cancelling the alphabet search mode	Press the Search button.

3 Determine the selected initial

Press the [AUD] knob.

Start search. When search is completed, the music search mode is selected again at the selected character position.



- *1 Skip Search: The number of songs to be skipped is determined by the ratio of the total number of songs in the list which is selected now. Set the ratio with "SKIP" in <Menu System> (page 6). Keep pressing this button for 3 seconds or longer skips songs at 10% irrespective of the setting.
- The time of search by alphabet may become long depending on the number of songs in iPod or the folder structure.
- When selecting an initial in the alphabet search mode, entering "*" searches symbols and entering "1" searches digits.
- If the first character string begins with an article "a", "an", or "the" in the alphabet search mode, it is searched for in defiance of the article.
- Characters that are included in a song name but cannot

be displayed are left blank. If no character included in a song name cannot be displayed, the browse item name and digits are displayed.

Items	Display	Items	Display
Playlists	"PLIST****"	Podcast	"PDCI****"
Artists	"ART****"	Genre	"GEN****"
Albums	"ALB****"	Composer	"COM****"
Music title or file name	"PRGM****"		

Function of KDC-MP5043U/ MP543U
Function of iPod

All Random

All songs in iPod are played at random.

Press the [3] button for at least 3 seconds.

Pressing the button toggles the setting between All random play on ("ALL RDM") and off ("RDM OFF").



- The time required to turn on the all random function may become longer depending on the number of songs in iPod or the folder structure.
- Turning on the all random function changes the iPod browse item to "songs". This browse item will not change even if the all random function is turned off.
- If the browse item is changed to search for music while the all random function is on, the all random function is turned off and the songs in the browse item are played at random.

Function of KDC-MP5043U/ MP543U
Function of iPod

iPod Control by Hand Mode

Allows you to operate iPod with the control on the iPod.

Press the [1] button.

Pressing the button toggles the setting between iPod control by hand mode on ("HANDS ON") and off ("MODE OFF").



- In the iPod Control by hand mode, iPod cannot be operated using this unit.
- This mode is not compatible with music information display. The display will show "iPodMODE".
- The following iPods cannot be controlled using this unit. iPod nano (1st generation), and iPod with video.
- iPod can be operated when it conforms to the iPod control function.

Function of remote control

Direct Music Search

Searchs the music by entering the track number.

1 Enter the music number

Press the number buttons on the remote control.

2 Search the music

Press the [◀◀] or [▶▶] button.

Canceling Direct Music Search

Press the [▶II] button.



- Direct Music Search cannot be performed during playing of iPod, Random play, or scan play.

Function of KDC-MP5043U/ MP543U
Function of disc changers with remote control

Direct Disc Search

Searchs the disc by entering the disc number.

1 Enter the disc number

Press the number buttons on the remote control.

2 Search the disc

Press the [FM+] or [AM-] button.

Canceling Direct Disc Search

Press the [▶II] button.



- Direct Disc Search cannot be performed during playing of Random play or scan play.
- Input "0" to select disc 10.

Function of KDC-MP5043U/ MP543U

Basic Operation of Disc Changer (Optional)

Selecting CD changer source

Press the [SRC] button.
 Select the "CD CH" display.

Music search

Press the [◀◀] or [▶▶] button.

Disc Search

Press the [FM+] or [AM-] button.

Playing the Current Song or Disc Repeatedly (Repeat play)

Press the [4] button.

Pressing the button repeatedly selects Track Repeat play on ("TRAC REP"), Disc Repeat play on ("DISC REP"), and Repeat play off ("REP OFF") sequentially.

Randomly plays the music in the disc changer (Magazine random play)

Press the [5] button.

Pressing the button toggles the setting between Magazine random play on ("MGZN RDM") and off ("RDM OFF").

Tuner Operation

Frequency Step Setting

Changing the tuning frequency step.
The original setting is FM band 50 kHz, and AM band 9 kHz.

1 Turn the power OFF

Press the [SRC] button for at least 1 second.

2 Switch the frequency step

While pressing the [1] and [5] buttons, press the [SRC] button.

Release your fingers from the button after the display appears.

The frequency step changes to FM band 200 kHz, and AM band 10 kHz.



- When the same operation is repeated, the frequency step returns to the original setting.
- When the frequency step is changed, the frequencies in the memory are deleted.

Other Functions

Activating Security Code

When Security Code is set, possibility of theft is reduced because input of Security Code is prompted to turn on the unit once it is turned off.



- You can set the Security Code with a 4 digit number of your choice.
- The Security Code cannot be displayed or referenced. Make a note of the Security Code and treasure it up.

1 Select Standby

Press the [SRC] button.

Select the "STANDBY" display.

2 Enter Menu mode

Press the Search button for at least 1 second.

"MENU" is displayed.

3 Select Security Code mode

Press the [FM+] or [AM-] button.

Select the "CODE SET" display.

4 Enter Security Code mode

Press the [AUD] knob for at least 1 second.

When "ENTER" is displayed, "CODE" is also displayed.

5 Enter Security Code

Operation type	Operation
Select the digits to enter	Press the [◀◀] or [▶▶] button.
Select the Security Code numbers	Press the [FM+] or [AM-] button.

6 Confirm the Security Code

Press the [AUD] knob for at least 3 seconds.

When "RE-ENTER" is displayed, "CODE" is also displayed.

7 Do the step 5 through 6 operation, and reenter the Security Code.

"APPROVED" is displayed.

The Security Code function activates.



- If you enter the wrong Code in steps 5 through 6, repeat from step 5.
- When the Security Code function is activated, "CODE SET" changes to "CODE CLR".
- To deactivate the Security Code function, see the next section <Deactivating Security Code>.

8 Exit Security Code mode

Press the Search button.

Entering Security Code

The Security Code is required to use the audio unit when the unit is first used after removed from the battery power source or the Reset button is pressed.

1 Turn the power ON.

2 Do the step 5 through 6 operation, and enter the Security Code.

"APPROVED" is displayed.

Now, you can use the unit.

Deactivating Security Code

To deactivate the Security Code function.

1 Select Standby

Press the [SRC] button.

Select the "STANDBY" display.

2 Enter Menu mode

Press the Search button for at least 1 second.

"MENU" is displayed.

3 Select Security Code mode

Press the [FM+] or [AM-] button.

Select the "CODE CLR" display.

4 Enter Security Code mode

Press the [AUD] knob for at least 1 second.

When "ENTER" is displayed, "CODE CLR" is also displayed.

5 Enter Security Code

Operation type	Operation
Select the digits to enter	Press the [◀◀] or [▶▶] button.
Select the Security Code numbers	Press the [FM+] or [AM-] button.

6 Press the [AUD] knob for at least 3 seconds.

"CLEAR" is displayed.

The Security Code function deactivates.

7 Exit Security Code mode

Press the Search button.



- If a wrong security code is entered, "ERROR" is displayed. Enter a correct security code.

Demonstration mode setting

Setting the demonstration mode as follows;

Display	Setting
"DEMO ON"	The Demonstration mode function is ON.
"DEMO OFF"	Exit Demonstration mode (Normal mode).

1 Enter Menu mode

Press the Search button for at least 1 second.

"MENU" is displayed.

2 Select Demonstration mode

Press the [FM+] or [AM-] button.

Select the "DEMO" display.

3 Set the Demonstration mode

Press the [AUD] knob for at least 2 seconds.

4 Exit Demonstration mode

Press the Search button.

Audio Adjustments

Audio Control

You can adjust following Audio Control items;

Adjustment Item	Display	Range
Subwoofer level	"SW L"	-15 — +15
Bass Boost	"B.BOOST"/"B.B"	"1"/"2"/"OFF" (The indicator turns on according to the setting.)
System Q	"NATURAL"/"ROCK"/"POPS"/"EASY"/"TOP40"/"JAZZ"/"GAME"/"USER"	Natural/Rock/Pops/Easy/Top 40/Jazz/Game/User setting
Bass level*	"BAS L"	-8 — +8
Middle level*	"MID L"	-8 — +8
Treble level*	"TRE L"	-8 — +8
Balance	"BAL"	Left 15 — Right 15
Fader	"FAD"	Rear 15 — Front 15

Exit Audio Control mode (Volume control mode)

* Source tone memory: Puts the set up value in the memory per source.



- "USER": This appears when Bass level, Middle level, and Treble level are adjusted. When "USER" is selected, these levels are recalled.

1 Select the source to adjust

Press the [SRC] button.

2 Enter Audio Control mode

Press the [AUD] knob.

3 Select the Audio item to adjust

Press the [AUD] knob.

4 Adjust the Audio item

Turn the [AUD] knob.

5 Exit Audio Control mode

Press any button.

Press a button other than the [AUD] knob.

Audio Setup

You can set Sound system, such as follows;

Adjustment Item	Display	Range
Low Pass Filter	"LPF"	80/120/160/Through(OFF) Hz
Volume offset	"V-OFF"	-8 — ±0 (AUX: -8 — +8)



- Volume offset: Sets each source's volume as a difference from the basic volume.

1 Select the source to adjust

Press the [SRC] button.

2 Enter Audio Setup mode

Press the [AUD] knob for at least 1 second.

3 Select the Audio Setup item to adjust

Press the [AUD] knob.

4 Adjust the Audio setup item

Turn the [AUD] knob.

5 Exit Audio Setup mode

Press the [AUD] knob for at least 1 second.

Speaker Setting

Fine-tuning so that the System Q value is optimal when setting the speaker type as follows;

Speaker type	Display
OFF	"SP OFF"
For 5 & 4 in. speaker	"SP 5/4"
For 6 & 6x9 in. speaker	"SP 6*9/6"
For the OEM speaker	"SP OEM"

1 Enter Standby

Press the [SRC] button.

Select the "STANDBY" display.

2 Enter Speaker Setting mode

Press the [AUD] knob.

3 Select the Speaker type

Turn the [AUD] knob.

4 Exit Speaker Setting mode

Press the [AUD] knob.

Basic Operations of remote control

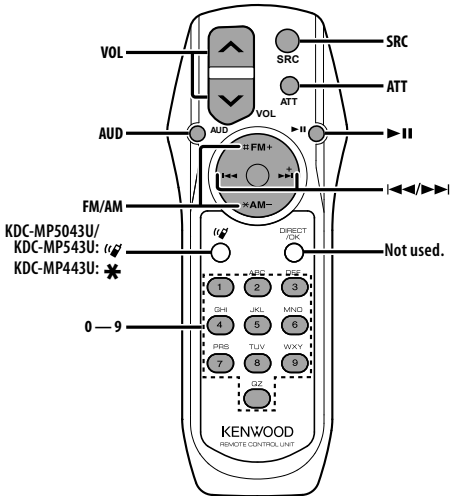

General control

Volume control: [VOL]

Source select: [SRC]

Volume reduce: [ATT]

When the button is pressed again, the volume returns to the previous level.

In Audio control

Audio item select: [AUD]

Adjust the Audio item: [VOL]



- Refer to <Audio Control> (page 12) for the operation method, such as the procedures for Audio control and others operations.

In Tuner source

Band select: [FM+]/[AM-]

Station select: [◀◀]/[▶▶]

Recall preset stations: [1] — [6]

In CD/USB source

Music select: [◀◀]/[▶▶]

Folder/Disc select: [FM+]/[AM-]

Pause/Play: [▶▶]



About [📶] (KDC-MP5043U/ MP543U)

This button is used when Bluetooth HANDS FREE BOX is connected. For more information, refer to the instruction manual of Bluetooth HANDS FREE BOX.

About [*] (KDC-MP443U)

Not used.



- Do not set the remote control in hot places such as on the dashboard.

Loading and Replacing battery

Use two "AA" / "R6"-size batteries.

Slide the cover while pressing downwards to remove it as illustrated.

Insert the batteries with the + and - poles aligned properly, following the illustration inside the case.

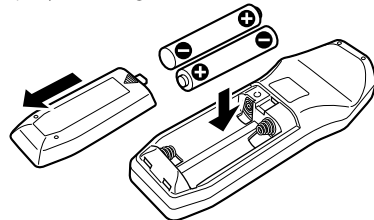

Appendix

About Audio file

- **Playable Audio file**
MP3 (.mp3), WMA (.wma)
- **Playable disc media**
CD-R/RW/ROM
- **Playable disc file format**
ISO 9660 Level 1/2, Joliet, Romeo, Long file name.
- **Playable USB device**
USB mass storage class
- **Playable USB device file system**
FAT16, FAT32
- **iPod Playable Model**
KDC-MP5043U/ MP543U

Although the audio files are complied with the standards listed above, the play maybe impossible depending on the types or conditions of media or device.

Playing order of the Audio file

In the example of folder/file tree shown below, the files are played in the order from ① to ⑩.

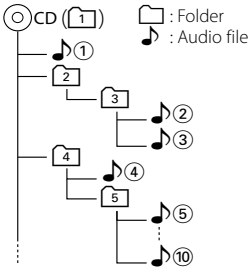

An online manual about audio files is put on the site, www.kenwood.com/audiofile/. On this online manual, detailed information and notes which are not written in this manual are provided. Make sure to read through the online manual as well.



- In this manual, the word "USB device" is used for flash memories and digital audio players which have USB terminals.
- The word "iPod" appearing in this manual indicates the iPod connected with the iPod connection cable* (optional accessory).

* Not supported model KCA-iP500.

Refer to the web site for connectable iPod and iPod connection cable.

www.kenwood.com/ipod/kca_ip/

About USB device

- If you start playback after connecting the iPod, the music that has been played by the iPod is played first.
In this case, "RESUMING" is displayed without displaying a folder name, etc. Changing the browse item will display a correct title, etc.
- You cannot operate iPod if "KENWOOD" or "✓" is displayed on iPod.
- When the USB device is connected to this unit, it can be charged up provided that this unit is powered.
- Install the USB device in the place where it will not prevent you from driving your vehicle properly.
- You cannot connect a USB device via a USB hub and Multi Card Reader.
- Take backups of the audio files used with this unit. The files can be erased depending on the operating conditions of the USB device.
We shall have no compensation for any damage arising out of erasure of the stored data.
- No USB device comes with this unit. You need to purchase a commercially available USB device.
- When connecting the USB device, usage of the CA-U1EX (option) is recommended.
Normal playback is not guaranteed when a cable other than the USB compatible cable is used.
Connecting a cable whose total length is longer than 5 m can result in abnormal playback.

For operating KCA-BT200 (Optional)

For operation refer to Model-A-1 in the Instruction Manual of KCA-BT200, and the table below. The [AUTO]/[TI] button should be replaced with [SRC] button for <Answering the Waiting Call after Terminating the Current Call>.

Notation used in the KCA-BT200 Instruction Manual	Operation
[▶] button	[AUD] knob
Control knob	[AUD] knob
[AUTO]/[TI] button	[DISP] button
Control knob towards up or down	[FM+] or [AM-] button
Control knob towards left or right	[◀◀] or [▶▶] button

For operating KCA-BT100 (Optional)

To control KCA-BT100, operate as follows;

To make setting for <Selecting the Dialing Mode>, select <Menu system> (page 6). Pressing the [AUD] knob for at least 1 second after selecting the "D.MODE" item allows you to enter the dialing method selection mode. To exit from dialing method selection mode, press Search button.

To make <Disconnecting a Call>, <Clearing the Disconnection Message>, and <Rejecting an Incoming call>, press [DISP] button for at least 1 second.

Moreover, some displays are different from the description of KCA-BT100 Instruction Manual.

Displays of KCA-BT100 Instruction Manual	Actual displays on this unit
"DISCONCT"	"HF D-CON"
"CONNECT"	"HF CON"
"PHN-DEL"	"DVC-DEL"
"P-STATUS"	"D-STATUS"
"BT-CON Y"	"HF-CON Y"
"BT-CON N"	"HF-CON N"

Menu Glossary

• ICON

Sets the Graphics mode of the display during normal playback condition.

ON1: Turns on.

ON2: Displays an animation.

OFF: Turns off.

• SWPRE (Switching Preout)

Switches the preout between rear output ("R") and subwoofer output ("SW").

• SPRM (Supreme)

Technology to extrapolate and supplement with proprietary algorithm, the high-frequency range that is cut off when encoding at low bit rate (less than 128Kbps, Sampling frequency is 44.1kHz). Supplementing is optimized by compression format (MP3 or WMA) and processed according to bit rate.

The effect is negligible with music that is encoded at high bit rate, variable bit rate or has minimal high frequency range.

• AUTO1, AUTO2, MANUAL (Tuning mode select)

Select a tuning mode of the radio.

Tuning mode	Display	Operation
Auto seek	"AUTO1"	Automatic search for a station.
Preset station seek	"AUTO2"	Search in order of the stations in the Preset memory.
Manual	"MANUAL"	Normal manual tuning control.

• AUX

When this is set to ON, AUX source can be selected. ON1: Outputs the sound of external unit connected to the AUX terminal when switched to AUX source.

ON2: Activates the attenuator function when switched to AUX source.

Turn off the attenuator function when listening to output from external unit. This prevents the noise when no external unit is connected to AUX terminal.

OFF: Disables the selection of AUX source.

Set to OFF when not using the AUX terminal.

• CD READ

Sets the method for reading CD.

When unable to play special format CD, set this function to "2" to force playing. Note that some music CD may be unplayable even when set to "2". In addition, audio files cannot be played when set to "2". Normally, keep this set to "1".

1 : Automatically distinguishes between audio file disc and music CD when playing disc.

2 : Forces playing as music CD.

Appendix

The marking of products using lasers (Except for some areas)



The label is attached to the chassis/case and says that the component uses laser beams that have been classified as Class 1. It means that the unit is utilizing laser beams that are of a weaker class. There is no danger of hazardous radiation outside the unit.

Accessories/ Installation Procedure

Accessories

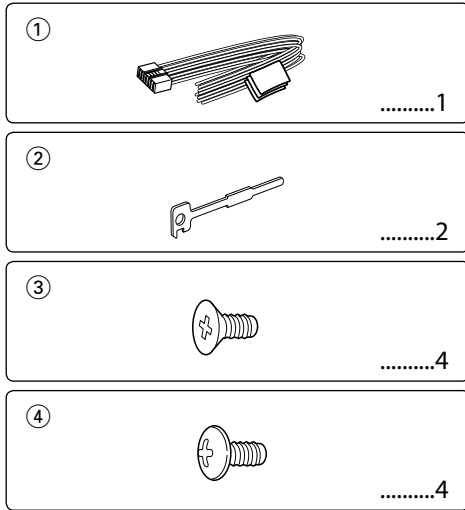

- Do not use your own screws. Use only the screws provided. If you use the wrong screws, you could damage the unit.
- If the power is not turned ON ("PROTECT" is displayed), the speaker wire may have a short-circuit or touched the chassis of the vehicle and the protection function may have been activated. Therefore, the speaker wire should be checked.
- If your car's ignition does not have an ACC position, connect the ignition wires to a power source that can be turned on and off with the ignition key. If you connect the ignition wire to a power source with a constant voltage supply, as with battery wires, the battery may die.
- If the console has a lid, make sure to install the unit so that the faceplate will not hit the lid when closing and opening.
- If the fuse blows, first make sure the wires aren't touching to cause a short circuit, then replace the old fuse with one with the same rating.
- Insulate unconnected wires with vinyl tape or other similar material. To prevent a short circuit, do not remove the caps on the ends of the unconnected wires or the terminals.
- Connect the speaker wires correctly to the terminals to which they correspond. The unit may be damaged or fail to work if you share the ⊖ wires or ground them to any metal part in the car.
- When only two speakers are being connected to the system, connect the connectors either to both the front output terminals or to both the rear output terminals (do not mix front and rear). For example, if you connect the ⊕ connector of the left speaker to a front output terminal, do not connect the ⊖ connector to a rear output terminal.
- After the unit is installed, check whether the brake lamps, blinkers, wipers, etc. on the car are working properly.
- Mount the unit so that the mounting angle is 30° or less.

Installation Procedure

1. To prevent a short circuit, remove the key from the ignition and disconnect the ⊖ battery.
2. Make the proper input and output wire connections for each unit.
3. Connect the speaker wires of the wiring harness.
4. Connect the wiring harness wires in the following order: ground, battery, ignition.
5. Connect the wiring harness connector to the unit.
6. Install the unit in your car.
7. Reconnect the ⊖ battery.
8. Press the reset button.

▲WARNING

If you connect the ignition wire (red) and the battery wire (yellow) to the car chassis (ground), you may cause a short circuit, that in turn may start a fire. Always connect those wires to the power source running through the fuse box.



- Mounting and wiring this product requires skills and experience. For safety's sake, leave the mounting and wiring work to professionals.
- Make sure to ground the unit to a negative 12V DC power supply.
- Do not install the unit in a spot exposed to direct sunlight or excessive heat or humidity. Also avoid places with too much dust or the possibility of water splashing.

About CD players/disc changers connected to this unit

If the CD player/ disc changer has the "O-N" switch, set it to the "N" position.

The functions you can use and the information that can be displayed may differ depending on the models being connected.

Connecting Wires to Terminals

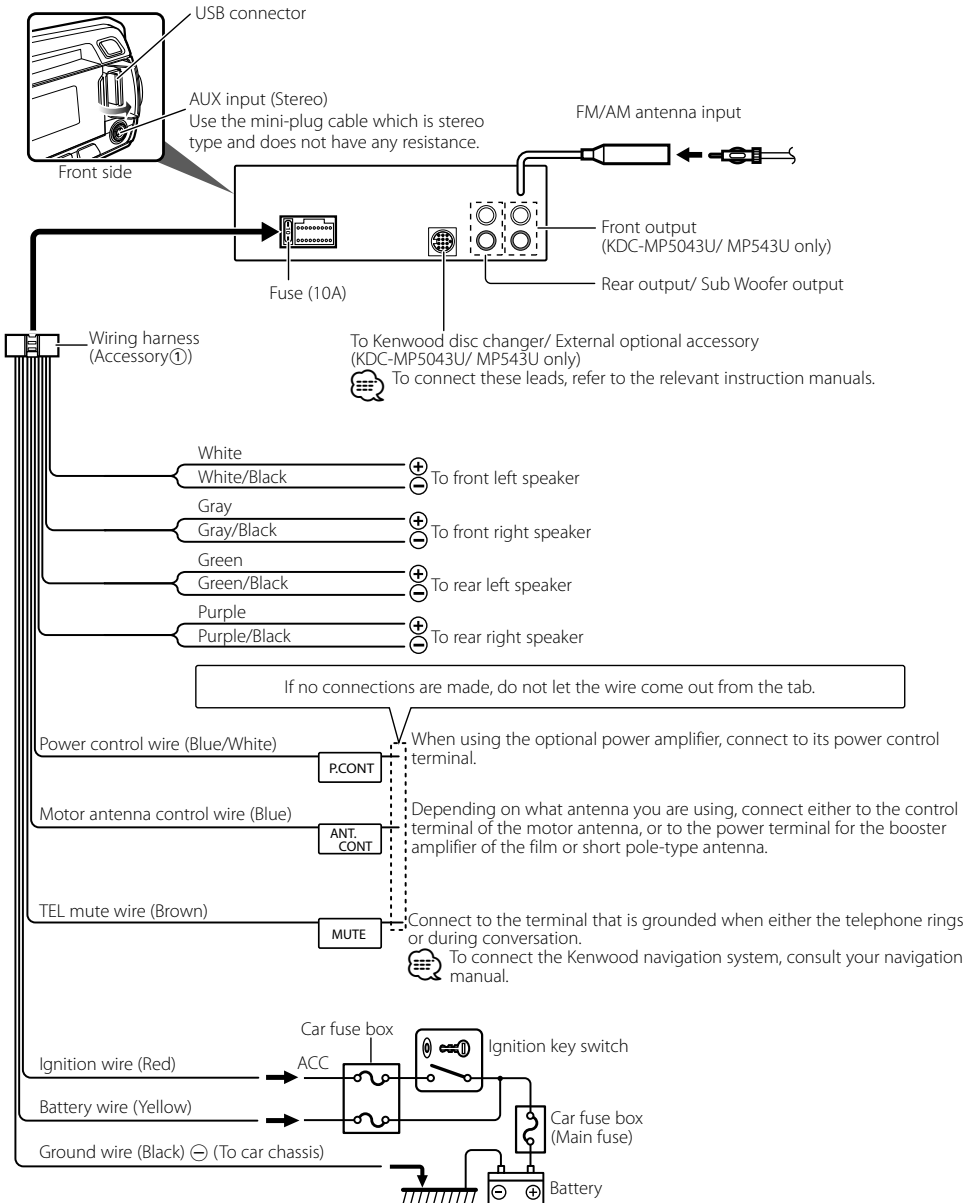

Installation/Removing the Unit

non-Japanese cars

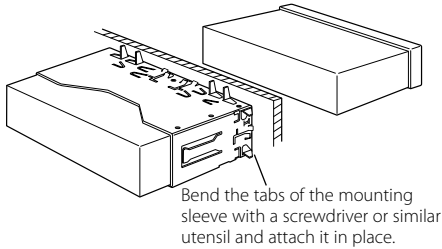

- Make sure that the unit is installed securely in place. If the unit is unstable, it may malfunction (for example, the sound may skip).

Japanese cars

- 1 Refer to the section <Removing the hard rubber frame> and then remove the hard rubber frame.
- 2 Align the holes in the unit (two locations on each side) with the vehicle mounting bracket and secure the unit with the accessory screws.

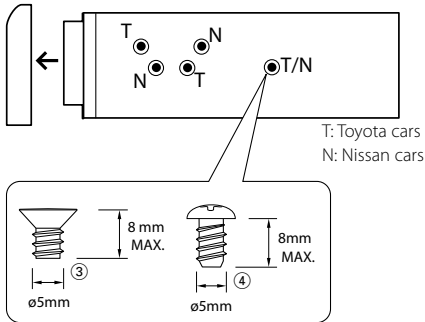

Removing the hard rubber frame

- 1 Engage the catch pins on the removal tool and remove the two locks on the upper level. Upper the frame and pull it forward as shown in the figure.

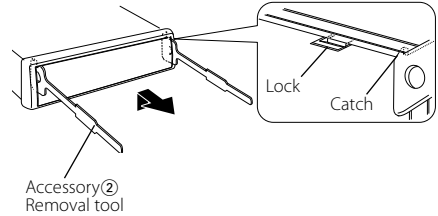

- 2 When the upper level is removed, remove the lower two locations.



- The frame can be removed from the bottom side in the same manner.

Removing the Unit

- 1 Refer to the section <Removing the hard rubber frame> and then remove the hard rubber frame.
- 2 Insert the two removal tools deeply into the slots on each side, as shown.
- 3 Lower the removal tool toward the bottom, and pull out the unit halfway while pressing towards the inside.

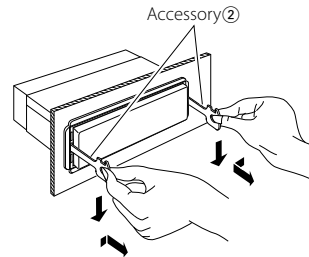

- Be careful to avoid injury from the catch pins on the removal tool.
- 4 Pull the unit all the way out with your hands, being careful not to drop it.

Troubleshooting Guide

Some functions of this unit may be disabled by some settings made on this unit.

- !** • **Cannot set up the subwoofer.**
 - **Cannot set up the low pass filter.**
 - **No output from the subwoofer.**
 - ▶ • <Subwoofer output> of <Basic Operation> (page 4) is not set to On.
 - Preout is not set to subwoofer.  "SWPRE" of <Menu system> (page 6)
-

- !** • **Cannot register a security code.**
 - **Cannot set up Display.**
 - ▶ • <Demonstration mode setting> (page 11) is not turned off.
-

What might seem to be a malfunction in your unit may just be the result of slight misoperation or miswiring. Before calling service, first check the following table for possible problems.

General

? The Touch Sensor Tone does not sound.

- ✓ The preout jack is being used.
 -  The Touch Sensor Tone cannot be output from the preout jack.
-



Tuner source

? Radio reception is poor.

- ✓ The car antenna is not extended.
 -  Pull the antenna out all the way.
-



Disc source

? The specified disc does not play, but another one plays instead.

- ✓ The specified CD is quite dirty.
 -  Clean the CD, referring to the CD cleaning of the section on <Handling CDs> (page 3).
 - ✓ The disc is loaded in a different slot from that specified.
 -  Eject the disc magazine and check the number for the specified disc.
 - ✓ The disc is severely scratched.
 -  Try another disc instead.
-

Audio file source

? The sound skips when an Audio file is being played.

- ✓ The media is scratched or dirty.
 -  Clean the media, referring to the CD cleaning of the section on <Handling CDs> (page 3).
 - ✓ The recording condition is bad.
 -  Record the media again or use another media.
-

Troubleshooting Guide

The messages shown below display your systems condition.

TOC ERR:	<ul style="list-style-type: none">• No disc has been loaded in the disc magazine.• The CD is quite dirty. The CD is upside-down. The CD is scratched a lot.	NA DVICE:	<ul style="list-style-type: none">• An unsupported USB device is connected.• Connection to the iPod has failed.⇨ Check that the connected iPod is an iPod that is supported. See <About Audio file> (page 14) for information on supported iPods.
E-05:	The disc is unreadable.	NO MUSIC/E-15:	<ul style="list-style-type: none">• The connected USB device contains no playable audio file.• Media was played that does not have data recorded that the unit can play.
E-77:	The unit is malfunctioning for some reason. ⇨ Press the reset button on the unit. If the "E-77" code does not disappear, consult your nearest service center.	USB ERR:	Some trouble may have occurred to the connected USB device. ⇨ Remove the USB device, then cycle the power switch to ON. If the same display is repeated, use another USB device.
E-99:	Something is wrong with the disc magazine. Or the unit is malfunctioning for some reason. ⇨ Check the disc magazine. And then press the reset button on the unit. If the "E-99" code does not disappear, consult your nearest service center.	iPod ERR:	Connection to the iPod has failed. ⇨ Remove the USB device and then reconnect it. ⇨ Confirm that the software for the iPod is the latest version.
IN (Blink):	The CD player section is not operating properly. ⇨ Reinsert the CD. If the CD cannot be ejected or the display continues to flash even when the CD has been properly reinserted, please switch off the power and consult your nearest service center.	REMOVE (Blink):	The Remove mode has been selected for the USB device/iPod. You can remove the USB device/iPod safely.
PROTECT (Blink):	The speaker wire has a short-circuit or touches the chassis of the vehicle, and then the protection function is activated. ⇨ Wire or insulate the speaker cable properly and press the reset button. If the "PROTECT" code does not disappear, consult your nearest service center.		
NA FILE:	An Audio file is played with a format that this unit can't support.		
COPY PRO:	A copy-protected file is played.		
READ ERR:	The file system of the connected USB device is broken. ⇨ Copy the files and folders for the USB device again. If the error message is still displayed, initialize the USB device or use other USB devices.		
NO DVICE:	The USB device is selected as a source although no USB device is connected. ⇨ Change the source to any source other than USB. Connect an USB device, and change the source to USB again.		

Specifications

FM tuner section

- Frequency range
 - 200 kHz space : 87.9 MHz – 107.9 MHz
 - 50 kHz space : 87.5 MHz – 108.0 MHz
- Usable sensitivity (S/N = 30dB)
 - : 9.3dBf (0.8 μ V/75 Ω)
- Quieting Sensitivity (S/N = 50dB)
 - : 15.2dBf (1.6 μ V/75 Ω)
- Frequency response (± 3 dB)
 - : 30 Hz – 15 kHz
- Signal to Noise ratio (MONO)
 - : 70 dB
- Selectivity (± 400 kHz)
 - : ≥ 80 dB
- Stereo separation (1 kHz)
 - : 40 dB

AM tuner section

- Frequency range
 - 10 kHz space : 530 kHz – 1700 kHz
 - 9 kHz space : 531 kHz – 1611 kHz
- Usable sensitivity (S/N = 20dB)
 - : 28 dB μ (25 μ V)

CD player section

- Laser diode
 - : GaAlAs
- Digital filter (D/A)
 - : 8 Times Over Sampling
- D/A Converter
 - : 24 Bit
- Spindle speed
 - : 500 – 200 rpm (CLV)
- Wow & Flutter
 - : Below Measurable Limit
- Frequency response (± 1 dB)
 - : 20 Hz – 20 kHz
- Total harmonic distortion (1 kHz)
 - : 0.01 %
- Signal to Noise ratio (1 kHz)
 - : 105 dB
- Dynamic range
 - : 93 dB
- MP3 decode
 - : Compliant with MPEG-1/2 Audio Layer-3
- WMA decode
 - : Compliant with Windows Media Audio

USB Interface

- USB Standard
 - : USB1.1/ 2.0 (Full speed)
- Maximum Supply current
 - : 500 mA
- File System
 - : FAT16/ 32
- MP3 decode
 - : Compliant with MPEG-1/2 Audio Layer-3
- WMA decode
 - : Compliant with Windows Media Audio

Audio section

- Maximum output power
 - : 50 W x 4
- Full Bandwidth Power (at less than 1% THD)
 - : 22 W x 4
- Speaker Impedance
 - : 4 – 8 Ω
- Tone action
 - Bass : 100 Hz ± 8 dB
 - Middle : 1 kHz ± 8 dB
 - Treble : 10 kHz ± 8 dB
- Preout level / Load (CD)
 - : 2000 mV/10 k Ω
- Preout impedance
 - : $\leq 600 \Omega$

Auxiliary input

- Frequency response (± 3 dB)
 - : 20 Hz – 20 kHz
- Input Maximum Voltage
 - : 1200 mV
- Input Impedance
 - : 10 k Ω

General

- Operating voltage (11 – 16V allowable)
 - : 14.4 V
- Maximum Current consumption
 - : 10 A
- Installation Size (W x H x D)
 - : 182 x 53 x 155 mm
- Weight
 - : 1.3 kg

Specifications subject to change without notice.