

# SANTO 72348 KA

## Electronic Refrigerator

### Operating Instructions

## Dear customer,

Before switching on your new refrigerator please read these operating instructions carefully. They contain important information for safe use, for installation and for care of the appliance.

Please keep these operating instructions for future reference. Pass them on to possible new owners of the appliance.



Notes which are important for your safety or for the proper functioning of the appliance are stressed with a warning triangle and/or with signal words (**Warning!**, **Caution!**, **Important!**). Please observe the following carefully.



1. This symbol and numbered instructions guide you step by step in the operation of the appliance.
2. ....



Supplementary information regarding operation and practical uses of the appliance appear after this symbol.



Tips and notes concerning economical and environmentally sound use of the appliance are marked with the cloverleaf.

Explanations of the technical terminology used in the operating instructions can be found at the end in the section "Technical Terminology".

The operating instructions contain instructions for the correction of possible malfunctions by the user in the section "What to do if ...". If these instructions should not be sufficient, please contact your local AEG Service Force Centre.

If you require assistance or advice on your appliance, please contact our Customer Care Department by letter or telephone:

Customer Care Department  
AEG Domestic Appliances  
55-77 High Street  
Slough  
Berkshire SL 1 1DZ

Tel: 08705 350350

Printed on paper manufactured with environmentally sound processes.  
he who thinks ecologically acts accordingly ...

---

# Contents

<b>Important Safety Instructions</b> .....	5
<b>Environmental Information</b> .....	7
Packaging .....	7
Old Appliances .....	7
<b>Appliance Transport</b> .....	7
<b>Before Use</b> .....	8
Packaging .....	8
<b>Fitting the Door Handles</b> .....	9
<b>Installation</b> .....	10
Installation Location .....	10
The Refrigerator needs Ventilation .....	11
Appliance Alignment .....	11
Electrical Connection .....	12
Installation of the carbon filter .....	13
<b>Reversing the Door</b> .....	13
<b>Description of the Appliance</b> .....	16
Control Panel .....	17
Buttons for Adjusting the Temperature .....	17
Temperature Display .....	18
ALARM OFF button .....	18
<b>Prior to Initial Start-Up</b> .....	18
<b>Initial Start-Up</b> .....	19
<b>Temperature Adjustment</b> .....	19
<b>COOLMATIC</b> .....	20
COOLMATIC button .....	20
Quick chill .....	20
<b>"Open Door" Warning</b> .....	21
<b>Temperature warning</b> .....	21
<b>Switching the Appliance off</b> .....	21
<b>Holiday Mode</b> .....	22

<b>Opening the Door</b>	22
<b>Interior Fittings</b>	23
Storage Shelves	23
Salad Bin	23
Bottle Rack	24
Quick Chill Shelf	24
Bottle and Can Holder	24
Dismantling of the Bottle and Can Holder	25
Variable Inner Door	25
Bottle Holder	25
<b>Proper Storage</b>	26
<b>Hints and Tips</b>	27
Normal Operating Sounds	27
Food Storage	27
Energy Saving Advice	27
<b>Defrosting</b>	28
<b>Maintenance and Cleaning</b>	28
Internal Cleaning	28
External Cleaning	28
Changing the carbon filter	29
Replacing the Light Bulb	30
<b>What to do if ...</b>	31
<b>Regulations, Standards, Guidelines</b>	32
<b>Technical Terminology</b>	33
<b>Guarantee Conditions</b>	34
<b>Service &amp; Spare Parts</b>	35



# Important Safety Instructions

These warnings are provided in the interests of your safety. Ensure that you understand them all before installing or using this appliance. Your safety is of paramount importance. If you are unsure about any of the meanings of these warnings contact the Customer Care Department.

## Prior to Installation

- Check the refrigerator for transport damage. Under no circumstances should a damaged appliance be installed! In the event of damage, please contact your retailer.

## Installation

- This appliance is heavy. Care should be taken when moving it.
- It is dangerous to alter the specifications or attempt to modify this product in any way.
- Ensure that the appliance does not stand on the electrical supply cable. If the supply cable is damaged, it must be replaced by a Service Force engineer.
- Make sure that the power plug is not squashed or damaged by the back of the appliance. A damaged power plug may overheat and cause a fire.
- If the power plug socket is loose, do not insert the power plug. There is a risk of electric shock or fire.
- Any electrical work required to install this appliance should be carried out by a qualified electrician or competent person.
- Parts which heat up should not be exposed. Whenever possible, the back of the appliance should be close to a wall, but leaving the required distance for ventilation, as stated in the installation instructions.
- The appliance should be left for 2 hours after installation before it is turned on, in order to allow the refrigerant to settle.

## Refrigerant

The refrigerant isobutane (R600a) is contained within the refrigerant circuit of the appliance, a natural gas with a high level of environmental compatibility, which is nevertheless flammable.

- During transportation and installation of the appliance, be certain that none of the components of the refrigerant circuit become damaged.

- If the refrigerant circuit should become damaged:
  - avoid open flames and sources of ignition;
  - thoroughly ventilate the room in which the appliance is situated.

### **Child Safety**

- Do not allow children to tamper with the controls or play with the product.
- Keep packaging material away from children! (There is a risk of suffocation!)

### **During Use**

- This appliance is designed for domestic use only, specifically for the storage of edible foodstuffs only. It is not intended for commercial or industrial use.
- Containers with flammable gases or liquids can leak at low temperatures. Do not store any containers with flammable materials such as, spray cans, fire extinguisher refill cartridges etc in the refrigerator.
- Manufacturers' recommended storage times should be adhered to. Refer to relevant instructions.

### **Maintenance and Cleaning**

- Before cleaning, always switch off the appliance and disconnect from the electrical supply.
- When unplugging always pull the plug from the mains socket, do not pull on the cable. Damage to the cable may cause a short circuit, fire and/or electric shock.

### **Servicing**

- This product should be serviced by our authorised engineer and only genuine spare parts should be used.
- Under no circumstances should you attempt to repair the appliance yourself. Repairs carried out by inexperienced persons may cause injury or serious malfunctioning. Contact your local AEG Service Force Centre.

# Environmental Information

## Packaging

All transit packaging materials are environmentally compatible and can be reused. Wood is un-treated. The plastics can be recycled and are identified as follows:

>PE< for polyethylene, e.g. the outer covering and the bags in the interior.

>PS< for polystyrene foam, e.g. the pads, which are pure hydrocarbon compounds and can be recycled.

The carton parts are made from recycled paper. Please dispose of the packaging with due care for the environment.

## Old Appliances

When disposing of your old appliance:

Make the appliance unusable by cutting off the cable and remove any door catches to ensure small children cannot be trapped inside.

Help to keep your country tidy - use an authorised disposal site.

## Appliance Transport

Two persons are required for transport of the appliance. There are two recessed handles at the front of the base and at the back of the appliance at the top for improved gripping.

1. Grip the appliance with the recessed handles positioned as in the drawing, and transport the appliance.

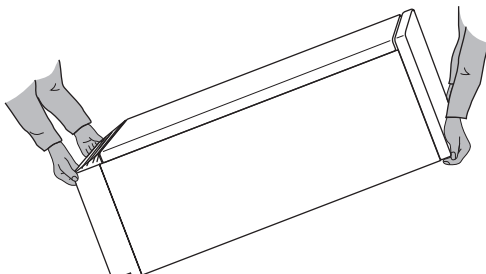

2. In order to push the appliance into its final position, press carefully at the top of the door and tip the appliance back slightly. The weight is then transferred to the back wheels and the appliance can be easily pushed.

# Before Use

## Packaging

 1. Remove all adhesive tape and packaging from the interior of the appliance.

 Any remnants of adhesive can be removed with white spirit.

2. Remove the transport protection pieces and pull off the adhesive tape.

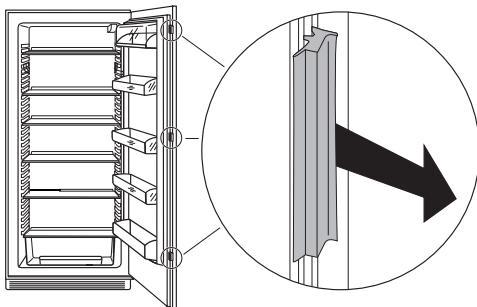

3. Wash the inside of the appliance with lukewarm water with a little bicarbonate of soda added (5 ml to 0.5 litre of water). Do not use soap or detergent as the smell may linger. Dry the appliance thoroughly.

Remove the transport fittings from the storage shelves:

4. Slide the fittings securing the shelf forward to the thicker section on the edge of the storage shelf.

5. Slide the storage shelf far enough forward so that it can be hinged downwards and the fittings can be removed from the guides.

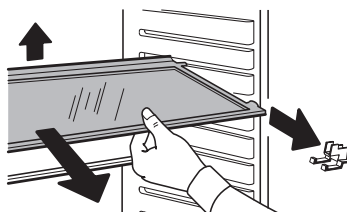
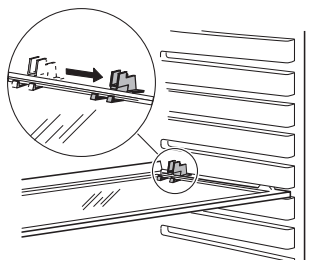



# Fitting the Door Handles



**Caution!** Do not use excessive force and overtighten the screws (max. 2 Nm) as you may damage the door handles.

-  1. Screw the top handle bracket to the handle rod (1). Fit the bottom handle bracket on the lower left-hand side of the door (2).

1

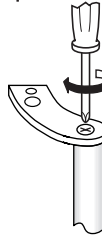

2



2. Fit the top handle bracket on the top left-hand side of the door (3) and screw the handle rod to the bottom handle bracket (4).

3

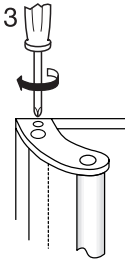

4

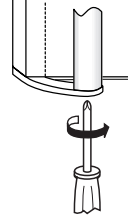

# Installation

## Installation Location

The appliance should be installed in a well ventilated, dry room.

Energy use is affected by the ambient temperature.

The appliance should therefore

- not be exposed to direct sunlight;
- not be installed next to radiators, cookers or other sources of heat;
- only be installed at a location whose ambient temperature corresponds to the climate classification, for which the appliance is designed.

The climate classification can be found on the rating plate, which is located at the left on the inside of the appliance.

The following table shows which ambient temperature is correct for each climate classification:

Climate classification	for an ambient temperature of
SN	+10 to +32 °C
N	+16 to +32 °C
ST	+18 to +38 °C
T	+18 to +43 °C

## The Refrigerator needs Ventilation

Air is fed under the door through the vent slots in the base and is exhausted upwards along the back wall. To ensure proper air circulation never cover or alter the vent openings.

**Important!** If the appliance is installed under a hanging cabinet, a clearance of at least 10 cm between the top of the appliance and the cabinet above it must be maintained.

Please check whether, after installing your appliance and especially after reversing the door, the door seal fits tightly. A badly fitting door seal may lead to heavy frosting and a higher power consumption (see also "Something not working").

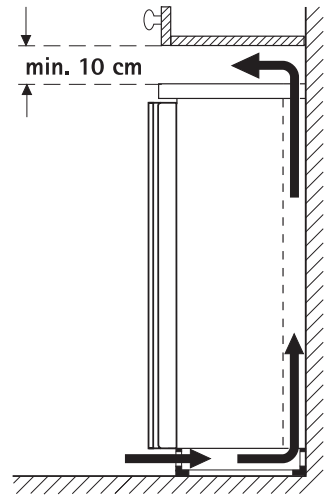

## Appliance Alignment

1. The appliance must be level, please compensate for unevenness in the floor by turning the two adjustable feet at the front.

## Electrical Connection

Any electrical work required to install this appliance should be carried out by a qualified electrician or competent person.



### WARNING – THIS APPLIANCE MUST BE EARTHED

The manufacturer declines any liability should these safety measures not be observed.

Before switching on, make sure the electricity supply voltage is the same as that indicated on the appliance rating plate. The rating plate is inside, on the left.

The appliance is supplied with a 13 amp plug fitted. In the event of having to change the fuse in the plug supplied, a 13 amp ASTA approved (BS 1362) fuse must be used.

### Important

The wires in the mains lead are coloured in accordance with the following code:

Green and Yellow	Earth
Blue	Neutral
Brown	Live

As the colours of the wires in the mains lead of this appliance may not correspond with the coloured markings identifying the terminals in your plug, proceed as follows:

1. The wire coloured green and yellow must be connected to the terminal marked with the letter "E" or by the earth symbol  $\oplus$  or coloured green and yellow.
2. The wire coloured blue must be connected to the terminal "N" or coloured black.
3. The wire coloured brown must be connected to the terminal marked "L" or coloured red.
4. Upon completion there must be no cut, or stray strands of wire present and the cord clamp must be secure over the outer sheath.

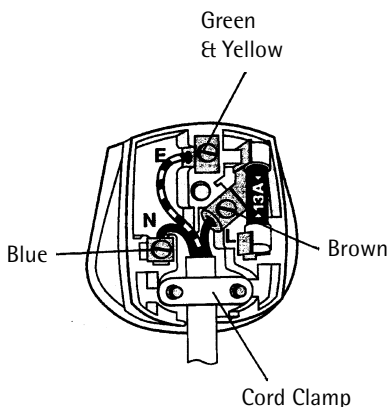

**Warning!** A cut-off plug inserted into a 13 amp socket is a serious safety (shock) hazard. Ensure that the cut-off plug is disposed of safely.

## Installation of the carbon filter

On delivery the carbon filter is placed in a plastic bag to ensure the length of life of the carbon filter. The filter should be placed behind the grill before the cabinet is turned on.

1. The cover can be opened by simultaneously pressing the lever on the right of grill (1) and pulling the cover outward (2).

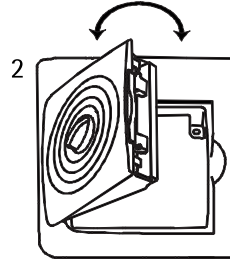
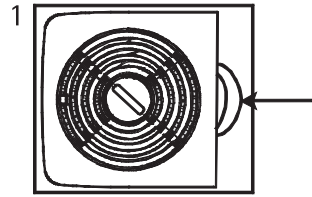

2. The carbon filter is then mounted in the slot found in the back of the cover (3).

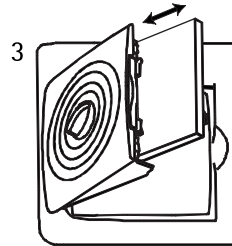

 The filter should be handled carefully so fragments don't loosen from the surface.

## Reversing the Door

The door hinges can be changed from right (as supplied) to left if required to suit the location where the appliance is installed.

 **Warning!** Unplug from the mains before reversing the door.

1. Open the door and remove the plinth cover to the front. Move the door hinge bracket cover on the plinth cover from the left to the right. Close the door.

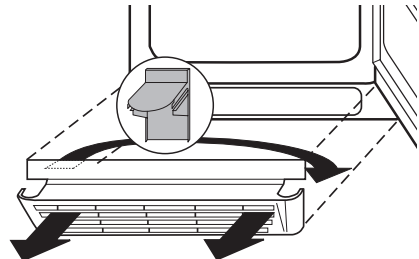

2. With the door closed, remove the cross-head screws from the lower door hinge bracket and remove the door hinge bracket downwards.

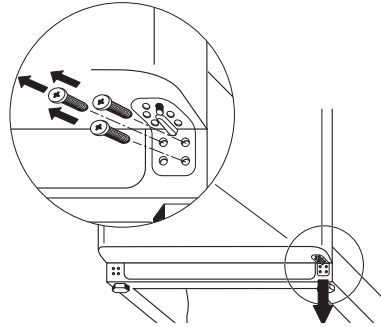

3. Remove the door fitting from the door hinge bracket (1, 2). Move the hinge bracket pivot from the right to the left hand hole (3). Place the door fitting supplied on the hinge bracket pivot (4, 5).

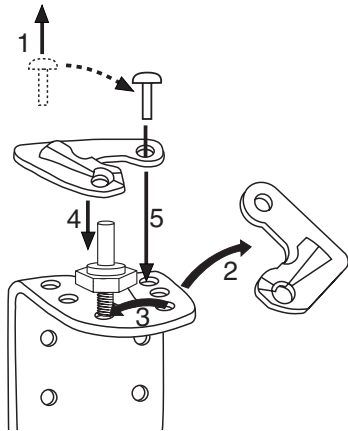

4. Remove the door fitting on the lower right (1) and reposition the door hinge bracket cover from the lower left to the right of the door (2), place the door fitting supplied in the lower left of the door (3). Carefully remove the door to the front and place on one side.

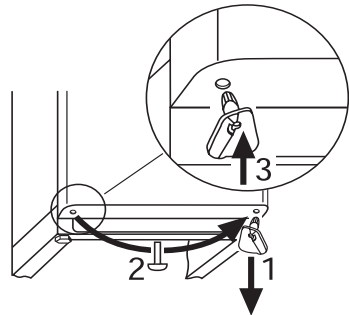

5. Move the upper hinge bracket pivot to the left.

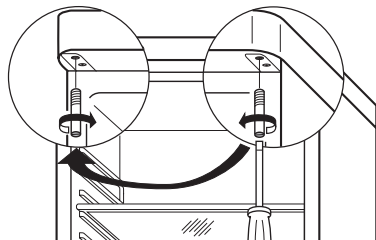

6. Carefully slide the door onto the top hinge bracket pivot and close.

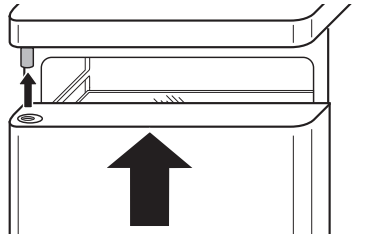

7. Place the lower door hinge bracket with the hinge bracket pivot in the lower left of the door and fasten.

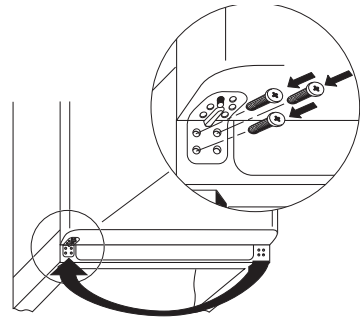

8. Open the door and fit the plinth.

9. Unscrew the top handle bracket from the handle rod (1). Unscrew the bottom handle bracket from the door (2).

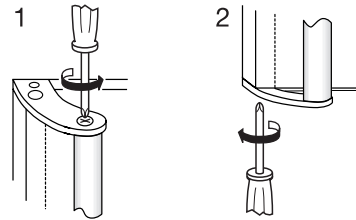

10. Unscrew the top handle bracket from the door (3) and screw onto the bottom right-hand side of the door (4).

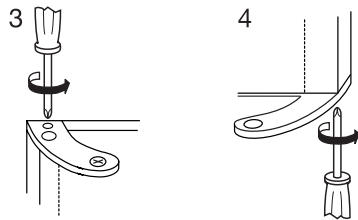

- Caution!** Do not use excessive force and overtighten the screws (max. 2 Nm) as you may damage the door handles.

11. Turn the handle bracket with the handle rod 180° and screw them to the door (5) and the fitted handle bracket (6).

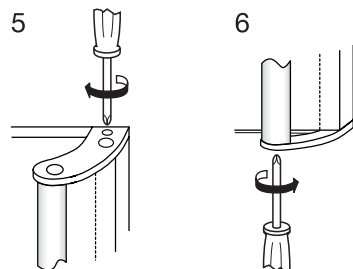

- Caution!** Do not use excessive force and overtighten the screws (max. 2 Nm) as you may damage the door handles.

# Description of the Appliance

## View of the appliance

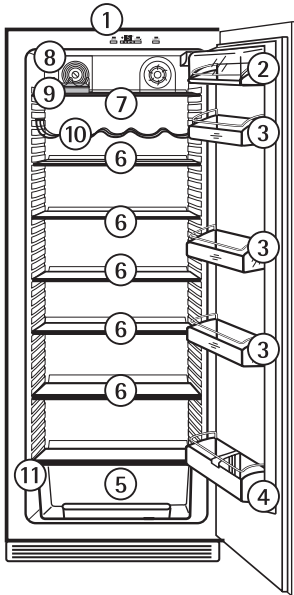

- ① Control panel
- ② Butter and cheese compartment with lid
- ③ Door storage compartments
- ④ Bottle compartment
- ⑤ Salad bin
- ⑥ Shelves
- ⑦ Quick chill shelf
- ⑧ Filter housing
- ⑨ Bottle and can holder
- ⑩ Bottle rack
- ⑪ Rating plate



## Control Panel

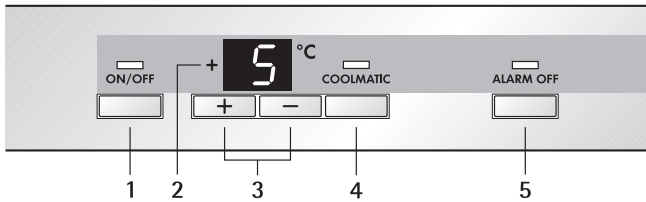

- 1 ON/OFF button
- 2 Temperature display
- 3 Buttons for adjusting the temperature
- 4 COOLMATIC button and COOLMATIC indicator light (yellow)
  - COOLMATIC for intensive cooling in the refrigerator
- 5 ALARM OFF button

## Buttons for Adjusting the Temperature



The temperature is adjusted using the „+“ (WARMER) and „-“ (COLDER) buttons.

These buttons are connected to the temperature display.

- The temperature display is switched over from the display of the ACTUAL temperature (Temperature display is illuminated) to the display of the DESIRED temperature (Temperature display flashes) by pressing one of the two buttons, „+“ (WARMER) or „-“ (COLDER).
- Each time one of the two buttons is pressed again the DESIRED temperature is adjusted by 1 °C.
- If neither button is pressed, the temperature display automatically switches back after a short period (approx. 5 sec.) to the display of the ACTUAL temperature.

DESIRED temperature means:

The temperature that is required in the fridge compartment, this can be adjusted to the temperatures shown in the display. The DESIRED temperature is indicated by flashing numbers.

ACTUAL temperature means:

The temperature display indicates the temperature that is currently present in the fridge compartment. The ACTUAL temperature is indicated with illuminated numbers.

## Temperature Display



The temperature display can indicate several pieces of information.

- During normal operation, the temperature currently present in the refrigerator (ACTUAL temperature) is displayed.
- When the temperature is being adjusted a flashing display indicates the fridge compartment temperature currently set (DESIRED temperature).
- If there is a fault in the appliance the temperature display shows a square or a letter in the temperature display.

## ALARM OFF button



With the ALARM OFF button, the acoustic warning signal can be switched off, e.g. the "Open Door" warning when sorting in or out, the food to be chilled.

## Prior to Initial Start-Up



Before connecting the appliance to the mains and starting it for the first time, leave the appliance to stand for 30 minutes if was transported upright. After transporting it on its side, the appliance must be left to stand for 2 hours before switching it on. This is necessary to allow the refrigerant to flow back into the compressor. Otherwise the compressor may be damaged.

1. Please clean the appliance interior and all accessories prior to initial start-up (see section: "Maintenance and Cleaning").
2. The appliance must be correctly installed in accordance with the chapter "Installation" before it is switched on for the first time. Care should be especially taken that the mains voltage and frequency available correspond with the appliance's rating plate.

# Initial Start-Up

1. Insert plug into mains socket.
2. Press ON/OFF button.  
A warning tone sounds and the red warning light flashes indicating that the required storage temperature has not yet been reached. The compressor starts and then runs automatically.
3. Press the ALARM OFF button to switch off the warning tone.
4. Set temperature to +5 °C or colder (see section: "Temperature Adjustment").

**i** Goods to be refrigerated can be loaded immediately after switching on, because the storage temperature in the refrigerator is quickly reached.

## Temperature Adjustment

With the buttons for temperature adjustment the desired temperatures in the refrigerator can be adjusted.

1. Press either the „+“ (WARMER) or „-“ (COLDER) button.  
The temperature display switches over and the DESIRED temperature currently set flashes on the temperature display.
2. To adjust to a warmer temperature, press the „+“ (WARMER) button. To adjust to a colder temperature, press the „-“ (COLDER) button. The changed setting is immediately displayed on the temperature display.

Each time the button is pressed the temperature is adjusted by 1 °C.  
Adjustable temperature range: +2 °C to +8 °C, +15 °C (Holiday mode)

**Note:** From a food safety point of view, +5 °C for the refrigerator compartment should be considered cold enough as a storage temperature.

**i** When the buttons are not pressed again after an adjustment has been made, after a short period (approx. 5 sec.) the temperature display switches over and again displays the ACTUAL temperature in the refrigerator. The display changes from flashing to static numbers.

The compressor will start and then run automatically.

**Information!** When the setting is changed, the compressor does not start immediately if automatic defrosting is currently taking place.

# COOLMATIC

## COOLMATIC button



The COOLMATIC function is suited for quick cooling of large quantities of goods in the refrigerator, e.g. drinks and salads for a party.

1. The COOLMATIC function is switched on by pressing the COOLMATIC button. The yellow light illuminates. The COOLMATIC function now provides for intensive cooling. A DESIRED temperature of +2 °C is automatically selected. The COOLMATIC function is ended automatically after a period of 6 hours. The originally selected DESIRED temperature is again valid. The temperature display shows the ACTUAL refrigerator temperature.
2. The COOLMATIC function can be ended manually at any time by pressing the COOLMATIC button again. The yellow light goes out.

**Important!** Once the COOLMATIC function has been switched on the DESIRED temperature that was set originally cannot be changed.

## Quick chill

The quick chill function can be used for the fast cooling of drinks in cans or bottles in the fast cool storage tray or of larger amounts of room-temperature food. The built-in charcoal filter reduces the development of any smell.

### Chilling of cans/bottles

Place cans or bottles in the holder on the quick chill shelf in front of the fan grill. Turn the fan regulator to maximum and press the COOLMATIC button. The yellow indicator light comes on.

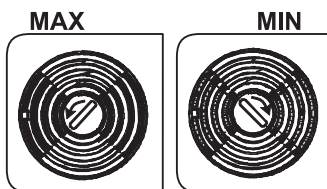

### Chilling of food

Place the food in the fridge. Open the fan regulator to maximum and press the COOLMATIC button. The yellow indicator light comes on.

When the drinks or the food is sufficiently cooled, press the COOLMATIC button again. The yellow indicator light goes out. Set the fan regulator to the minimum position.

- i** When this function has been activated, forced air will chill the groceries, and the temperature in the cabinet reset to +2 °C. After 6 hours the COOLMATIC function is ended automatically. The yellow light goes out. Turn the air regulator to its minimum position.

## "Open Door" Warning

If the fridge door is left open for longer than 5 minutes the red warning display will flash and an acoustic warning tone will sound. If you need more time to load or rearrange refrigerated foods, you can switch off the warning tone by pressing the ALARM OFF button. The red warning display will go off when the door is closed.

## Temperature warning

The red warning light flashes and a warning tone sounds, as soon as the temperature in the refrigerator is warmer than 12 °C. Such a rise in temperature can possibly be put down to:

- opening the door a lot or leaving it open for a long time;
- storing larger quantities of warm food;
- a fault with the appliance.

You can turn off the warning tone using the ALARM OFF button.

The warning light and the warning tone switch off automatically, when the ACTUAL temperature existing in the refrigerator drops below 12 °C again.

## Switching the Appliance off

-  1. To switch off, push the ON/OFF button. This will result in a countdown from "3" to "1" taking place in the temperature display. On reaching "1" the fridge will switch off. The temperature display will go off.

 The appliance is only completely disconnected from the electricity supply when the power plug has been removed from the power outlet.

### **Note:**

The appliance cannot be switched on or off if unplugged, or if there is no power being supplied to it.

Following connection to the mains power supply, the appliance returns to the same operating state as before the interruption of main power.

### **If the appliance is not going to be used for an extended period:**

-  1. Switch off the appliance, to do this press the ON/OFF button.
2. Remove the mains plug.
  3. Clean the appliance thoroughly (see section: "Maintenance and Cleaning").
  4. Leave door open to avoid accumulation of odours.

## Holiday Mode

In the holiday mode the temperature for the refrigerator is approximately +15 °C. In the holiday mode it is therefore possible to leave the door of the empty refrigerator closed during periods of extended absence. Advantage: Unintentional closing of the door, or accidental closing of the door by persons who have access to your home during your absence, is no longer possible. Without the holiday mode leaving the door closed would lead to the accumulation of odours and mould.

After emptying and cleaning the appliance, proceed as follows:

1. To set the holiday mode, press the „+“ (WARMER) or „-“ (COLDER) button.

The temperature display will change and indicate in flashing numbers the DESIRED temperature that is currently set.

2. Hold down the „+“ (WARMER) button until the temperature display indicates H (for holiday). The temperature shown in the temperature display will change in steps of 1 °C until it reaches +8 °C. After +8 °C the value +15 °C will appear in the display with the letter H. The fridge is now operating in energy-saving holiday mode.

-  To switch the fridge back to normal operation, press the „-“ (COLDER) button.

**Important!** Do not store any goods in the refrigerator when the holiday mode is in operation. The temperature is regulated at about +15 °C when the holiday mode is in operation. This is too warm for food products.

## Opening the Door

If the door is closed when the appliance is in operation, it cannot be immediately opened again, because a vacuum occurs which holds the door closed until pressure has been equalised. The door can be opened again after several minutes.

# Interior Fittings

## Storage Shelves

The shelf in the lowest runners over the fruit and vegetable drawer must always remain in this position, so that fruit and vegetables stay fresher for longer.

The remaining storage shelves can be adjusted to various heights:

1. Pull the storage shelf forward until it can be tipped up or down and removed.
2. To insert at a different height use the same procedure in reverse.

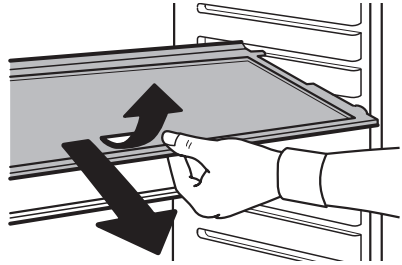

## Salad Bin

The salad bin can be divided into sections by inserting the dividers.

1. Insert the large divider in the middle or to the left side of the salad bin as required.

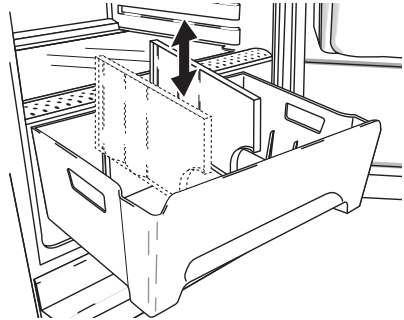

2. If the large divider is inserted in the middle of the bin the right hand side can be further divided by inserting the small divider in the middle or rear position.

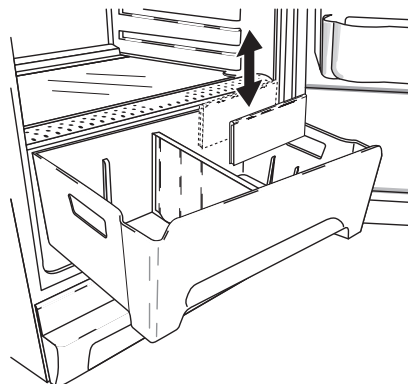

- i** The ventilation grill above the salad bin improves air circulation so that groceries keep for longer.

## Bottle Rack

Place bottles in the rack with the bottleneck to the front.

**Important:** Only store unopened bottles horizontally.

The bottle rack can be tilted for storing opened bottles.

1. To do this pull the bottle rack forward until it can be tilted upwards, then slide the front support into the next level up.

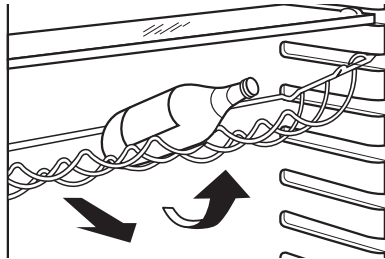
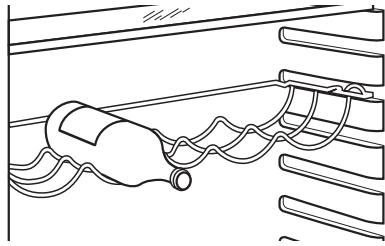

## Quick Chill Shelf

The quick chill shelf can be placed in one of the upper grooves. To maintain the best performance the shelf should be placed in the second groove from the top.

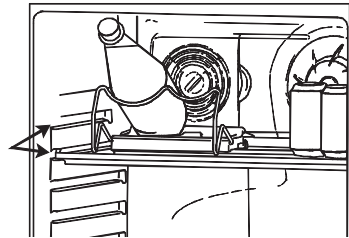

## Bottle and Can Holder

The side of the bottle and can holder is moveable to enable a more flexible placement of cans and bottles in front of the grid. To allow the holder to be moved easier when moving sideways, press the shelf backwards.

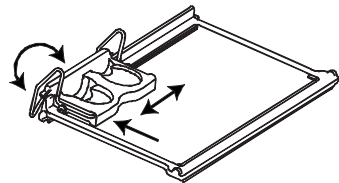



The bottle support can be pulled out when chilling larger bottles.

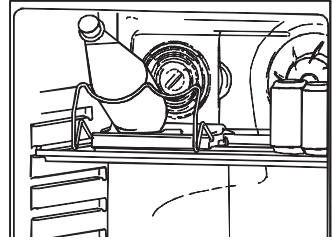

## Dismantling of the Bottle and Can Holder

1. Take out the quick chill shelf with holder from the cabinet.
2. To loosen the holder from the shelf, bend the hooks/brackets that surround the backside of the shelf.

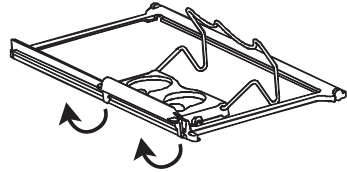

## Variable Inner Door

The door compartments can be pulled up and removed, and inserted at other positions as needed.

## Bottle Holder

A bottle holder in the bottle compartment is used to prevent individual bottles from falling over and can be slid sideways.

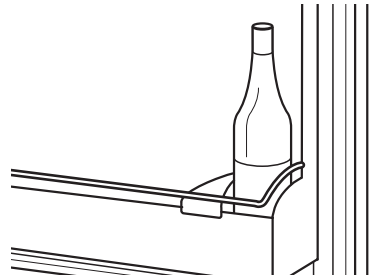

# Proper Storage

The cooling fan ensures an even temperature distribution in the fridge. There is a max. temperature difference of 1 °C. Foods with different lengths of storage time can therefore be arranged on the shelves as you like, without having to take into account the different temperature zones which usually occur. The temperature in the fruit and vegetable drawer is around 3 - 4 °C higher than the fridge temperature set. The example arrangement opposite shows possible ways of storing food. The shelf immediately above the fruit and vegetable tray should be 5 °C for safe storage of meat and fish products. In order to check that the appliance is at 5 °C on the lowest shelf you can carry out the following test yourself:

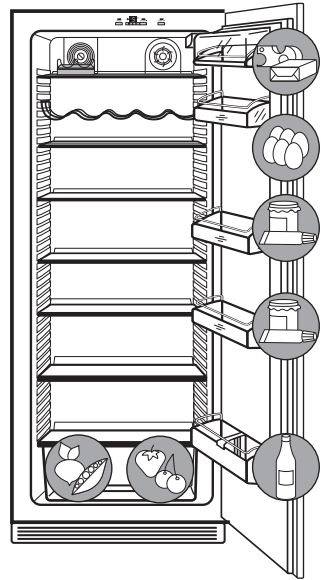

1. Place a cup of water in the centre of the said shelf with a thermometer inside.
  2. Leave the fridge door closed overnight and check the temperature first thing in the morning.
  3. At this point the temperature should read no more than 5 °C; if it does, you need to adjust the temperature to a colder setting.
- Tip: Food stored in the refrigerator compartment should always be covered or packed so that they do not dry out, lose their flavour, or transfer their flavour to any other refrigerated food. The following are suitable for packing:
- polyethylene bags;
  - plastic containers with lids;
  - special plastic covers with rubber retainers;
  - aluminium foil.

---

# Hints and Tips

## Normal Operating Sounds

- You may hear faint gurgling or bubbling sounds when the refrigerant is pumped through the coils or tubing at the rear, to the cooling plate/evaporator.
- When the compressor is on, the refrigerant is being pumped round and you will hear a whirring sound or pulsating noise from the compressor.
- A thermostat controls the compressor and you will hear a faint click when the thermostat cuts in and out.

## Food Storage

To obtain the best performance from your refrigerator:

- Do not store warm food or evaporating liquids.
- Do not store food uncovered.
- Keep the time between buying chilled food and placing it in your refrigerator as short as possible.
- Do not push food together too much, try to allow air to circulate around each item.



## Energy Saving Advice

- Do not install the appliance close to sources of heat, such as a cooker, dishwasher or radiator.
- Locate the appliance in a cool well ventilated room and make sure that the air openings of the appliance are not obstructed.
- Always leave warm food to cool down to room temperature before placing in the fridge.
- Try to avoid keeping the door open for long periods or opening the door too frequently as warm air will enter the cabinet and cause the compressor to switch on unnecessarily often.
- Ensure there are no obstructions preventing the door from closing properly.

# Defrosting

The Fridge defrosts automatically

## Maintenance and Cleaning

Before any maintenance or cleaning work is carried out **DISCONNECT** the appliance from the **ELECTRICITY** supply.

### Internal Cleaning

-  1. Clean the inside and accessories with warm water and bicarbonate of soda (5 ml to 0.5 litre of water). Rinse and dry thoroughly.





#### Warning!

- Do not use detergents, abrasive powders, highly perfumed cleaning products, wax polishes or cleaning products containing bleach or alcohol.
2. Regularly check the door seals and wipe clean to ensure they are clean and free from debris.

### External Cleaning



#### Warning!

- Do not use abrasive products
  - There are sharp edges on the underside of the product so care should be taken when cleaning.
-  1. Clean the appliance with a cloth and lukewarm water with a little mild washing up liquid added. Rinse and dry thoroughly.
-  Accumulation of dust on the condenser reduces cooling performance and increases energy consumption. For this reason carefully clean the condenser at the back of the appliance once a year with a soft brush or a vacuum cleaner.
2. After everything is dry switch the appliance back on.

## Changing the carbon filter

To maintain the best performance the carbon filter should be changed once a year with normal usage.

New carbon filters can be purchased from your local Service Force Centre.

1. The filter is placed behind the grill and can be reached by opening the cover. The cover can be opened by simultaneously pressing the lever on the right of the grill (1) and pulling the cover outward (2).
2. The carbon filter is then pulled out of its slot (3).
3. The new carbon filter is placed in the existing slot.



The filter should be handled carefully so fragments don't loosen from the surface.

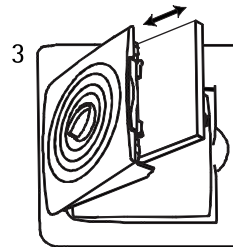
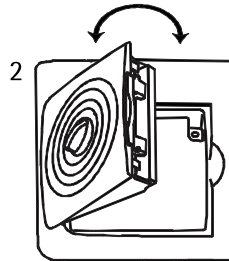
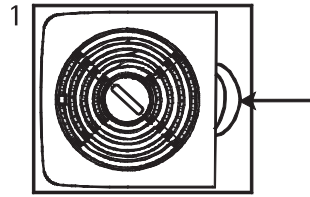

## Replacing the Light Bulb

 **Warning!** Danger of electrical shock! Before replacing the light bulb switch appliance off and remove the mains plug.

Light bulb specifications: 220-240 V, max. 25 W, fitting: E 14

### Important!

When replacing the lamp only fit a lamp of suitable diameter, that is at least 18 mm, this will ensure a good seat on the rubber seal.

Where to purchase: specialist retailer or AEG Service Force Centre.



-  1. To switch the appliance off press the ON/OFF button.
2. Unplug the mains plug.
3. To change the light bulb, undo the cross head screw and remove the light bulb cover downwards.
4. Change the defective light bulb.
5. Refit the light bulb cover and the cross head screw.

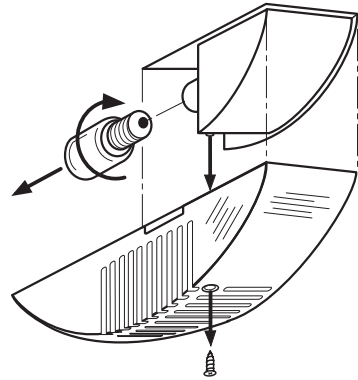

# What to do if ...

Before contacting your local Service Force Centre, check the following points.

Symptom	Solution
No power to the appliance.	Check there is power at the socket
	Check there is not a power cut by checking the household lights.
	Check the fuse has not blown.
The temperature in the refrigerator is too high.	Check the ambient temperature is within the appliances operating limits
	Check the temperature regulator is turned to the correct setting relative to ambient conditions.
Warning tone sounds, red warning display is flashing	Door is opened for longer than 5 minutes Switch off the warning tone by pressing the ALARM OFF button. Do not leave the door open for longer than necessary.
Red warning light flashing, warning tone sounding	Temperature warning Please look at "Temperature warning" section.
Temperature display shows a square or a letter.	There is a function fault. Please inform your local Service Force Centre. Do not open the door of the appliance again.
The compressor runs continuously	Adjust the temperature regulator to give correct temperature control.
	Check that the door is closed.
	Large quantities of food have recently been placed in the cabinet and/or door is frequently opened.
	Check that air ventilation is not obstructed.

Symptom	Solution
The light does not come on.	Ensure the bulb is correctly fitted.
	Replace the bulb if it has blown.
	Check the door light switch is not jammed.
Noise	Refer to Normal Operating Sounds
The compressor does not start immediately after changing the temperature setting.	This is normal, the compressor starts after a period of time.

If after the above checks there is still a fault, call your local AEG Service Force Centre.

In-guarantee customers should ensure that the above checks have been made as the engineer will make a charge if the fault is not a mechanical or electrical breakdown.

Please note that proof of purchase is required for in-guarantee service calls.

## Regulations, Standards, Guidelines

This appliance was designed for household use and was manufactured in accordance with the appropriate standards. The necessary measures in accordance with appliance safety legislation regulations (GSG), accident prevention regulations for refrigeration appliances (VBG 20) and the regulations of the German Society of Electrical Engineers (VDE) were observed in the manufacture of this appliance. The refrigerant circuit has been checked for leaks.

- CE** This appliance is in accordance with the following EU guidelines:
- 73/23/EEG dated 19 February 1973 - low voltage guidelines.
  - 89/336/EEG dated 3 May 1989  
(including guideline change notice 92/31/EEG) - EMV guideline



---

# Technical Terminology

- **Refrigerant**

Liquids that can be used to generate a cooling effect are known as refrigerants. They have a relatively low boiling-point, indeed so low, that the warmth from the food stored in the fridge or freezer can cause the refrigerant to boil and vaporise.

- **Refrigerant Circuit**

Closed circulation system that contains the refrigerant. The refrigerant circuit comprises primarily of an evaporator, a compressor, a condenser and pipe work.

- **Evaporator**

The refrigerant is evaporated in the evaporator. Similar to all other liquids, refrigerant requires heat to evaporate. This heat is removed from the interior of the appliance, as a result the interior is cooled. The evaporator is therefore located inside the appliance or placed in foam immediately behind the inner wall and thus not visible.

- **Compressor**

The compressor looks like a small drum. It is driven by a built-in electric motor and is mounted on the base of the appliance at the rear. The task of the compressor is to draw in vaporised refrigerant from the evaporator, to compress it, and to pass it on to the condenser.

- **Condenser**

The condenser normally has the form of a grid. The refrigerant compressed in the compressor is liquefied in the condenser. During this process, heat is released to the surrounding air at the surface of the condenser. The condenser is mounted on the base of the appliance.

# Guarantee Conditions

AEG offer the following guarantee to the first purchaser of this appliance.

1. The guarantee is valid for 12 months commencing when the appliance is handed over to the first retail purchaser, which must be verified by purchase invoice or similar documentation.

The guarantee does not cover commercial use.

2. The guarantee covers all parts or components which fail due to faulty workmanship or faulty materials. The guarantee does not cover appliances where defects or poor performance are due to misuse, accidental damage, neglect, faulty installation, unauthorised modification or attempted repair, commercial use or failure to observe requirements and recommendations set out in the instruction book.

This guarantee does not cover such parts as light bulbs, removable glassware or plastic, dust bags or filters.

3. Should guarantee repairs be necessary the purchaser must inform the nearest customer service office (manufacturer's service or authorised agent). AEG reserves the right to stipulate the place of the repair (i. e. the customer's home, place of installation or AEG workshop).
4. The guarantee or free replacement includes both labour and materials.
5. Repairs carried out under guarantee do not extend the guarantee period for the appliance. Parts removed during guarantee repairs become the property of AEG.
6. The purchaser's statutory rights are not affected by this guarantee.

## European Guarantee

If you should move to another country within Europe then your guarantee moves with you to your new home subject to the following qualifications:

- The guarantee starts from the date you first purchased your product.
- The guarantee is for the same period and to the same extent for labour and parts as exist in the new country of use for this brand or range of products.
- This guarantee relates to you and cannot be transferred to another user.
- Your new home is within the European Community (EC) or European Free Trade Area.
- The product is installed and used in accordance with our instructions and is only used domestically, i. e. a normal household.
- The product is installed taking into account regulations in your new country.

Before you move please contact your nearest Customer Care Centre, listed below, to give them details of your new home. They will then ensure that the local Service Organisation is aware of your move and able to look after you and your appliances.

France	Senlis	+33 (0) 44 62 29 29
Germany	Nürnberg	+49 (0) 800 234 7378
Italy	Pordenone	+39 (0) 800 117511
Sweden	Stockholm	+46 (0) 8 672 5360
UK	Slough	+44 (0) 1753 219899

# Service & Spare Parts

In the event of your appliance requiring service, or if you wish to purchase spare parts, please contact Service Force by telephoning:

**08705 929 929**

Your telephone call will be automatically routed to the Service Force Centre covering your post code area.

For the address of your local Service Force Centre and further information about Service Force, please visit the website at [www.serviceforce.co.uk](http://www.serviceforce.co.uk)

Before calling out an engineer, please ensure you have read the details under the heading „What to do if.....“

When you contact the Service Force Centre you will need to give the following details:

1. Your name, address and post code.
2. Your telephone number
3. Clear and concise details of the fault.
4. The model and serial number of the appliance (found on the rating plate)

• Model Name



• Model Number (PNC)



• Serial Number (S-No.)



5. The purchase date

Please note that a valid purchase receipt or guarantee documentation is required for in-guarantee service calls.

## Customer Care

For general enquiries concerning your AEG appliance or for further information on AEG products please contact our Customer Care Department by letter or telephone at the address below or visit our website at [www.aeg.co.uk](http://www.aeg.co.uk).

Customer Care Department  
AEG Domestic Appliances  
55-77 High Street  
Slough  
Berkshire, SL1 1DZ  
Tel. 08705 350350 (\*)

**For Customer Service in the Republic of Ireland**  
please contact us at the address below:  
AEG/ Electrolux Group (Ire) Ltd  
Long Mile Road/ Dublin 12  
Republic of Ireland  
Tel: +353 (0) 1 4090751  
Email: [service.eid@electrolux.ie](mailto:service.eid@electrolux.ie)

(\*) Calls may be recorded for training purposes

 **From the Electrolux Group. The world's No. 1 choice.**

*The Electrolux Group is the world's largest producer of powered appliances for kitchen, cleaning and outdoor use. More than 55 million Electrolux Group products (such as refrigerators, cookers, washing machines, vacuum cleaners, chain saws and lawn mowers) are sold each year to a value of approx. USD 14 billion in more than 150 countries around the world.*

AEG Hausgeräte GmbH  
Postfach 1036  
D-90327 Nürnberg

<http://www.aeg.hausgeraete.de>

© Copyright by AEG

818 3328 – 00/7 – 0604

Subject to change without notice