

KENWOOD

KDC-MPV7020

KDC-6020

KDC-5020

KDC-5020R

CD-RECEIVER

INSTRUCTION MANUAL

KENWOOD CORPORATION



© B64-2244-00 (M)

Contents

Safety precautions.....3	Tuner features	Switching Graphic Display
About CDs.....5	(KDC-MPV7020/6020/5020) ...17	Contrast Adjustment
Notes on playing MP36	Tuning Mode	Dimmer
General features8	Tuning	Switching preout
Power	Direct Access Tuning	News Bulletin with Timeout Setting
Selecting the Source	Station Preset Memory	Local Seek
Volume	Auto Memory Entry	Tuning Mode
Attenuator	Preset Tuning	Auto Memory Entry
Loudness	Frequency Step Setting	CRSC (Clean Reception System Circuit)
System Q	CD/MP3/External disc control	AF (Alternative Frequency)
Audio Control	features20	Restricting RDS Region
Speaker Setting	Playing CD & MP3	(Region Restrict Function)
Switching Display	Playing External Disc	Auto TP Seek
Station/Disc Naming (SNPS/DNPS)	Fast Forwarding and Reversing	Monaural Reception
TEL Mute	Track Search	Text Scroll
Auxiliary Input Display Setting	Album Search	Built-in Auxiliary input Setting
Non-fading Output	Direct Track Search	Basic Operations of remote.....30
Theft Deterrent Faceplate	Direct Album Search	Accessories
Tuner features (KDC-5020R)..... 13	Track/Album Repeat	(KDC-MPV7020/6020/5020) ...32
Tuning	Track Scan	Installation Procedure
Direct Access Tuning	Random Play	(KDC-MPV7020/6020/5020) ...32
Station Preset Memory	Magazine Random Play	Connecting Wires to Terminals
Auto Memory Entry	Album Select	(KDC-MPV7020/6020/5020) ...33
Preset Tuning	Text/Title Scroll	Accessories (KDC-5020R).....34
RDS features 15	DNPP (Disc Name Preset Play)	Installation Procedure
Traffic Information	Menu system.....24	(KDC-5020R).....34
Radio Text Scroll	Menu System	Connecting Wires to Terminals
PTY (Program Type)	Security Code	(KDC-5020R).....35
Program Type preset	Touch Sensor Tone	Installation37
Changing Language for PTY Function	Manual Clock Adjustment	Troubleshooting Guide39
	Synchronize Clock	Specifications43
	DSI (Disabled System Indicator)	
	Selectable Illumination	
	Switching Display Type	
	Illumination Color Setting	

Safety precautions

▲WARNING

To prevent injury or fire, take the following precautions:

- Insert the unit all the way in until it is fully locked in place. Otherwise it may fall out of place when jolted.
- When extending the ignition, battery, or ground wires, make sure to use automotive-grade wires or other wires with a 0.75mm² (AWG18) or more to prevent wire deterioration and damage to the wire coating.
- To prevent a short circuit, never put or leave any metallic objects (such as coins or metal tools) inside the unit.
- If the unit starts to emit smoke or strange smells, turn off the power immediately and consult your Kenwood dealer.
- Make sure not to get your fingers caught between the faceplate and the unit.
- Be careful not to drop the unit or subject it to strong shock.
The unit may break or crack because it contains glass parts.
- Do not touch the liquid crystal fluid if the LCD is damaged or broken due to shock. The liquid crystal fluid may be dangerous to your health or even fatal.
If the liquid crystal fluid from the LCD contacts your body or clothing, wash it off with soap immediately.

▲CAUTION

To prevent damage to the machine, take the following precautions:

- Make sure to ground the unit to a negative 12V DC power supply.
- Do not open the top or bottom covers of the unit.
- Do not install the unit in a spot exposed to direct sunlight or excessive heat or humidity. Also avoid places with too much dust or the possibility of water splashing.
- Do not subject the faceplate to excessive shock, as it is a piece of precision equipment.
- When replacing a fuse, only use a new one with the prescribed rating. Using a fuse with the wrong rating may cause your unit to malfunction.
- To prevent a short circuit when replacing a fuse, first disconnect the wiring harness.
- Do not place any object between the faceplate and the unit.
- Do not use your own screws. Use only the screws provided. If you use the wrong screws, you could damage the unit.
- Do not apply excessive force to the open faceplate or place objects on it. Doing so will cause damage or breakdown.

Do Not Load 3-in. CDs in the CD slot

If you try to load a 3 in. CD with its adapter into the unit, the adapter might separate from the CD and damage the unit.

IMPORTANT INFORMATION

About the disc changer/CD player to be connected:

To connect a disc changer having the "O-N" switch to this unit, set the "O-N" switch to "N". To connect a disc changer having no "O-N" switch to this unit, the converter cord CA-DS100 and/or switching adapter KCA-S210A are required as options.

A disc changer doesn't work when it is connected without using these options. If a model with no "O-N" switch is connected, some unavailable functions and information that cannot be displayed are generated. Note that none of the KDC-C100, KDC-C302, C205, C705, and non-Kenwood CD changers can be connected.



You can damage both your unit and the CD changer if you connect them incorrectly.

**The marking of products using lasers
(Except for some areas)**

**CLASS 1
LASER PRODUCT**

The label is attached to the chassis/case and says that the component uses laser beams that have been classified as Class 1. It means that the unit is utilizing laser beams that are of a weaker class. There is no danger of hazardous radiation outside the unit.

Safety precautions

NOTE

- If you experience problems during installation, consult your Kenwood dealer.
- If the unit fails to operate properly, press the Reset button. The unit returns to factory settings when the Reset button is pressed. If the unit still fails to operate properly after the Reset button has been pressed, contact your local KENWOOD dealer for assistance.
- Press the reset button if the disc auto changer fails to operate correctly. Normal operation should be restored.

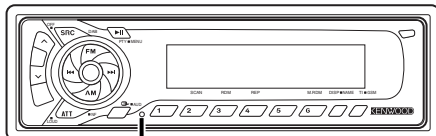

Reset button

- We recommend the use of the Security Code function (see p. 24) to prevent theft.
- Characters in the LCD may become difficult to read in temperatures below 41 °F (5 °C).
- The illustrations of the display and the panel appearing in this manual are examples used to explain more clearly how the controls are used. Therefore, what appears on the display in the illustrations may differ from what appears on the display on the actual equipment, and some of the illustrations on the display may represent something impossible in actual operation.

Lens Fogging

Right after you turn on the car heater in cold weather, dew or condensation may form on the lens in the CD player of the unit. Called lens fogging, CDs may be impossible to play. In such a situation, remove the disc and wait for the condensation to evaporate. If the unit still does not operate normally after a while, consult your Kenwood dealer.

Cleaning the Faceplate Terminals

If the terminals on the unit or faceplate get dirty, wipe them with a dry, soft cloth.

Cleaning the Unit

If the faceplate of this unit is stained, wipe it with a dry soft cloth such as a silicon cloth. If the faceplate is stained badly, wipe the stain off with a cloth moistened with neutral cleaner, then wipe neutral detergent off.



Applying spray cleaner directly to the unit may affect its mechanical parts. Wiping the faceplate with a hard cloth or using a volatile liquid such as thinner or alcohol may scratch the surface or erases characters.

Cleaning the CD Slot

As dust tends to accumulate in the CD slot, clean it every once in a while. Your CDs can get scratched if you put them in a dusty CD slot.

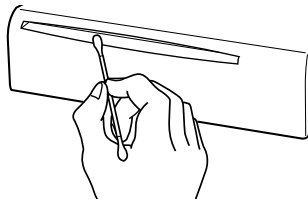

About RDS

RDS (Radio Data System)

When listening to an RDS station, the programme service name of the station is displayed, advising you quickly which station is being received.

RDS (Radio Data System) stations also transmit frequency data for the same station. When you are making long trips, this function automatically alternative switches to the particular frequency with the best reception for the particular network of stations that you want to listen to. The data is automatically stored, allowing you to switch quickly to another RDS stations, broadcasting the same programme, that has better reception. These include stations stored in the station preset memory that you often listen to.

Enhanced Other Network

Stations that offer <Enhanced Other Network> also transmit information about other RDS stations that have traffic information. When you are tuned to a station that is not transmitting traffic information, but another RDS station starts transmitting a traffic bulletin, the tuner automatically switches to the other station for the duration of the bulletin.

Alarm

When an emergency transmission (announcing disasters, etc.) is sent, all current functions are interrupted to allow the warning to be received.

About CDs

Handling CDs

- Don't touch the recording surface of the CD.

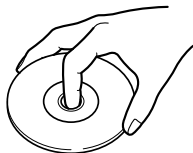

- CD-R and CD-RW are easier to damage than a normal music CD. Use a CD-R or a CD-RW after reading the caution items on the package etc.
- Don't stick tape etc. on the CD. Also, don't use a CD with tape stuck on it.

When using a new CD

If the CD center hole or outside rim has burrs, use it after removing them with a ball pen etc.

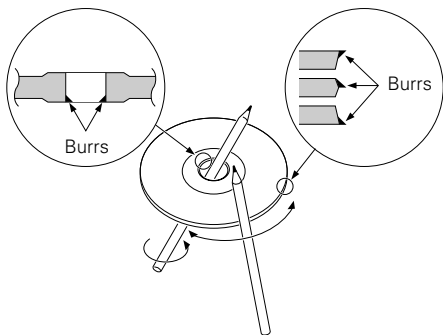

CD accessories

Don't use disc type accessories.

CD cleaning

Clean from the center of the disc and move outward.

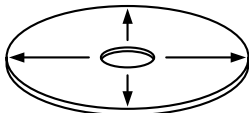



Removing CDs

When removing CDs from this unit pull them out horizontally.

CDs that can't be used

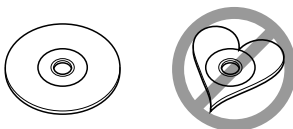
- CDs that aren't round can't be used.



- CDs with coloring on the recording surface or that are dirty can't be used.
 - Don't use CDs without disc mark
- 
- A CD-R or CD-RW that hasn't been finalized can't be played. (For the finalization process refer to your CD-R/CD-RW writing software, and your CD-R/CD-RW recorder instruction manual.)

CD storage

- Don't place them in direct sunlight (On the seat or dashboard etc.) and where the temperature is high.
- Store CDs in their cases.

Notes on playing MP3

This unit can play MP3(MPEG1, 2, 2.5 Audio Layer 3). Note, however, that the MP3 recording media and formats acceptable are limited. When writing MP3, pay attention to the following restrictions.

Acceptable media

The MP3 recording media acceptable to this unit are CD-ROM, CD-R, and CD-RW.

When using CD-RW, do full format not quick format to prevent malfunction.

Acceptable medium formats

The following formats are available for the media used in this unit. The maximum number of characters used for file name including the delimiter (".") and three-character extension are indicated in parentheses.

- ISO 9660 Level 1 (12 characters)
- ISO 9660 Level 2 (31 characters)
- Joliet (64 characters)
- Romeo (128 characters)

Up to 200 characters can be displayed in the long file name format. For a list of available characters, see the instruction manual of the writing software and the section Entering file and folder names below. The media reproducible on this unit has the following limitations:

- Maximum number of directory levels: 8
- Maximum number of files per folder: 255
- Maximum number of characters for folder name: 64
- Maximum number of folders: 50

MP3 written in the formats other than the above may not be successfully played and their file names or folder names are not properly displayed.

Settings for your MP3 encoder and CD writer

When you use your CD writer to record MP3 up to the maximum disc capacity, disable additional writing. For recording on an empty disc up to the maximum capacity at once, check Disc at Once.

Entering ID3 tag

The Displayable ID3 tag is ID3 version 1.x.

For the character code, refer to the List of Codes.

Entering file and folder names

The code list characters are the only file names and folder names that can be entered and displayed.

If you use any other character for entry, the file and folder names are not displayed correctly. They may neither be displayed correctly depending on the CD writer used. The unit recognizes and plays only those MP3 which have the MP3 extension (.MP3).



A file with a name entered with characters not on the code list may not play correctly.

Writing files into a medium

When a medium containing MP3 data is loaded, the unit checks all the data on the medium. If the medium contains a lot of folders or non-MP3 files, therefore, it takes a long time until the unit starts playing MP3.

In addition, it may take time for the unit to move to the next MP3 file or a Track Search or Album Search may not be performed smoothly.



Loading such a medium may produce loud noise to damage the speakers.

- Do not attempt to play a medium containing a non-MP3 file with the MP3 extension.
The unit mistakes non-MP3 files for MP3 data as long as they have the MP3 extension.
- Do not attempt to play a medium containing non MP3.

0	1	2	3	4	5	6	7	8	9	A	B	C	D	E	F
0				0	@	P	'	p		■	°	A	D	à	d
1				1	A	Q	a	q		i	±	A	N	á	n
2				2	B	R	b	r		e	²	A	O	â	o
3				#	3	C	S	c	s		£	³	A	Ó	ã
4				\$	4	D	T	d	t		¤	⁴	A	Ô	ä
5				%	5	E	U	e	u		¥	µ	A	Õ	å
6				&	6	F	V	f	v		¦	¶	O	ö	ø
7				'	7	G	W	g	w		§	-	C	X	ç
8				(8	H	X	h	x		¨	±	E	O	è
9)	9	I	Y	i	y		©	¹	E	Ü	é
A				*	:	J	Z	j	z		ª	²	A	U	ú
B				+	:	K	{	k	{		»	³	E	Ü	û
C				<	<	L	\	l	\		¼	1	Ü	ü	
D				-	=	M		m			½	2	Y	y	
E				.	>	N	^	n	~		¾	3	P	p	
F				/	?	O	_	o	_		¸	4	I	P	i

MP3 playing order

When selected for play, Album Search, Track Search, or for Album Select, files and folders are accessed in the order in which they were written by the CD writer.

Because of this, the order in which they are expected to be played may not match the order in which they are actually played. You may be able to set the order in which MP3 are to be played by writing them onto a medium such as a CD-R with their file names beginning with play sequence numbers such as "01" to "99", depending on your CD writer.

For example, a medium with the following folder/ file hierarchy is subject to Album Search, Track Search, or Album Select as shown below.

Example of a medium's folder/file hierarchy

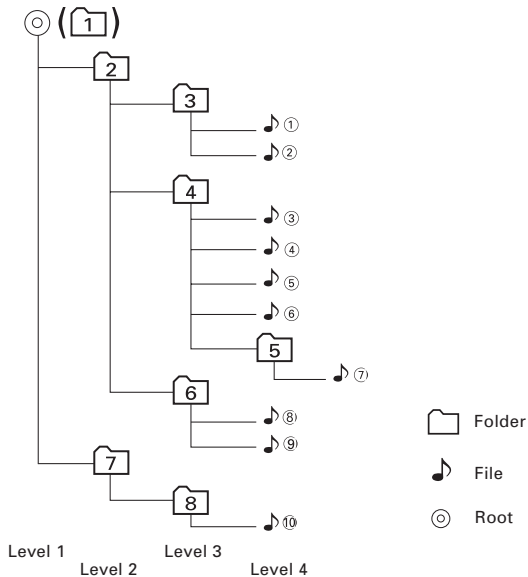

When a Track Search is executed with file ④ being played ...

Current file number	Operation of the button	
	◀◀ Button	▶▶ Button
④	Beginning of file ④ ▶ ③	⑤ ▶ ⑥

When an Album Search is executed with file ④ being played ...

Current folder number	Operation of the button	
	AM Button	FM Button
④	③ ▶ ② ▶ ① ▶ ⑧ ...	⑤ ▶ ⑥ ▶ ⑦ ▶ ⑧ ▶ ① ...

When Album Select is selected with file ④ being played to move from folder to folder ...

Current folder number	Operation of the button			
	◀◀ Button	▶▶ Button	AM Button	FM Button
④	③	⑥	②	⑤

General features

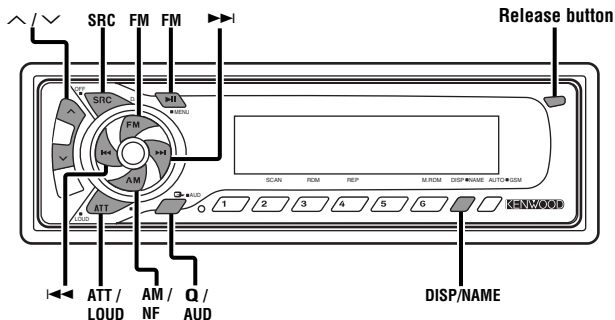

KDC-MPV7020/6020

ATT indicator

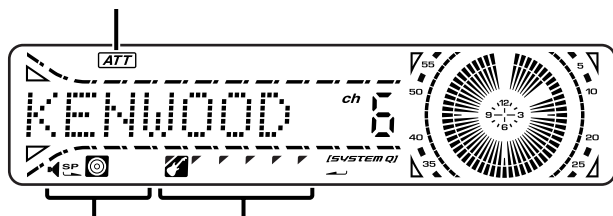

Speaker Setting indicator

SYSTEM Q indicator

KDC-5020/5020R

ATT indicator

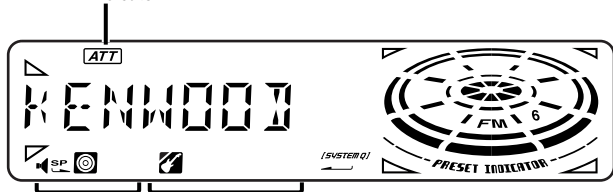

Speaker Setting indicator

SYSTEM Q indicator

Power

Turning ON the Power

Press the [SRC] button.



When the power is ON, the <Security Code> (page 24) is displayed as "CODE ON" or "CODE OFF".

Turning OFF the Power

Press the [SRC] button for at least 1 second.

Selecting the Source

Press the [SRC] button.

Source required	Display
Tuner	"TUNER"
CD	"CD"
External disc	"DISC-CH"/"CD2"
Auxiliary input	"AUX"
Standby (Illumination only mode)	"ALL OFF"



For Auxiliary input one of the below optional accessories is necessary.

- KCA-S210A
- CA-C1AX
- CD changer with an Auxiliary input function installed.

Volume

Increasing Volume

Press the [^] button.

Decreasing Volume

Press the [v] button.

Attenuator

Turning the volume down quickly.

Press the [ATT] button.

Each time the button is pressed the Attenuator turns ON or OFF. When it's ON, the "ATT" indicator blinks.

Loudness

Compensating for low and high tones during low volume.

Press the [LOUD] button for at least 1 second.

Each time the button is pressed for at least 1 second the Loudness turns ON or OFF. When it's ON, "LOUD ON" is displayed.

System Q

You can recall the best sound setting preset for different types of the music.

1 Select the source to set

Press the [SRC] button.

2 Select the Sound type

Press the [Q] button.

Each time the button is pressed the sound setting switches.

Sound setting	Display
Flat	"Flat"/ "FLAT"
User memory	"User"/ "USER"
Rock	"Rock"/ "ROCK"
Pops	"Pops"/ "POPS"
Easy	"Easy"/ "EASY"
Top 40	"Top40"/ "TOP40"
Jazz	"Jazz"/ "JAZZ"



- User memory: The values set on the <Audio control> (page 9).
- Each setting value is changed with the <Speaker setting> (page 10).

First, select the speaker type with the Speaker setting.

Audio Control

1 Select the source for adjustment

Press the [SRC] button.

2 Enter Audio Control mode

Press the [AUD] button for at least 1 second.

3 Select the Audio item for adjustment

Press the [FM] or [AM] button.

Each time the button is pressed the items that can be adjusted switch as shown below.

4 Adjust the Audio item

Press the [◀◀] or [▶▶] button.

Adjustment Item	Display	Range
Bass level	"Bas"/"BAS"	-8 — +8
Middle level	"Mid"/"MID"	-8 — +8
Treble level	"Tre"/"TRE"	-8 — +8
Balance	"Bal"/"BAL"	Left 15 — Right 15
Fader	"Fad"/"FAD"	Rear 15 — Front 15
Volume offset	"V-OFF"	-8 — ±0



Volume offset: Each source's volume can be set as a difference from the basic volume.

5 Exit Audio Control mode

Press the [AUD] button.

General features

Speaker Setting

Fine-tuning so that the System Q value is optimal when setting the speaker type.

1 Enter Standby

Press the [SRC] button.
Select the "ALL OFF" display.

2 Enter Speaker Setting mode

Press the [Q] button.

3 Select the Speaker type

Press the [◀◀] or [▶▶] button.
Each time the button is pressed the setting switches as shown below.

Speaker type	Display
OFF	"SP OFF"
For 5 & 4 in. speaker	"SP 5/4"
For 6 & 6x9 in. speaker	"SP 6*9/6"
For the OEM speaker	"SP OEM"

4 Exit Speaker Setting mode

Press the [Q] button.

Switching Display

Switching the information displayed.

Press the [DISP] button.
Each time the button is pressed the display switches as shown below.

In Tuner source

Information	Display
Frequency (KDC-MPV7020/6020/5020 only)	
Station name (KDC-MPV7020/6020/5020 only)	"SNPS"
Program Service name or Frequency (KDC-5020R only)	
Radio text (KDC-5020R only)	"R-TEXT"
Clock	

The frequency is displayed during Program Service name reception (KDC-5020R only)

Press the [DISP] button for at least 1 second.

The frequency for the RDS station will be displayed for 5 seconds instead of the Program Service name.

In CD & External disc source

KDC-MPV7020/6020 :

Information	Display
Track number	
Disc name	"DNPS"
Disc title (In External disc source or KDC-MPV7020 internal CD source)	"D-TITLE"
Track title (In External disc source or KDC-MPV7020 internal CD source)	"T-TITLE"
Track number & Track Time	
Clock	

KDC-5020/5020R :

Information	Display
Track number & Track Time	
Disc name	"DNPS"
Disc title (In External disc source)	"D-TITLE"
Track title (In External disc source)	"T-TITLE"
Clock	

In MP3 source

Information	Display
Track number	
Disc name	"DNPS"
Folder name	"FOL NAME"
File name	"FIL NAME"
Song title & Artist name	"TITLE"
Album name & Artist name	"ALBUM"
Track Time	
Clock	

Station/Disc Naming (SNPS/DNPS)

Attaching a title to a Station (KDC-MPV7020/6020/5020 only) or CD.

1 Receive/play the station/disc you want to attach a title to

- A title can't be attached to a MD.
KDC-MPV7020/6020:
- Disc Naming can't be done during CD text display.
KDC-5020/5020R:
- Disc Naming can't be done during CD text or clock display.

2 Enter name set mode

Press the [NAME] button for at least 2 seconds.
"NAME SET" is displayed.

3 Move the cursor to the enter character position

Press the [◀◀] or [▶▶] button.

4 Select the character type (KDC-MPV7020/6020 only)

Press the [▶II] button.
Each time the button is pressed the character type switches as shown below.

Character type

Alphabet upper case

Alphabet lower case

Numbers and symbols

Special characters (Accent characters)

5 Select the characters

Press the [FM] or [AM] button.

- Characters can be entered by using a remote with a number buttons.
Example: If "DANCE" is entered.

Character	Button	#Times pressed
"D"	[#3]	1
"A"	[#2]	1

"N"	[#6]	2
"C"	[#2]	3
"E"	[#3]	2

6 Repeat steps 3 through 5 and enter the name.

7 Exit name set mode

Press the [NAME] button.

- When operation stops for 10 seconds the name at that time is registered, and Name Set mode closes.
- Memory numbers
 - FM: 32 stations
 - AM: 16 stations
 - Internal CD player: 30 (KDC-MPV7020/6020)/10 (KDC-5020/5020R) discs
 - External CD changer/ player: Varies according to the CD changer/ player. Refer to the CD changer/ player manual.
- The title of station/CD can be changed by the same operation used to name it.

Function of the KDC-5020R

TEL Mute

The audio system automatically mutes when a call comes in.

When a call comes in

"CALL" is displayed.

The audio system pauses.

Listening to the audio during a call

Press the [SRC] button.

The "CALL" display disappears and the audio system comes back ON.

When the call ends

Hang up the phone.

The "CALL" display disappears and the audio system comes back ON.

General features

Auxiliary Input Display Setting

Selecting the display when this device is switched to Auxiliary input source.

1 Select Auxiliary input source

Press the [SRC] button.
Select the "AUX" display.

2 Enter Auxiliary input display setting mode

Press the [DISP] button for at least 2 seconds.
The presently selected AUX Name is blinks.

3 Select the Auxiliary input display

Press the [◀◀] or [▶▶] button.
Each time the button is pressed it switches through the below displays.

- "AUX"
- "TV"
- "VCP"
- "GAME"
- "PORTABLE"
- "DVD"

4 Exit Auxiliary input display setting mode

Press the [DISP] button.



- When operation stops for 10 seconds, the name at that time is selected, and Auxiliary input display setting mode closes.
KDC-5020/5020R:
- This function doesn't work when CA-C1AX is used.

Function of the KDC-MPV7020/KDC-6020

Non-fading Output

Turning the Non-fading output ON or OFF.

Press the [NF] button for at least 1 second.

Each time the button is pressed Non-fading output switches ON or OFF.

When it's ON, "NF ON" is displayed.

Theft Deterrent Faceplate

The faceplate of the unit can be detached and taken with you, helping to deter theft.

Removing the Faceplate

- 1 Press the Release button.
Drop open the faceplate.
- 2 Drawing the faceplate to left side pull it to the front and remove it.

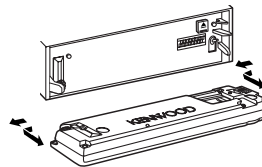

- The faceplate is a precision piece of equipment and can be damaged by shocks or jolts. For that reason, keep the faceplate in its special storage case while detached.
- Do not expose the faceplate or its storage case to direct sunlight or excessive heat or humidity. Also avoid places with too much dust or the possibility of water splashing.

Reattaching the Faceplate

- 1 Align the shaft on the unit with the depression on the faceplate.

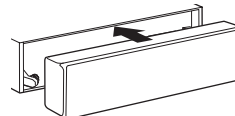

- 2 Push the faceplate in until it clicks.
The faceplate is locked in place, allowing you to use the unit.

Tuner features

Function of the KDC-5020R

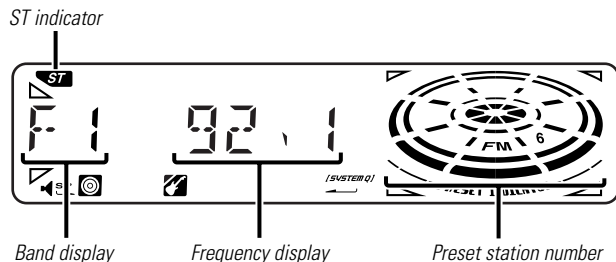
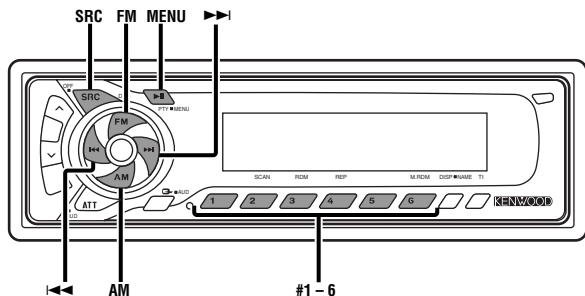

Tuning

Selecting the station.

1 Select tuner source

Press the [SRC] button.

Select the "TUNER" display.

2 Select the band

Press the [FM] or [AM] button.

Each time the [FM] button is pressed it switches between the FM1, FM2, and FM3 bands.

3 Tune up or down band

Press the [◀◀] or [▶▶] button.



During reception of stereo stations the "ST" indicator is ON.

Direct Access Tuning (Function of remote)

Entering the frequency and tuning.

1 Select the band

Press the [FM] or [AM] button.

2 Enter Direct Access Tuning mode

Press the [DIRECT] button on the remote.

"- - - -" is displayed.

3 Enter the frequency

Press the number buttons on the remote.

Example:

Desired frequency

Press button

92.1 MHz (FM) [#0], [#9], [#2], [#1]

810 kHz (AM) [#0], [#8], [#1], [#0]

Canceling Direct Access Tuning

Press the [DIRECT] button on the remote.

Tuner features

Function of the KDC-5020R

Station Preset Memory

Putting the station in the memory.

1 Select the band

Press the [FM] or [AM] button.

2 Select the frequency to put in the memory

Press the [◀◀] or [▶▶] button.

3 Put the frequency in the memory

Press the [#1] — [#6] button for at least 2 seconds.

The preset number display blinks 1 time.

On each band, 1 station can be put in the memory on each [#1]

— [#6] button.

Auto Memory Entry

Putting a station with good reception in the memory automatically.

1 Select the band for Auto Memory Entry

Press the [FM] or [AM] button.

2 Enter Menu mode

Press the [MENU] button for at least 1 second.

"MENU" is displayed.

3 Select the Auto Memory Entry mode

Press the [FM] or [AM] button.

Select the "A-MEMORY" display.

4 Open Auto Memory Entry

Press the [◀◀] or [▶▶] button for at least 2 seconds.

When 6 stations that can be received are put in the memory

Auto Memory Entry closes.



- When the <AF Function> (page 29) is ON, only RDS stations are put in the memory.

- When Auto Memory Entry is done in the FM2 band, the RDS stations preset in the FM1 band aren't put in the memory. Likewise, when it is done in the FM3 band, RDS stations preset in FM1 or FM2 aren't put in the memory.

Preset Tuning

Calling up the stations in the memory.

1 Select the band

Press the [FM] or [AM] button.

2 Call up the station

Press the [#1] — [#6] button.

RDS features

Function of the KDC-5020R

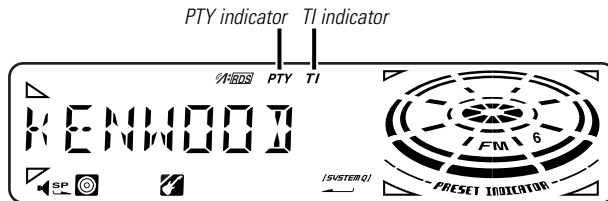
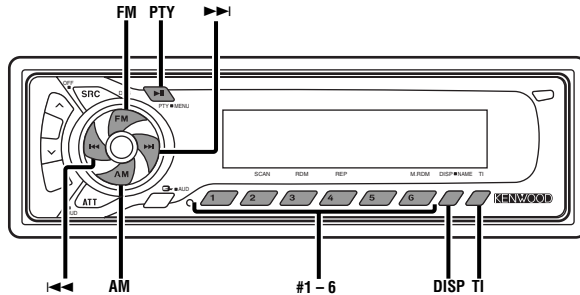

Traffic Information

Switching to traffic information automatically when a traffic bulletin starts even when you aren't listening to the radio.

Press the [TI] button.

Each time the button is pressed the Traffic Information function turns ON or OFF.

When it's ON, "TI" indicator is ON.

When a traffic information station isn't being received the "TI" indicator blinks.

When a traffic bulletin starts, "TRAFFIC" is displayed and it switches to traffic information.

- During reception of an AM station when the Traffic Information function is turned ON, it switches to a FM station.
- During reception of traffic information the adjusted volume is automatically remembered, and the next time it switches to traffic information it's automatically the remembered volume.

Receiving other traffic information stations

Press the [◀◀] or [▶▶] button.

- Traffic information station switching can be done when listening to the radio.

Radio Text Scroll

Scrolling the displayed radio text.

Press the [DISP] button for at least 1 second.

RDS features

Function of the KDC-5020R

PTY (Program Type)

Selecting the Program Type and searching for a station.

1 Enter PTY mode

Press the [PTY] button.

During PTY mode the "PTY" indicator is ON.



This function can't be used during a traffic bulletin or AM reception.

2 Select the Program Type

Press the [FM] or [AM] button.

Each time the button is pressed the Program Type switches as shown below.

No.	Program Type	Display
1.	Speech	"SPEECH"
2.	Music	"MUSIC"
3.	News	"NEWS"
4.	Current Affairs	"AFFAIRS"
5.	Information	"INFO"
6.	Sport	"SPORT"
7.	Education	"EDUCATE"
8.	Drama	"DRAMA"
9.	Culture	"CULTURE"
10.	Science	"SCIENCE"
11.	Varied	"VARIED"
12.	Pop Music	"POP M"
13.	Rock Music	"ROCK M"
14.	Easy Listening Music	"EASY M"
15.	Light Classical	"LIGHT M"
16.	Serious Classical	"CLASSICS"
17.	Other Music	"OTHER M"
18.	Weather	"WEATHER"
19.	Finance	"FINANCE"
20.	Children's programs	"CHILDREN"

21.	Social Affairs	"SOCIAL"
22.	Religion	"RELIGION"
23.	Phone In	"PHONE IN"
24.	Travel	"TRAVEL"
25.	Leisure	"LEISURE"
26.	Jazz Music	"JAZZ"
27.	Country Music	"COUNTRY"
28.	National Music	"NATION M"
29.	Oldies Music	"OLDIES"
30.	Folk Music	"FOLK M"
31.	Documentary	"DOCUMENT"



• Speech and Music include the Program type shown below.

Music: No.12 — 17, 26 — 30

Speech: No.3 — 11, 18 — 25, 31

• The Program Type can be put in the [#1] — [#6] button memory and called up quickly. Refer to the <Program Type preset> (page 16).

• The display language can be changed. Refer to <Changing Language for PTY Function> (page 17).

3 Search for the selected Program Type station

Press the [◀◀] or [▶▶] button.

When you want to search for other stations press the [◀◀] or [▶▶] button again.



When the selected Program Type isn't found, "NO PTY" is displayed.

Select another Program Type.

4 Exit PTY mode

Press the [PTY] button.

Program Type preset

Putting the Program Type in the Preset button memory and calling it up quickly.

Presetting the Program Type

1 Select the Program Type to preset

Refer to <PTY(Program Type)> (page 16).

2 Preset the Program Type

Press the [#1] — [#6] button for at least 2 seconds.

Calling up the preset Program Type

1 Enter PTY mode

Refer to <PTY(Program Type)> (page 16).

2 Call up the Program Type

Press the [#1] — [#6] button.

Changing Language for PTY Function

Selecting the Program Type display language.

1 Enter PTY mode

Refer to <PTY (Program Type)> (page 16).

2 Enter Changing Language mode

Press the [DISP] button.

3 Select the language

Press the [FM] or [AM] button.

Each time the button is pressed the language switches as shown below.

Language	Display
English	"ENGLISH"
French	"FRENCH"
Swedish	"SWEDISH"
German	"GERMAN"

4 Exit Changing Language mode

Press the [DISP] button.

Tuner features

Function of the KDC-MPV7020/KDC-6020/KDC-5020

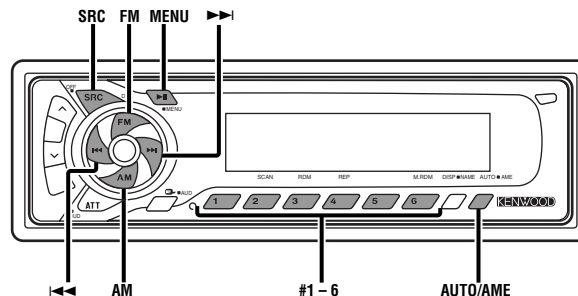

KDC-MPV7020/6020

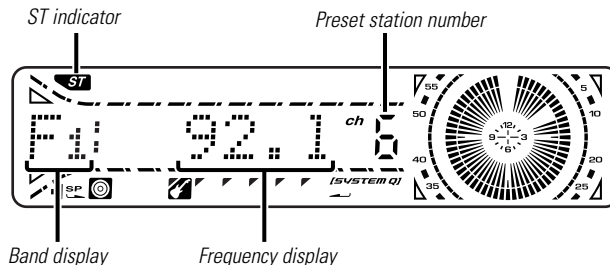

KDC-5020

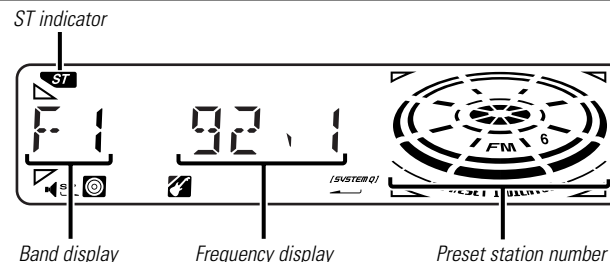

Tuner features

Function of the KDC-MPV7020/KDC-6020/KDC-5020

Tuning Mode

Choose the tuning mode.

Press the [AUTO] button.

Each time the button is pressed the Tuning mode switches as shown below.

Tuning mode	Display	Operation
Auto seek	"Auto 1"/ "AUTO 1"	Automatic search for a station.
Preset station seek	"Auto 2"/ "AUTO 2"	Search in order of the stations in the Preset memory.
Manual	"Manual"/ "MANUAL"	Normal manual tuning control.

Tuning

Selecting the station.

1 Select tuner source

Press the [SRC] button.

Select the "TUNER" display.

2 Select the band

Press the [FM] or [AM] button.

Each time the [FM] button is pressed it switches between the FM1, FM2, and FM3 bands.

3 Tune up or down band

Press the [◀◀] or [▶▶] button.



During reception of stereo stations the "ST" indicator is ON.

Direct Access Tuning (Function of remote)

Entering the frequency and tuning.

1 Select the band

Press the [FM] or [AM] button.

2 Enter Direct Access Tuning mode

Press the [DIRECT] button on the remote.

"- - - -" is displayed.

3 Enter the frequency

Press the number buttons on the remote.

Example:

Desired frequency	Press button
92.1 MHz (FM)	[#0], [#9], [#2], [#1]
810 kHz (AM)	[#0], [#8], [#1], [#0]

Canceling Direct Access Tuning

Press the [DIRECT] button on the remote.

Station Preset Memory

Putting the station in the memory.

1 Select the band

Press the [FM] or [AM] button.

2 Select the frequency to put in the memory

Press the [◀◀] or [▶▶] button.

3 Put the frequency in the memory

Press the [#1] — [#6] button for at least 2 seconds.

The preset number display blinks 1 time.

On each band, 1 station can be put in the memory on each [#1]

— [#6] button.

Function of the KDC-MPV7020/KDC-6020

Auto Memory Entry

Putting a station with good reception in the memory automatically.

1 Select the band for Auto Memory Entry

Press the [FM] or [AM] button.

2 Enter Menu mode

Press the [MENU] button for at least 1 second.
"MENU" is displayed.

3 Select the Auto Memory Entry mode

Press the [FM] or [AM] button.
Select the "A-Memory" display.

4 Open Auto Memory Entry

Press the [◀◀] or [▶▶] button for at least 2 seconds.
When 6 stations that can be received are put in the memory
Auto Memory Entry closes.

Preset Tuning

Calling up the stations in the memory.

1 Select the band

Press the [FM] or [AM] button.

2 Call up the station

Press the [#1] — [#6] button.

Frequency Step Setting

Changing the tuning frequency step.

The original setting is FM band 50 kHz, and AM band 9 kHz.

While pressing the [#1] and [#5] button, press the Reset button.

The frequency step changes to FM band 200 kHz, and AM band 10 kHz.



When the frequency step is switched, the frequencies in the memory are deleted.

Function of the KDC-5020

Auto Memory Entry

Putting stations with good reception in the memory automatically.

1 Select the band for Auto Memory Entry

Press the [FM] or [AM] button.

2 Open Auto Memory Entry

Press the [AME] button for at least 2 seconds.
When 6 stations that can be received are put in the memory
Auto Memory Entry closes.

CD/MP3/External disc control features

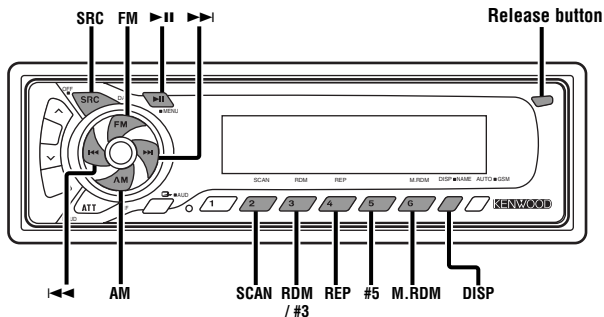

KDC-MPV7020/6020

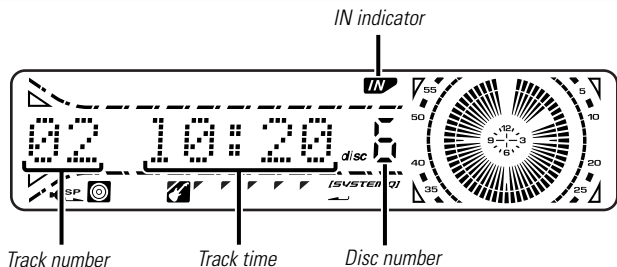

KDC-5020/5020R

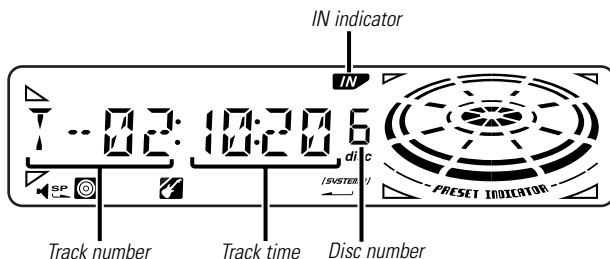

Playing CD & MP3

When there is no disc inserted

- 1 Drop open the faceplate
Press the Release button.
- 2 Insert a disc.
- 3 Press the faceplate on the right side, and return it to its former position.

- ⚠ When the faceplate has been dropped open, it might interfere with the shift lever or something else. If this happens, pay attention to safety and move the shift lever or take an appropriate action, then operate the unit.
- Do not use the unit with the faceplate in the open condition. If it's used in the open position dust can enter the inside part and cause damage.

- 💬 The models that can play MP3 is shown below.
KDC-MPV7020
- When a disc is inserted, the "IN" indicator is ON.

When a disc is inserted

- 1 Press the [SRC] button.
Select the "CD" display.

Pause and play

- 1 Press the [▶II] button.
Each time the button is pressed it pauses and plays.

Eject the disc

- 1 Drop open the faceplate
Press the Release button.
- 2 Eject the disc
Press the [▲] button.

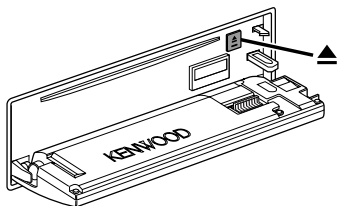

3 Press the faceplate on the right side, and return it to its former position.

 3 in. (8cm) disc can't be played. Using an adapter and inserting them into this unit can cause damage.

 The MP3 media that this unit can play are CD-ROM, CD-R, and CD-RW.

The medium formats must be ISO 9660 Level 1, Level 2, Joliet, or Romeo. The methods and precautions to be followed for writing MP3 data are covered in <Notes on playing MP3> (page 6). Check that section before creating your MP3 media.

Playing External Disc

Playing discs set in the optional accessory disc player connected to this unit.

Press the [SRC] button.

Select the display for the disc player you want.

Display examples:

Display	Disc player
"CD2"	CD player
"DISC-CH"	CD changer/ MD changer

Pause and play

Press the [▶||] button.

Each time the button is pressed it pauses and plays.



- Disc #10 is displayed as "0".
- The functions that can be used and the information that can be displayed will differ depending on the external disc players being connected.

Fast Forwarding and Reversing

Fast Forwarding

Hold down on the [▶▶] button.

Release your finger to play the disc at that point.

Reversing

Hold down on the [◀◀] button.

Release your finger to play the disc at that point.

Track Search

Selecting the song you want to hear.

Searching for a song on the disc or in the MP3 folder.

Press the [◀◀] or [▶▶] button.

Album Search

Selecting the disc set in the Disc changer or the folder recorded on the MP3 media.

Press the [FM] or [AM] button.

CD/MP3/External disc control features

Direct Track Search (Function of remote)

Doing Track Search by entering the track number.

1 Enter the track number

Press the number buttons on the remote.

2 Do Track Search

Press the [◀◀] or [▶▶] button.

Canceling Direct Track Search

Press the [▶||] button.

Direct Album Search (Function of disc changers with remote)

Doing Disc Search by entering the disc number.

1 Enter the disc number

Press the number buttons on the remote.

2 Do Album Search

Press the [DISC+] or [DISC-] button.

Canceling Direct Album Search

Press the [▶||] button.



Input "0" to select disc 10.

Track/Album Repeat

Replaying the song, disc in the Disc changer or MP3 folder you're listening to.

Press the [REP] button.

Each time the button is pressed the Repeat Play switches as shown below.

Repeat play

Track Repeat (In CD/MD)
(In MP3)

Display

"REP ON"/"T-REP ON"
"REP ON"

Album Repeat (In Disc Changer)
(In MP3 media)

"D-REP ON"
"F REP ON"

OFF

"REP OFF"

Track Scan

Playing the first part of each song on the disc or MP3 folder you are listening to and searching for the song you want to listen to.

1 Start Track Scan

Press the [SCAN] button.

"Scan ON"/ "SCAN ON"/ "SCN ON" is displayed.

2 Release it when the song you want to listen to is played

Press the [SCAN] button.

Random Play

Play all the songs on the disc or MP3 folder in random order.

Press the [RDM] button.

Each time the button is pressed Random Play turns ON or OFF. When it's ON, "RDM ON" is displayed.



When the [▶▶] button is pressed, the next song select starts.

Magazine Random Play (Function of disc changer)

Play the songs on all the discs in the disc changer in random order.

Press the [M.RDM] button.

Each time the button is pressed the Magazine Random Play turns ON or OFF.

When it's ON, "MRDM ON" is displayed.

 When the [▶▶] button is pressed, the next song select starts.

Function of the KDC-MPV7020/KDC-6020

Album Select (Function of MP3)

Quickly selecting the folder you want to listen to.

1 Enter Album Select mode

Press the [#5] button.

"SELECT MODE" is displayed.

During Select mode the folder information is displayed as shown below.

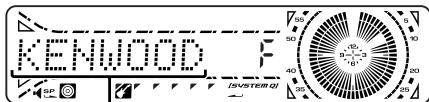

<Folder name display>

Displays the current folder name.

2 Select the folder level

Press the [FM] or [AM] button.

With the [FM] button you move 1 level down and with the [AM] button 1 level up.

Selecting a folder in the same level

Press the [◀◀] or [▶▶] button.

With the [◀◀] button you move to the previous folder, and with the [▶▶] button to the next folder.

Returning to the top level

Press the [#3] button.

3 Decide the folder to play

Press the [▶||] button.

The Album Select mode releases, and the MP3 in the folder being displayed is played.

 The methods for moving to other folders in the album select mode are different from those in the album search mode. See <Notes on playing MP3> (page 6) for details.

Canceling the Album Select mode

Press the [#5] button.

Text/Title Scroll

Scrolling the displayed CD text, MP3 text, or MD title.

Press the [DISP] button for at least 1 second.

DNPP (Disc Name Preset Play) (Function of disc changers with remote)

Selecting the CD displayed in the DNPS of the CDs set in the Disc changer.

1 Enter DNPP mode

Press the [DNPP] button on the remote.

When "DNPP" is displayed the DNPS display in order.

Forward / Reverse display

Press the [DISC-] or [DISC+] button.

2 When the disc you want is displayed

Press the [OK] button on the remote.

The disc being displayed is played.

Canceling the DNPP mode

Press the [DNPP] button on the remote.

Menu system

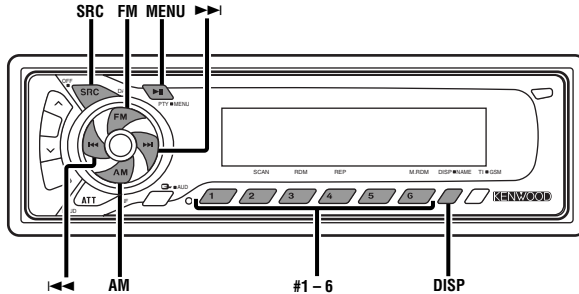

KDC-MPV7020/6020

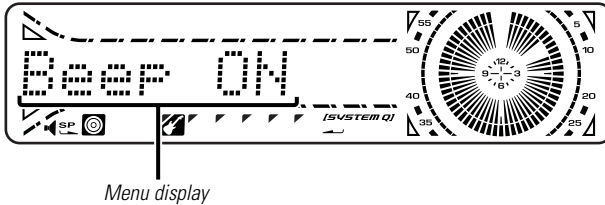

KDC-5020/5020R

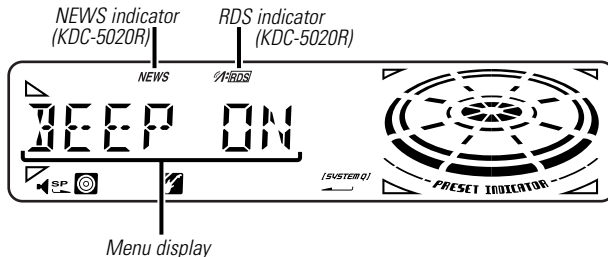

Menu System

Setting during operation beep sound etc. functions. The Menu system basic operation method is explained here. The reference for the Menu items and their setting content is after this operation explanation.

1 Enter Menu mode

Press the [MENU] button for at least 1 second.
"MENU" is displayed.

2 Select the menu item

Press the [FM] or [AM] button.
Example: When you want to set the beep sound select the "Beep"/ "BEEP" display.

3 Set the menu item

Press the [◀] or [▶] button.
Example: When "Beep"/ "BEEP" is selected, each time the button is pressed it switches "Beep ON"/ "BEEP ON" or "Beep OFF"/ "BEEP OFF". Select 1 of them as the setting.
You can continue by returning to step 2 and setting other items.

4 Exit Menu mode

Press the [MENU] button.



When other items that are applicable to the basic operation method above are displayed afterwards their setting content chart is entered. (Normally the uppermost setting in the chart is the original setting.)

Also, the explanation for items that aren't applicable (<Manual Clock Adjustment>etc.) are entered step by step.

Security Code

Because authorization by the Security Code is required when it's removed from the vehicle, personalizing this unit is by using the Security Code is a help in preventing theft.



When the Security Code function is activated it can't be released.
Note, your Security Code is the 4 digit number entered in your "Car Audio Passport" in this package.

1 Enter Standby

Press the [SRC] button.

Select the "ALL OFF" display.

2 Enter Menu mode

Press the [MENU] button for at least 1 second.

When "MENU" is displayed, "Security"/ "SECURITY" is displayed.

3 Enter Security Code mode

Press the [◀◀] or [▶▶] button for at least 1 second.

When "ENTER" is displayed, "CODE" is displayed.

4 Select the digits to enter

Press the [◀◀] or [▶▶] button.

5 Select the Security Code numbers

Press the [FM] or [AM] button.

6 Repeat steps 4 and 5, and complete the Security Code.

7 Confirm the Security Code

Press the [▶▶] button for at least 3 seconds.

When "RE-ENTER" is displayed, "CODE" is displayed.

8 Do the step 4 through 7 step operation, and reenter the security code.

"APPROVED" is displayed.

The Security Code function activates.



If you enter a Code different from your Security Code, you have to start over from step 4.

Press the Reset button and when it's removed from the battery power source

1 Turn the power ON.

2 Do the step 4 through 7 step operation, and reenter the security code.

"APPROVED" is displayed.

The unit can be used.



If an incorrect code is input, "WAITING" is displayed, and the input prohibited time shown below is generated.

After the input prohibited time lapses, "CODE" is displayed, and input can be done.

Number of times the incorrect code was input	Input prohibited time
---	-----------------------

1	—
2	5 minutes
3	1 hour
4	24 hours

Touch Sensor Tone

Setting the operation check sound (beep sound) ON/OFF.

Display	Setting
"Beep ON"/ "BEEP ON"	Beep is heard.
"Beep OFF"/ "BEEP OFF"	Beep canceled.

Menu system

Manual Clock Adjustment



This adjustment can be done when the <Synchronize Clock> (page 26) is set as OFF.

1 Select Clock Adjustment mode

Press the [FM] or [AM] button.
Select the "CLK ADJ" display.

2 Enter Clock Adjust mode

Press the [◀◀] or [▶▶] button for at least 1 second.
The clock display blinks.

3 Adjust the hours

Press the [FM] or [AM] button.

Adjust the minutes

Press the [◀◀] or [▶▶] button.

4 Exit Clock adjustment mode

Press the [MENU] button.

Function of the KDC-5020R

Synchronize Clock

Synchronizing the RDS station time data and this unit's clock.

Display	Setting
"SYNC ON"	Synchronizes the time.
"SYNC OFF"	Adjust the time manually.



It takes 3 to 4 minutes to synchronize the clock.

DSI (Disabled System Indicator)

A red indicator will blink on the unit after the faceplate is

removed, warning potential thieves.

Display	Setting
"DSI ON"	LED flashes.
"DSI OFF"	LED OFF.

Function of the KDC-MPV7020/KDC-6020/KDC-5020R

Selectable Illumination

Selecting the button illumination color as green or red.

Display	Setting
"KEY GRN"	The illumination color is green.
"KEY RED"	The illumination color is red.

Function of the KDC-5020/KDC-5020R

Switching Graphic Display

Setting the graphic part display ON/OFF.

Display	Setting
"GRPH ON"	The graphic part is displayed.
"GRPH OFF"	The graphic part isn't displayed.

Function of the KDC-MPV7020/KDC-6020

Switching Display Type

Setting the Display type.

Display	Setting
"DisplayD"	Demonstration.
"DisplayA"	Circle Display is play time.

"DisplayB"	Circle Display is clock.
"DisplayC"	Silent display type.

Function of the KDC-MPV7020

Illumination Color Setting

You can set the display to a desired color.

1 Select Illumination Color Setting Mode

Press the [FM] or [AM] button.
Select the "COL" display.

2 The color continues to change gradually

Continue pressing the [◀◀] or [▶▶] button.
Release your finger at the color you want.

Quick call up the preset color

Press the [#1] – [#4] button.

Button	Color
[#1]	Silky White
[#2]	Red
[#3]	Blue
[#4]	Blue Green

Selecting the Color mode

Press the [#6] button.
Each time the button is pressed the Color mode switches as shown below.

Display	Color mode
"Scan"	The color changes in sequence.
"SRC"	The color changes according to the selected source.
"Time"	The color changes every 6 hours.
	Keeps the presently set color.

Blue fine adjustment

- 1 Press the [#3] button for at least 2 seconds.
- 2 Press the [◀◀] or [▶▶] button.
When the blue fine adjustment is completed, press the [#3] button.

The set color memory

Press the [#5] button for at least 2 seconds.
When the setting in the memory is called up press the [#5] button.



The blue fine adjustment setting cannot be stored in memory.

Function of the KDC-MPV7020/KDC-6020

Contrast Adjustment

Adjusting the display contrast.

Display and Setting

"CONT 0"	
:	
"CONT 5" (Original setting)	
:	
"CONT 10"	

Function of the KDC-MPV7020/KDC-6020

Dimmer

Dimming this unit's display automatically when the vehicle light switch is turned ON.

Display	Setting
"DIM ON"	The display dims.
"DIM OFF"	The display doesn't dim.

Menu system

Function of the KDC-MPV7020/KDC-6020

Switching preout

Switching the preout between the rear and non-fading. (In non-fading it outputs without effect from the fader control.)

Display	Setting
"SWPRE R"	Rear preout.
"SWPRE NF"	Non-fading preout.

Function of the KDC-5020R

News Bulletin with Timeout Setting

It switches automatically when a news bulletin starts even if the radio isn't being listened to. Also, the time interval when interrupt is prohibited can be set.

Display and Setting

"NEWS OFF"
"NEWS 00M"
:
"NEWS 90M"

When "NEWS 00M" — "NEWS 90M" is set, the News Bulletin Interrupt function is ON.

When it's ON, the "NEWS" indicator is ON.

When the news bulletin starts, "NEWS" is displayed, and it switches to the news bulletin.



- If you choose the "20M" setting, further news bulletins will not be received for 20 minutes once the first news bulletin is received.
- The news bulletin volume is the same level that was set for traffic information (page 15).
- This function is only available if the desired station sends PTY-code for news bulletin or belongs to <Enhanced Other Network>-Network sending PTY-code for news bulletin.
- When the News Bulletin Interrupt function is ON, it switches to an FM station.

Function of the KDC-5020R

Local Seek <In Tuner mode>

Only stations whose reception is good are searched for in auto seek tuning.

Display	Setting
"LO.S OFF"	The local seek function is OFF.
"LO.S ON"	The local seek function is ON.

Function of the KDC-5020R

Tuning Mode <In Tuner mode>

Sets the tuning mode.

Tuning mode	Display	Operation
Auto seek	"AUTO 1"	Automatic search for a station.
Preset station seek	"AUTO 2"	Search in order of the stations in the Preset memory.
Manual	"MANUAL"	Normal manual tuning control.

Function of the KDC-MPV7020/KDC-6020/KDC-5020R

Auto Memory Entry <In Tuner mode>

For the operation method refer to <Auto Memory Entry> (page 14/ 19).

Function of the KDC-MPV7020/KDC-6020/KDC-5020

CRSC (Clean Reception System Circuit) <In FM reception>

Temporarily have reception switched from stereo to mono to reduce multi-path noise when listening to the FM station.

Display

"CRSC ON"

"CRSC OFF"

Setting

The CRSC is ON.

The CRSC is OFF.



Strong electrical fields (such as from power lines) may cause unstable sound quality when CRSC is turned ON. In such a situation, turn it OFF.

*Function of the KDC-5020R***AF (Alternative Frequency)**

When poor reception is experienced, automatically switch to another frequency broadcasting the same program in the same RDS network with better reception.

Display

"AF ON"

"AF OFF"

Setting

The AF function is ON.

The AF function is OFF.

When the AF function is ON, the "RDS" indicator is ON.



When no other stations with stronger reception are available for the same program in the RDS network, you may hear the incoming broadcast in bits and snatches. Turn OFF the AF function in such a case.

*Function of the KDC-5020R***Restricting RDS Region****(Region Restrict Function)**

You can choose whether or not to restrict the RDS channels, received with the AF function for a particular network, to a specific region.

Display

"REG ON"

"REG OFF"

Setting

The Region Restrict Function is ON.

The Region Restrict Function is OFF.



Sometimes stations in the same network broadcast different programs or use different program service names.

*Function of the KDC-5020R***Auto TP Seek**

When the TI function is ON and poor reception conditions are experienced when listening to a traffic information station, another traffic information station with better reception will be searched for automatically.

Display

"ATPS ON"

"ATPS OFF"

Setting

The Auto TP Seek Function is ON.

The Auto TP Seek Function is OFF.

*Function of the KDC-5020R***Monaural Reception <In FM reception>**

Noise can be reduced when stereo broadcasts are received as monaural.

Display

"MONO OFF"

"MONO ON"

Setting

The monaural reception is OFF.

The monaural reception is ON.

Menu system

Function of the KDC-MPV7020/KDC-6020/KDC-5020

Text Scroll

Setting the displayed text scroll.

Display	Setting
"SCL AUTO"	Repeats scroll.
"SCL MANU"	Scrolls when the display changes.



The text scrolled is shown below.

- CD text
- Folder name/ File name/ Song title/ Artist name/ Album name
- MD title

Function of the KDC-5020R

Text Scroll

Setting the displayed text scroll.

Display	Setting
"SCL MANU"	Doesn't scroll.
"SCL AUTO"	Scrolls when the display changes.



The text scrolled is shown below.

- CD text
- MD title
- Radio text

Function of the KDC-MPV7020/KDC-6020

Built-in Auxiliary input Setting

Set the Built-in Auxiliary Input function.

Display	Setting
"AUX OFF"	When selecting the source there's no Auxiliary Input.
"AUX ON"	When selecting the source there's Auxiliary Input.

Basic Operations of remote

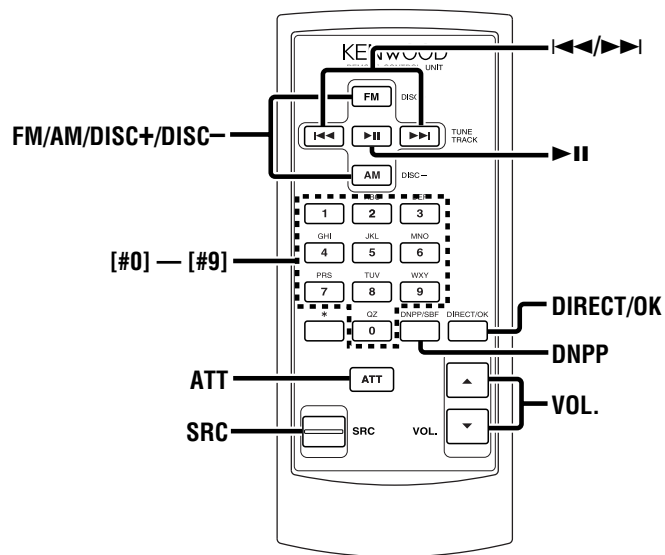

Loading and Replacing the battery

Use one lithium battery (CR2025).
Insert the batteries with the + and – poles aligned properly,
following the illustration inside the case.

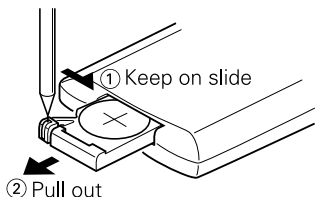

▲WARNING

Store unused batteries out of the reach of children. Contact a doctor
immediately if the battery is accidentally swallowed.

⚠ Do not set the remote on hot places such as above the dashboard.

Basic operations

[VOL.] buttons

Adjusting the volume.

[SRC] button

Each time the button is pressed the source switches.
For the source switching order refer to <Selecting the Source>
(page 8).

[ATT] button

Turning the volume down quickly.
When it is pressed again it returns to the previous level.

In Tuner source

[FM]/ [AM] buttons

Select the band.

Each time the [FM] button is pressed it switches between the
FM1, FM2, and FM3 bands.

[◀◀]/ [▶▶] buttons

Tune up or down band.

[#0] – [#9] buttons

Press buttons [#1] — [#6] to recall preset stations.

[DIRECT] button

Enters and cancels the <Direct Access Tuning> (page 13/ 18)
mode.

[▶ II] button (KDC-5020R only)

Enters and cancels the <PTY (Program Type)> (page 16) mode.

In Disc source

[◀◀]/ [▶▶] buttons

Doing track forward and backward.

[DISC+]/ [DISC-] buttons

Doing album forward and backward.

[▶ II] button

Each time the button is pressed the song pauses and plays.

[DNPP]/ [OK] button

Enters and cancels the <DNPP (Disc Name Preset Play)> (page
23) mode.

[#0] – [#9] buttons

When in <Direct Track Search> (page 22) and <Direct Album
Search> (page 22), enter the track/disc number.

Accessories (KDC-MPV7020/6020/5020)

External view

..... Number of items

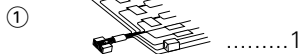

External view

..... Number of items

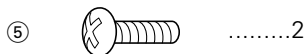

The use of any accessories except for those provided might result in damage to the unit. Make sure only to use the accessories shipped with the unit, as shown above.

Installation Procedure (KDC-MPV7020/6020/5020)

1. To prevent a short circuit, remove the key from the ignition and disconnect the \ominus battery.
2. Make the proper input and output wire connections for each unit.
3. Connect the speaker wires of the wiring harness.
4. Connect the wiring harness wires in the following order: ground, battery, ignition.
5. Connect the wiring harness connector to the unit.
6. Install the unit in your car.
7. Reconnect the \ominus battery.
8. Press the reset button.

▲WARNING

If you connect the ignition wire (red) and the battery wire (yellow) to the car chassis (ground), you may cause a short circuit, that in turn may start a fire. Always connect those wires to the power source running through the fuse box.

▲CAUTION

- If your car's ignition does not have an ACC position, connect the ignition wires to a power source that can be turned on and off with the ignition key. If you connect the ignition wire to a power source with a constant voltage supply, as with battery wires, the battery may die.
- If the console has a lid, make sure to install the unit so that the faceplate will not hit the lid when closing and opening.
- If the fuse blows, first make sure the wires aren't touching to cause a short circuit, then replace the old fuse with one with the same rating.
- Insulate unconnected wires with vinyl tape or other similar material. To prevent a short circuit, do not remove the caps on the ends of the unconnected wires or the terminals.
- Connect the speaker wires correctly to the terminals to which they correspond. The unit may be damaged or fail to work if you share the \ominus wires or ground them to any metal part in the car.
- When only two speakers are being connected to the system, connect the connectors either to both the front output terminals or to both the rear output terminals (do not mix front and rear). For example, if you connect the \oplus connector of the left speaker to a front output terminal, do not connect the \ominus connector to a rear output terminal
- After the unit is installed, check whether the brake lamps, blinkers, wipers, etc. on the car are working properly.
- Mount the unit so that the mounting angle is 30° or less.

Connecting Wires to Terminals (KDC-MPV7020/6020/5020)

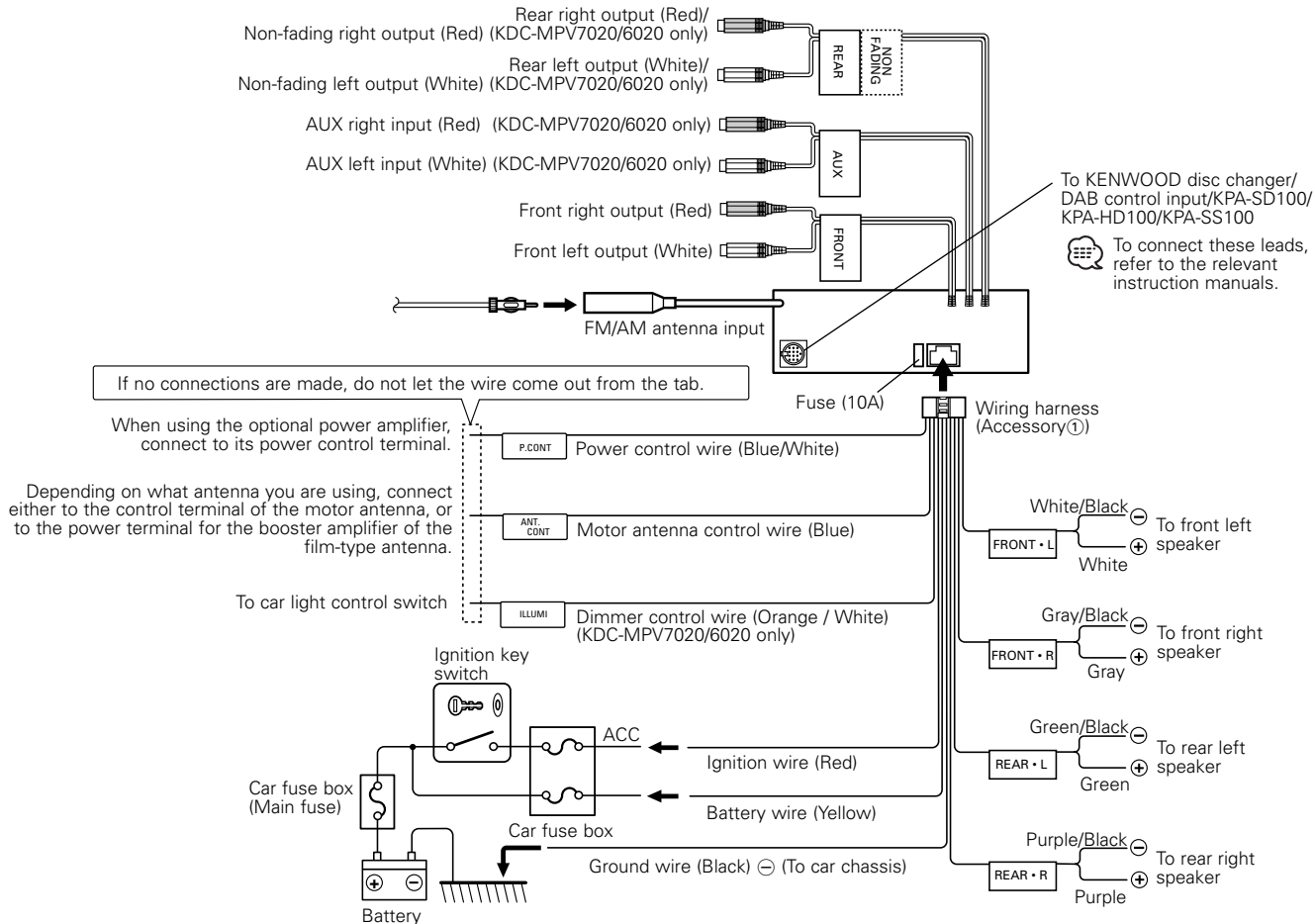

Accessories (KDC-5020R)

External view

..... Number of items

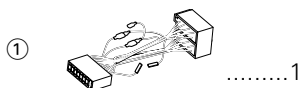

External view

..... Number of items

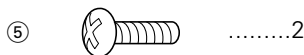

The use of any accessories except for those provided might result in damage to the unit. Make sure only to use the accessories shipped with the unit, as shown above.

Installation Procedure (KDC-5020R)

1. To prevent a short circuit, remove the key from the ignition and disconnect the \ominus battery.
2. Make the proper input and output wire connections for each unit.
3. Connect the wire on the wiring harness.
4. Take Connector B on the wiring harness and connect it to the speaker connector in your vehicle.
5. Take Connector A on the wiring harness and connect it to the external power connector on your vehicle.
6. Connect the wiring harness connector to the unit.
7. Install the unit in your car.
8. Reconnect the \ominus battery.
9. Press the reset button.

▲WARNING

If you connect the ignition wire (red) and the battery wire (yellow) to the car chassis (ground), you may cause a short circuit, that in turn may start a fire. Always connect those wires to the power source running through the fuse box.

▲CAUTION

- If your car's ignition does not have an ACC position, connect the ignition wires to a power source that can be turned on and off with the ignition key. If you connect the ignition wire to a power source with a constant voltage supply, as with battery wires, the battery may die.
- If the console has a lid, make sure to install the unit so that the faceplate will not hit the lid when closing and opening.
- If the fuse blows, first make sure the wires aren't touching to cause a short circuit, then replace the old fuse with one with the same rating.
- Insulate unconnected wires with vinyl tape or other similar material. To prevent a short circuit, do not remove the caps on the ends of the unconnected wires or the terminals.
- Connect the speaker wires correctly to the terminals to which they correspond. The unit may be damaged or fail to work if you share the \ominus wires or ground them to any metal part in the car.
- When only two speakers are being connected to the system, connect the connectors either to both the front output terminals or to both the rear output terminals (do not mix front and rear). For example, if you connect the \oplus connector of the left speaker to a front output terminal, do not connect the \ominus connector to a rear output terminal
- After the unit is installed, check whether the brake lamps, blinkers, wipers, etc. on the car are working properly.
- Mount the unit so that the mounting angle is 30° or less.

Connecting Wires to Terminals (KDC-5020R)

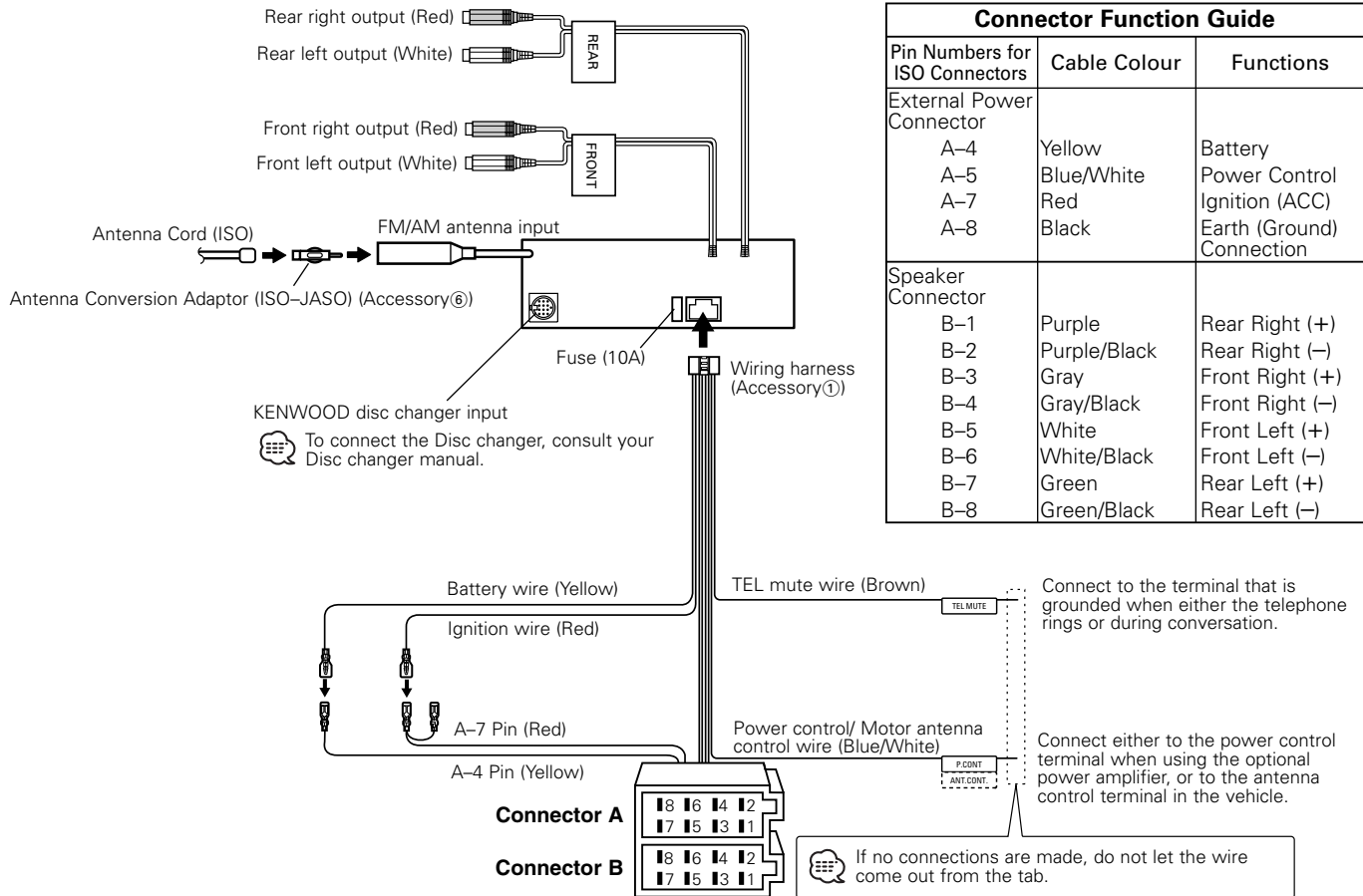

Connecting Wires to Terminals (KDC-5020R)

⚠ WARNING Connecting the ISO Connector (see p.23)

The pin arrangement for the ISO connectors depends on the type of vehicle you drive. Make sure to make the proper connections to prevent damage to the unit.

The default connection for the wiring harness is described in [1](#) below. If the ISO connector pins are set as described in [2](#) or [3](#), make the connection as illustrated.



When the connection is made as in [3](#) above, the unit's power will not be linked to the ignition key. For that reason, always make sure to turn off the unit's power when the ignition is turned off.

To link the unit's power to the ignition, connect the ignition cable (ACC...red) to a power source that can be turned on and off with the ignition key.

- [1](#) (Default setting) The A-7 pin (red) of the vehicle's ISO connector is linked with the ignition, and the A-4 pin (yellow) is connected to the constant power supply.

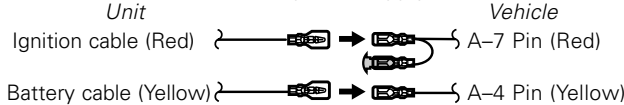

- [2](#) The A-7 pin (red) of the vehicle's ISO connector is connected to the constant power supply, and the A-4 pin (yellow) is linked to the ignition.

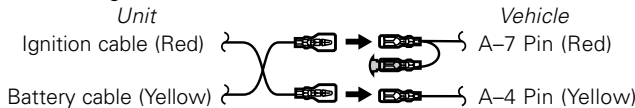

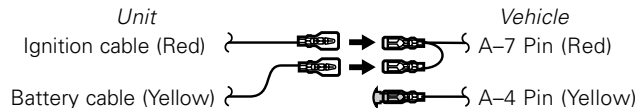

- [3](#) The A-4 pin (yellow) of the vehicle's ISO connector is not connected to anything, while the A-7 pin (red) is connected to the constant power supply (or both the A-7 (red) and A-4 (yellow) pins are connected to the constant power supply).

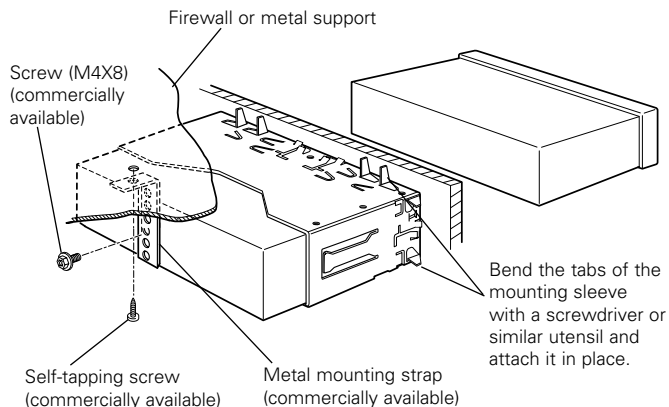

Installation

■ Installation



 Make sure that the unit is installed securely in place. If the unit is unstable, it may malfunction (for example, the sound may skip).

■ Installing in Japanese-Made Cars

- 1 Refer to the section "Removing the hard rubber frame" (page 38) and then remove the hard rubber frame.
- 2 Align the holes in the unit (two locations on each side) with the vehicle mounting bracket and secure the unit with the accessory screws.

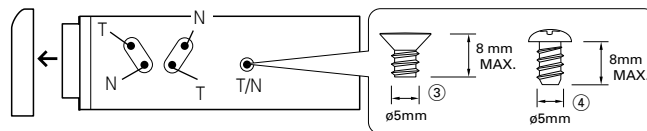

-  During installation, do not use any screws except for those provided. The use of different screws might result in damage to the main unit.
- Damage may occur if a screwdriver or similar tool is used with excessive force during the installations.

■ Screwing the Faceplate on the Unit

If you want to fasten the faceplate to the main unit so that it does not fall off, screw in the provided screws ($\phi 4 \times 16$ mm) in the holes shown below.

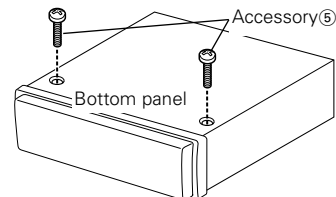

-  Never insert the tapite screw ($\phi 4 \times 16$ mm) in any other screw hole than the one specified. If you screw it in another hole, it will contact and may cause damage to the mechanical parts inside the unit.

Installation

■ Removing the hard rubber frame

- 1 Engage the catch pins on the removal tool and remove the two locks on the lower level.
Lower the frame and pull it forward as shown in the figure.

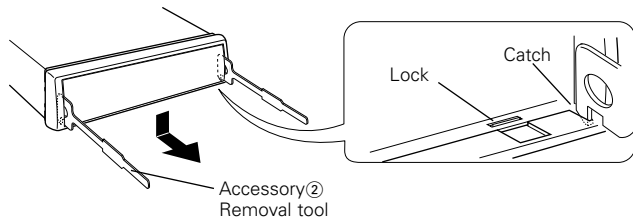

- 2 When the lower level is removed, remove the upper two locations.

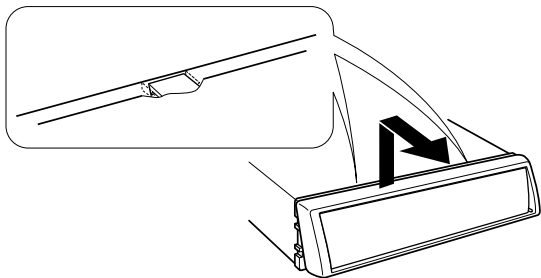

The frame can be removed from the top side in the same manner.

■ Removing the Unit

- 1 Refer to the section “Removing the hard rubber frame” and then remove the hard rubber frame.
- 2 Remove the screw (M4 × 8) on the back panel.
- 3 Insert the two removal tools deeply into the slots on each side, as shown.

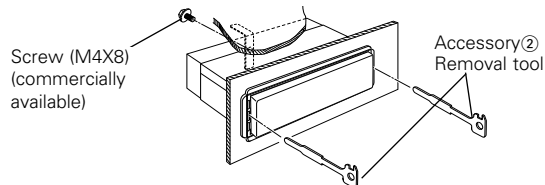

- 4 Lower the removal tool toward the bottom, and pull out the unit halfway while pressing towards the inside.



Be careful to avoid injury from the catch pins on the removal tool.

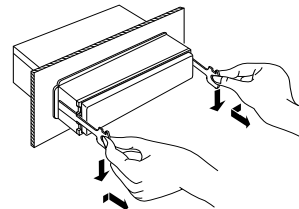

- 5 Pull the unit all the way out with your hands, being careful not to drop it.

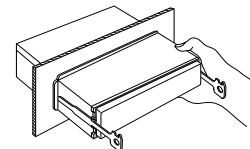

Troubleshooting Guide

What might seem to be a malfunction in your unit may just be the result of slight misoperation or miswiring. Before calling service, first check the following table for possible problems.

General

? The power does not turn ON.

- ✓ The fuse has blown.
 - ☞ After checking for short circuits in the wires, replace the fuse with one with the same rating.
- ✓ No ACC position on vehicle ignition.
 - ☞ Connect the same wire to the ignition as the battery wire.

? Nothing happens when the buttons are pressed.

- ✓ The computer chip in the unit is not functioning normally.
 - ☞ Press the reset button on the unit (page 4).

? There's a source you can't switch.

- ✓ There's no CD inserted.
 - ☞ Set the media you want to listen to. If there's no media in this unit, you can't switch to each source.
- ✓ The Disc changer isn't connected.
 - ☞ Connect the Disc changer. If the Disc changer isn't connected to its input terminal, You can't switch to an external disc source.

? The memory is erased when the ignition is turned OFF.

- ✓ The battery wire has not been connected to the proper terminal.
 - ☞ Connect the wire correctly, referring to the section on <Connecting Wires to Terminals>.
- ✓ The ignition and battery wire are incorrectly connected.
 - ☞ Connect the wire correctly, referring to the section on <Connecting Wires to Terminals>.

? There's no loudness effect.

- ✓ You're using Non-fading preout.
 - ☞ Loudness has no effect in Non-fading preout.

? The Non-fading output can't be turned ON or OFF.

- ✓ The <Switching Preout> (page 28) is set is set on Rear preout.
 - ☞ Change it to Non-fading preout.

? The TEL mute function does not work.

- ✓ The TEL mute wire is not connected properly.
 - ☞ Connect the wire correctly, referring to the section on <Connecting Wires to Terminals>.

? The TEL mute function turns ON even though the TEL mute wire is not connected.

- ✓ The TEL mute wire is touching a metal part of the car.
 - ☞ Pull the TEL mute wire away from the metal part of the car.

? Even if Loudness is turned ON, high-pitched tone isn't compensated for.

- ✓ Tuner source is selected.
 - ☞ High-pitched tone isn't compensated for when in Tuner source.

? No sound can be heard, or the volume is low.

- ✓ The fader or balance settings are set all the way to one side.
 - ☞ Center the fader and balance settings.
- ✓ The input/output wires or wiring harness are connected incorrectly.
 - ☞ Reconnect the input/output wires or the wiring harness correctly. See the section on <Connecting Wires to Terminals>.
- ✓ The values of Volume offset are low.
 - ☞ Increase the values of Volume offset. (page 9)

? The sound quality is poor or distorted.

- ✓ One of the speaker wires is being pinched by a screw in the car.
 - ☞ Check the speaker wiring.
- ✓ The speakers are not wired correctly.
 - ☞ Reconnect the speaker wires so that each output terminal is connected to a different speaker.

? The Security Code item isn't displayed in the Menu System.

- ✓ The Security Code function is already activated.
 - ☞ When the Security Code function is activated it isn't displayed in the menu items.

? The Touch Sensor Tone doesn't sound.

- ✓ The preout jack is being used.
 - ☞ The Touch Sensor Tone can't be output from the preout jack.

Troubleshooting Guide

? Even though Synchronize Clock is ON, the clock can't be adjusted.

- ✓ The received RDS station isn't sending time data.
 - ☞ Receive another RDS station.

? The Dimmer function doesn't work.

- ✓ The Dimmer wire isn't connected correctly.
 - ☞ Check the Dimmer wire connection.

? The display color changes subtly.

- ✓ This is because the temperature is different than the temperature when the setting was done.
 - ☞ The display color condition changes subtly according to the ambient temperature.

Tuner source

? Radio reception is poor.

- ✓ The car antenna is not extended.
 - ☞ Pull the antenna out all the way.
- ✓ The antenna control wire is not connected.
 - ☞ Connect the wire correctly, referring to the section on <Connecting Wires to Terminals>.

? The desired frequency can't be entered with the Direct Access Tuning.

- ✓ A station that can't be received is being entered.
 - ☞ Enter a station that can be received.
- ✓ You're trying to enter a frequency with a 0.01 MHz unit.
 - ☞ What can be designated in the FM band is to 0.1 MHz.

? It isn't the set Traffic information sound volume.

- ✓ The set sound volume is less than the tuner sound volume.
 - ☞ If the tuner sound volume is louder than the set sound volume, the tuner sound volume is used.

Disc source

? "AUX" is displayed without achieving External disc control mode.

- ✓ O-N switch is set to "O" side.
 - ☞ Set the switch to "N" side.
- ✓ Unsupported disc changer is connected.
 - ☞ Connect the supported disc changer. (page 3)

? The specified disc does not play, but another one plays instead.

- ✓ The specified CD is quite dirty.
 - ☞ Clean the CD.
- ✓ The CD is upside-down.
 - ☞ Load the CD with the labeled side up.
- ✓ The disc is loaded in a different slot from that specified.
 - ☞ Eject the disc magazine and check the number for the specified disc.
- ✓ The disc is severely scratched.
 - ☞ Try another disc instead.

? The specified track will not play.

- ✓ Random play or magazine random play has been selected.
 - ☞ Turn off random play or magazine random play.

? Track repeat, disc repeat, track scan, random play, and magazine random play start by themselves.

- ✓ The setting is not canceled.
 - ☞ The settings for these functions remain on until the setting to off or the disc ejected, even if the power is turned off or the source changed.

? Cannot play CD-R or CD-RW.

- ✓ Finalization processing is not being conducted for CD-R/CD-RW.
 - ☞ Conduct finalization processing with CD recorder.
- ✓ A non-compatible CD changer is being used to play the CD-R/CD-RW.
 - ☞ Use a CD changer compatible with CD-R/CD-RW to play.

? A CD ejects as soon as it is loaded.

- ✓ The CD is upside-down.
 - ☞ Load the CD with the labeled side up.
- ✓ The CD is quite dirty.
 - ☞ Clean the CD, referring to the section on <CD cleaning> (page 5).

? Can't remove disc.

- ✓ The cause is that more than 10 minutes has elapsed since the vehicle ACC switch was turned OFF.
 - ☞ The disc can only be removed within 10 minutes of the ACC switch being turned OFF. If more than 10 minutes has elapsed, turn the ACC switch ON again and press the Eject button.

? **The disc won't insert.**

- ✓ There's already another disc inserted.
 - ☞ Press the [▲] button and remove the disc.

? **Direct Track Search and Direct Album Search can't be done.**

- ✓ Another function is ON.
 - ☞ Turn Random Play or other functions OFF.

? **Track Search can't be done.**

- ✓ For the albums first or last song.
 - ☞ For each album, Track Search can't be done in the backward direction for the first song or in the forward direction for the last song.

MP3 source

? **Cannot play an MP3.**

- ✓ Not conforming to ISO 9660 Level 1/2, Joliet, and Romeo.
 - ☞ Use a medium conforming to ISO 9660 Level 1/2, Joliet, and Romeo.
- ✓ The MP3 has no or invalid track name extension.
 - ☞ Add the ".MP3" extension to the MP3 track name.
- ✓ The media is scratched or dirty.
 - ☞ Clean the media, referring to the section on <CD cleaning> (page 5).

? **Noise or no sound generated when an MP3 is played.**

- ✓ The track has the MP3 track name extension while it is not an MP3.
 - ☞ Do not use the ".MP3" extension in non-MP3.

? **Takes time before the unit starts playing MP3.**

- ✓ The medium contains many albums, tracks, and hierarchical levels.
 - ☞ The unit checks all tracks on the loaded medium first. If the medium has many tracks recorded, it may take a long time for the unit before it starts playing MP3.

? **Fails to play MP3 in the intended order.**

- ✓ The MP3 tracks were not written by the CD writer in the order in which you wanted them to be played.
 - ☞ Depending on the CD writer, you may be able to set the order in which MP3 tracks are to be played by writing them onto a medium with their track names beginning with play sequence numbers such as "01" to "99".

? **The sound skips when an MP3 is being played.**

- ✓ The media is scratched or dirty.
 - ☞ Clean the media, referring to the section on <CD cleaning> (page 5).
- ✓ The recording condition is bad.
 - ☞ Record the media again or use another media.

? **Can't display the ID3 tag information correctly.**

- ✓ Record is not made in conformity with the ID 3 tag version1.x.
 - ☞ Record in conformity with the ID 3 tag version1.x.

? **Can't enter Album Select mode.**

- ✓ There's no folder recorded in the MP3 media.
 - ☞ Use a media with levels.

? **The songs in the selected folder aren't played in Album Select mode.**

- ✓ There are no MP3 in the selected folder.
 - ☞ Make sure there's recorded content in the MP3 media.

? **The MP3 track/album search takes time.**

- ✓ Many tracks are recorded on the media.
 - ☞ When the media directory is complex, the track/album search can take time.

? **The MP3 related text isn't displayed correctly.**

- ✓ A character is entered that this unit can't display.
 - ☞ For the characters that can be used for MP3 text entry, refer to <Notes on playing MP3> (page 6).

? **The MP3 track time isn't displayed correctly.**

- ☞ There are times when it isn't displayed correctly according to the MP3 recording conditions.

If the following situations, consult your nearest service center:

- Even though the disc changer is connected, the Disc Changer source is not ON, with "AUX" showing in the display during the Changer Mode.
- Even though no device (KCA-S210A, CA-C1AX, KDC-CPS87, KDC-CX87, KDC-CPS85, KDC-CX85, KDC-CPS82 or KDC-CX82) is connected, the Auxiliary input is entered when switching modes.

Troubleshooting Guide

The messages shown below display your systems condition.

EJECT: No disc magazine has been loaded in the changer.
The disc magazine is not completely loaded.
⇨ Load the disc magazine properly.
No CD in the unit.
⇨ Insert the CD.

No Disc/NO DISC:
No disc has been loaded in the disc magazine.
⇨ Load a disc into the disc magazine.

TOC ER: No disc has been loaded in the disc magazine.
⇨ Load a disc into the disc magazine.
The CD is quite dirty. The CD is upside-down. The CD is scratched a lot.
⇨ Clean the CD and load it correctly.

E-05: The CD is upside-down.
⇨ Load the CD correctly.

BLANK: Nothing has been recorded on the MD.

NO TRACK: No tracks are recorded on the MD, although it has a title.

E-15: Media was played that doesn't have data recorded that the unit can play.
⇨ Use media that has data recorded that the unit can play.

NO PANEL: The faceplate of the slave unit being connected to this unit has been removed.
⇨ Replace it.

E-77: The unit is malfunctioning for some reason.
⇨ Press the reset button on the unit. If the "E-77" code does not disappear, consult your nearest service center.

MECHA ER: Something is wrong with the disc magazine. Or the unit is malfunctioning for some reason.
⇨ Check the disc magazine. And then press the reset button on the unit. If the "MECHA ER" code does not disappear, consult your nearest service center.

HOLD ER: The protective circuit in the unit activates when the temperature inside the automatic disc changer exceeds 60°C (140°F), stopping all operation.
⇨ Cool down the unit by opening the windows or turning on the air conditioner. As the temperature falls below 60°C (140°F), the disc will start playing again.

NO NAME: Attempted to display DNPS during the CD play having no disc names preset.

NO TITLE: Attempted to display the disc title or track title while the MD having no MD title is being played.

NO TEXT:

- Attempted to display the disc text or track text while the CD having no CD text is being played.
- Attempted to display text during reception of the station that isn't sending text data.
- Attempted to display the ID3 tag while the MP3 having no ID3 tag is being played.

WAITING: Radio text data is being received.

LOAD: Discs are being exchanged in the Disc changer.

NO ACCESS: After setting it in the Disc Changer, DNPP was done without having it been played at least 1 time.

IN (Blink): The CD player section is not operating properly.
⇨ Reinsert the CD. If the CD cannot be ejected or the display continues to flash even when the CD has been properly reinserted, please switch off the power and consult your nearest service center.

Specifications

Specifications subject to change without notice.

FM tuner section (KDC-MPV7020/6020/5020)

Frequency range (50 kHz space)	87.5 MHz – 108.0 MHz
(200 kHz space)	87.9 MHz – 107.9 MHz
Usable sensitivity (S/N = 30dB)	9.3dBf (0.8 μ V/75 Ω)
Quieting Sensitivity (S/N = 50dB)	15.2dBf (1.6 μ V/75 Ω)
Frequency response (\pm 3 dB)	30 Hz – 15 kHz
Signal to Noise ratio (MONO)	70 dB
Selectivity (\pm 400 kHz)	\geq 80 dB
Stereo separation (1 kHz)	40 dB

AM tuner section (KDC-MPV7020/6020/5020)

Frequency range (9 kHz space)	531 kHz – 1611 kHz
(10 kHz space)	530 kHz – 1700 kHz
Usable sensitivity (S/N = 20dB)	28 dB μ (25 μ V)

FM tuner section (KDC-5020R)

Frequency range (50 kHz space)	87.5 MHz – 108.0 MHz
Usable sensitivity (S/N = 26dB)	0.7 μ V/75 Ω
Quieting Sensitivity (S/N = 46dB)	1.6 μ V/75 Ω
Frequency response (\pm 3 dB)	30 Hz – 15 kHz
Signal to Noise ratio (MONO)	65 dB
Selectivity (DIN) (\pm 400 kHz)	\geq 80 dB
Stereo separation (1 kHz)	35 dB

MW tuner section (KDC-5020R)

Frequency range (9 kHz space)	531 kHz – 1611 kHz
Usable sensitivity (S/N = 20dB)	25 μ V

LW tuner section (KDC-5020R)

Frequency range	153 kHz – 281 kHz
Usable sensitivity (S/N = 20dB)	45 μ V

CD player section

Laser diode	GaAlAs (λ =780 nm)
Digital filter (D/A)	8 Times Over Sampling
D/A Converter	1 Bit
Spindle speed	
KDC-MPV7020	1000 – 400 (CLV 2times)
KDC-6020/5020/5020R	500 – 200 rpm (CLV)
Wow & Flutter	Below Measurable Limit
Frequency response (\pm 1 dB)	10 Hz – 20 kHz
Total harmonic distortion (1 kHz)	0.01 %
Signal to Noise ratio (1 kHz)	
KDC-MPV7020	105 dB
KDC-6020/5020/5020R	93 dB
Dynamic range	93 dB
Channel separation	85 dB
MP3 Decode (KDC-MPV7020)	
Compliant with MPEG-1.0/2.0/2.5 Audio Layer-3	

Audio section

Maximum output power	50 W x 4
Full Bandwidth Power (at less than 1% THD)	22 W x 4
Tone action	
Bass :	100 Hz \pm 10 dB
Middle :	1 kHz \pm 10 dB
Treble :	10 kHz \pm 10 dB
Preout level / Load (during disc play)	1800 mV/10 k Ω
Preout impedance	\leq 600 Ω

General

Operating voltage (11 – 16V allowable)	14.4 V
Current consumption	10 A
Installation Size (W x H x D)	182 x 53 x 155 mm
Weight	1.25 kg

KENWOOD