

USE AND CARE MANUAL

42 INCH AND 48 INCH BUILT-IN REFRIGERATORS

For Use With Models:

EF42DBSS, EF42NBSS, EF48DBSS, EF48NBSS
IF42DBOL, IF42NBOL, IF48DBOL, IF48NBOL

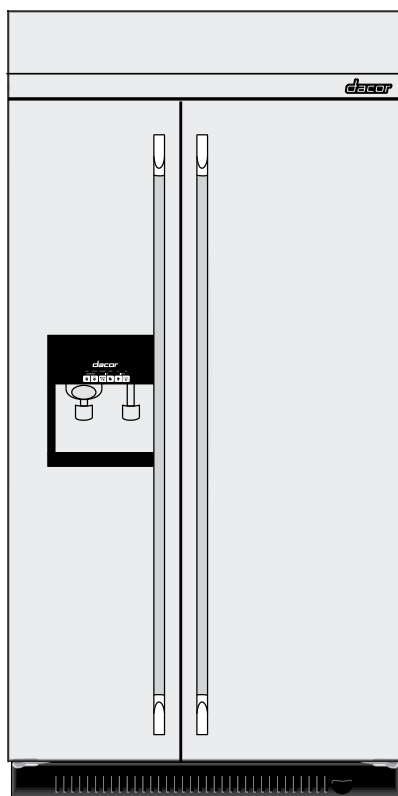

Style Varies

Model EF42DBSS Shown

Table of Contents

Important Safety Instructions	1
Important Information	2
Model Identification	2
Before Use	3
Refrigerator Operation	3-12
Care and Cleaning	13-14
Troubleshooting	15-17
Product Data Sheets	18
Warranty and Service	19
Notes	20



To Our Valued Customer:

Congratulations on your purchase of the very latest in Dacor® products! Our unique combination of features, style and performance make us The Life of the Kitchen™, and a great addition to your home.

In order to familiarize yourself with the controls, functions, and full potential of your new Distinctive Appliance, we suggest that you thoroughly read this use and care manual, beginning with the **Important Safety Instructions** section.

All Dacor appliances are designed and manufactured with quality and pride, while working within the framework of our company value. Should you ever experience a problem with your product, please first check the **Before You Call for Service** section of this manual for guidance. It provides useful suggestions and remedies prior to calling for service.

Valuable customer input helps us to continuously improve our products and services, so please feel free to contact our Customer Service Team for assistance with any of your product support needs.

Dacor Customer Service Team
1440 Bridge Gate Drive
Diamond Bar, CA 91765

Telephone: (800) 793-0093
Fax: (626) 403-3130
Hours of Operation: Monday through Friday
6:00 A.M. to 5:00 P.M. Pacific Time
Web Site: www.Dacor.com

Thank you for choosing Dacor for your home. We are a company built by families for families and we are dedicated to serving yours. We are confident that your new Dacor product will deliver a high level of performance and enjoyment for many years to come.

Sincerely,

The Dacor Customer Service Team

Important Safety Instructions

Your safety and the safety of others are very important.

We have provided many important safety messages in this manual and on your appliance. Always read and obey all safety messages.



This is the safety alert symbol.

This symbol alerts you to potential hazards that can kill or hurt you and others.

All safety messages will follow the safety alert symbol and either the word "DANGER" or "WARNING."

These words mean:

! DANGER

You can be killed or seriously injured if you don't immediately follow instructions.

! WARNING

You can be killed or seriously injured if you don't follow instructions.

All safety messages will tell you what the potential hazard is, tell you how to reduce the chance of injury, and tell you what can happen if the instructions are not followed.

IMPORTANT SAFETY INSTRUCTIONS

WARNING: To reduce the risk of fire, electric shock, or injury when using your refrigerator, follow these basic precautions:

- Plug into a grounded 3 prong outlet.
- Do not remove ground prong.
- Do not use an adapter.
- Do not use an extension cord.
- Disconnect power before servicing.
- Replace all parts and panels before operating.
- Remove doors from your old refrigerator.
- Use nonflammable cleaner.
- Keep flammable materials and vapors, such as gasoline, away from refrigerator.
- Use two or more people to move and install refrigerator.
- Disconnect power before installing ice maker (on ice maker kit ready models only).
- Use a sturdy glass when dispensing ice (on some models).

SAVE THESE INSTRUCTIONS

Proper Disposal of Your Refrigerator

! WARNING

Suffocation Hazard

Remove doors from your old refrigerator.

Failure to do so can result in death or brain damage.

IMPORTANT: Child entrapment and suffocation are not problems of the past. Junked or abandoned refrigerators are still dangerous, even if they sit out for "just a few days." If you are getting rid of your old refrigerator, please follow the instructions below to help prevent accidents.

Before you throw away your old refrigerator or freezer:

- Take off the doors.
- Leave the shelves in place so children may not easily climb inside.

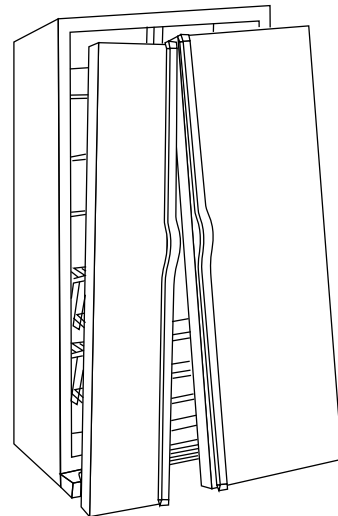

Important Information

Installer: Please leave this guide with this appliance.

Consumer: Please read and keep this use and care manual for future reference. This guide provides proper use and maintenance information. **Keep this guide and the sales receipt and/or cancelled check in a safe place for future reference. Proof of original purchase date is needed for warranty service.**

IMPORTANT: If you receive a damaged product, immediately contact your dealer or builder. Do not install or use a damaged appliance.

If you have any questions, call:

Dacor Customer Service Team

1-800-793-0093 (U.S.A. and Canada)

Monday — Friday 6:00 AM to 5:00 PM Pacific Time

Web site: www.Dacor.com

Have complete model and serial number identification of your refrigerator ready. These numbers are found on a serial number label, located on the right side of the refrigerator liner. Record these numbers on this page for easy access.

Model Number _____

Serial Number _____

Date of Purchase _____

For service and warranty information, see page 19.

Since Dacor constantly improves the quality and performance of our products, we may need to make changes to the appliance without revising this manual.

Model Identification

EF42DBSS and EF48DBSS:
42" and 48" dispenser models
with all stainless steel finish

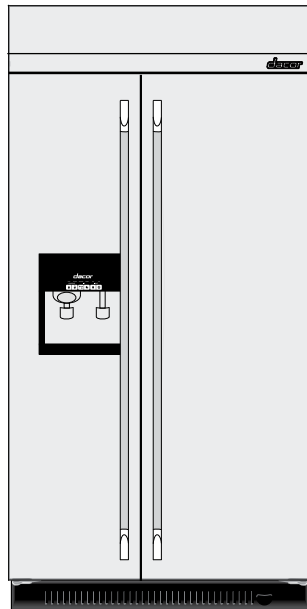

IF42DBOL and IF48DBOL:
42" and 48" dispenser models
designed for installation of
custom panels and handles



EF42NBSS and EF48NBSS:
42" and 48" non-dispensing
models with all stainless steel
finish

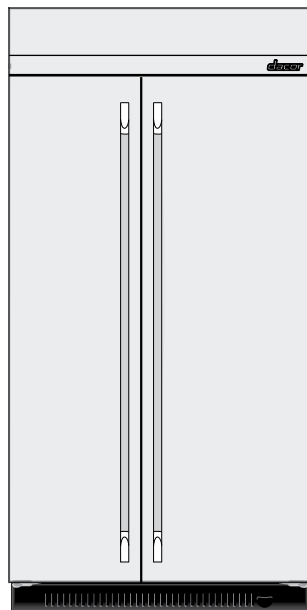

IF42NBOL and IF48NBOL:
42" and 48" non-dispensing
models designed for
installation of custom panels
and handles



Before Use

Remove the Packaging

- If the ice storage bin is located on the door, remove the temporary shield from underneath the ice storage bin. See *Ice Maker and Storage Bin*.
- Remove tape and glue residue from surfaces before turning on the refrigerator. Rub a small amount of liquid dish soap over the adhesive with your fingers. Wipe with warm water and dry.
- Do not use sharp instruments, rubbing alcohol, flammable fluids or abrasive cleaners to remove tape or glue. These products can damage the surface of your refrigerator. For more information, see *Important Safety Instructions* on page 1.
- Dispose of/recycle all packaging materials.

Clean Before Using

After you remove all of the packaging materials, clean the inside of your refrigerator before using it. See the cleaning instructions in *Care and Cleaning*.

Important information to know about glass shelves and covers:

Do not clean glass shelves or covers with warm water when they are cold. Shelves and covers may break if exposed to sudden temperature changes or impact, such as bumping. For your protection, tempered glass is designed to shatter into many small, pebble-size pieces. This is normal. Glass shelves and covers are heavy. Use special care when removing them to avoid impact from dropping.

Refrigerator Operation

Turning the Main Power Switch On/Off

⚠ WARNING



Electrical Shock Hazard

- Plug into a grounded 3 prong outlet.
- Do not remove ground prong.
- Do not use an adapter.
- Do not use an extension cord.
- Failure to follow these instructions can result in death, fire, or electrical shock.

⚠ WARNING



Explosion Hazard

- Keep flammable materials and vapors, such as gasoline, away from refrigerator.
- Failure to do so can result in death, explosion, or fire.

If you need to turn the power to your refrigerator on or off, you must remove the top grille assembly to access the power switch. Turn the power to the refrigerator off when cleaning your refrigerator or changing light bulbs.

Removing the Top Grille

1. Grasp both ends of the top grille.
2. Push the top grille straight up, then pull straight out. Lay the grille on a soft surface.

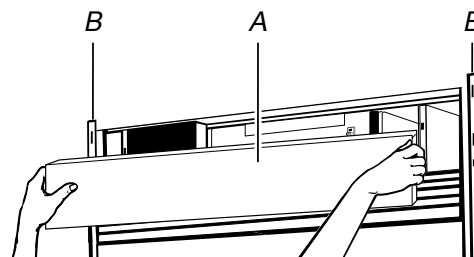

A. Top grille
B. Cabinet side trim

Replacing the Top Grille

1. Insert the top grille hooks (located on the back of the top grille) into the slots on the side trim.
2. Pull the grille down slightly to lock into place.

To Turn the Main Power Switch On or Off:

1. Remove the top grille.
2. Press the main power switch to the **ON** or **OFF** position.
3. Replace the top grille.

IMPORTANT: Be sure the main power switch is set to the On position after cleaning refrigerator or changing light bulbs.

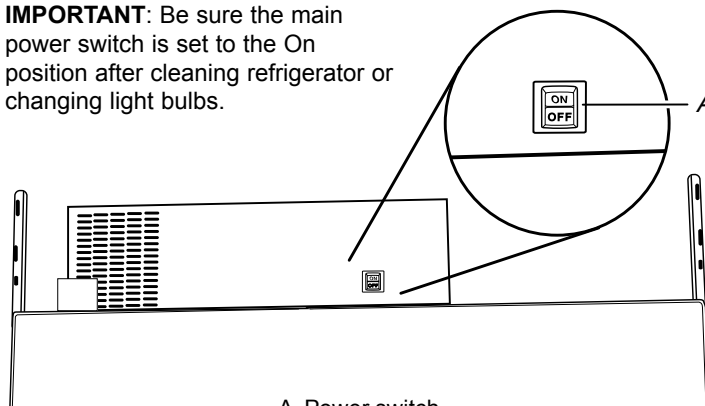

A. Power switch

Refrigerator Operation

Water Supply Requirements

Read all directions before you begin.

IMPORTANT:

- When your refrigerator was installed, the water connection from the water source should have been connected to your refrigerator. If your refrigerator is not connected to a water source, see *Connect the Water Supply* in the installation instructions. If you have any questions about your water connection, see the *Troubleshooting* section or call a licensed, qualified plumber.
- If you turn the refrigerator on before the water line is connected, turn the ice maker **OFF**. See *Ice Maker and Storage Bin* on page 8.
- All installations must meet local plumbing code requirements.

Water Pressure

A cold water supply with water pressure between 30 and 120 psi (207 and 827 kPa) is required to operate the water dispenser and ice maker. If you have questions about your water pressure, see *Troubleshooting* or call a licensed, qualified plumber.

Reverse Osmosis Water Supply

IMPORTANT: The pressure of the water supply coming out of a reverse osmosis system going to the water inlet valve of the refrigerator needs to be between 30 and 120 psi (207 and 827 kPa).

If a reverse osmosis water filtration system is connected to your cold water supply, the water pressure to the reverse osmosis system needs to be a minimum of 40 psi (276 kPa).

If the water pressure to the reverse osmosis system is less than 40 psi (276 kPa):

- Check to see whether the sediment filter in the reverse osmosis system is blocked. Replace the filter if necessary.
- Allow the storage tank on the reverse osmosis system to refill after heavy usage.
- If your refrigerator has a water filter, it may further reduce the water pressure when used in conjunction with a reverse osmosis system. Remove the water filter. See *Replacing the Water Filter* on page 14.

If you have questions about your water pressure, call a licensed, qualified plumber.

Water System Preparation

Please read before using the water system.

Immediately after installation, follow the steps below to make sure that the water system is properly cleaned.

1. Open the freezer door and turn off the ice maker.

For non-dispensing models, lift the ice maker cover, then lift up the wire shutoff arm as shown below.

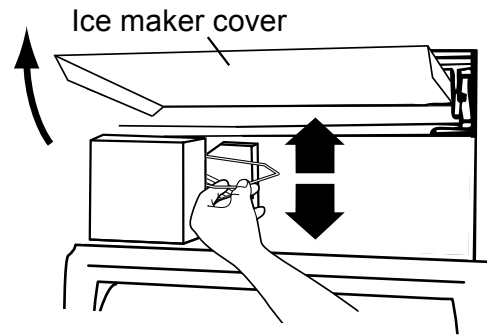

For dispensing models, move the switch to the **OFF** (right) setting as shown. The **ON/OFF** switch is located on the top right side of the freezer compartment. See below.

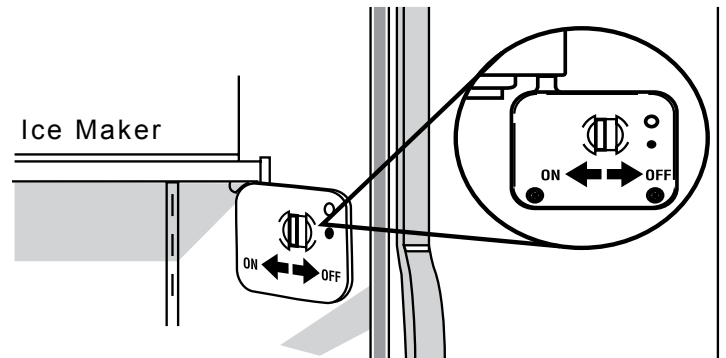

NOTE: If your model has a base grille filter system, make sure the base grille filter is properly installed and the cap is in the horizontal position.

Do not use with water that is microbiologically unsafe or of unknown quality without adequate disinfection before or after the system. Systems certified for cyst reduction may be used on disinfected waters that may contain filterable cysts.

2. Use a sturdy container to depress the water dispenser bar until the water begins to flow. Flush the water system by dispensing and discarding 6 qt (5.7 L) of water. Cleaning the system will take approximately 3 to 4 minutes and will help clear air from the line. Additional flushing may be required in some households.

NOTE: As air is cleared from the system, water may spurt out of the dispenser.

3. Open the freezer door and turn on the ice maker. For non-dispensing models, lower the wire shutoff arm. For dispensing models, move the switch to the **ON** (left) position.
 - Allow 24 hours to produce the first batch of ice.
 - Discard the first three batches of ice produced.
 - Depending on your model, you may want to select the maximum ice feature to increase the production of ice.

Refrigerator Operation

Normal Operating Sounds

Your new refrigerator may make sounds that your old one didn't make. Because the sounds are new to you, you might be concerned about them. Most of the new sounds are normal. Hard surfaces, such as the floor, walls and cabinets, can make the sounds seem louder. The following describes the kinds of sounds and what may be making them.

- If your refrigerator is equipped with an ice maker, you will hear a buzzing sound when the water valve opens to fill the ice maker for each cycle.
- Your refrigerator is designed to run more efficiently to keep your food items at the desired temperatures and to minimize energy usage. The high efficiency compressor and fans may cause your refrigerator to run longer than your old one. You may also hear a pulsating or high-pitched sound from the compressor or fans adjusting to optimize performance.
- You may hear the evaporator fan motor circulating air through the refrigerator and freezer compartments. The fan speed may increase as you open the doors or add warm food.
- Rattling noises may come from the flow of refrigerant, the water line or items stored on top of the refrigerator.
- Water dripping on the defrost heater during a defrost cycle may cause a sizzling sound.
- As each cycle ends, you may hear a gurgling sound due to the refrigerant flowing in your refrigerator.
- Contraction and expansion of the inside walls may cause a popping noise.
- You may hear air being forced over the condenser by the condenser fan.
- You may hear water running into the drain pan during the defrost cycle.

Ensuring Proper Air Circulation

In order to ensure proper temperatures, you need to permit airflow between the two sections. Cold air enters the bottom of the freezer section and moves up. It then enters the refrigerator section through the top vent. Air then returns to the freezer as shown.

Do not block any airflow vents. If the vents are blocked, airflow will be obstructed and temperature and moisture problems may occur.

IMPORTANT: Because air circulates between both sections, any odors formed in one section will transfer to the other. You must thoroughly clean both sections to eliminate odors. To avoid odor transfer and drying out of food, wrap or cover foods tightly.

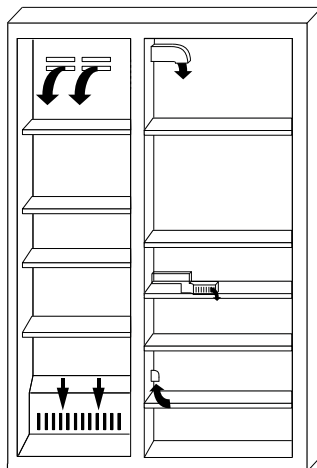

Setting the Controls

The control panel is located inside the refrigerator compartment on the ceiling.

IMPORTANT:

- The refrigerator control adjusts the refrigerator compartment temperature. The freezer control adjusts the freezer compartment temperature.
- Wait 24 hours after you turn on the refrigerator before you put food into it. If you add food before the refrigerator has cooled completely, your food may spoil.

NOTE: Adjusting the refrigerator and freezer controls to a lower (colder) setting will not cool the compartments any faster.

- If the temperature is too warm or too cold in the refrigerator or freezer, first check the air vents to be sure they are not blocked before adjusting the controls.
- The preset settings should be correct for normal household usage. The controls are set correctly when milk or juice is as cold as you like and when ice cream is firm.
- The actual temperature may differ from the display when a door is open for an extended period of time.

NOTE: The factory recommended settings are 0°F (-18°C) for the freezer and 37°F (3°C) for the refrigerator.

Turning the Refrigerator On or Off

- Press and hold the **POWER ON-OFF** key for 2 seconds. When the refrigerator comes on, the freezer and refrigerator temperature displays will light.

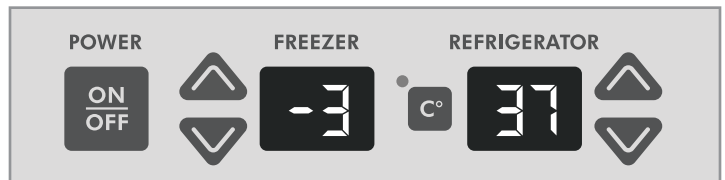

- To turn the refrigerator off, press and hold the **POWER ON-OFF** key for 2 seconds. The freezer and refrigerator temperature displays will go dark when the refrigerator is off.

NOTE:

- After the refrigerator is turned on, the Over Temperature Audio Alarm and indicator light will activate every 1½ hours until the refrigerator and freezer temperatures are below 48°F (9°C) and 15°F (-9°C), respectively, or until the alarm is turned off. To turn off the audio alarm and indicator light, see *Master Alarm Reset* on page 7.

Over Temperature Indicator Light

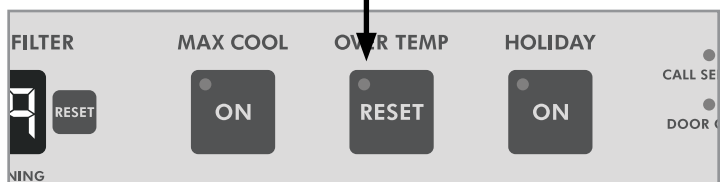

- The **Power ON-OFF** key on the control panel shuts down the cooling system, fans and compressors as well as the control panel lights. To turn the power off completely, use the main power switch located behind the top grille. See page 3.

Refrigerator Operation



Setting the Controls (continued)

Setting the Temperature Scale

- The indicator light, next to the C° button, is lit when the temperature scale for the freezer and refrigerator displays is set to Celsius. To change the displays to Celsius (or back to Fahrenheit), press the C° button.

Celsius Indicator Light

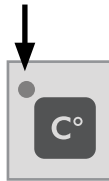

Adjusting the Temperature Setting

NOTE: Wait at least 24 hours between adjustments. Re-check the temperatures before other adjustments are made.

To adjust the temperature setting:

- Press the refrigerator or freezer **UP** (▲) or **DOWN** (▼) key until the desired temperature is reached.

NOTE: The adjustable temperature range for the freezer is -5°F to 6°F (-21°C to -14°C). The adjustable temperature range for the refrigerator is 34°F to 46°F (1°C to 8°C).

Use the table below for guidance if you need to change the temperature.

CONDITION/ REASON:	TEMPERATURE ADJUSTMENT:
REFRIGERATOR too cold Not set correctly for conditions	REFRIGERATOR Control 1° higher
REFRIGERATOR too warm High use or room very warm	REFRIGERATOR Control 1° lower
FREEZER too cold Not set correctly for conditions	FREEZER Control 1° higher
FREEZER too warm/too little ice. High use or heavy ice use	FREEZER Control 1° lower

Water Filter Monitor

Do not use with water that is microbiologically unsafe or of unknown quality without adequate disinfection before or after the system. Systems certified for cyst reduction may be used on disinfected waters that may contain filterable cysts.

The water filter monitor will help you know when it is time to change your filter. To change the filter, see the *Replacing the Water Filter* on page 14.

DISPLAY READING:	STATUS:
99 percent	New filter installed
10 percent	Order replacement filter
0 percent or flow decreases	Replace filter

A new water filter should display a reading of 99%. The reading in the display will decrease as the filter life is used. When the display reads 10%, it is time to order a replacement water filter. It is recommended that you replace the filter when the filter display changes to 0% OR when water flow to your water dispenser or ice maker decreases noticeably. See *Replacing the Water Filter* on page 14.

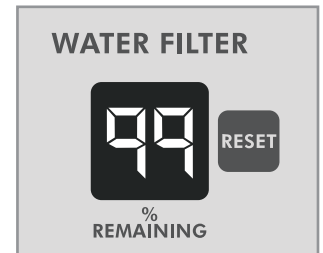

After replacing the water filter, press **RESET** and hold for 2 seconds to change the water filter display to 99 percent.

Max Cool

The Max Cool feature assists with periods of heavy ice usage, full grocery loads or temporarily warm room temperatures.

Press the **MAX COOL** key to turn on the Max Cool feature. The Max Cool indicator light will remain on for 24 hours unless manually turned off.

NOTE: The refrigerator temperature display will remain at 34°F (1°C) and the freezer temperature display will remain at -5°F (-21°C) while the Max Cool feature is on. After 24 hours, the refrigerator will automatically return to the previous temperature settings.

Max Cool Indicator Light

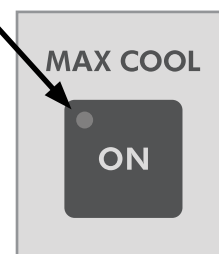

Refrigerator Operation

Holiday Mode

The Holiday Mode feature is designed for the traveler or for those whose religious observances require turning off the lights and ice maker. When you select this feature, the ice maker will be disabled and the interior lights will turn off. The temperature settings remain unchanged. On some models, the Holiday Mode feature doesn't disable the ice and water dispenser. For these models the lock button can be used to disable the ice and water functions, but depressing the ice or water lever will still turn on the dispenser light. For most efficient refrigerator operation, it is recommended to exit the Holiday Mode when it is no longer required.

- Press the **HOLIDAY** key to turn on the Holiday mode feature. This feature will remain on until you press the **HOLIDAY** key again.

Holiday Mode Indicator Light

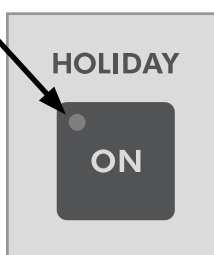

NOTE: If the Max Cool feature is selected prior to turning on the Holiday mode, the temperature settings will remain at 34°F (1°C) and -5°F (-21°C) for the refrigerator and freezer compartments, until the Max Cool feature time (24 hours) is up. The refrigerator will then return to the previous temperature settings chosen prior to turning on the Max Cool feature, but the lights and ice maker will remain off until the Holiday mode key is pressed again.

Alarms

Over Temperature

The Over Temperature feature is designed to let you know when either the refrigerator temperature rises above 48°F (9°C) or the freezer temperature rises above 15°F (-9°C) for longer than 1½ hours. The audio alarm will shut off automatically when the temperature returns to normal, but the indicator light will continue to flash to let you know that an over temperature condition has occurred.

If the over temperature condition is still present when an Over Temperature Reset is performed, the indicator light will continue to reactivate every 1½ hours until refrigerator and freezer temperatures are below 48°F (9°C) and 15°F (-9°C), respectively.

IMPORTANT: If the Over Temperature Alarm activates, your food may spoil. See the *Power Interruption* section on page 12. Minimize door openings until temperatures return to normal.

NOTE: To deactivate the audio alarm and indicator light, see *Master Alarm Reset*.

Over Temperature Indicator Light

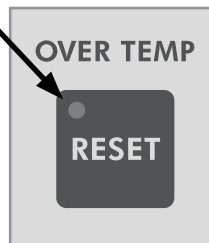

Door Open

The Door Open indicator light will flash, an alarm will sound and the interior lights will turn off when a door has been open for longer than 10 minutes. When the door is closed, the audio alarm will reset and turn off, but the Door Open indicator light will continue to flash until the temperature is equal to or below 45°F (7°C) and 15°F (-9°C) for the refrigerator and freezer compartments, respectively.



NOTE: To deactivate the audio alarm and indicator light, see *Master Alarm Reset*.

Call Service

If the **Call Service** indicator light is flashing, call for service. See the *Warranty and Service* section for information.



NOTE: To deactivate the audio alarm and indicator light, see *Master Alarm Reset* below.

Master Alarm Reset

Pressing the **OVER TEMPERATURE RESET** key will shut off the audio alarm, but this does not affect the indicator light the first time **OVER TEMPERATURE RESET** is pressed. The indicator light will shut off once **OVER TEMPERATURE RESET** is pressed the second time. The audio alarm will not sound again for the current condition that caused the alarm until a new condition occurs or until a master alarm reset is performed.

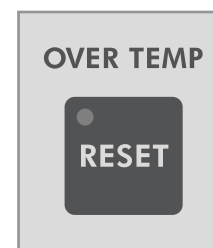

A master alarm reset can be performed by pressing the **POWER ON-OFF** key twice or by turning the power to the refrigerator off and on again. See *Turning the Main Power Switch On/Off* on page 3. The indicator light will reactivate after the **OVER TEMPERATURE RESET** key is pressed if the condition that caused the alarm is still present. See *Over Temperature, Door Open or Call Service* above.

Water and Ice Dispensers

(Dispensing Models Only)

⚠ WARNING



Cut Hazard

Use a sturdy glass when dispensing ice.

Failure to do so can result in cuts.

Depending on your model, you may have one or more of the following options: the ability to select either crushed or cubed ice, a special light that turns on when you use the dispenser, or a lock option to avoid unintentional dispensing.

Refrigerator Operation

Water and Ice Dispensers

The Ice Dispenser

Ice dispenses from the ice maker storage bin in the freezer. When the dispenser lever is pressed:

- A trap door opens in a chute between the dispenser and the ice bin. Ice moves from the bin and falls through the chute.
- When you release the dispenser lever, the trap door closes and the ice dispensing stops. The dispensing system will not operate when the freezer door is open.

Some models dispense both cubed and crushed ice. Before dispensing ice, select which type of ice you prefer. The key controls are designed for easy use and cleaning.

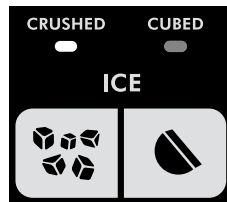

For crushed ice, cubes are crushed before they are dispensed. This may cause a slight delay when dispensing crushed ice. Noise from the ice crusher is normal, and pieces of ice may vary in size. When changing from crushed to cubed, a few ounces of crushed ice will be dispensed along with the first cubes.

To Dispense Ice:

1. If the ice storage bin is located on the door, remove the temporary shield from underneath the ice storage bin. See *Ice Maker and Storage Bin*.
2. Press button for the desired type of ice.
3. Press a sturdy glass against the ice dispenser lever. Hold the glass close to the dispenser opening so ice does not fall outside of the glass.

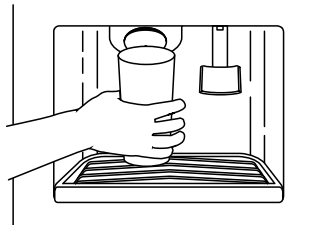

IMPORTANT: You do not need to apply a lot of pressure to the lever in order to activate the ice dispenser. Pressing hard will not make the ice dispense faster or in greater quantities.

4. Remove the glass to stop dispensing.

NOTE: The first few batches of ice may have an off-flavor from new plumbing and parts. Throw the ice away. Also, take large amounts of ice from the ice bin, not through the dispenser.

The Water Dispenser

If you did not flush the water system when the refrigerator was first installed, press the water dispenser bar with a sturdy glass or jar until you draw and discard 6 qt (5.7 L) or approximately 3 to 4 minutes of water after water begins dispensing. It will take 2 to 3 minutes for the water to begin dispensing. The water you draw and discard cleans the system and helps clear air from the lines. Allow several hours for the refrigerator to cool down and chill water.

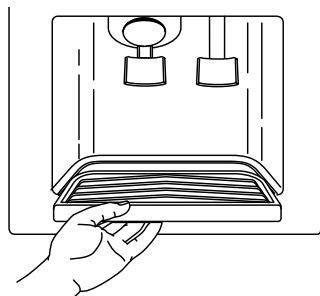

IMPORTANT: Depending on your model, the small removable tray at the bottom of the dispenser is designed to catch small spills and allow for easy cleaning. There is no drain in the tray. The tray can be removed from the dispenser and carried to the sink to be emptied or cleaned.

To Dispense Water:

1. Press a sturdy glass against the water dispenser lever.
2. Remove the glass to stop dispensing.

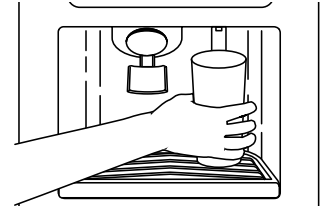

NOTE: Water may have an off-flavor if you do not use the dispenser periodically. Dispense enough water every week to maintain a fresh supply.

Dispenser Light

The dispenser area has a light. It can be turned on manually by pressing the **ON** key (touch pad or rocker switch).

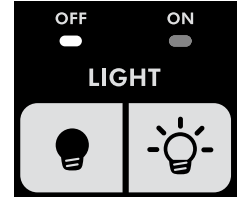

Whenever you use the dispenser, the lever will automatically turn the light on also.

NOTE: See page 13 for information on changing the dispenser light bulb.

Dispenser Lock

The dispenser can be turned off for easy cleaning or to avoid unintentional dispensing by small children and pets.

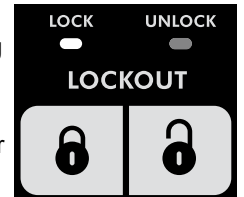

NOTE: The lock feature does not shut off power to the refrigerator, to the ice maker, or to the dispenser light. It simply deactivates the dispenser levers.

- To turn off the dispenser, press the **LOCK** key. The indicator will appear above the **LOCK** key and the ice and water dispensers will not work.
- To unlock the dispenser, press the **UNLOCK** key until the indicator appears. Then continue to dispense ice or water as usual.

Ice Maker and Storage Bin

Non-Dispensing Models

To Turn the Ice Maker On or Off:

The On/Off switch for the ice maker is a wire shutoff arm located on the side of the ice maker.

1. To turn the ice maker on, lift the ice maker cover, then lower the wire shutoff arm.

NOTE: Your ice maker has an automatic shutoff. As ice is made, the ice cubes will fill the ice storage bin and the ice cubes will raise the wire shutoff arm to the off (arm up) position.

2. To manually turn the ice maker off, lift the wire shutoff arm to the off (arm up) position and listen for the click to make sure the ice maker will not continue to operate.

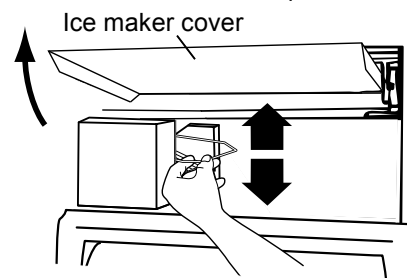

Refrigerator Operation

To Remove and Replace the Ice Bin (non-dispensing models):

1. Flip up the ice maker cover.

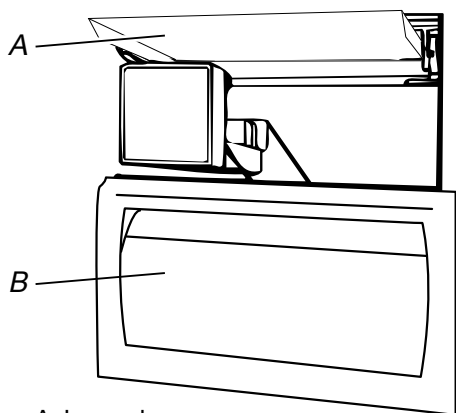

A. Ice maker cover
B. Ice bin

2. Lift the wire shutoff arm so it clicks into the off (up) position. Ice can still be dispensed, but no more can be made.
3. Lift up the front of the storage bin and pull the ice bin forward.
4. Replace the bin by pushing it in all the way or the dispenser will not work. Push the wire shutoff arm down to the on position to restart ice production. Make sure the door is closed tightly.

Dispensing Models

To Turn the Ice Maker On/Off:

1. The On/Off switch is located on the top right side of the freezer compartment.

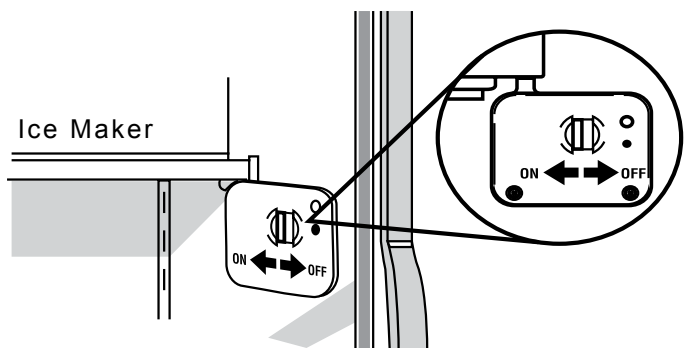

2. To turn the ice maker on, slide the control to the **ON** (left) position.

NOTE: Your ice maker has an automatic shutoff. The ice maker sensors will automatically stop ice production, but the control will remain in the **ON** (left) position.

3. To manually turn the ice maker off, slide the control to the **OFF** (right) position.

To Remove and Replace the Ice Storage Bin (dispensing models):

1. Hold the base of the storage bin (located on the back of the freezer door) with both hands and press the release button to lift the storage bin up and out.



NOTE: It is not necessary to turn the ice maker control to the **OFF** (right) position when removing the storage bin. The sensor cover ("flipper door") on the left wall of the freezer stops the ice maker from producing ice if the door is open or the storage bin is removed.

2. Replace the storage bin on the door and push down to make sure it is securely in place.

Clean the Ice Storage Bin

1. Empty the ice container. Use warm water to melt the ice if necessary.

NOTE: Do not use anything sharp to break up the ice in the bin or bucket. This can cause damage to the ice container and the dispenser mechanism.

2. Wash ice bin with a mild detergent, rinse well and dry thoroughly. Do not use harsh or abrasive cleaners or solvents.

IMPORTANT:

- Allow 24 hours to produce the first batch of ice. Allow 3 days to completely fill ice container. Discard the first three batches of ice produced to avoid impurities that may be flushed out of the system.
- The quality of your ice will be only as good as the quality of the water supplied to your ice maker.
- Avoid connecting the ice maker to a softened water supply.
- Water softener chemicals (such as salt) can damage parts of the ice maker and lead to poor quality ice. If a softened water supply cannot be avoided, make sure the water softener is operating properly and is well maintained.
- It is normal for the ice cubes to be attached at the corners.
- They will break apart easily.
- For non-dispensing models, do not force the ice maker wire shutoff arm up or down.
- Do not store anything on top of the ice maker or in the ice storage bin/bucket.

Refrigerator Operation

Refrigerator Storage

Important information to know about glass shelves and covers:

Do not clean glass shelves or covers with warm water when they are cold. Shelves and covers may break if exposed to sudden temperature changes or impact, such as bumping. For your protection, tempered glass is designed to shatter into many small, pebble-size pieces. This is normal. Glass shelves and covers are heavy. Use special care when removing them to avoid impact from dropping.

The shelves and compartments in your refrigerator are adjustable and/or removable to meet your individual storage needs and to make them easier to clean.

Storing similar food items together in your refrigerator and adjusting the shelves compartments to fit different heights of items will make finding the exact item you want easier. It will also reduce the amount of time the refrigerator door is open, and help save energy.

Shelves and Shelf Frames

To remove and replace a shelf/frame:

1. Remove the shelf/frame by tilting it up at the front and lifting it out of the shelf supports. Pull the shelf straight out.
2. Replace the shelf/frame by guiding the rear shelf hooks into the shelf supports. Tilt the front of the shelf up until the rear shelf hooks drop into the shelf supports.
3. Lower the front of the shelf and check to make sure that the shelf is securely in position.

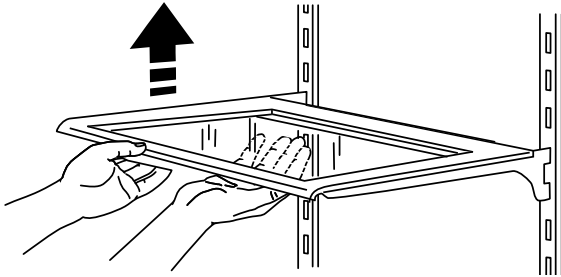

Ingredient Care Center

The control for the ingredient care center (see location in diagram at right) adjusts the storage temperature of the ingredient care center pan. Cold air flows into the pan through the air duct between the freezer and the refrigerator. Setting the controls allows more or less cold air through the air duct.

To Adjust the Ingredient Care Center:

1. Choose a setting based on the item to be stored in the pan.
2. Push the button that corresponds to that setting.
3. The indicator light for that setting will illuminate to verify that the pan is ready to be loaded.

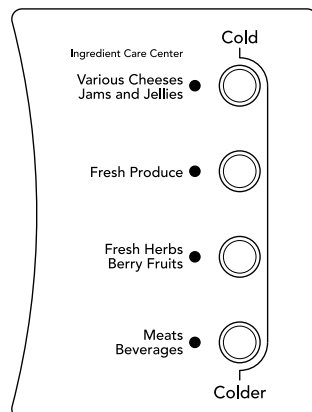

Remove and Replace the Ingredient Care Center Cover:

1. Remove food from ingredient care center cover. Pull drawer out about 4" (10.16 cm). Reach under the glass shelf with both hands and lift gently upward until back of shelf is free. Tilt shelf at an angle and remove shelf from refrigerator being careful not to bump the glass.
2. Replace the cover by holding the glass shelf firmly with both hands, tilt the shelf at an angle and position it above the support rails. Place shelf gently on support rails on side wall.

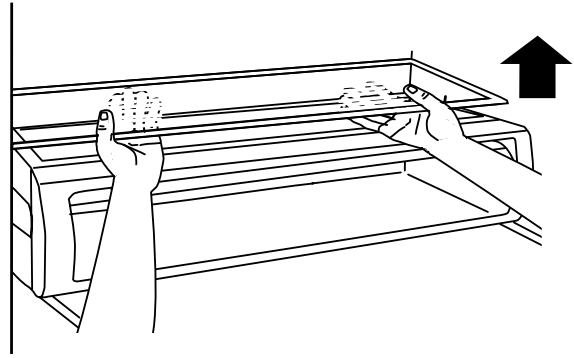

Crispers and Covers

To remove and replace the crispers:

1. Slide the crisper drawer straight out to the stop. Lift the front of the drawer with one hand while supporting the bottom of the drawer with your other hand and slide the drawer out the rest of the way.
2. To replace the crisper drawer, place the drawer onto slides and push the drawer back until securely in position.
3. Carefully test the crisper drawer to make sure it has been replaced properly.

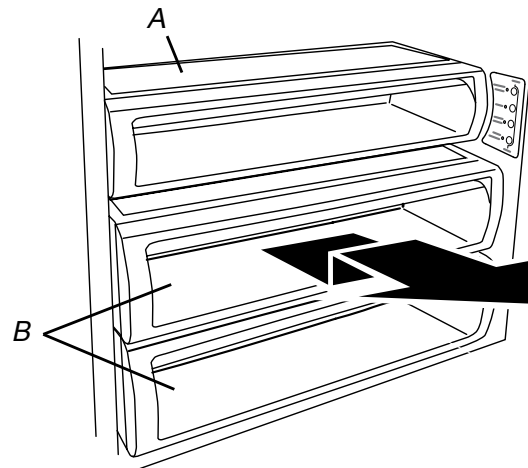

A. Ingredient care center

B. Crispers

To clean the crisper covers:

To clean the top crisper cover, remove the ingredient care center located above it.

To clean the bottom crisper cover, first remove the top crisper drawer.

Refrigerator Operation

Door Utility Bin

The utility bin can be placed in any position on the refrigerator door.

To remove and replace the utility bin:

1. Remove the utility bin by grasping both ends and lifting compartment up and out.
2. Replace the bin by sliding it in above the desired support and pushing it down until it stops.

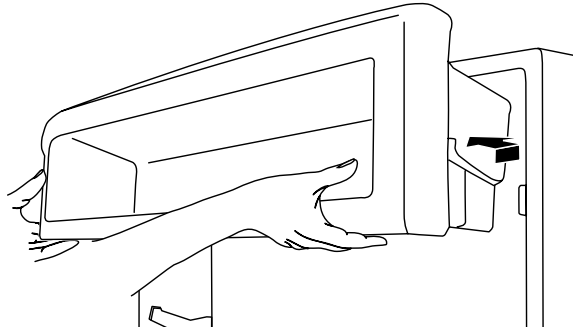

Gallon Door Bin

The adjustable gallon door bin can hold gallon size containers.

To install the gallon door bin:

NOTE: The gallon door bin can only be placed on the lower support.

1. Position the gallon door bin above lowest door adjustment slot.
2. Push down to secure it.
3. Adjust other bins, as necessary to allow for milk or beverage container height.

Standard Door Bins

The adjustable standard door bins can hold 2-liter bottles.

To remove and replace the door bins:

1. Remove the bin by lifting it up and pulling it out.
2. Replace the bin by sliding it in above the desired support and pushing it down until it stops.

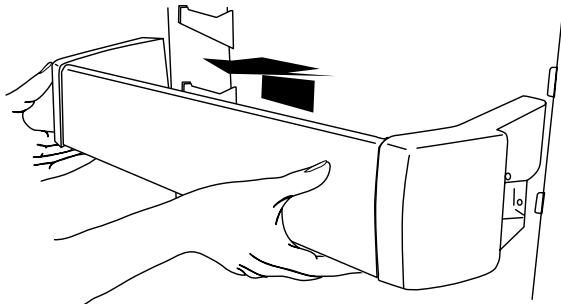

Fresh Food Storage Information

- The fresh food compartment of a refrigerator should be kept between 34°-40°F (1°-4°C) with an optimum temperature of 37°F (3°C).
- Avoid overcrowding the refrigerator shelves. This reduces the circulation of air around the food and results in uneven cooling.

Fruits and Vegetables

- Storage in the crisper drawers traps humidity to help preserve the fruit and vegetable quality for longer time periods.
- Sort fruits and vegetables before storage and use bruised or soft items first. Discard those showing signs of decay.
- Always wrap odorous foods such as onions and cabbage so the odor does not transfer to other foods.
- While vegetables need a certain amount of humidity to remain fresh, too much humidity can shorten storage times (especially leafy vegetables). Drain vegetables well before storing.
- Wait to wash fresh produce until right before use.

Meat and Cheese

- Raw meat and poultry should be wrapped securely so leakage and contamination of other foods or surfaces does not occur.
- Occasionally mold will develop on the surface of hard cheeses (Swiss, Cheddar, Parmesan). In the interest of safety, discard cheese that is moldy.

Dairy Food

- Most dairy foods such as milk, yogurt, sour cream and cottage cheese have freshness dates on their cartons for appropriate length of storage. Store these foods in the original carton and refrigerate immediately after purchasing and after each use.

Freezer Storage

Freezer Shelf

To remove and replace the shelf:

1. Remove the shelf by lifting it up and pulling it straight out.
2. Replace the shelf by putting it over the supports and lowering it into place.

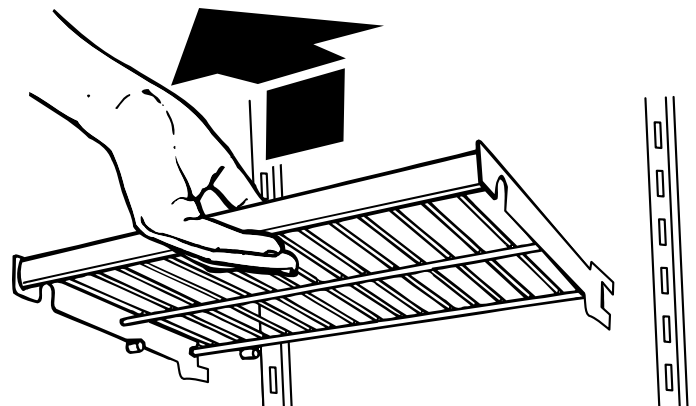

Refrigerator Operation

Freezer Baskets

The freezer baskets can be used to store bags of frozen fruits and vegetables that may slide off freezer shelves.

To remove and replace a freezer basket:

1. Pull the basket straight out to the stop.
2. Lift the front of the basket and slide it out the rest of the way.
3. Replace the basket by positioning it on the side wall guide rails. Lift the basket front slightly while pushing it past the guide rail stops and slide basket in the rest of the way.

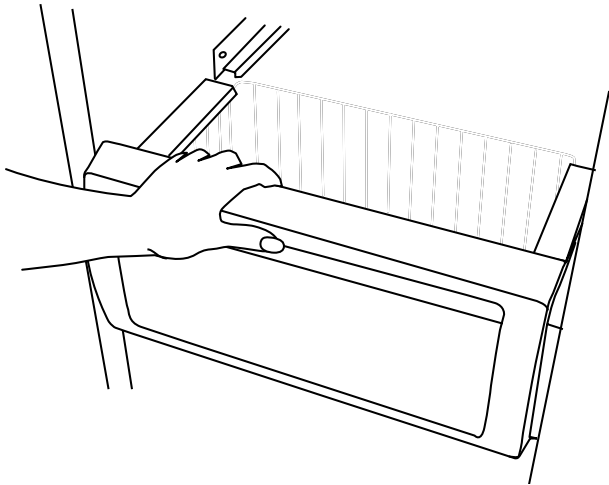

Frozen Food Storage Information

- The freezer compartment of a refrigerator should be kept at approximately 0°F (-18°C).
- A freezer operates more efficiently when it is at least two-thirds full.

Packaging Foods for Freezing

- To minimize dehydration and quality deterioration use aluminum foil, freezer wrap, freezer bags or airtight containers. Force as much air out of the packages as possible and be sure they are tightly sealed. Trapped air can cause the food to dry out, change color and develop an off-flavor (freezer burn).
- Wrap fresh meats and poultry with suitable freezer wrap prior to freezing.
- Do not refreeze meat that has completely thawed.

Loading the Freezer

- Avoid adding too much warm food to the freezer at one time. This overloads the freezer, slows the rate of freezing and can raise the temperature of frozen foods.
- Leave space between the packages so cold air can circulate freely, allowing food to freeze as quickly as possible.
- Avoid storing hard-to-freeze foods such as ice cream and orange juice on the freezer door shelves. These foods are best stored in the freezer interior where the temperature varies less with door openings.

Power Interruptions

If the power will be out for 24 hours or less, keep the door or doors closed to help food stay cold and frozen.

If the power will be out for more than 24 hours, do one of the following:

- Remove all frozen food and store it in a frozen food locker.
- Place 2 lbs (907 g) of dry ice in the freezer for every cubic foot (28 L) of freezer space. This will keep the food frozen for 2 to 4 days.
- If neither a food locker nor dry ice is available, consume or can perishable food at once.

IMPORTANT: A full freezer stays cold longer than a partially filled one. A freezer full of meat stays cold longer than a freezer full of baked goods. If you see that food contains ice crystals, it may be refrozen, although the quality and flavor may be affected. If the condition of the food is poor, dispose of it.

Vacation Care

Your refrigerator is equipped with the Holiday mode, which is designed for the traveler who wishes to turn off the lights and ice maker. By selecting this feature, the temperature settings remain unchanged, the ice maker will be disabled and the interior lights will turn off. For most efficient refrigerator operation, it is recommended to exit the Holiday mode when it is no longer required.

If You Choose to Leave the Refrigerator On While You're Away:

1. Use up any perishables and freeze other items.
2. Press the **HOLIDAY** key.
3. If your refrigerator has an automatic ice maker, shut off water supply to the ice maker.
4. Empty the ice bin.
5. When you return from vacation, press the **HOLIDAY** key to return to normal operation.



If You Choose to Turn the Refrigerator Off Before You Leave:

1. Remove all food from the refrigerator.
2. If your refrigerator has an automatic ice maker:
 - Turn off the water supply to the ice maker at least one day ahead of time.
 - When the last load of ice drops, raise the wire shutoff arm to the **OFF** (up) position.
3. Turn the power off. See *Turning the Refrigerator On or Off* on page 5.
4. Clean refrigerator, wipe it, and dry well.
5. Tape rubber or wood blocks to the tops of both doors to prop them open far enough for air to get in. This stops odor and mold from building up.

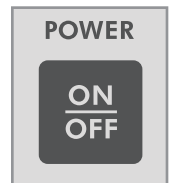

Care and Cleaning

Cleaning

⚠ WARNING



Explosion Hazard

Use nonflammable cleaner.

Failure to do so can result in death, explosion, or fire.

Important information to know about glass shelves and covers:

Do not clean glass shelves or covers with warm water when they are cold. Shelves and covers may break if exposed to sudden temperature changes or impact, such as bumping. For your protection, tempered glass is designed to shatter into many small, pebble-size pieces. This is normal. Glass shelves and covers are heavy. Use special care when removing them to avoid impact from dropping.

Both the refrigerator and freezer sections defrost automatically. However, clean both compartments about once a month to avoid build-up of odors. Wipe up spills immediately.

To Clean Your Refrigerator:

1. Remove the top grille and turn off the main power switch. See *Turning the Main Power Switch On/Off* on page 3.
2. Remove all removable parts from inside, such as shelves, crispers, etc.
3. Hand wash, rinse, and dry removable parts and interior surfaces thoroughly. Use a clean sponge or soft cloth and a mild detergent in warm water.
 - Do not use abrasive or harsh cleaners such as window sprays, scouring cleansers, flammable fluids, cleaning waxes, concentrated detergents, bleaches or cleansers containing petroleum products on plastic parts, interior and door liners or gaskets. Do not use paper towels, scouring pads or other harsh cleaning tools. These items can scratch or cause damage.
 - To help remove odors, you can wash interior walls with a mixture of warm water and baking soda (2 tbs to 1 qt [26 g to 0.95 L] of water).
4. Wash stainless steel and painted metal exteriors with a clean sponge or soft cloth and a mild detergent in warm water. Do not use abrasive or harsh cleaners, or cleaners containing chlorine. Dry thoroughly with a soft cloth. For additional protection against damage to painted metal exteriors, apply appliance wax (or auto paste wax) with a clean, soft cloth. Do not wax plastic parts.

NOTE: To keep your stainless steel surfaces looking like new and to remove minor scuffs or marks, you may use Dacor Stainless Steel Cleaner. Use it according to the directions on the bottle.

IMPORTANT: This cleaner is for stainless steel parts only! Do not allow the Stainless Steel Cleaner and Polish to come into contact with any plastic parts such as the trim pieces, dispenser covers or door gaskets. If accidental contact does occur, clean the plastic part with a sponge and mild detergent in warm water. Dry thoroughly with a soft cloth.

5. Clean the condenser coils located behind the top grille ventilation panel regularly. Coils may need to be cleaned as often as every other month. This may help save energy. Use a vacuum cleaner with an extended attachment to clean the condenser coils when they are dusty or dirty.
6. Turn the main power switch on and replace the top grille.

Changing the Light Bulbs

NOTE: Not all appliance bulbs will fit your refrigerator. Be sure to replace the bulb with one of the same size and shape. The dispenser light requires a heavy duty 10-watt bulb. All other lights require a 40-watt maximum appliance bulb. Replacement bulbs are available from your Dacor dealer or appliance store.

1. Remove the top grille and turn off the main power switch. See *Turning the Main Power Switch On/Off* on page 3.
2. Remove light shield when applicable as shown.

NOTE: To clean a light shield, wash it with warm water and a liquid detergent. Rinse and dry the shield well.

3. Remove light bulb and replace with one of the same size, shape and wattage.
4. Replace light shield when applicable as shown.
5. Turn the main power switch on and replace the top grille.

Dispenser Light (dispensing models only)

Reach through the dispenser area to remove and replace light bulb.

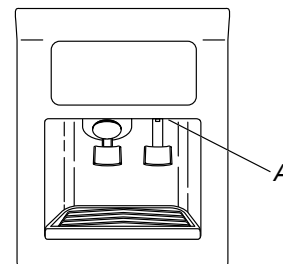

A. Dispenser Light

Refrigerator Control Panel Lights

Use a 1/4" hex nut-driver to remove and replace the light shield.

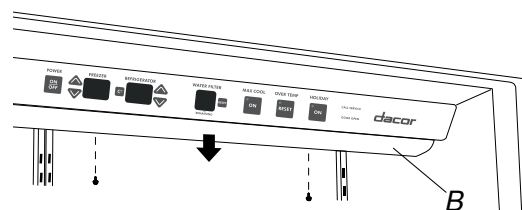

B. Light shield

Freezer and Crisper Lights

- Remove the light shield by grasping the top and bottom and squeezing in toward the center. Once the hooks on the shield are free from the freezer or crisper lining, remove the shield.
- Replace the light shield by squeezing the top and bottom toward the center and inserting the hooks into the slotted holes.

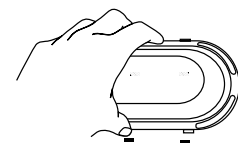

Care and Cleaning

Replacing the Water Filter

Do not use with water that is microbiologically unsafe or of unknown quality without adequate disinfection before or after the system. Systems certified for cyst reduction may be used on disinfected waters that may contain filterable cysts.

1. Locate the water filter cap in the front base grille. Rotate the cap counterclockwise to a vertical position and pull the cap and filter cartridge out through the base grille.

NOTE: There will be water in the filter. Some spilling may occur.

2. Remove the cap by sliding it off the end of the used filter. The cap will slide to the left or right.

IMPORTANT: Do not discard the cap. It is part of your refrigerator. Keep the cap to use with the replacement filter.

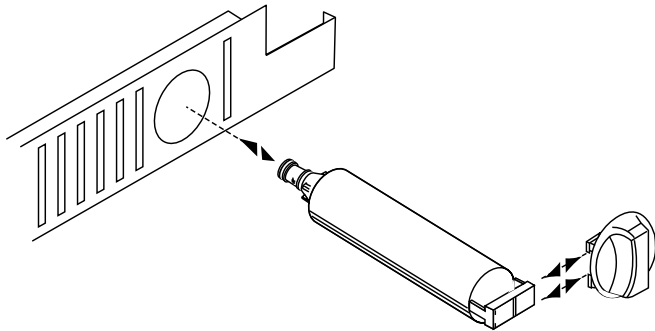

3. Take the new water filter out of its packaging and remove the protective cover from the O-rings. Discard the protective cover.

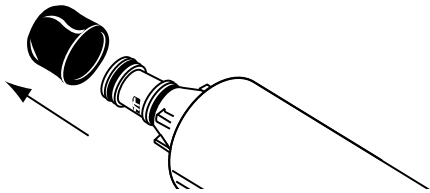

4. Slide the cap (removed in Step 2) onto the new filter. See illustration in Step 2.
5. With cap in the vertical position, push the new water filter into the base grille until it stops. Rotate the cap clockwise to a horizontal position. Flush the water system. See *Flushing the Water System After Replacing Filter*.

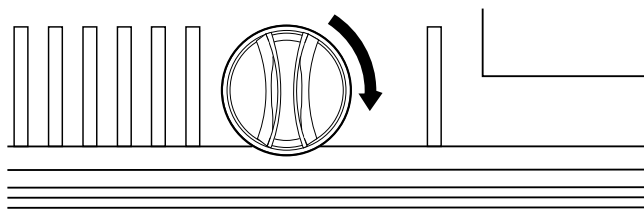

Flushing the Water System After Replacing Filter

Use a sturdy container to depress the water dispenser bar until the water begins to flow. Flush the water system by dispensing and discarding 6 qt (5.7 L) of water. Cleaning the system will take approximately 3 to 4 minutes and will help clear air from the line. Additional flushing may be required in some households.

NOTE: As air is cleared from the system, water may spurt out of the dispenser.

WATER FILTER CERTIFICATIONS

State of California
Department of Health Services
Water Treatment Device
Certificate Number

03 - 1551

Date Issued: January 21, 2003

Trademark/Model Designation	Replacement Elements	Rated Capacity
Whirlpool WF-NLC240V	NLC240V	240 gal
Whirlpool WF-LC400V	LC400V	400 gal

Manufacturer: Whirlpool Corp.

The water treatment device(s) listed on this certificate have met the testing requirements pursuant to Section 116830 of the Health and Safety Code for the following health related contaminants:

Microbiological Contaminants and Turbidity

Cysts
Turbidity

Inorganic/Radiological Contaminants

Asbestos
Lead
Mercury

Organic Contaminants

Atrazine
2,4-D
Benzene
p-dichlorobenzene
Toxaphene

Rated Service Flow: 0.5 gpm

Do not use where water is microbiologically unsafe or with water of unknown quality, except that systems

Using the Dispenser Without the Water Filter

You can run the dispenser without a water filter. Your water will not be filtered.

1. Remove the water filter.
2. Slide the cap off the end of the filter.
3. With the cap in the vertical position, insert the cap into the base grille until it stops.

IMPORTANT: Do not discard the cap. It is part of your refrigerator. Keep the cap to use with the replacement filter.

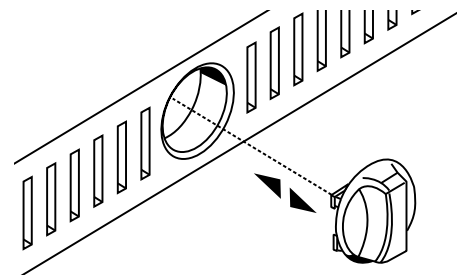

4. Rotate the cap to a horizontal position. The cap might not be even with the base grille.

Troubleshooting

Try the solutions suggested here first in order to avoid the cost of an unnecessary service call.

Refrigerator will not operate

⚠ WARNING



Electrical Shock Hazard

Plug into a grounded 3 prong outlet.
Do not remove ground prong.
Do not use an adapter.
Do not use an extension cord.
Failure to follow these instructions can result in death, fire, or electrical shock.

- Is the power supply cord unplugged? Plug into a grounded 3 prong outlet.
- Has a household fuse or circuit breaker tripped? Replace the fuse or reset the circuit breaker.
- Is the refrigerator or freezer control turned to the OFF position? See *Setting the Controls* on page 5.
- Is the refrigerator defrosting? Re-check to see if the refrigerator is operating in 30 minutes. Your refrigerator will regularly run an automatic defrost cycle.

Temperature is too warm

- Are the air vents blocked in either compartment? Blocked air vents obstruct cold air movement between the compartments. Remove any objects from in front of the air vents. See *Ensuring Proper Air Circulation* on page 5.
- Are the door(s) opened often? The refrigerator will warm when this occurs. Keep the refrigerator cool by getting all items out at one time, keeping food organized, and closing the door as soon as possible.
- Has a large amount of food just been added to the refrigerator or freezer? Adding a large amount of food warms the refrigerator. It can take several hours for the refrigerator to return to the normal temperature.
- Are the controls set correctly for the surrounding conditions? See *Setting the Controls* on page 5.
- Is the refrigerator not cooling? Turn the unit OFF then ON again to reset. See *Setting the Controls* on page 5. If the problem is not corrected, call for service.

The lights do not work

- Is a light bulb loose in the socket or burned out? See *Changing the Light Bulbs* on page 13.
- Has the door been open more than 10 minutes? When the door is held open for more than 10 minutes, the *Door Open* indicator light will flash and the interior lights will shut off. See *Door Open* on page 7.
- Is the refrigerator in Holiday mode? See *Holiday Mode* on page 7.

The refrigerator seems to make too much noise

- The sounds may be normal for your refrigerator. See *Normal Operating Sounds* on page 5.

The motor seems to run too much

- Is the room temperature hotter than normal? The motor will run longer under warm conditions. At normal room temperatures, expect your motor to run about 80% of the time. Under warmer conditions, it will run even more.
- Has a large amount of food just been added to the refrigerator? Adding a large amount of food warms the refrigerator. The motor normally will run longer to cool the refrigerator back down.
- Are the doors opened often? If so, the motor will run longer. Conserve energy by getting all items out at one time, keeping food organized, and closing the door as soon as possible.
- Are the controls not set correctly for the surrounding conditions? See *Setting the Controls* on page 5.
- Are the doors not closed completely? Close the doors firmly. If they do not close completely, see *The doors will not close completely* in this section.
- Are the condenser coils dirty? This obstructs air transfer and makes the motor work harder. Clean the condenser coils. Refer to the *Care and Cleaning* section.
- Are the door gaskets not sealed all the way around? Contact a technician or other qualified person.
- NOTE: Your new refrigerator will run longer than your old one due to its high-efficiency motor.

There is interior moisture buildup

- Are the air vents blocked in the refrigerator? Remove any objects from in front of the air vents. See *Ensuring Proper Air Circulation* on page 5.
- Are the door(s) opened often? Avoid humidity buildup by getting all items out at one time, keeping food organized, and closing the door as soon as possible.
- Is the room humid? It is normal for moisture to build up inside the refrigerator when the room air is humid.
- Is the food packaged correctly? Check that all food is securely wrapped. Wipe off damp food containers before placing in the refrigerator.
- Are the controls set correctly for the surrounding conditions? See *Setting the Controls* on page 5.
- Was a self-defrost cycle completed? It is normal for droplets to form after the refrigerator self-defrosts.

Off-taste, odor or gray color in the ice

- Are the plumbing connections new, causing discolored or off-flavored ice? Discard the first few batches of ice.
- Have the ice cubes been stored too long? Throw old ice away and make a new supply.
- Does the freezer and ice bin need to be cleaned? See the *Care and Cleaning* section or *Ice Maker and Storage Bin* on page 8.

Troubleshooting

- Has food in the freezer or refrigerator been wrapped properly? Use airtight, moisture-proof packaging to avoid odor transfer from stored food.
- Does the water contain minerals (such as sulfur)? A filter may need to be installed to remove the minerals.
- Is there a water filter installed on the refrigerator? Gray or dark discoloration in ice indicates that the water filtration system needs additional flushing. Run additional water through the water dispenser to flush the water filtration system more thoroughly (at least 6 qt. [5.7 L] or 3 to 4 minutes initially). Discard discolored ice.

The ice maker is not producing ice or not enough ice

- Has the ice maker just been installed? The ice bin holds 14 to 17 lbs (6.4 to 7.7 kg) of ice. The ice bin can take three to four days to completely fill, if no ice is used.
- Is the freezer temperature cold enough to produce ice? Wait 24 hours after ice maker hookup for ice production. See *Setting the Controls* on page 5.
- Is the ice maker wire shutoff arm in the off (arm up) position (on non-dispensing models)? Lower the wire shutoff arm to the on (arm down) position. See *Ice Maker and Storage Bin* in the operation section.
- Is the ice maker switch in the OFF (right) position (on dispensing models)? Move ice maker switch to the ON (left) position. See *Ice Maker and Storage Bin* in the operation section.
- Is the water line shutoff valve to the refrigerator turned on? Turn on the water valve. See *Connect Water Supply* in the installation instructions.
- Does the ice maker mold have water in it or has no ice been produced? Make sure your refrigerator has been connected to a water supply and the supply shutoff valve is turned on. See *Connect Water Supply* in the installation instructions.
- Is an ice cube jammed in the ice maker ejector arm? For models with an interior ice bin, remove the ice from the ejector arm with a plastic utensil. For models with an ice bin located on the freezer door, access the ice maker by depressing the ice sensor door on the upper left side of the freezer interior. While depressing the sensor door, lift the ice maker service door and remove the ice from the ejector with a plastic utensil. See *Ice Maker and Storage Bin* in the operation section.
- Has a large amount of ice just been removed? Allow three to four days for an empty ice bin to completely fill, if no ice is used.
- Are the controls set correctly? See *Setting the Controls* on page 5.
- Is there a water filter installed on the refrigerator? The filter may be clogged or installed incorrectly. Check the filter installation instructions to ensure that the filter was installed correctly and is not clogged. If installation or clogging is not a problem, call a qualified service technician.
- **NOTE:** If not due to any of the above, there may be a problem with the water line. Call for service.

The ice dispenser will not operate properly

- If the ice storage bin is located on the door, remove the temporary shield from underneath the ice storage bin. See *Ice Maker and Storage Bin* on page 8.
- Is the freezer door closed completely? Push the door firmly shut. If it will not shut all the way, see *The doors will not close completely* in this section.
- Is the ice bin installed correctly? For models with an interior ice bin, push the ice bin in all the way. If the ice bin does not go in all the way, it may not be put in straight. Pull it out and try again. For models with an ice bin located on the freezer door, the bin should sit level. To remove the bin, press the release button on the right side of the bin and lift straight up.
- Replace the bin in the door making sure it is properly aligned and snapped securely into place. See *Ice Maker and Storage Bin* on page 8.
- Has the wrong ice been added to the bin? Use only cubes produced by the current ice maker. If other cubes have been added, remove all cubes and check to see that none have become stuck in the delivery chute.
- Has the ice frozen in the ice bin? Shake the ice bin to separate cubes. If cubes do not separate, empty bin and wait 24 hours for ice to restock.
- Has the ice melted around the auger (metal spiral) in the ice bin? Dump the ice cubes and clean the ice bin completely. Allow 24 hours for the ice maker to restock. Do not try to remove the melted ice with a sharp object. You could damage the ice bin.
- Is ice stuck in the delivery chute? Clear the ice from the delivery chute with a plastic utensil. Do not use anything sharp to remove the ice. You could cause damage.

WARNING



Cut Hazard

Use a sturdy glass when dispensing ice.

Failure to do so can result in cuts.

- Is the ice dispenser stalling while dispensing “crushed” ice? Stop dispensing ice. Change the ice button from “crushed” to “cubed.” Depress the ice dispenser arm using a sturdy glass. If cubed ice dispenses correctly, depress the button for “crushed” ice and begin dispensing again. See *Water and Ice Dispensers* on page 8.
- Is there ice in the bin? See *The ice maker is not producing ice* earlier in this section.
- Has the dispenser arm been held in too long? Release dispenser arm. Ice will stop dispensing when the arm is held in too long. Wait three minutes for dispenser motor to reset before using again. It is best to take large amounts of ice directly from the ice bin, not through the dispenser.

Troubleshooting

The ice storage bin is difficult to remove

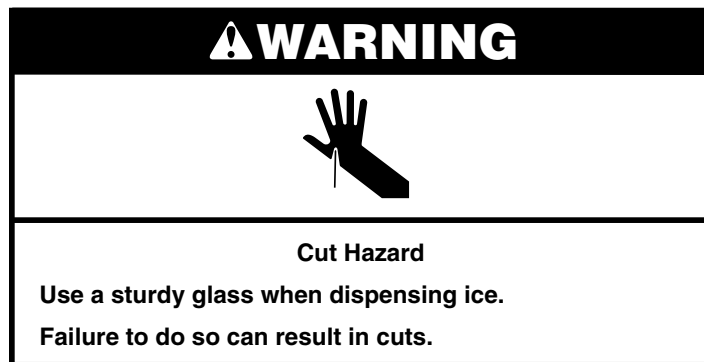

- Is the ice storage bin difficult to remove (on some models)? For models with an ice storage bin located on the freezer door, select “cubed” ice. Using a sturdy glass, quickly depress and release the ice dispenser lever. Open the freezer door, depress the release button on the ice storage bin and lift upward. See *Ice Maker and Storage Bin* on page 8.

The water dispenser will not operate properly

- Has the water system not filled? The water system needs to be filled the first time it is used. Use a sturdy container to depress the water dispenser bar until the water begins to flow. Flush the water system by dispensing and discarding 6 qt (5.7 L) of water. Cleaning the system will take approximately 3 to 4 minutes and will help clear air from the line. Additional flushing may be required in some households. See *Water and Ice Dispensers* on page 8.
- Is the water shutoff valve not turned on or the water line connected at the source? Make sure the water shutoff valve is turned on and the water source is connected to the refrigerator. See *Connect Water Supply* in the installation instructions.
- Is the water shutoff valve clogged or incorrectly installed? See *Connect Water Supply* in the installation instructions. If clogging or installation is not a problem, call for service or contact a plumber.
- Is there a kink in the home water source line? If you find or suspect a kink in the water line, call for service.
- Is there a water filter installed on the refrigerator? The filter may be clogged or incorrectly installed. First, check the filter installation instructions to ensure that the filter was installed correctly and is not clogged. If installation or clogging is not a problem, call for service.

The dispenser water is not cool enough

- Has the refrigerator been newly installed? Allow 24 hours for the refrigerator to cool completely.
- Has a large amount of water been recently dispensed? Allow 24 hours for the water to cool completely.
- Has water not been recently dispensed? The first glass of water may not be cool. Discard the first glass of water.
- The divider between the two compartments is warm. The warmth is probably due to normal operation of the automatic exterior moisture control. If still concerned, call for service.

Water is leaking from the dispenser

- Glass not being held under the dispenser long enough? Hold the glass under the dispenser 2 to 3 seconds after releasing the dispenser lever.
- Is there a water filter installed on the refrigerator? The water filtration system may have air in the lines, causing water to drip. Additional flushing may help clear air from the lines. Normal dispenser use should flush air from the lines within 24 to 72 hours.

Water flow from the dispenser decreases noticeably

- Is there a water filter installed on the refrigerator? The filter may be full or incorrectly installed. Remove the water filter cartridge. See *Replacing the Water Filter* on page 14. Operate the dispenser. If the water flow increases noticeably, replace the filter.

The doors will not close completely

- Are food packages blocking the door open? Rearrange containers so that they fit more tightly and take up less space.
- Is the ice bin out of position? For models with an interior ice bin, push the ice bin in all the way. If the ice bin does not go in all the way, it may not be put in straight. Pull it out and try again. For models with an ice bin located on the freezer door, the bin should sit level. To remove the bin, press the release button on the right side of the bin and lift straight up. Replace the bin in the door making sure it is properly aligned and snapped securely into place. See *Ice Maker and Storage Bin* on page 8.
- Are the pans, shelves, bins, or baskets out of position? Put the crisper cover and all pans, shelves, bins, and baskets back into their correct positions. See *Crisper and Covers* on page 10.
- Does the refrigerator wobble or seem unstable? Level the refrigerator. See *Adjust Doors and Level Refrigerator* in the installation instructions.

The doors are difficult to open

- Are the gaskets dirty or sticky? Clean gaskets according to the directions in the *Care and Cleaning* section.

Product Data Sheets

Base Grille Water Filtration System (Water Filter)

Model WF-LC400V/LC400V Capacity 400 Gallons (1514 Liters)



Tested and certified by NSF International against ANSI/NSF Standard 42 for the reduction of Chlorine Taste and Odor, Particulate Class I*; and against ANSI/NSF Standard 53 for the reduction of Lead, Mercury, Atrazine, Benzene, Toxaphene, p-dichlorobenzene, 2, 4-D, Cysts, Turbidity and Asbestos.

This system has been tested according to ANSI/NSF 42/53 for the reduction of the substances listed below. The concentration of the indicated substances in water entering the system was reduced to a concentration less than or equal to the permissible limit for water leaving the system, as specified in ANSI/NSF 42/53.

Substance Reduction	NSF Reduction Requirements	Average Influent	Influent Challenge Concentration	Maximum Effluent	Average Effluent	Minimum % Reduction	Average % Reduction
Chlorine Taste/Odor Particulate Class 1*	≥50% ≥85%	2.1 mg/L 5,366,667/mL	2.0 mg/L ± 10% At least 10,000 particles/mL	0.06 mg/L 4,100/mL**	0.05 mg/L 2,300/mL	97.1% 99.3%	97.6% 99.9%

Contaminant Reduction	NSF Reduction Requirements	Average Influent	Influent Challenge Concentration	Maximum Effluent	Average Effluent	Minimum % Reduction	Average % Reduction
Lead: @ pH 6.5 Lead: @ pH 8.5	0.01mg/L 0.01mg/L	0.152 mg/L† 0.143 mg/L†	0.15 mg/L ± 10% 0.15 mg/L ± 10%	0.001 mg/L 0.001 mg/L	0.001 mg/L 0.001 mg/L	99.34% 99.30%	99.34% 99.30%
Mercury: @ pH 6.5 Mercury: @ pH 8.5	0.002 mg/L 0.002 mg/L	0.0061 mg/L 0.0057 mg/L	0.006 mg/L ± 10% 0.0058 mg/L ± 10%	0.0004 mg/L 0.0008 mg/L	0.0003 mg/L 0.00051 mg/L	93.5% 85.8%	96.7% 91.2%
Benzene	0.005 mg/L	0.0162 mg/L	0.015 ± 10%	0.0005 mg/L	0.001 mg/L	96.3%	96.3%
p-dichlorobenzene	0.075 mg/L	0.220 mg/L	0.225 ± 10%	0.0005 mg/L	0.0005 mg/L	99.7%	99.7%
Toxaphene	0.003 mg/L	0.014 mg/L	0.015 ± 10%	0.0014 mg/L	0.001 mg/L	90%	92.96%
Atrazine	0.003 mg/L	0.0086 mg/L	0.009 mg/L ± 10%	0.0005 mg/L	0.0005 mg/L	94.25%	94.25%
2, 4-D	0.07 mg/L	0.197 mg/L	0.210 ± 10%	0.058 mg/L	0.0137 mg/L	70.6%	93.06%
Asbestos	99%	26 x 107	107 to 108 fibers/L††	0.18 x 107 mg/L	0.18 x 107 mg/L	99.93%	99.93%
Cysts‡ Turbidity	99.95% 0.5 NTU	111,000/mL 11.00 NTU	50,000/L min. 11 ± 1 NTU	1 mg/L 0.40 NTU	1 mg/L 0.35 NTU	99.99% 96.4%	99.99% 96.8%

Test Parameters: pH = 7.5 ± 0.5 unless otherwise noted. Flow = 0.5 gpm (1.9 Lpm). Pressure = 60 psig (413.7 kPa). Temp. = 63°F (17.2°C).

- It is essential that operational, maintenance, and filter replacement requirements be carried out for the product to perform as advertised.
- **Model WF-LC400V** The filter monitor system measures the amount of water that passes through the filter and alerts you to replace the filter. When 90% of the filter's rated life is used, the filter indicator light changes from green to yellow. When 100% of the filter's rated life is used, the filter indicator light changes from yellow to red, and it is recommended that you replace the filter.
- The product is for cold water use only.
- Do not use with water that is microbiologically unsafe or of unknown quality without adequate disinfection before or after the system. Systems certified for cyst reduction may be used on disinfected waters that may contain filterable cysts.

Application Guidelines/Water Supply Parameters

Water Supply	City or Well
Water Pressure	30 - 120 psi (207 - 827 kPa)
Water Temperature	33° - 100°F (0.6° - 37.8°C)
Service Flow Rate	0.5 GPM (1.89 L/min.) @ 60 psi.

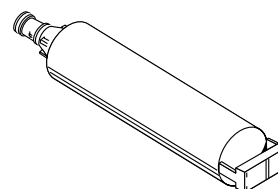

* Class I particle size: >0.5 to <1 um

** Test requirement is at least 100,000 particles/mL of AC Fine Test Dust.

† These contaminants are not necessarily in your water supply. Performance may vary based on local water conditions.

†† Fibers greater than 10 um in length

‡ Based on the use of *Cryptosporidium parvum* oocysts

© NSF is a registered trademark of NSF International.

Warranty and Service

Product Maintenance

Do not perform any maintenance other than that instructed in the **Care and Cleaning** section of this manual. A qualified service technician should perform all other service.

Getting Help

Before you obtain service, please review the **Troubleshooting** section of this manual. If you have performed the checks in the **Troubleshooting** section and the problem has not yet been remedied, please visit our web site or contact the Dacor Customer Service Team for a listing of Dacor authorized service agents. Before requesting service, become familiar with the warranty terms and conditions on this page.

Contact us through our web site at:

www.Dacor.com

Dacor Customer Service Team:

Tel: (800) 793-0093

Fax: (626) 403-3130

Business Hours: 6:00 a.m. - 5:00 p.m. Pacific Time

You may also write us at:

Dacor Customer Service Team
1440 Bridge Gate Drive
Diamond Bar, CA 91765

At Dacor, we believe that our quality of service equals that of our product. Should your experience with our service network or product be different, please contact our Customer Service Team and share your encounter with us. We will do our utmost to resolve the situation for you and deliver on our Dacor promise. If you need anything clarified, just let us know.

What is Covered

CERTIFICATE OF WARRANTIES DACOR REFRIGERATORS

WITHIN THE FIFTY STATES OF THE U.S.A., THE DISTRICT OF COLUMBIA AND CANADA*:

TWO YEAR LIMITED WARRANTY

For two years from the date of purchase, when this major appliance is operated and maintained according to instructions attached to or furnished with the product, Dacor will pay for factory specified parts and repair labor to correct defects in materials or workmanship. Service must be provided by a Dacor designated service company.

LIMITED WARRANTY

Major Refrigeration Components

In the third through sixth years from the date of purchase, when this major appliance is operated and maintained according to instructions attached to or furnished with the product, Dacor will pay for factory specified parts and repair labor costs to correct defects in materials or workmanship in the sealed refrigeration system. These parts are: compressor, evaporator, condenser, dryer, and connecting tubing. Service must be provided by a Dacor designated service company.

In the seventh through twelfth years from date of purchase, when this major appliance is operated and maintained according to instructions attached to or furnished with the product, Dacor will pay for factory specified parts to correct defects in materials or workmanship in the sealed refrigeration system. These parts are: compressor, evaporator, condenser, dryer, and connecting tubing.

LIMITED WARRANTY

Water Filter, if equipped

30 day limited warranty on water filter. For 30 days from the date of purchase, when this filter is operated and maintained according to instructions attached to or furnished with the product, Dacor will pay for replacement parts to correct defects in materials and workmanship.

NOTE

The full warranty and the limited warranties apply when the refrigerator is located in the United States or Canada. Refrigerators located elsewhere are covered by the limited warranties only including parts that fail during the first year.

CANADIAN RESIDENTS

The above warranties only cover an appliance installed in Canada that has been certified or listed by appropriate test agencies for compliance to a National Standard of Canada unless the appliance was brought into Canada due to transfer of residence from the United States to Canada.

LIMITATIONS OF LIABILITY

The warrantor shall not be liable for any incidental or consequential damages, including food loss. Some states do not allow the exclusion or limitation of consequential damages, so the above limitation or exclusion may not apply to you.

What is Not Covered

- Conditions and damages resulting from any of the following:
 - Improper installation, delivery, or maintenance.
 - Any repair, modification, alteration, or adjustment not authorized by the manufacturer or an authorized servicer.
 - Misuse, abuse, accidents, or unreasonable use.
 - Incorrect electric current, voltage, or supply.
 - Improper setting of any control.
- Warranties are void if the original serial numbers have been removed, altered or cannot be readily determined.
- Light bulbs.
- Products purchased for commercial or industrial use.
- The cost of service or service call to:
 - Correct installation errors.
 - Instruct the user on the proper use of the product.
 - Transport the appliance to the servicer.
- Consequential or incidental damages sustained by any person as a result of any breach of these warranties. Some states do not allow the exclusion or limitation of consequential or incidental damages, so the above exclusion may not apply.

Notes

