



Key Contacts

Service

UK: 08709 066 066

Republic of Ireland: 1850 302 200

You will be asked to quote the Model Number and Serial Number, which can be found on the underside of front top of appliance.

Genuine Parts & Accessories

Mail Order Hotline

UK: 08709 077 077

Republic of Ireland: (01) 842 6836

Extended Warranty

To join: UK 08709 088 088

Republic of Ireland: 1850 502 200

 For more information on our exciting product range ring
Creda Answer Centre 0541 54 64 74



General Domestic Appliances Limited
Morley Way, Peterborough, PE2 9JB.
Web: <http://www.creda.co.uk>

Easy Store Fridge Freezer Instruction Book

86410, 86411

& 86412



**It is essential that you read through this instruction book carefully
before you first use your appliance.**

Your new Appliance

For your own safety and to get the best results it is important that you read right through this handbook **before** using your appliance for the first time.

WARNING: THIS APPLIANCE MUST BE EARTHED.

Electrical Requirements

We recommend that this appliance is connected to the mains supply via a suitable switched socket in a readily accessible position.

All appliances come complete with a fitted plug containing a 13 amp fuse. In the event of replacing the fuse, a 13A ASTA approved fuse to BS1362 must be fitted. The fuse cover must be refitted. In the event of losing the fuse cover the plug must **not** be used until a replacement fuse cover has been obtained and fitted. A new fuse cover can be obtained from your nearest Service Office or local Electricity Company. If the plug does not fit your sockets, an alternative plug can be fitted. Cut off the old plug and throw it away. Do not insert it into a socket elsewhere in the house as this could cause a shock hazard.

IMPORTANT: Fitting a Different Plug:

The wires in the mains lead are coloured in accordance with the following code:

- Green and Yellow – Earth
- Blue – Neutral
- Brown – Live

If you fit your own plug the colours of these wires may not correspond with the identifying marks on the plug terminals. This is what you have to do:

1. Connect the green and yellow (Earth) wire to the terminal in the plug marked 'E' or with the symbol \perp , or coloured green or green and yellow.
 2. Connect the blue (Neutral) wire to the terminal in the plug marked 'N' or coloured black.
 3. Connect the brown (Live) wire to the terminal marked 'L' or coloured red.
- With alternative plugs a 5A fuse must be fitted either in the plug or adaptor or in the main fuse box.

Mains Lead Replacement

If the mains lead on this appliance needs replacing at any time, it must be replaced by a special lead which is obtainable from your nearest Service Office (see back page). A charge will be made for the replacement if you have damaged the lead or require a longer lead. It is essential that this operation is carried out by a qualified Electrician.

The old mains lead should be disposed of safely and **not** used for any other application.

NOTE: CE marking certifies that this appliance complies with the requirements laid down in EEC Directive 89:336 (Electromagnetic compatibility) and subsequent modifications and Low Voltage directive 73/23/EEC.

WARNING: HOW TO AVOID ACCIDENTS TO CHILDREN, WHEN DISCARDING AN OLD FRIDGE OR FREEZER BE CERTAIN TO MAKE THE LOCK UNUSABLE. IF POSSIBLE, REMOVE THE DOOR AND DISCARD SEPARATELY. DO NOT ATTEMPT TO STAND OR SIT ON TOP OF YOUR APPLIANCE. IT IS NOT DESIGNED FOR SUCH USE AND YOU COULD INJURE YOURSELF OR DAMAGE THE APPLIANCE BY SUCH ABUSE. CHILDREN SHOULD NOT BE ALLOWED TO PLAY WITH THE APPLIANCE OR TAMPER WITH THE CONTROLS.

Creda Service Cover

THANK YOU FOR CHOOSING CREDA...

We appreciate you choosing this quality appliance from Creda and are sure that it will give you many years of excellent service.

Now that you've chosen Creda, not only have you bought a first class appliance, you've also bought a commitment from us to look after your appliance. We believe from our Creda Care Service is the best in the business and yet another good reason you'll be glad you chose Creda.

Every Creda appliance has been designed and manufactured to the highest standards. However, in the event of any problem developing, our trained professional engineers are just a phone call away with one real objective - to satisfy you by providing an efficient, effective and courteous service, at a time convenient to you.

CREDA - your GUARANTEE . . .

The guarantee is subject to the provision(s) that the appliance:

- a) Has been used solely in accordance with the instruction book.
 - b) Has been properly connected to a suitable electricity supply voltage as stated on the rating plate attached to the equipment.
 - c) Has not been subjected to misuse or accident or an authorised employee or agent of Creda.
 - d) Has been correctly installed.
 - e) Has been used solely for domestic purposes and is applicable in the U.K. and the Republic of Ireland.
- If you suspect a fault with your appliance, to avoid unnecessary inconvenience and expense please ensure that the checks detailed on page 16, 'If Your Fridge Freezer won't work' have been carried out before contacting the SERVICE NETWORK.
- Should you require service our receptionist will require the following information:
- * Your post code, name and address, type of appliance, model number, (found on the appliance rating plate or in the handbook), Guarantee/Contract/Insurance Policy Details, Date of Purchase, and where you purchased it from.
- EASY PAYMENT METHODS...**
- You can pay for any of our services offered either by Credit Card (Visa, MasterCard), Cheque and Debit Card, Or in installments by Direct Debit provided you include a Creda Care Plus scheme.

CREDA CARE - HIGH QUALITY AFTER-SALES SERVICE LEVELS

- * **IN GUARANTEE (Year 1)**
All appliances carry a FREE fully inclusive 12 months parts and labour guarantee. If service under your Year 1 Guarantee is required please have available evidence of your date of purchase when the engineer calls.

- * **OUT OF GUARANTEE (Years 2-10)**
Once an appliance is over 12 months old, and goes out of guarantee, Creda offer you a very simple choice of service levels:

CREDA CARE LEVEL 1: No advance fee payable, no registration necessary.

Should a repair be needed in years 2-10, (i.e. over 12 months old) your Creda Regional Service Centre will advise you of the fixed labour charge we will make.

Although this charge will vary according to your location and the type of Creda appliance you own, it is fixed regardless of the time taken or the number of visits required to complete the repair.

The cost of parts where required will be charged additional to the fixed labour charge, but again this cost will have a maximum level of which you will be advised

by your Regional Service Centre. The repair itself is fully guaranteed for 12 months.

CREDA CARE LEVEL 2: Annual fee payable all inclusive cover provided.

You may prefer the peace of mind of an all-inclusive type of cover, this is provided by our Creda Care Plus Scheme which, for an annual fee covers the cost of any parts or labour. This applies on appliances up to 10 years old. To join simply call UK: 08709 088 088 or Republic of Ireland: 1850 502 200.

For your convenience this fee can be paid in installments by Direct Debit. Payments can also be made by Credit Card (Visa, MasterCard), Cheque and Debit Card.

CREDA CARE LEVEL 3: Creda Kitchen Cover

For an extra fee, you can also purchase Kitchen Cover for all your Creda appliances provided they are under 10 years old. To join simply call UK: 08709 088 088 or Republic of Ireland: 1850 502 200 and register.

CREDA EASY ACCESS REPAIR SERVICE

One number - 08709 066 066 connects you automatically to your U.K. Regional Service Centre to arrange for your local engineers to call. Office opens 7 days a week, 364 days a year. Monday - Friday 8am - 8pm, Saturday 8am - 6pm, Sunday 10am - 6pm. For the Republic of Ireland call 1850 302 200, Monday - Friday 8am - 5.30pm, Saturday 9.00am - 12.30pm. This is the largest appliance manufacturer service team in Europe. Trained specialists covering all our appliances (and directly employed by us). If contacted before 10am, we try to offer a service call the same day where required or the next working day, (Monday to Friday). On request, your service call can be the first or last of the day with am or pm timings always available. We can also cater to meet your specific needs ie, avoiding school hours whenever we can.

A chargeable service is offered on the basis of payment on completion to our service engineer, who will issue a receipt. Creda Service Engineers drive recognisable vans, wear uniforms and carry identity cards. Creda Service Engineers will only fit genuine Creda parts.

CREDA ANSWER CENTRE

Information and advice regarding specific appliance features and pricing on any Creda appliance, before or after purchase. From anywhere in the U.K., telephone 0541 64 64 74 and 8.45am - 5.30pm, Monday - Friday.

CREDA PARTS AND ACCESSORIES NATIONAL MAIL ORDER HOTLINE

The Spare Parts Mail Order Hotline enables you to order parts directly from the manufacturer over the phone. A wide range of parts and accessories are available for your Creda appliance.

Telephone: 08709 077 077 Fax: 08709 076 076
Republic of Ireland Parts Telephone: 01 842 6636
Monday - Friday 8.30am - 5.30pm, Saturday 8.30am - 12 noon.

Ring quoting your appliance model number and we will help you get the right parts. National Warehouse comprehensively stocked over 33,000 parts lines. Parts stocked for all models. Parts carried for all appliances up to 10 years old. (15 on Creda Heating appliances). Optional 24 hour express courier service. (Additional charge).

CARE FOR THE DISABLED

We offer a range of accessories which enable our blind arthritic or disabled customers to use most of our appliances. Simply call 08709 077 077 and provide the model number details.

All the above are offered as an extra benefit and do not affect your statutory rights.

Changing the door opening side (cont.)

19. Replace the adjustable front feet, setting them 36mm from the bottom of the cabinet to the bottom of the foot.
 20. Carefully stand your fridge freezer upright (you may need assistance for this) in the required location. Adjust the front feet until all four feet are in firm contact with the floor and the appliance does not rock.
(See Installing Your Fridge Freezer).
 21. Check the door opens and closes freely. Ensure door seal is seated evenly around the cabinet.
 22. Finally put back all the loose items/fittings.
 23. The fridge freezer must be stood upright for at least 15 minutes before being switched on.
- NOTE:** If difficulties are encountered, contact your local Service Office. There may be a charge should it be necessary for a service engineer to visit.

Contents

THIS BOOK COVERS MODEL 86410, 86411 & 86412

| | Page |
|---|--------------|
| Get to know your Appliance | 4 |
| Installing your Fridge Freezer | 5-6 |
| Where to put your fridge freezer Fitting decor panels to match your kitchen units | |
| Getting your Fridge Freezer ready for use | 7 |
| Starting and Running In | |
| The Controls | 8 |
| Controlling the temperature | |
| Storing Food | 9-12 |
| Storing food in the fridge compartment Storing already frozen food in the freezer compartment Freezing fresh foods – maximum freezing loads and how to freeze them Do's and Don'ts | |
| Caring for your Fridge Freezer | 13-15 |
| Defrosting Cleaning Going away Replacing the interior light Spare Parts | |
| If your Fridge Freezer won't work | 16-19 |
| Repositioning the door hinges Creda Guarantee | |
| For details of spares, service and guarantee see separate service leaflet. | |

Retention of the Instruction Book

This Instruction Book must be kept handy for reference as it contains important details on the safe and proper use of the appliance.

If you sell or pass the appliance to someone else, or move house and leave it behind, make sure this Book is also provided so the new owner can become familiar with the appliance and safety warnings.

Get to know your Fridge Freezer

Thermostat Control Dial
Model 86412

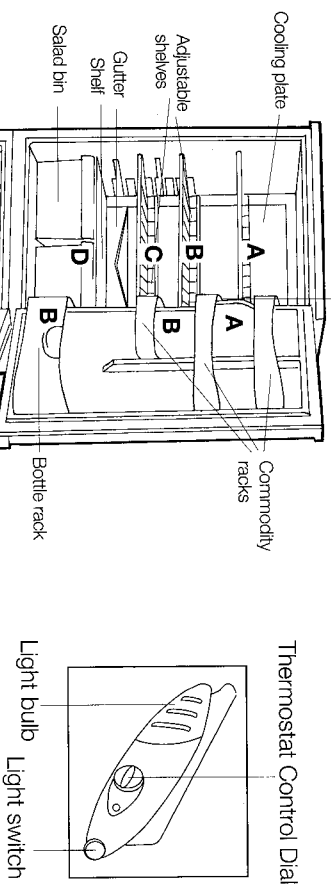

Model 86411

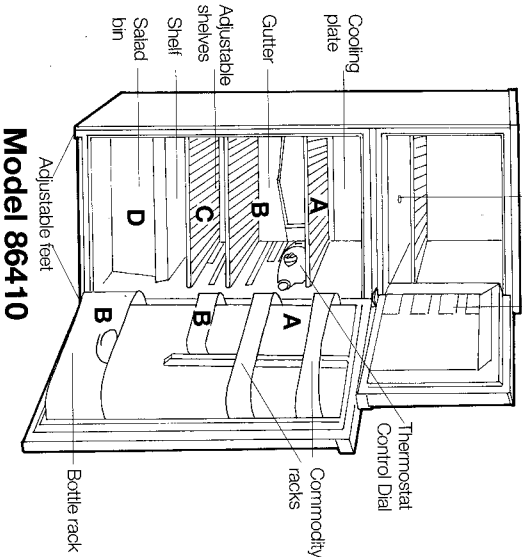
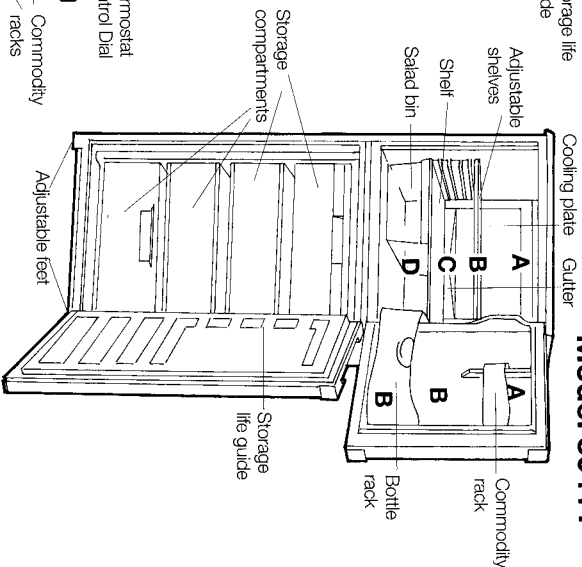

Listed below are the features within the model. The interior of the model is divided into zones:
A and **D** = Cool zone;
B = Colder zone and
C = Coldest zone.
 The Storing Food recommendations on page 9 should be followed in conjunction with the zone areas as indicated.

Changing the door opening side

Repositioning the door hinge

Just follow the step by step instructions below:

1. Remove all loose items/fittings from inside the fridge freezer.
2. Carefully lay the fridge freezer on its back (you may need a second person to support the appliance). **Take care to avoid damage to the pipework by keeping it clear of the floor or by laying it on some protective material (eg. its original packaging).**
3. Unscrew and remove the two front feet.
4. Unscrew and remove the bottom hinge. Ensure any spacing washers fitted and the fixing screws are kept with the hinge.
5. Remove the door by gently pulling it downwards. Stand the door carefully to one side.
6. Unscrew and remove centre hinge.
7. Remove the top door by gently pulling it downwards. Stand the door carefully to one side.
8. Unscrew and remove the top hinge. Replace the screws.
9. Prise off the screw covers on the centre left hand side (using a thin blunt instrument). Remove the screws and cup washers and refit on the right hand side.
10. Remove the hinge fixing screws on the top left hand side of the cabinet and refit top hinge.
11. Remove the screws from the front/bottom left hand side of the cabinet and refit on the right hand side, where the bottom hinge was.
12. **Prepare the doors for change over.**

care not to mark the handle. Reposition on the opposite side.

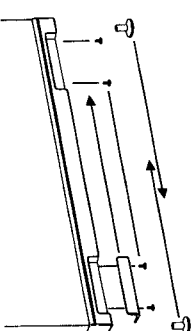

- b To reposition handle insert, place the bowl section of a spoon beneath the corner edge of insert, as shown below, and push handle end of spoon gently downwards to release edge. Lift insert and replace on opposite side of door.

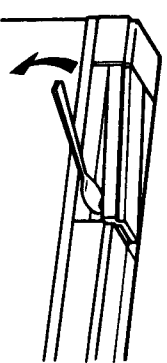

13. Refit the door, sliding it upwards, locating the top hinge pin in the door hinge bush.
 14. Fit the centre hinge (and spacing washers) into the bottom hinge bush of the top door, positioning the door so that it fits evenly with the cabinet sides.
 15. Using the two fixing screws secure the centre hinge to the support bracket.
 16. Refit the bottom door, sliding it upwards, locating the centre hinge in the door hinge bush.
 17. Fit the bottom hinge (and spacing washers) into the bottom hinge bush, ensuring the door is evenly positioned about the cabinet sides.
 18. Using the two fixing screws secure the bottom hinge to the cabinet.
- a Remove the top and bottom hinge bushes and blanking plug with a thin blunt instrument taking

CHILDREN SHOULD NOT BE ALLOWED TO PLAY WITH THE APPLIANCE OR TAMPER WITH THE CONTROLS

If your Fridge Freezer won't work

... don't panic

Just run through these quick checks before calling your nearest Creda Service Office.

1. Check that the plug is firmly in the wall socket and that the power supply is on.
 2. Check the power supply to the socket by plugging in another appliance.
 3. If the other appliance works, check the fuse in the appliances plug.
 4. If you have changed the plug, check the wiring (see page 2).
 5. If there is excessive noise or vibration, check that all four feet are firmly in contact with the ground (see page 5).
 6. If the interior light fails to work, refer to page 15 for further instructions.
 7. If water appears down the inside back of the fridge compartment, check that the gutter drain hole has not become blocked and that there is nothing touching the cooling plate. (NB Water droplets on the cooling plate are quite normal.)
 8. You may find the freezer compartment door difficult to open just after you have used it. This is due to a pressure difference which will soon equalise. Wait a few minutes then open the door.
- If, after following all these instructions, you are still having problems, contact your nearest Creda Service Office (or local importer if outside the United Kingdom). The telephone number is shown in the service leaflet.



0541 500 500
in the UK

**For Eire, Channel Isles,
Isle of Man, Shetland,
Orkney and Western Isles
(see back cover)**

When you contact us we will need to know the following information:

Name:

Address:

Post Code:

Tel No:

Fault Details:

Model No:

Serial No:

(See label on underside of front top of the appliance)

Place of Purchase:

Date of Purchase:

Details:

Guarantee/Contract/Insurance Policy

Make sure you have all these details before you call.

Installing your Fridge Freezer

Where to put your fridge freezer.

Your fridge freezer should be placed where it is easy to use, alongside a work surface is often a good position. You must leave a gap of 25mm on each side of the appliance.

Do not put your fridge freezer in a very cold room where the temperature goes below 6°C (43°F) for prolonged periods. In such a position the freezer compartment will run warmer and the storage time of frozen food may be reduced.

Avoid putting it near anything which gives off heat, a cooker or radiator for example or in a position where direct sunlight is liable to shine directly onto the appliance. In such a position your appliance will have to work harder and will cost more to run and may be damaged by the heat.

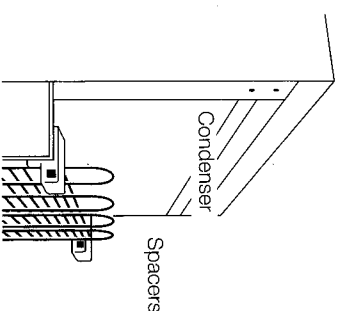

Once you have decided on the most suitable place, fit the two wall spacers supplied to the top of the condenser as shown and push the freezer back until the spacers are against the wall. This automatically ensures adequate air circulation at the back of the fridge freezer.

If your fridge freezer is placed underneath any wall cupboards, make sure that there is a gap of at least 100mm (4in) between the top of the fridge freezer and the underside of the

cupboards. Finally, make sure that your appliance is standing correctly by carefully screwing the left hand foot until all four feet are in firm contact with the floor. The right hand foot has been factory set to the correct position but in extreme conditions may require some adjustment. Correct adjustment avoids excessive vibration and noise. Do not obstruct the gap underneath the appliance.



Fitting decor panels to match your kitchen units

For that fully co-ordinated kitchen look it is possible to fit matching decor panels to your fridge freezer. Special trim kits are available that attach to the edges of the appliance doors and enable decor panels, up to 4mm (1/8in) thick, to be fitted. Decor panels are available from most kitchen suppliers. Each door requires a separate trim kit. You will require 2 (two):

These are available from your retailer, nearest Creda Spares Stockist or Creda direct using the Accessories Order Form supplied with your Fridge Freezer.

Commodity rack adjustment, see Fig 1

The commodity rack enables you to make maximum use of the storage capacity of the inner door. Depending on the model, some doors have adjustable rack positions. To remove the rack for cleaning or repositioning, simply lift vertically to release it from the fixing supports (A) in the door liner. To replace, align the grooves (B) on the side of the rack above the fixing supports (A), push down until it clicks into place.

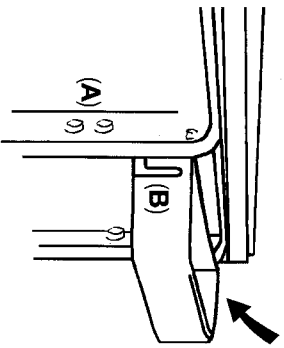

Fig 1

Adjustable/Tilting shelves, see Fig 2

The shelving system in the fridge interior has also been designed to provide maximum storage flexibility. It is possible to position the shelves at various heights to suit the items being stored and it is also possible to tilt certain shelves thereby allowing safe storage of bottles and jars on their sides.

To tilt a shelf place the shelf hanger (A) at the back of the shelf on a lower level than the main body of the shelf (B) (see diagram below).

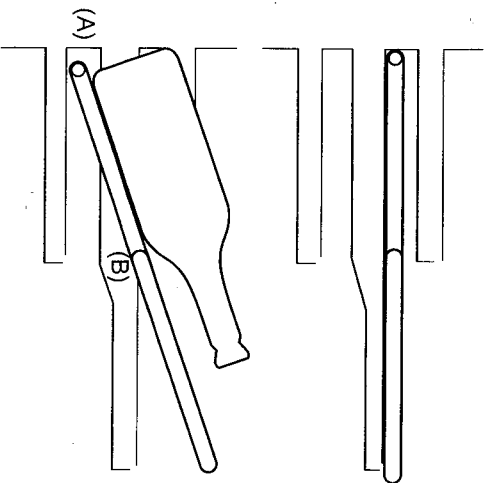

Fig 2

Replacing the interior light

Should the light fail to work, do not worry, it will not affect the working of your fridge freezer. Obtain a replacement SES 15 Watt bulb from a local electrical retailer, your nearest Creda Spares Stockist or Creda direct. Fit the replacement as follows:

1. Switch off and pull out the mains plug.
2. Remove the wire shelves to make access easier.
3. To remove the lamp guard, lightly squeeze the sides and pull to the left.
4. Unscrew the old bulb and fit the new one.
5. Refit the lamp guard.
6. Replace the plug and switch on.

Spare Parts

Please remember your new appliance is a complex piece of equipment.

'DIY' repairs or unqualified and untrained service people may put you in danger, could damage the appliance and might mean you lose cover under Creda's Parts Guarantee.

If you do experience a problem with the appliance don't take risks; call in Creda's own Service Engineer.

Our spare parts are designed exclusively to fit only Creda appliances. Do not use them for any other purpose as you may create a safety hazard.

Caring for your Appliance (cont.)

6. Sponge out the defrost water which collects in the bottom of the freezer.
7. After defrosting remove the bowls and dry the interior thoroughly before replacing the baskets.
8. Replace the mains plug and switch on. Unwrap the frozen food and replace. Close the door.

Cleaning your fridge freezer

It is a good idea to clean the inside of the fridge freezer after defrosting. **Always switch off and pull out the mains plug first.** Wipe out the inside of the fridge freezer using a clean cloth wrung out in either a solution of one teaspoonful of bicarbonate of soda to one pint of water or Milton dilute according to manufacturers' instructions. The complete interior including the door, and removable parts should be washed. The commodity and bottle racks may be washed in a dishwasher, but only if positioned in the top rack and on a low temperature programme. Never use any household cleaner or detergent, abrasive powders or wax polish. These not only damage the surfaces, but also leave a smell in the fridge freezer. Make sure that no particles of food are left in the gutter in the fridge compartment. Before you refill the fridge freezer ensure that it is thoroughly dry.

Cleaning the exterior of your Fridge Freezer

Clean the outside of the appliance, **but not the door seal**, with a damp cloth, using a small amount of detergent, followed by a wipe down with a clean cloth. **DO NOT** use an abrasive powder.

The rubber door seal must be

cleaned with soap and water only as detergent will damage it.

Finally, the compressor and condenser, at the back of the appliance, should be carefully cleaned. Use a brush or vacuum cleaner to remove any dust. Always check that the fridge freezer is disconnected from the mains when doing this. Remember to replace the mains plug and switch on after cleaning your appliance.

Going away

If you expect to be away for any length of time and don't want to use the fridge part of your appliance, but wish to continue using the freezer compartment. Remove all food from the fridge and wipe out the interior, remembering to close the fridge door so that the freezer compartment maintains the correct temperature. If you do not wish to use the freezer compartment as well, switch off the socket outlet and pull out the plug. Remove **all** frozen food and follow the defrosting instructions (see page 13). After defrosting, dry out the interior. **Always** leave both doors ajar to prevent the accumulation of odours.

Getting your Fridge Freezer ready for use

Before using your fridge freezer for the first time the interior, including the door and all removable parts should be wiped out. Use a damp cloth wrung out in either a solution of one teaspoonful of bicarbonate of soda to one pint of water or Milton® diluted according to the manufacturer's instructions.

WARNING: NEVER USE ANY HOUSEHOLD CLEANER OR DETERGENT, ABRASIVE POWDERS OR WAX POLISH. THESE NOT ONLY DAMAGE THE SURFACES, THEY ALSO LEAVE A SMELL IN THE FRIDGE.

Final check

Before you start using your appliance, check that:-

1. It is thoroughly dry inside,
2. Air can circulate freely,
3. The feet have been adjusted, ie. all four are firmly on the ground.

Starting

Insert the plug into the socket outlet and switch on the electricity supply. Open the fridge compartment door and the interior light will come on. There is a control dial on the right hand side of the interior. Turning the dial clockwise from 'O' (OFF) will start the appliance working. You will hear a noise as the compressor starts up.

If you are going to store food already frozen, allow at least two hours before you put in the frozen food.

Running-in the compressor

The liquid and gases sealed within the refrigeration system may give rise to noise, whether the compressor is running or not. This is quite normal. Your appliance is operated by a compressor which switches on and off in order to maintain the temperatures. The compressor is a precision piece of machinery and like a car engine, requires a running-in period of up to two months. During this time the compressor has to work a little harder and this may result in more noise than usual.

NOTE: Your fridge freezer is designed only for domestic purposes; for the storage of fresh and frozen food.

The Controls

Controlling the temperature inside the fridge compartment

The temperature inside your refrigerator should be 5°C or less, though some sections such as the Salad Bin will be warmer. Frequent door openings cause higher temperatures inside.

If using a thermometer to check the temperature, it should be left overnight on the centre of the middle shelf preferably in a position where it can be viewed without moving it and read immediately the door is initially opened the following morning. If the temperature reading is not between 0°C and 5°C then the controls should be adjusted.

WARNING: DO NOT USE A MERCURY FILLED THERMOMETER AS BREAKAGE COULD CAUSE A HEALTH HAZARD.

The control dial, on the right-hand side of the fridge compartment interior, controls the temperature inside the fridge and freezer compartments and is marked 'O' (OFF), 1, 2, 3 . . . 6.

The setting selected depends on the position of the appliance, how often you open the door and the room temperature. A control setting of '3-4' is usually suitable, but if you find the interior is too warm turn the control clockwise to a colder setting (higher number). Similarly, if you find the interior is too cold, turn the control anti-clockwise to a warmer setting (lower number).

Controlling the temperature inside the freezer compartment

With a suitable fridge compartment temperature the freezer compartment will automatically be maintained at the correct temperature necessary for ******* frozen food storage (see storing frozen food in your freezer compartment (page 10).

In the summer months, or in conditions giving high temperatures around the fridge freezer, the compressor has to work harder and run for longer periods. This is quite normal. Conversely, during cold weather the compressor will run for much shorter periods.

Caring for your Appliance

Defrosting

The fridge compartment

The fridge compartment will **automatically** defrost itself and the defrost water will drain out through the hole in the gutter and into a special container where it evaporates. Water droplets will form on the cooling plate during the defrost periods and will freeze on the plate afterwards. If your kitchen becomes exceptionally warm the cooling plate may not defrost regularly. Do not worry. Periodic defrosting will begin again when conditions return to normal. **DO** make sure that the gutter is always kept clear and that stored food does not come into contact with the cooling plate.

The freezer compartment

Frost forms on the cold surfaces from the moisture in the air and improperly wrapped food. The frost will build up first on the roof of the Fast Freeze compartment, towards the front, this is normal.

From time to time remove the frost from this, and other frosted surfaces, using the plastic scraper provided.

Never use sharp metal tools to remove the frost - they could damage your freezer beyond repair.

Periodically you will need to fully defrost your freezer, how often will be dependant on usage. Try to defrost when there is little or no food in the freezer compartment.

Defrosting must be carried out as quickly as possible since a rise in the temperature in the frozen food may reduce the recommended storage time. Just follow steps 1 to 8:

1. **Switch off and pull out the mains plug.**
2. Remove any frozen food. Wrap in several layers of newspaper or a

blanket, remove the empty baskets and use them to store the wrapped food - put them in a cool place.

3. Remove the freezer and lower compartment doors. This is done by opening the compartment door 45 degrees and gently lifting and pushing the left hand corner so that the pin comes up and out of the special hinge. The door can then be removed from the right hand hinge by pulling the door to the left. To replace each door after cleaning: ensure that the upper door pins are positioned in front of the hinges. Fit the right hand bottom door pin into the bottom hole in the right hand hinge. Locate the bottom left hand pin through the back slot in the left hand hinge. Press down on the top left corner of the door so that the pin goes fully home.
4. Place bowls of hot water in the Fast Freeze compartment and lower compartment. **Do not** use any other heat source.
5. As soon as the frost begins to melt use the plastic scraper to remove it.

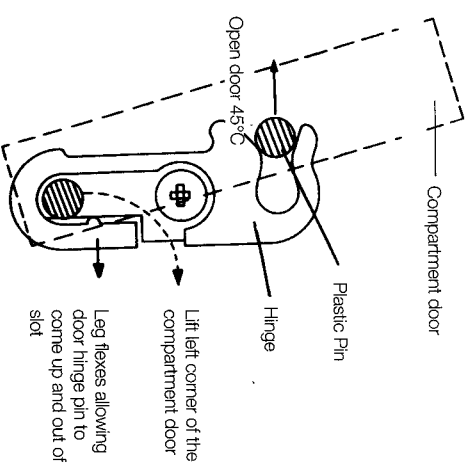

Storing Food (cont.)

| Model | Max storage | Max storage time with door closed if power fails | Max Weight for fast freezing in 24 Hours |
|-------|-------------|--|--|
| 86410 | 20kg (44lb) | 19 Hours | 4kg (8.8lb) |
| 86411 | 32kg (70lb) | 15.5 Hours | 10kg (22lb) |
| 86412 | 32kg (70lb) | 15.5 Hours | 12kg (22lb) |

Storing food in your freezer

Your freezer is rated ****** which indicates that it is suitable for the long-term storage of commercially frozen foods and also can be used to freeze and store fresh food.

Generally speaking long-term storage means up to 3 months, but this will vary with the nature of the packaged food, so always follow the manufacturer's recommended storage time given on the packet. For storing home frozen fresh food refer to the pictorial guide on the door liner.

Freezing fresh foods

1. It is not necessary to alter the control setting. See page 8.
2. Place the fresh food into the freezer compartments with as much food as possible in contact with the floor. You may find water droplets forming on the outside of the cabinet whilst freezing fresh foods. Do not worry as they will disappear when freezing is over.

Do's and Don'ts

Fridge compartment

- Do:-** Take off any unusable leaves on vegetables and wipe off any soil.
- Do:-** Leave lettuce, cabbage, parsley and cauliflower on the stem.
- Do:-** Wrap cheese tightly in greaseproof paper and a polythene bag excluding as much air as possible. For best results take out of the fridge compartment an hour before eating.
- Do:-** Wrap raw meat and poultry loosely in polythene or aluminium foil. This prevents drying.
- Do:-** Wrap fish and offal in polythene bags.
- Do:-** Wrap foods which have a strong odour or can dry out in polythene bags, aluminium foil or place in airtight containers.
- Do:-** Wrap bread well to keep it fresh.
- Do:-** Chill white wines, beer, lager and mineral water before serving.
- Do:-** Make sure the gutter at the back of the fridge compartment is always clear. Remove any particles of food which may collect there.
- Do:-** Clean your salad drawers regularly.
- Do:-** Keep raw meat and poultry below cooked foods and dairy products.
- Do:-** Keep food for as short a time as possible and adhere to 'sell by' dates.
- Do:-** Ensure that cooked meat and raw meat are packaged separately.
- Do:-** Store food items in the positions recommended by the manufacturers.
- Do:-** Ensure that cooked foods are allowed to cool before storing in the refrigerator.
- Do:-** Store bananas in the fridge compartment.
- Don't:-** Store melon in the fridge compartment. It can be chilled for short periods as long as it is wrapped to avoid it flavouring other food.
- Don't:-** Wash eggs as this removes their natural protective film. Wipe them instead.
- Don't:-** Use eggs straight from the fridge compartment, especially when making cakes or mayonnaise. Allow them to reach room temperature before use.
- Don't:-** Leave the door open for long periods as this will make the fridge/freezer more costly to run.
- Don't:-** Cover the shelves with any protective materials which may obstruct air circulation through them.
- Don't:-** Let anything touch the cooling plate at the back of the fridge compartment.
- Don't:-** Store poisonous or dangerous substances in the fridge. Your fridge has been designed for the storage of edible foodstuffs only.
- Don't:-** Consume food which has been stored for an excessive time in the fridge.
- Don't:-** Let defrosting food or food juices drip onto food in your fridge.