



**Air-Cooled Chillers with *ComfortLink™* Controls
Water-Cooled Chillers with *ComfortLink™* Controls
Rooftop Units with *ComfortLink™* Controls
Navigator™ Accessory Display Module**

Installation Instructions

Part Number 30GT-911---062

Read these instructions completely before attempting to install the Navigator Accessory Display Module. The Navigator module is used on the following units:

UNIT	SIZE
30HK	040-060
30HL	050-060
30HW	018-040
30RB	060-390
48AJ,AK,AW,AY	020-060
50AJ,AK,AW,AY	020-060
48PG	03-28
50PG	03-28
48ZG,ZN	030-105
48ZT,ZW,Z6,Z8	075-105
50ZG,ZN,Z2,Z3	030-105
50ZT,ZW,ZX,ZZ,Z6,Z7,Z8,Z9	075-105

CONTENTS

SAFETY CONSIDERATIONS 1
GENERAL 1
INSTALLATION 1-10
OPERATION 10, 11
CLEANING, SERVICE, AND MAINTENANCE 12

SAFETY CONSIDERATIONS

Installation of this accessory can be hazardous due to system pressures, electrical components, and equipment location (such as a roof or elevated structure).

Only trained, qualified installers and service technicians should install, start up, and service this equipment.

When installing this accessory, observe precautions in the literature, labels attached to the equipment, and any other safety precautions that apply.

- Follow all safety codes.
- Wear safety glasses and work gloves.
- Use care in handling and installing this accessory.

▲ WARNING

To avoid the possibility of electrical shock, open and tag all disconnects before installing this equipment. Be aware that there may be more than one disconnect.

GENERAL

Check Package Contents — Check the accessory package for missing parts or shipping damage. If damage is found, or any part is missing, file a claim with the shipper immediately. The package contains these instructions, carrying bag, and the Navigator display module.

The Navigator module is a portable display that conforms to NEMA (National Electrical Manufacturers Association) 4 specifications for outdoor use in temperatures ranging from -22 F (-30 C) to 158 F (70 C). The Navigator module can be

used to configure and perform service diagnostics on machines equipped with Carrier *ComfortLink* controls.

The Navigator module keypad (see Fig. 1) contains eleven menu LEDs and one Alarm Status LED, all of which are red. The Navigator module is capable of displaying four 24-character lines of information on a back-lit liquid crystal display. The Navigator module has four functional keys: the up arrow (▲), down arrow (▼), **ENTER**, and **ESCAPE** keys.

NOTE: The Navigator module should be removed after use. There is not sufficient space to store the module in the unit control panel. The module will NOT fit between the inner panel and outer cover.



Fig. 1 — Navigator in Display Mode

INSTALLATION

1. The Navigator display module is intended to be a mobile device, so there are no holes in the device for permanent mounting. The module has a magnetic mount that is strong enough to hold the device in place on any clean, dry metal surface.
2. The Navigator module is powered through the *ComfortLink* Main Base Board (MBB). The Navigator module has a modular telephone style (RJ14) connector and should be connected to a specific terminal block in the control box as found in Table 1. This device is intended for use on the LEN (Local Equipment Network) communications bus only. Do NOT connect the Navigator module to the CCN (Carrier Comfort Network®) connector, as it may damage the device.
3. See Fig. 2-8 for Navigator LEN connection locations in the units.
4. See Fig. 9 for Communication board details.

Manufacturer reserves the right to discontinue, or change at any time, specifications or designs without notice and without incurring obligations.







Table 1 — Terminal Block (TB) Locations Containing LEN Connector

UNIT MODEL	LOCATION DESCRIPTION OF TB CONTAINING LEN CONNECTOR
30HK,HL040-060	TB3 can be accessed without opening the control box door. It is located at the upper right corner of the control box.
30HW018-040	TB3 can be accessed without opening the control box door. It is located at the upper right corner of the control box.
30RB060-120	TB3 can be accessed by opening the control box door. It is located at the right side of the hinged display door.
30RB130-300	TB3 can be accessed by opening the left hand (smaller) door of the fan control panel. It is located at the right side of the display panel.
30RB315-390	Unit sizes 30RB315-390 are modular units and thus, accept two Navigator™ modules, one on each unit module. See Table 2.
48PG03-16 (TB1) 48PG20-28 (TB2) 50PG03-16 (TB1) 50PG20-28 (TB2)	Both TBs are accessed by opening the control box door. TB1 (PG03-16) or TB2 (PG20-28) is located in the lower right of the control box.
48AJ,AK,AW,AY020-060 50AJ,AK,AW,AY020-060	TB3 can be accessed by opening the control box door. It is located in the lower center of the control box. NOTE: If the unit is equipped with an Economizer Circuit Board (ECB), the ECB provides an auxiliary RJ14 LEN connector. See product documentation for more detail.
48ZG,ZN,ZT,ZW,Z6,Z8 50ZG,ZN,ZT,ZW,ZX,ZZ,Z2,Z3,Z6,Z7,Z8,Z9	TB3 can be accessed by opening the control box door. It is located to the left of the Scrolling Marquee (display). NOTE: These units provide an auxiliary RJ14 LEN connection on the corner post on the entering air end of the unit. See product documentation for more detail.

Table 2 — 30RB315-390 Modular Unit Combinations

UNIT SIZE	Module A	Module B
30RBA315	30RBA160	30RBA160
30RBA330	30RBA170	30RBA160
30RBA345	30RBA170	30RBA170
30RBA360	30RBA190	30RBA170
30RBA390	30RBA190	30RBA190

LEGEND FOR FIG. 2 - FIG. 8

A — Alarm	IFCB — Indoor Fan Circuit Breaker
AUX — Auxiliary	MMC — Motormaster® Contactor
C — Contactor, Compressor	MMR — Motormaster Relay
CAP — Capacitor	OFC — Outdoor Fan Contactor
CB — Circuit Breaker	PLP — Phase Loss Protection
CB-FN — Circuit Breaker Fan Circuit	RCB — Rooftop Control Board
CB-HT — Circuit Breaker Cooler Heater	LEN — Local Equipment Network
CB-P — Circuit Breaker Pump	MBB — Main Base Board
CCB — Control Circuit Board	NEC — National Electrical Code
CCN — Carrier Comfort Network	PMP — Pump Contactor
CLHR — Cooler Heater Relay	POT — Potentiometer
CR — Control Relay	RRB — Reverse Rotation Board
CS — Current Sensor	SW — Switch
CSB — Current Sensor Board	TB — Terminal Block
DS — Disconnect Switch	TDR — Time-Delay Relay
ECB — Economizer Circuit Board	TRAN — Transformer
EMM — Energy Management Module	TXV — Thermostatic Expansion Valve
EQUIP — Equipment	 Terminal Block Connection
EXV — Electronic Expansion Valve	 Field Power Wiring
EXVB — EXV Board	 Factory Wiring
FB — Fuse Block	 Field Wiring
FB1 — Fan Board 1	 Accessory or Option Wiring
FC — Fan Contactor	 To indicate common potential only, not to represent wiring
GCS — Ground Current Sensing	
GND — Ground	
HACR — Heating, Air Conditioning, and Refrigeration	
IDR — Inducer Draft Relay	
IFC — Indoor Fan Contactor	

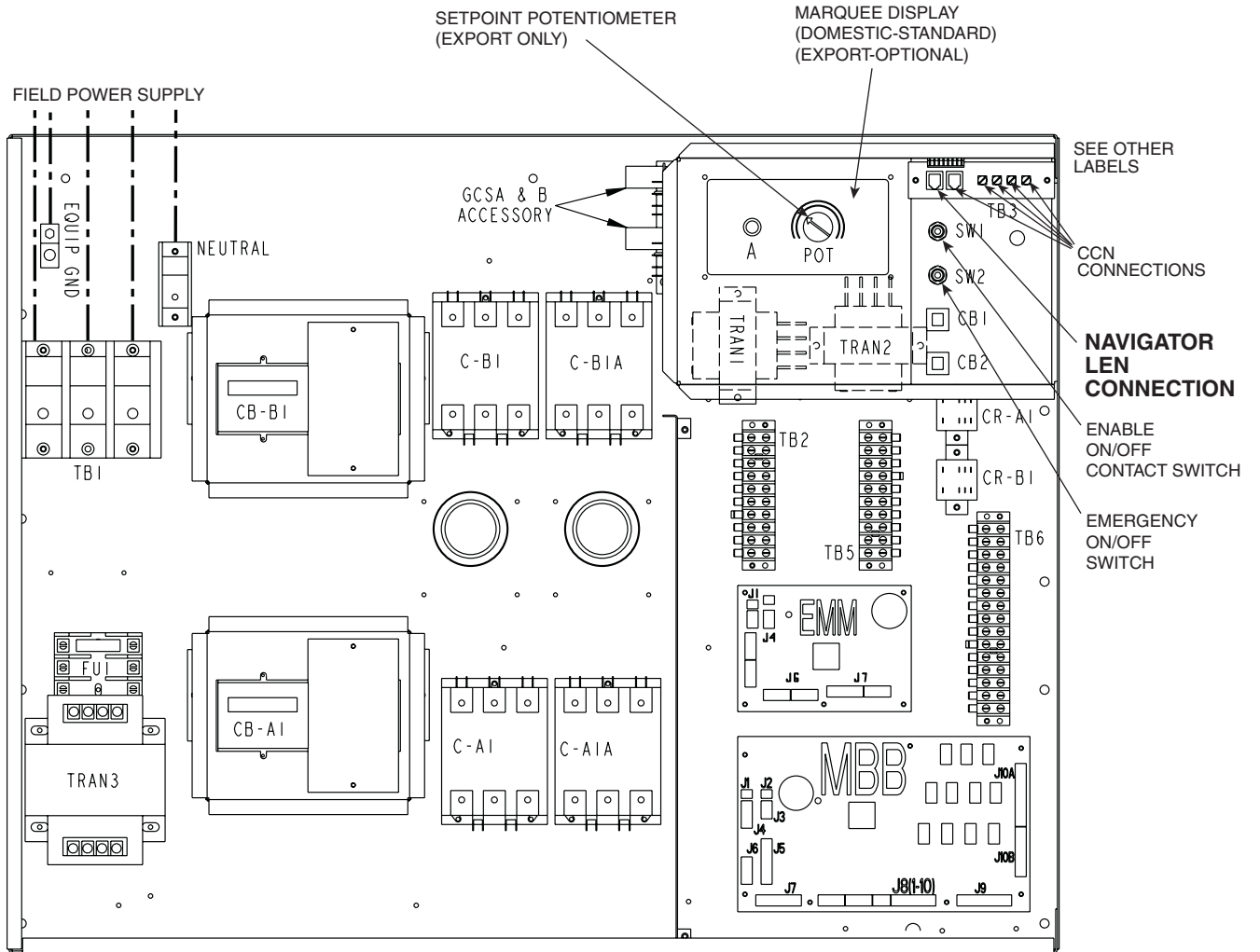

Fig. 2 — 30HK,HL040-060 Units Navigator™ LEN Connection

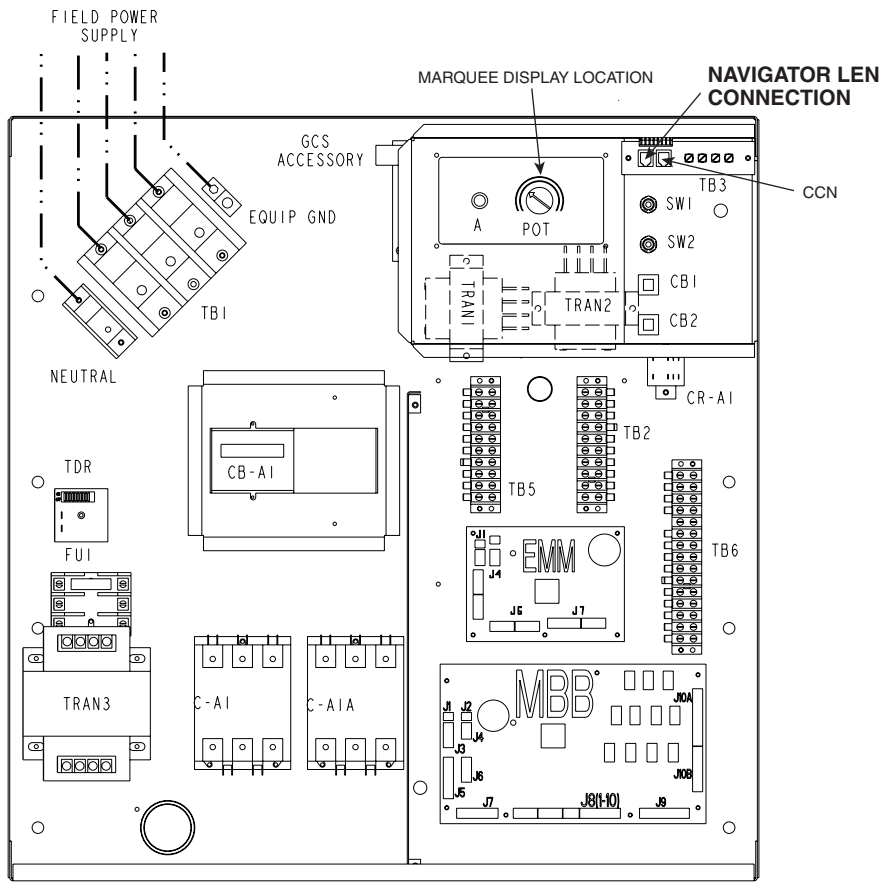

Fig. 3 — 30HW018-040 Units Navigator™ LEN Connection

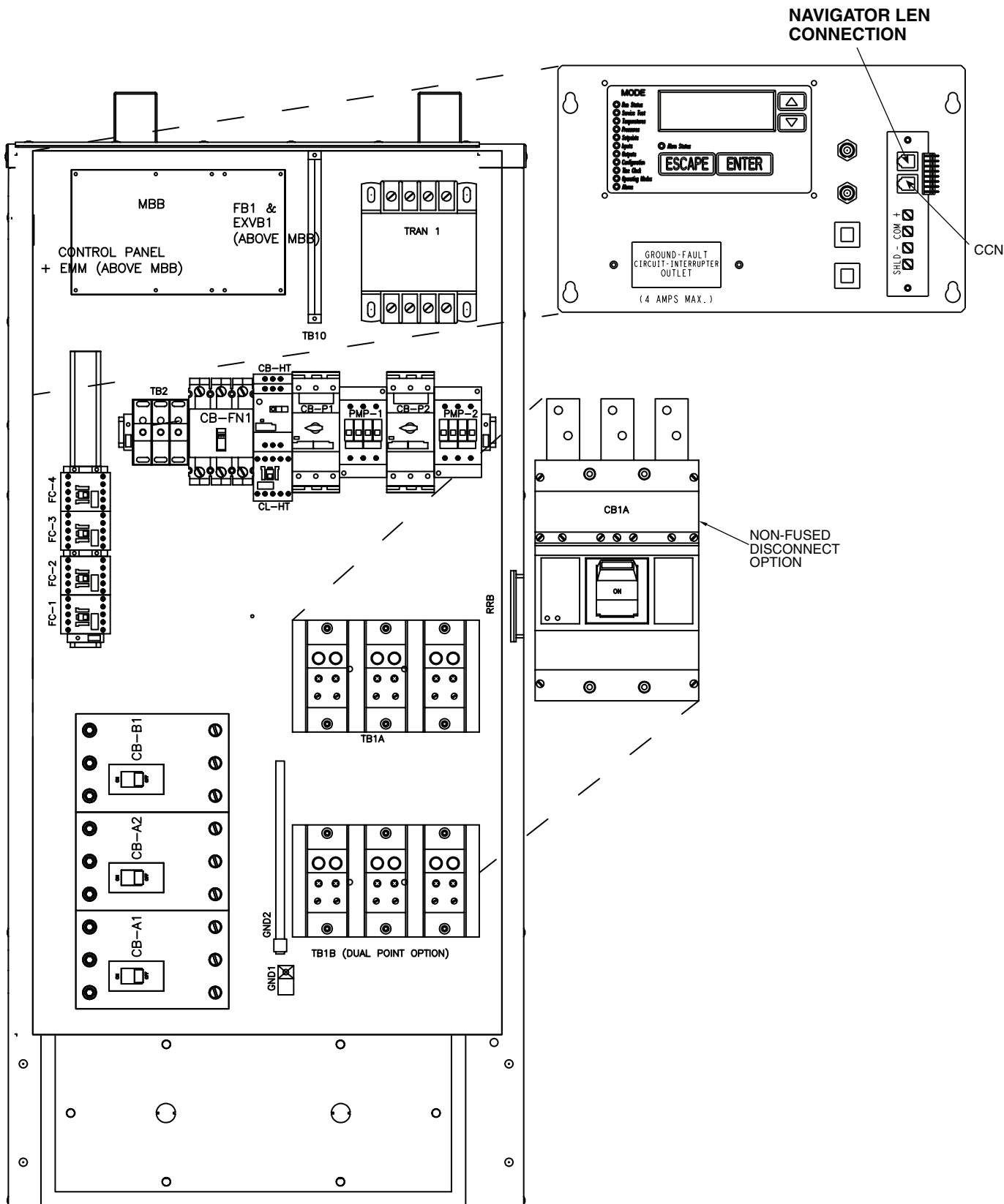

Fig. 4 — 30RB060-120 Units Navigator™ LEN Connection

NAVIGATOR LEN CONNECTION

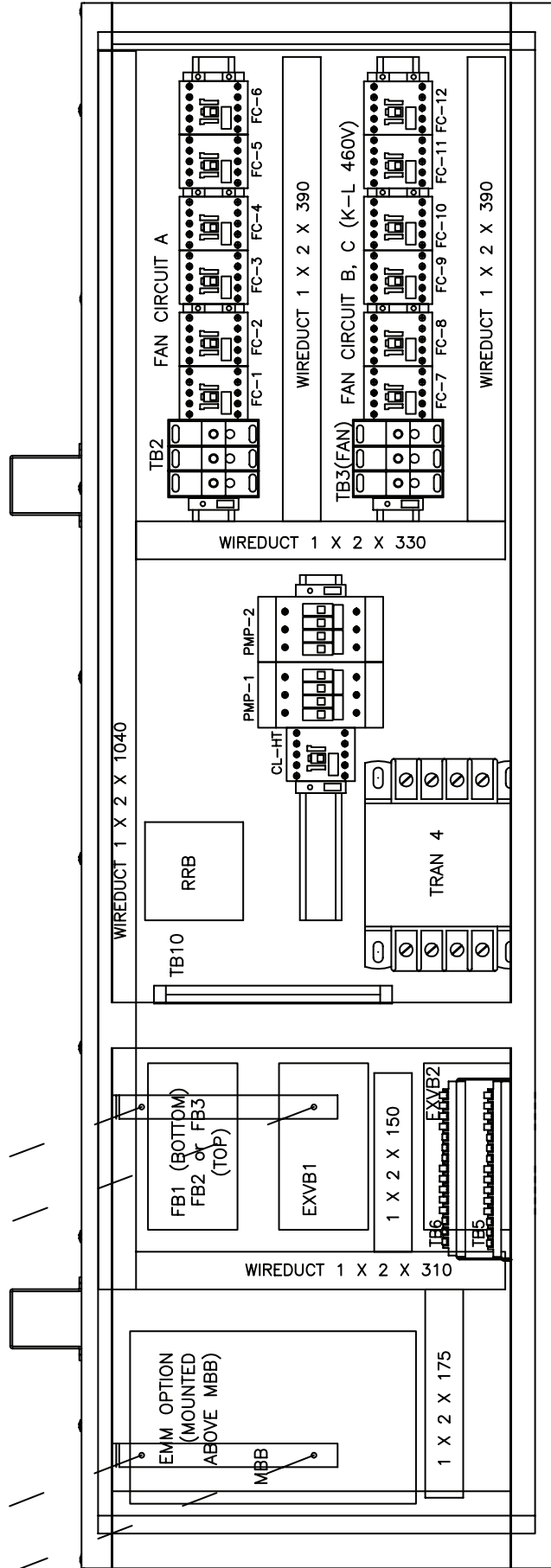
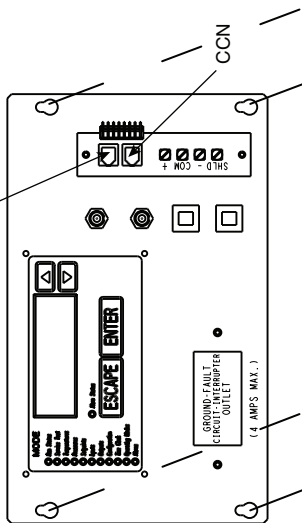

Fig. 5 — 30RB130-300 Units Navigator™ LEM Connection

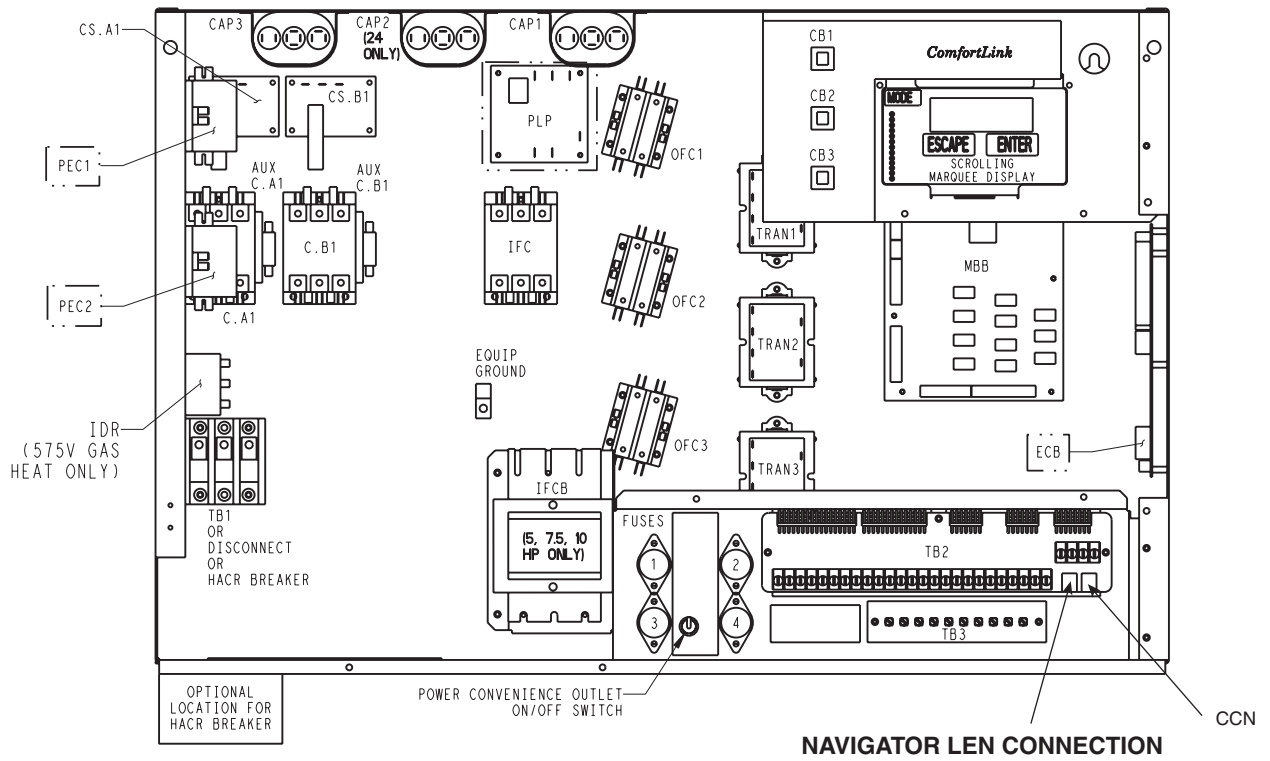

Fig. 6 — Typical 48/50PG Series Navigator™ LEN Connection

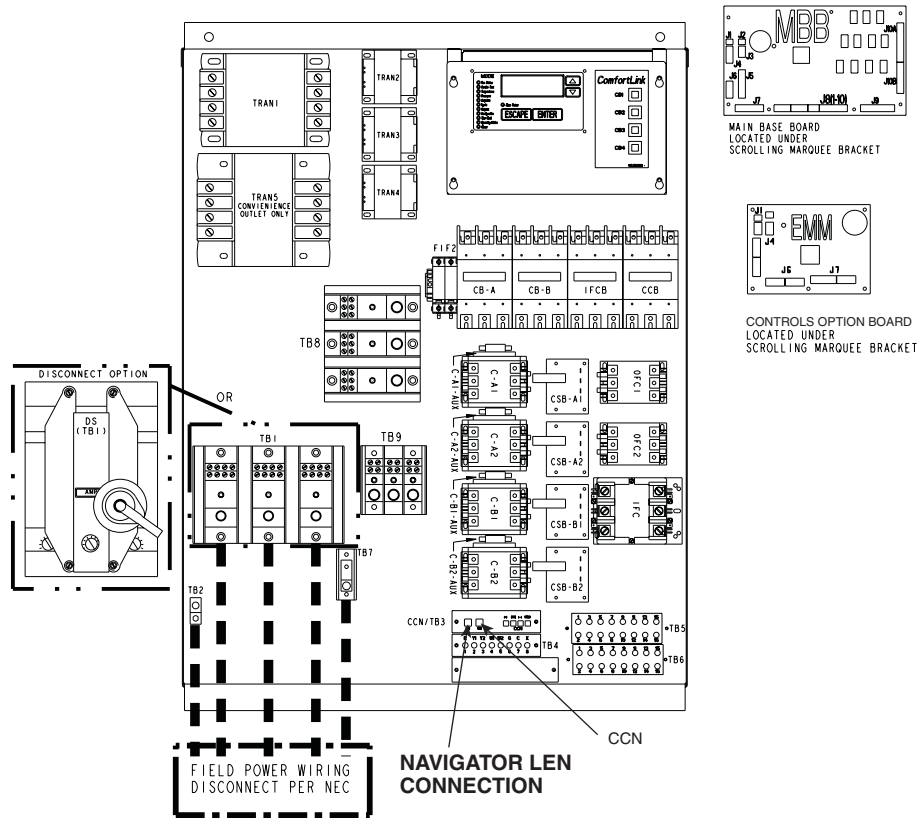

Fig. 7 — Typical 48/50A Series Navigator™ LEN Connection

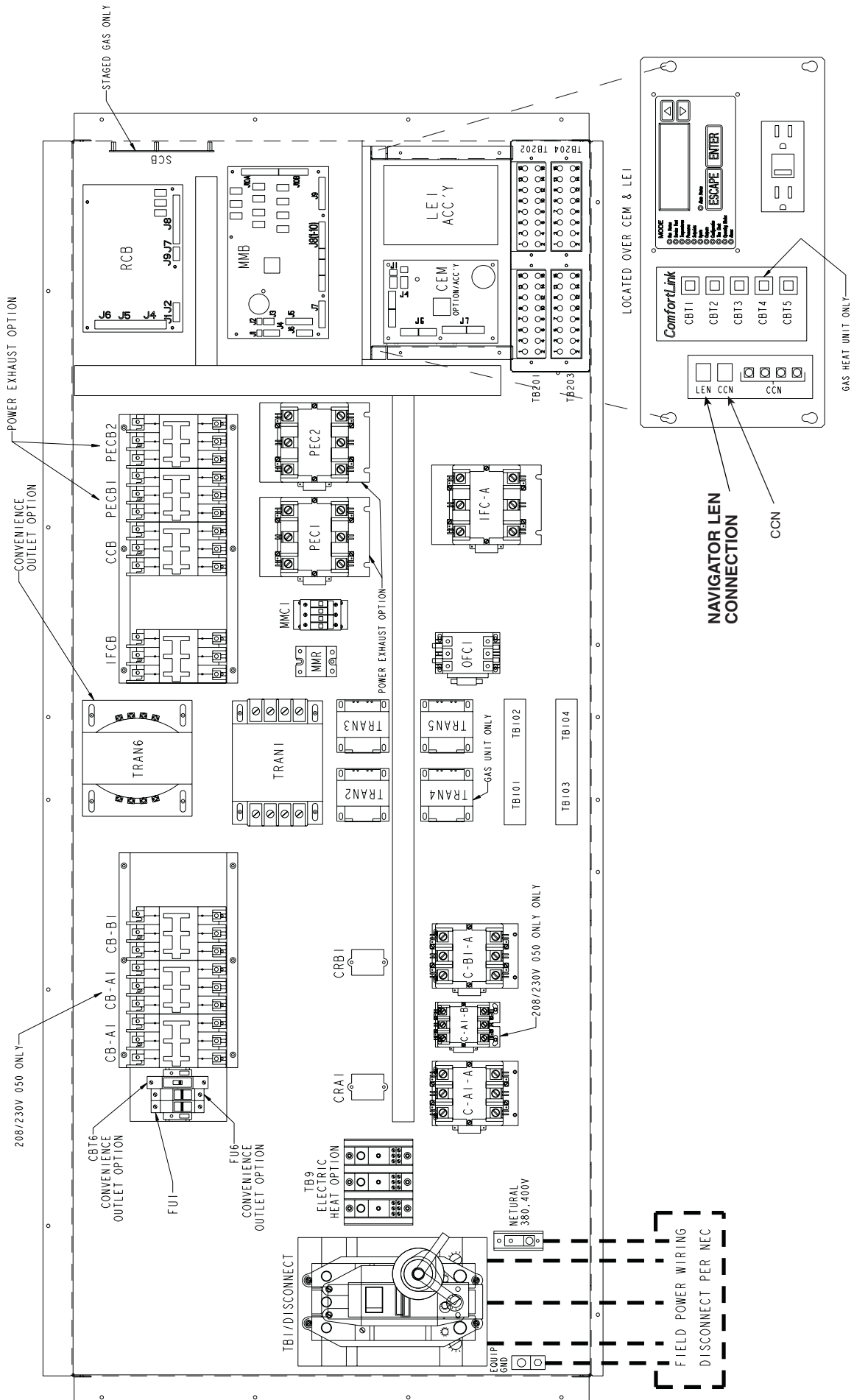
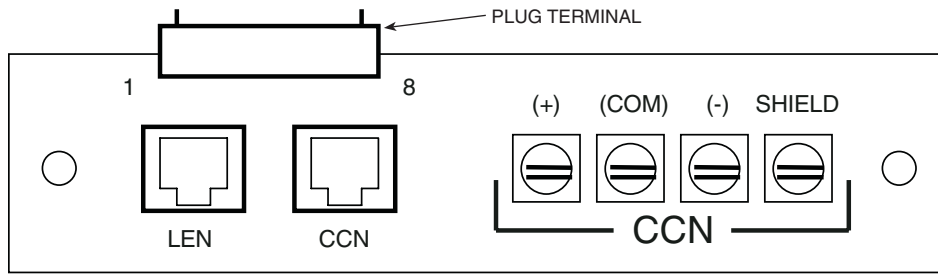

Fig. 8 — Typical 48/50Z Series Navigator™ LEN Connection



TERMINAL BLOCK DETAIL

30 Series Chillers (HK,HL,HW,RB)		Packaged Rooftop Units (PG,A,Z)	
PLUG TERMINAL	TRACE TO	PLUG TERMINAL	TRACE TO
PIN 1	LEN PLUG, PIN 2	PIN 1	CCN SCREW '-'
PIN 2	LEN PLUG, PIN 3	PIN 1	CCN PLUG, PIN 5
PIN 3	LEN PLUG, PIN 5	PIN 2	CCN SCREW 'COM'
PIN 4	LEN PLUG, PIN 1	PIN 2	CCN PLUG, PIN 3'
PIN 4	CCN PLUG, PIN 1	PIN 3	CCN SCREW '+'
PIN 5	LEN PLUG, PIN 6	PIN 3	CCN PLUG, PIN 2
PIN 5	CCN PLUG, PIN 6	PIN 4	CCN PLUG, PIN 6
PIN 6	CCN PLUG, PIN 5	PIN 4	LEN PLUG, PIN 6
PIN 6	CCN SCREW '-'	PIN 5	CCN PLUG, PIN 1
PIN 7	CCN PLUG, PIN 3'	PIN 5	LEN PLUG, PIN 1
PIN 7	CCN SCREW 'COM'	PIN 6	LEN PLUG, PIN 5
PIN 8	CCN PLUG, PIN 2	PIN 7	LEN PLUG, PIN 3
PIN 8	CCN SCREW '+'	PIN 8	LEN PLUG, PIN 2

Fig. 9 — Communication Board Detail

OPERATION

To use the Navigator™ module, plug the RJ14 connector into the LEN port. On power up, the Navigator module displays:

ComfortLink
Navigator
By
Carrier

The Navigator module will upload the appropriate display tables from the Main Base Board (MBB) that it is connected to. A 'Communication failure' message will be displayed if any errors are encountered. Check the wiring at the connector and the MBB-J5 plug if necessary. After successful upload of information, the Navigator module begins its default display. An example of the display in the default mode is:

EWT 54.2 °F
ENTERING FLUID TEMP

The entire local display command structure can be accessed with the Navigator module. Pressing any key while in the default display mode will cause the Navigator module to enter its manual mode. In this mode, all sub-modes and items of the local display command structure, denoted on the display screen, can be accessed. The Navigator module automatically

returns to the default display mode after 60 seconds of no keypad activity. Pressing the **ENTER** and **ESCAPE** keys simultaneously while the unit displays "Select a menu item" will also return the device to its default display mode.

Navigating through Menu Structures — The arrow keys are used to scroll through the tiered command menu structure. See the base unit Controls, Start-Up, Operation, and Service Guide for menu structure. The **ENTER** key is used to select a menu item or to accept data entry. The **ESCAPE** key is used to exit to the next highest command level (mode) or to cancel data entry. The sub-mode and item displays will wrap around with the last and first items separated by a line of dashes on the display. The '>' symbol is the pointer and is located at the left side of the display.

At any time, press the **ESCAPE** key repeatedly as needed to display "Select a menu item" on the screen. This is the top level and the arrow keys are used to move the red LED to one of the 11 desired modes. Press **ENTER** to display the sub-modes within a top level mode.

Use the arrow keys to move the pointer ('>') to the desired sub-mode. Up to four sub-modes will be displayed on the Navigator module at one time. Continue pressing the arrow keys as needed to find the desired sub-mode.

Password Protection — If an area is entered that is password protected or an item is selected for change that is password protected, the Navigator™ module will display:

Enter Password

The first digit of the password will be flashing. Hold either of the arrow keys down to change the value of the first digit (if necessary) and press **ENTER** to accept. Repeat the process for the remaining three digits.

Password for 30RB units is 0111.

Password for all other units is 1111.

The message “Invalid Password” is displayed if the password is not correct. The password can be disabled from the Navigator module, and can be changed.

Forcing Values and Configuring Items — Certain items are allowed to be forced and other items are user-configurable. Both of these changes can be made using the Navigator module. See the unit’s Control, Start-Up, Service and Troubleshooting Guide for a list of forcible and configurable values.

To force an item, position the pointer at the item. Press the **ENTER** key and if the point can be forced or configured, its current value will flash. Use the arrow keys to adjust the temperature to the desired value. Press the **ENTER** key when finished. The Navigator module will display a lowercase ‘f’ to the right of the value if it has been forced. If no ‘f’ is displayed, the item was configurable. To clear a force, press **ENTER** so that the value is again flashing. Simultaneously press the up and down arrow keys. The value will stop flashing, the ‘f’ will be removed, and the parameter will revert to its corresponding input channel value.

To edit a user-configurable item, operate the unit in Service Test mode, or reset current alarms or history, and use the **ENTER** key to make the value flash. Next, use the arrow keys to adjust the item to the desired value and press **ENTER**.

Adjusting the Contrast — The contrast of the display can be adjusted to suit ambient conditions. To adjust the contrast of the Navigator module, press the **ESCAPE** key until the display reads, “Select a menu item.” Using the arrow keys, scroll to the Configuration mode and press **ENTER**. Using the arrow keys, scroll to “DISP” (display) and press **ENTER**. The display will read:

```
>TEST      OFF
METR       OFF
LANG       ENGLISH
```

Pressing **ENTER** will cause the “OFF” to flash. Use the up or down arrow to change “OFF” to “ON”. Pressing **ENTER** will illuminate all LEDs and display all pixels in the view screen. Pressing **ENTER** and **ESCAPE** simultaneously allows the user to adjust the display contrast. The display will read:

Adjust Contrast

-----+-----

Use the up or down arrows to adjust the contrast. The screen’s contrast will change with the adjustment. Press **ENTER** to accept the change. The Navigator module will keep this setting as long as it is plugged in to the LEN bus.

Adjusting the Backlight and Brightness — The backlight of the display can be adjusted to suit ambient lighting conditions. The factory default is set to the highest level. To adjust the backlight of the Navigator module, press the **ESCAPE** key until the display reads, “Select a menu item.” Using the arrow keys, scroll to the Configuration mode and press **ENTER**. Using the arrow keys, scroll to “DISP” (display) and press **ENTER**. The display will read:

```
>TEST      OFF
METR       OFF
LANG       ENGLISH
```

ADJUSTING BRIGHTNESS — Pressing **ENTER** will cause the “OFF” to flash. Use the up or down arrow keys to change “OFF” to “ON”. Pressing **ENTER** will illuminate all LEDs and display all pixels in the view screen. Pressing **▲** and **▼** simultaneously allows the user to adjust the display brightness. The display will read:

Adjust Brightness

-----+-----

Use the up or down arrow keys to adjust the brightness. The screen’s brightness will change with the adjustment. Press **ENTER** to accept the change. The Navigator module will keep this setting as long as it is plugged in to the LEN bus.

CLEANING, SERVICE, AND MAINTENANCE

Cleaning — The Navigator™ module can be cleaned with a mild detergent. Isopropyl alcohol or a glass cleaner can be used on all Navigator module surfaces.

Connection Cord/Plug Assembly Replacement — If the RJ14 plug is damaged, it can be replaced. If it is replaced, the wiring to the plug must be identical to the original plug. Use Fig. 10 to record wire color. The wire sequence should be the same for both ends of the cable as shown in Fig. 10.

The connection cable (P/N 912-990010-2) can be replaced if damaged. Replacement cables are available from Replacement Components Division. Remove the Navigator module from the LEN connection before proceeding.

1. Remove the 6 screws from the back of the case to gain access to the internal plug for the device, and keep them for installation later.
2. The back cover is connected to the touch pad by a ribbon cable. The ribbon cable is not long enough to allow the two halves to be completely separated. To be able to access the plug connection, slightly offset the back cover. Be careful not to damage the ribbon cable.
3. Unplug the damaged cable.
4. Plug in the new cable.
5. Insert the rubber grommet (included with new cable assembly) into the cable entrance hole.

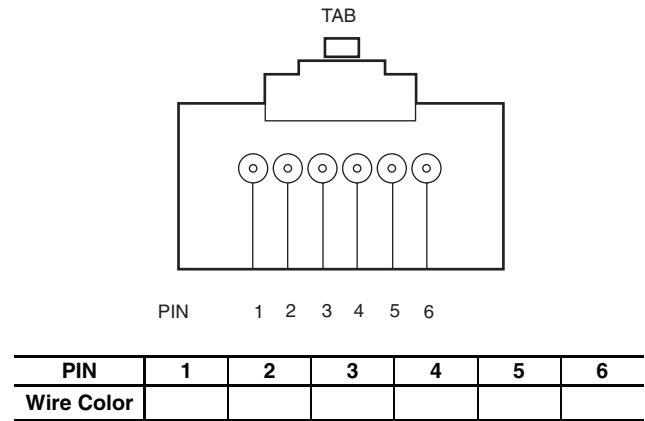

Fig. 10 — Pin/Plug Assembly

6. Realign the two halves of the Navigator module. Be sure that the grommet is properly seated in the cable entrance hole.
7. Reinstall the 6 screws previously removed.

NOTE: Failure to properly seal the Navigator module with the screws and grommet will compromise the watertight integrity of the device.