

## Installation, Operating and Maintenance Instructions

For use with Centrifugal Liquid Chillers

### SAFETY CONSIDERATIONS

**Centrifugal liquid chillers are designed to provide safe and reliable service when operated within design specifications. When operating this equipment, use good judgement and safety precautions to avoid damage to equipment and property or injury to personnel.**

**Be sure you understand and follow the procedures and safety precautions contained in the machine instructions as well as those listed in this guide.**

#### ▲ DANGER

DO NOT VENT refrigerant relief valves within a building. Outlet from rupture disc or relief valve must be vented outdoors in accordance with the latest edition of ANSI/ASHRAE 15 (Safety Code for Mechanical Refrigeration). The accumulation of refrigerant in an enclosed space can displace oxygen and cause asphyxiation.

PROVIDE adequate ventilation in accordance with ANSI/ASHRAE 15, especially for enclosed and low overhead spaces. Inhalation of high concentrations of vapor is harmful and may cause heart irregularities, unconsciousness, or death. Intentional misuse can be fatal. Vapor is heavier than air and reduces the amount of oxygen available for breathing. Product causes eye and skin irritation. Decomposition products are hazardous.

DO NOT USE OXYGEN to purge lines or to pressurize a machine for any purpose. Oxygen gas reacts violently with oil, grease and other common substances.

NEVER EXCEED specified test pressures. VERIFY the allowable test pressure by checking the instruction literature and the design pressures on the equipment nameplate.

DO NOT VALVE OFF any safety device.

BE SURE that all pressure relief devices are properly installed and functioning before operating any machine.

#### ▲ WARNING

DO NOT WELD OR FLAME CUT any refrigerant line or vessel until all refrigerant (*liquid and vapor*) has been removed from chiller. Traces of vapor should be displaced with dry air or nitrogen and the work area should be well ventilated. *Refrigerant in contact with an open flame produces toxic gases.*

DO NOT USE eyebolts or eyebolt holes to rig machine sections or the entire assembly.

DO NOT work on high-voltage equipment unless you are a qualified electrician.

DO NOT WORK ON electrical components, including control panels, switches, starters or oil heater until you are sure ALL POWER IS OFF and no residual voltage can leak from capacitors or solid-state components.

LOCK OPEN AND TAG electrical circuits during servicing. IF WORK IS INTERRUPTED, confirm that all circuits are de-energized before resuming work.

DO NOT syphon refrigerant by mouth.

AVOID SPILLING liquid refrigerant on skin or getting it into the eyes. USE SAFETY GOGGLES. Wash any spills from the skin with soap and water. If any enters the eyes, IMMEDIATELY FLUSH EYES with water and consult a physician.

NEVER APPLY an open flame or live steam to a refrigerant cylinder. Dangerous overpressure can result. When necessary to heat refrigerant, use only warm (110 F/43 C) water.

DO NOT REUSE disposable (nonreturnable) cylinders nor attempt to refill them. It is DANGEROUS AND ILLEGAL. When cylinder is emptied, evacuate remaining gas pressure, loosen the collar and unscrew and discard the valve stem. DO NOT INCINERATE.

CHECK THE REFRIGERANT TYPE before charging machine. High-pressure refrigerant in a low-pressure machine can cause vessels to rupture if the relief devices cannot handle the refrigerant volume.

Operation of this equipment with refrigerants other than those cited herein should comply with ANSI/ASHRAE-15 (latest edition). Contact Carrier for further information on use of this machine with other low-pressure refrigerants.

DO NOT ATTEMPT TO REMOVE fittings, covers, etc. while machine is under pressure or while machine is running. Be sure pressure is at zero psig before breaking any refrigerant connection.

CAREFULLY INSPECT all relief valves, rupture discs and other relief devices AT LEAST ONCE A YEAR. If machine operates in a corrosive atmosphere, inspect the devices at more frequent intervals.

DO NOT ATTEMPT TO REPAIR OR RECONDITION any relief valve when corrosion or build-up of foreign material (rust, dirt, scale, etc.) is found within the valve body or mechanism. Replace the valve.

DO NOT install relief devices in series or backwards.

USE CARE when working near or in line with a compressed spring. Sudden release of the spring can cause it and objects in its path to act as projectiles.

#### ▲ CAUTION

DO NOT STEP on refrigerant lines. Broken lines can whip about and cause personal injury.

DO NOT climb over a machine. Use platform, catwalk or staging. Follow safe practices when using ladders.

USE MECHANICAL EQUIPMENT (crane, hoist, etc.) to lift or move inspection covers or other heavy components. Even if components are light, use such equipment when there is a risk of slipping or losing your balance.

BE AWARE that certain automatic start arrangements CAN ENGAGE THE STARTER. Open the disconnect *ahead* of the starter in addition to shutting off the machine or pump.

USE only repair or replacement parts that meet the code requirements of the original equipment.

DO NOT VENT OR DRAIN water boxes containing industrial brines, liquid, gases or semisolids without permission of your Process Control Group.

DO NOT LOOSEN water box cover bolts until the water box has been completely drained.

DOUBLE-CHECK that coupling nut wrenches, dial indicators or other items have been removed before rotating any shafts.

DO NOT LOOSEN a packing gland nut before checking that the nut has a positive thread engagement.

PERIODICALLY INSPECT all valves, fittings and piping for corrosion, rust, leaks or damage.

PROVIDE A DRAIN connection in the vent line near each pressure relief device to prevent a build-up of condensate or rain water.

## CONTENTS

	Page
<b>SAFETY CONSIDERATIONS</b> .....	1
<b>INTRODUCTION</b> .....	2
<b>INSTALLATION</b> .....	2
<b>Identify Unit</b> .....	2
<b>Inspect Shipment</b> .....	2
<b>Rig Unit Properly</b> .....	2
<b>Make Piping Connections</b> .....	2
• RUPTURE DISC	
• CHILLER PREPARATION	
<b>Make Electrical Connections</b> .....	4
<b>Optional Caster Installation</b> .....	4
<b>CONTROLS AND COMPONENTS</b> .....	4
<b>Vacuum Pump</b> .....	4
<b>Heater</b> .....	4
<b>Pressure Switches</b> .....	4
<b>Condenser</b> .....	4
<b>Level Gage</b> .....	4
<b>Charging Hoses</b> .....	5
<b>OPERATING INSTRUCTIONS</b> .....	5
<b>Evacuation</b> .....	5
<b>Pressurization</b> .....	5
<b>Liquid Refrigerant Transfer</b> .....	5
<b>Refrigerant Vapor Transfer</b> .....	6
<b>Oil Separation</b> .....	6
<b>Water Separation</b> .....	7
<b>MAINTENANCE</b> .....	7
<b>Vacuum Pump</b> .....	7

### INTRODUCTION

The 19QA Refrigerant Management System (Fig. 1) has been designed to help owners and operators of centrifugal chillers conserve low pressure refrigerant and prevent the release of refrigerant into the atmosphere. The proper use of this equipment will minimize the loss of R-11 and will allow for relatively easy recycling of refrigerant which has been contaminated with water or excessive amounts of lubricating oil.

The 19QA is available with a tank size of 20 or 40 cu. ft. Also available are optional casters for use with the 20-cu ft tank only. For 19QA specifications, see controls and components section, page 4. Physical data is shown in Table 1.

### INSTALLATION

**Identify Unit** — Identify the model number and serial number printed on the nameplate located just below the accessory case. Check this information against job data.

#### Inspect Shipment

#### ▲ CAUTION

Do not open valves or break any connections. The unit is shipped under vacuum.

Inspect for shipping damage while unit is still on shipping conveyance. If unit appears damaged, have it inspected by transportation inspectors before removal. Forward claim papers directly to the transportation company. Manufacturer is not responsible for damage incurred in transit.

Check all items against the parts list in Fig. 1. Notify nearest office of Carrier Air Conditioning immediately if any item is missing. To prevent loss or damage, leave all parts in original packages until installation.

**Rig Unit Properly** — Lift unit only from the 4 lifting holes provided or by means of a fork lift using the fork holes in the blank end of the unit. When using a fork lift, insert the forks their full length to avoid denting the bottom of the tank. Do not use a fork lift when the tank contains liquid.

#### ▲ WARNING

Lifting unit from points other than those specified above may result in serious damage and personal injury.

Rigging equipment and procedures must be adequate for unit weight. Refer to Fig. 2.

**Make Piping Connections** — Most connections between vacuum pump, condenser, tank and chiller can be made using the refrigerant charging hoses provided in accessory case. (See Fig. 1 and 3.) Field-supplied copper tubing and valve manifolds may be installed if desired.

**RUPTURE DISC** — The 19QA is factory equipped with a one-in. rupture disc assembly (see Fig. 1).

Vent relief device to the outdoors in accordance with ANSI/ASHRAE 15-1989 Safety Code for Mechanical Refrigeration and all applicable codes.

#### ▲ DANGER

Refrigerant discharged into confined spaces can displace oxygen and cause asphyxiation.

Use one-in. pipe minimum for one-in. rupture disc. Provide a flexible connection as required to prevent piping stress on the rupture disc. Provide fittings so vent piping can be disconnected periodically for inspection of disc.

Cover outdoor vent with a rain cap and place a condensate drain (field-supplied) at the low point in vent piping to prevent water build-up on the atmospheric side of rupture disc.

**CHILLER PREPARATION** — Install the 3/4-in. MPT by 1/2-in. male flare fitting in the chiller charging valve to be compatible with the charging hose connection.

Install the chiller vapor valve (1/2-in. ball valve with male 1/2-in. MPT and flare connections provided) by drilling and tapping a hole or welding a coupling into the vapor space area of the chiller. Be careful not to drill in an area where heat exchanger tubes are present. A good location for tapping a hole is the suction box area. This connection will be used to pressurize the chiller when removing liquid refrigerant and to remove refrigerant vapor.

Install a field-supplied 1/4-in. copper line between the bottom of the motor and the top of the evaporator. This line will drain liquid refrigerant which is normally trapped in the bottom of the motor to the evaporator when the chiller is shut down and greatly reduce the amount of time required to remove refrigerant vapor from the chiller.

#### ▲ CAUTION

Be very careful not to drill into the motor windings when tapping the hole in the bottom of the motor housing.

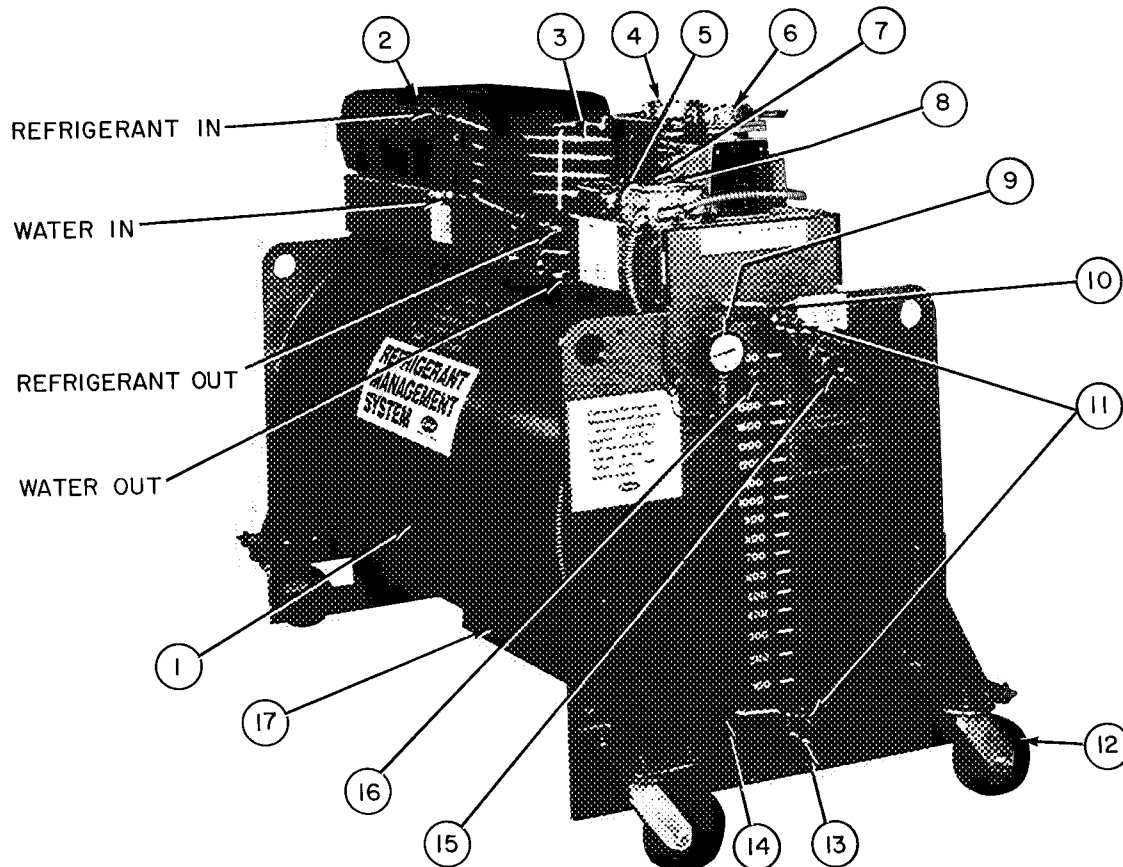

- |   |   |
|---|---|
| <p><b>NO. ITEM</b></p> <p>1 - Storage Tank</p> <p>2 - Accessory Case</p> <p>Charging Hose, 3 ft</p> <p>Charging Hose, 6 ft (2)</p> <p>Charging Hose, 12 ft</p> <p>Valve With Coupler (2)</p> <p>Chiller Vapor Valve</p> <p>Liquid Ind. With Coupler</p> <p>Filter-Drier 1/2-in Flare</p> <p>3/4-in. MPT x 1/2-in Male Flare</p> <p>3 - Tube-In-Tube Condenser</p> <p>4 - Vacuum Pump</p> <p>5 - Heater High Pressure Switch</p> | <p><b>NO. ITEM</b></p> <p>6 - Vacuum Pump High Pressure Switch, Hidden</p> <p>7 - Vacuum Pump Switch</p> <p>8 - Heater Switch</p> <p>9 - Pressure Gage</p> <p>10 - Vapor Valve</p> <p>11 - Level Gage Valve</p> <p>12 - Optional Casters - Available for Small (20 cu ft) Tank Only</p> <p>13 - Liquid Valve</p> <p>14 - Water Separation Glass</p> <p>15 - Rupture Disc</p> <p>16 - Maximum Level Glass</p> <p>17 - Heater</p> |
|---|---|

**Fig. 1 - 19QA Component Identification**

**Table 1 - Physical Data**

19QA	ENGLISH			SI		
	Size	020	040	Size	020	040
<b>DRY WEIGHT</b>	lbs	605	820	kg	275	370
<b>TANK SIZE</b>	cu ft	20	40	cu meters	.57	1.13
<b>TANK STORAGE CAPACITY</b> R-11 Liquid	lbs	1600	3300	kg	725	1500
<b>DESIGN PRESSURE</b>	psig	15		kPa	103	
<b>MAX. OPERATING PRESSURE</b>	psig	10		kPa	69	
<b>CONNECTION SIZES</b>	in.	1/2		in.	1/2	
<b>HIGH PRESSURE SWITCHES</b> Tank Heater and Vacuum Pump Cutout Manual Reset	psig psig	10 <4		kPa kPa	69 <28	
<b>VACUUM PUMP</b> PSC Motor Hp		1/2			1/2	
<b>Max. Discharge Pressure</b>	psig	10		kPa	69	
<b>Max. Vacuum</b> One Pump 2 Pumps in Series	in. Hg	25.5 29		kPa	86 98	
<b>Flow Rate</b> 60 Hz 50 Hz	cfm	3.6 3.0		m <sup>3</sup> /s	.0017 .0014	

PSC - Permanent Split Capacitor

UNIT SIZE	A	B	WEIGHT EMPTY		MAX. REFRIG CHARGE	
			lbs	kg	lbs	kg
19QA020	4'-9" [1447.80]	5'-17/8" [1571.75]	605	275	1600	725
19QA040	9'-9" [2971.80]	10'-17/8" [3095.75]	820	370	3300	1500

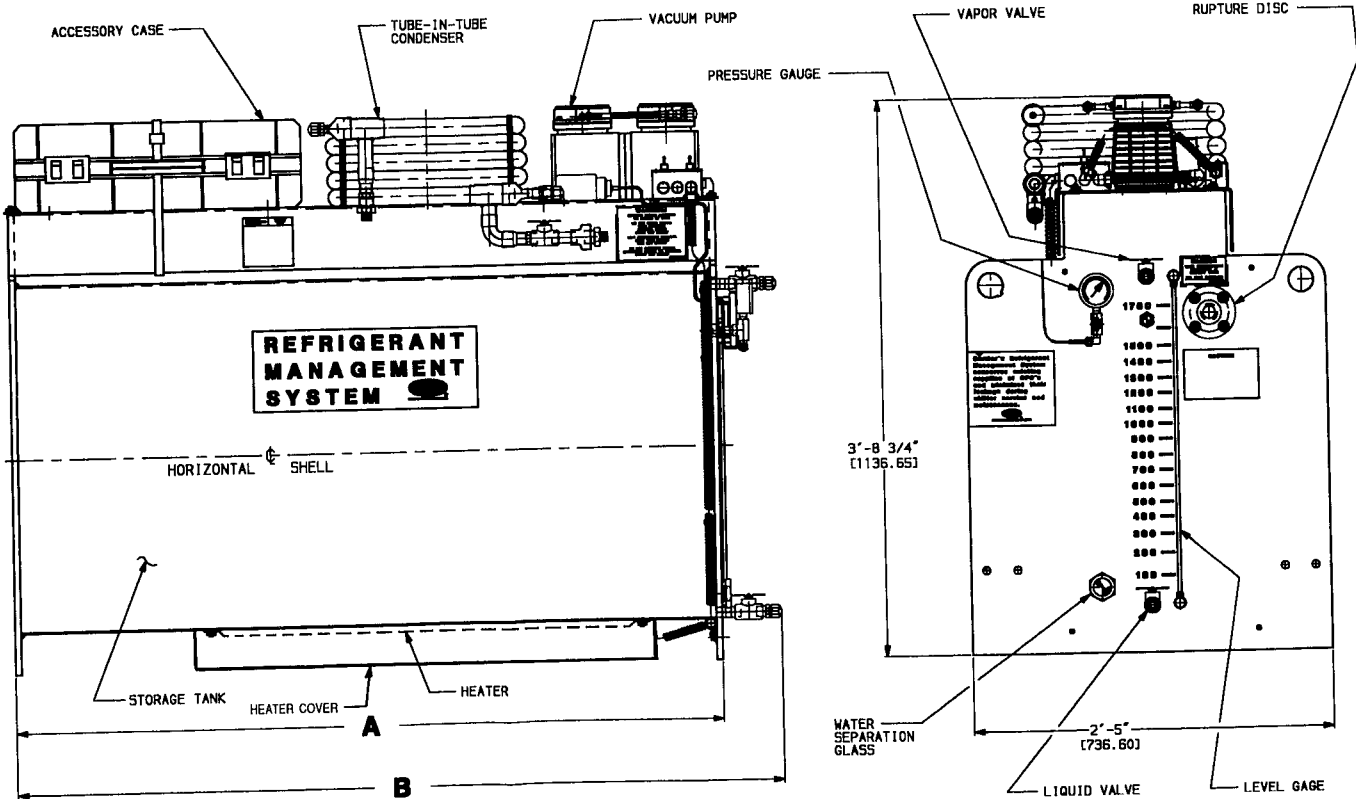
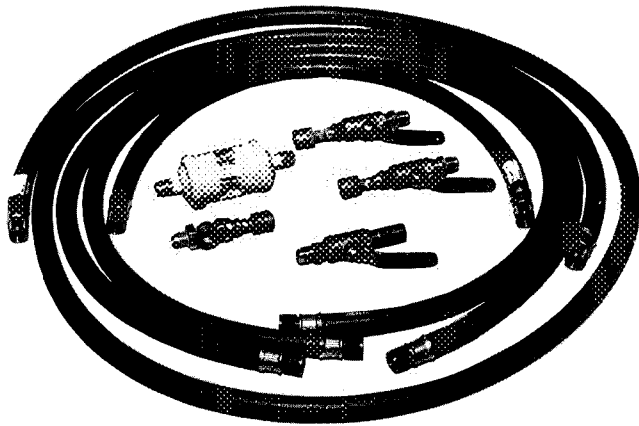

Fig. 2 – 19QA Dimensions



**Fig. 3 — Accessory Case Contents**

**Make Electrical Connections** — Connect electrical power in accordance with the minimum circuit amps and maximum overcurrent protection amps as specified on the unit nameplate. Be sure that the unit is connected and grounded in accordance with applicable codes. See Table 2.

→ **Table 2 — Electrical Data**

VOLTS-PH-HZ	115-1-60	115-1-50
MCA	12	12
MOCP (Amps)	15	15
HEATER Amps	4	4
VACUUM PUMP MOTOR Hp Amps	½ 4.9	½ 5.5

MCA — Minimum Circuit Amps

MOCP — Maximum Overcurrent Protection (Amps)

NOTE: Use time-delay fuse.

**Optional Caster Installation** — If optional casters have been provided, bolt the four caster assemblies to the tank. The optional casters are not strong enough to be used with the 40-cu ft tank.

**⚠ WARNING**

Always lock and block caster wheels after moving tank. Use extreme care when moving tank on casters if floor is not level.

**CONTROLS AND COMPONENTS**

See Fig. 4 for control wiring.

**Vacuum Pump** — The diaphragm type vacuum pump design reduces the probability of refrigerant leaks. The flow rate for this pump (free air) is 3.6 cfm (.0017 m<sup>3</sup>/s) for 60 Hz and 3.0 cfm (.0014 m<sup>3</sup>/s) for 50 Hz. The approximate maximum vacuum is 25.5 in. Hg (86 kPa) for a single pump and 29 in. Hg (97 kPa) for two pumps in series. The pump is capable of discharging to a pressure of 10 psi (68 kPa).

The pump is equipped with a permanent split capacitor motor which is controlled with a toggle switch. The pump is not designed to start against a head pressure or suction vacuum. The pressure across the pump must be equalized before attempting a start. If pressurization or evacuation must be temporarily stopped, leave the pump running and close off a valve in the suction side.

**Heater** — A 500-Watt electric heater is attached to the bottom of the storage tank. This heater is controlled by a toggle switch and is required when oil is being separated from the refrigerant by distillation.

**⚠ WARNING**

Do not touch heater when energized; personal injury burns may result. Keep combustible material away from heater, fire may result. Do not submerge heater; electrical shorts or personal injury may result.

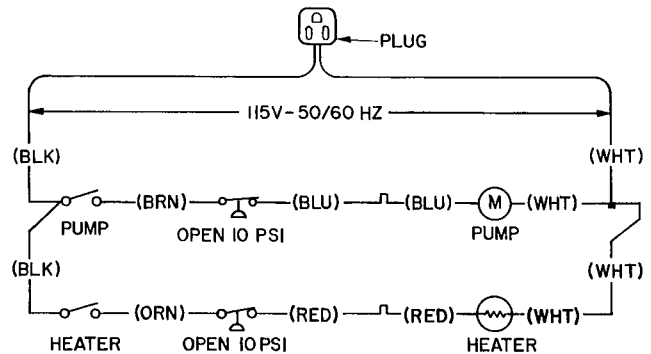

**Fig. 4 — Control Schematic**

**Pressure Switches** — Manual reset high-pressure switches, set at 10 psi (69 kPa), are provided to protect against over-pressurization. One switch will limit the tank pressure by shutting off the tank heater. The second switch will limit the vacuum pump discharge pressure by shutting off the vacuum pump. The switches may be reset by pressing the reset button on the cover after the pressure has been reduced below 4 psi (28 kPa).

**Condenser** — A tube-in-tube condenser allows refrigerant vapor to be condensed when removing vapor from a chiller or when distilling refrigerant which contains excess oil. Garden hose connections (¾-in.) are provided for condensing water. Condensing water temperature should be as low as possible to minimize the time required to complete an operation. A water flow rate of one gpm (.00006 m<sup>3</sup>/s at 70 F (21 C) is normally adequate.

**⚠ CAUTION**

Always be sure to drain the water from the condenser when not in use to prevent the possibility of freeze-up.

**Level Gage** — A reflex type sight glass is provided at the 90% full level. The rings show bright when there is no liquid behind the glass and dark when liquid is present.

A level gage consisting of two angle valves and a clear plastic tube allows the liquid level to be pinpointed.

**⚠ CAUTION**

Always leave the two angle valves shut when not using the level gage to avoid the possibility of refrigerant loss in the event the plastic tube is damaged.

A large sight glass is also provided just above the drain valve connection to allow observation of a refrigerant/water interface when separating water from refrigerant.

**Charging Hoses** — Four ½-in. charging hoses with swivel connectors allow easy interconnection of components. Tighten the connectors hand tight only. Excessive tightening torque will damage the integral rubber gaskets. Two ½-in. ball valves with couplers are provided for use with the charging hoses to prevent the loss of refrigerant which is in the hoses at the end of a transfer process. The hoses are designed to withstand high vacuum without collapsing.

## OPERATING INSTRUCTIONS

**Evacuation** — (See Table 3.) If refrigerant loss is to be minimized, air must not be allowed to mix with refrigerant vapor. Refrigerant-containing spaces such as chillers and storage tanks must be completely evacuated before charging with refrigerant.

To evacuate air from a vessel, connect the suction of the vacuum pump to a vapor space connection on the vessel with the shortest possible ½-in. charging hose. If the vessel is initially under a partial vacuum, do not open the suction side valve until the pump is running. Use of undersize hoses or fittings will greatly increase the time required to pull a complete vacuum. For the best possible vacuum, a second pump in series with the pump provided is recommended.

### ⚠ CAUTION

Do not evacuate a chiller from the liquid charging connection. Liquid may be present which could damage the vacuum pump.

### ⚠ CAUTION

Do not start compressor or oil pump motor or apply test voltage of any kind while chiller is under deep vacuum. Motor insulation breakdown and serious damage can result.

**Table 3 — Typical Evacuation Times (Minutes)  
No Liquid Trapped in Chiller**

VESSEL	VACUUM	
	25 in. Hg (86 kPa)	29 in. Hg (97 kPa) 2 Pumps
20-Cu Ft Storage Tank	20	30
40-Cu Ft Storage Tank	40	60
19DK78	180	280
19DK57	95	150
19DK46	50	80

**Pressurization** — (See Table 4.) The vacuum pump can be used to pressurize a chiller or storage tank with air to 10 psi for the purpose of leak testing. Connect the pump discharge to the chiller using a ½-in. charging hose and turn the pump on.

The vacuum pump cannot start against pressure. If the unit is partially pressurized, install a valve on the compressor suction, start the pump, connect the hose to the pump discharge, open the valve to the unit and then open the suction valve.

### ⚠ CAUTION

To avoid the possibility of failing a rupture disc, do not raise the pressure of a 15 psi design vessel above 10 psi.

**Table 4 — Typical Pressurization Time**

VESSEL	TIME (min.)
20 Cu Ft Tank	5
40 Cu Ft Tank	10
19DK78	35
19DK57	20
19DK46	10

## Liquid Refrigerant Transfer

### ⚠ CAUTION

To prevent failure of the rupture disc due to liquid expansion, the storage tank must not be filled above 90% full at 90 F.

The 90% full point is indicated by the reflex sight glass located just below the vapor valve. The maximum charge for the 20 cubic foot tank is 1600 lbs of R-11 and the maximum charge for the 40 cubic foot tank is 3300 lbs. See Table 3 to determine tank charge by the liquid level in the level gage.

Air should be evacuated from any vessel before refrigerant is charged into it.

Refer to Fig. 5. To transfer liquid refrigerant from the storage tank to a chiller, connect a charging hose from the chiller vapor space to the vacuum pump suction and turn on the vacuum pump. Allow about a minute for the vacuum pump to remove the air from the suction hose and then connect a short hose from the pump discharge to the tank vapor valve. Open the tank vapor valve. Connect a hose between the tank drain valve and the chiller charging valve. Open the chiller liquid valve and the chiller vapor valve. The pump discharge pressure must be maintained below 10 psi by throttling the suction of the pump. When the proper amount of charge has entered the chiller, close the charging valves and turn off the pump. This process will transfer about 40 pounds per minute.

To transfer liquid refrigerant from the chiller to the storage tank, the same approach may be used with the pump suction being connected to the tank and the discharge connected to the chiller. This process will transfer about 30 pounds per minute.

It is recommended that a valve be connected to the charging hose at the end that connects to the chiller so that the liquid in the hose is not lost when the hose is removed from the chiller. The liquid indicator should also be connected to the hose at the tank liquid valve end when transferring refrigerant into the tank to determine when all the refrigerant is out of the chiller.

A good approximation of the amount of refrigerant in the tank can be made by measuring the distance from the bottom of the liquid valve pipe nipple to the liquid level in the level gage. (See Table 5.)

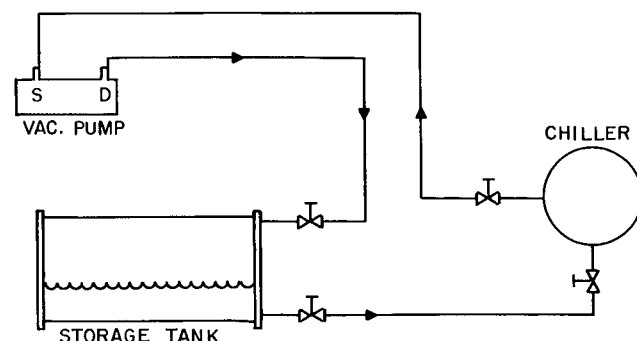

NOTE: All connections are by hoses

**Fig. 5 — Liquid Refrigerant Transfer  
(Transfer from Storage Tank to Chiller Shown)**

**Refrigerant Vapor Transfer** — A large 19DK contains about 95 pounds of refrigerant vapor once the liquid refrigerant has been removed. (See Fig. 6). It is possible to reclaim almost all of this refrigerant by evacuating the chiller and condensing the vapor. Refer to Fig. 7. Connect the vacuum pump suction to the chiller vapor valve. Run the vacuum pump for about one minute to remove the air from the hose. Connect the pump discharge to the upper condenser connection and the lower condenser connection to the tank vapor valve. Open the chiller vapor valve and provide about one gpm of 70 F or cooler water to the condenser. About 8 hours are required to remove most of the refrigerant vapor from a large 19DK chiller. More time will be required if liquid refrigerant is trapped in areas such as the hermetic motor.

**⚠ CAUTION**  
Be sure to run the chiller water pumps when removing refrigerant vapor. Trapped refrigerant liquid may boil and can cause tube freeze-up and extensive damage.

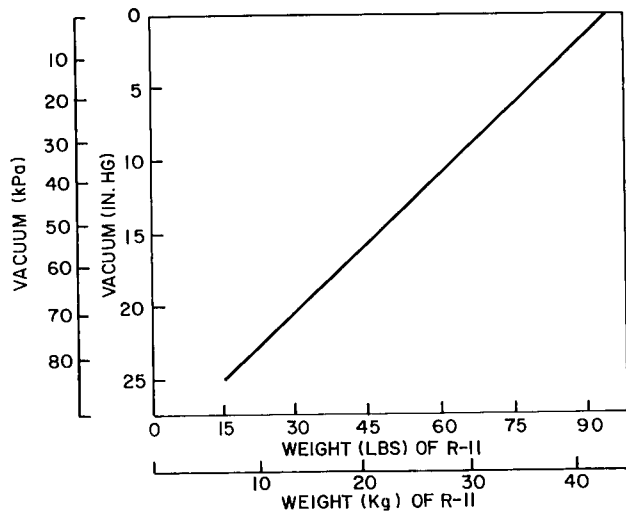

**Fig. 6 — Evacuation**

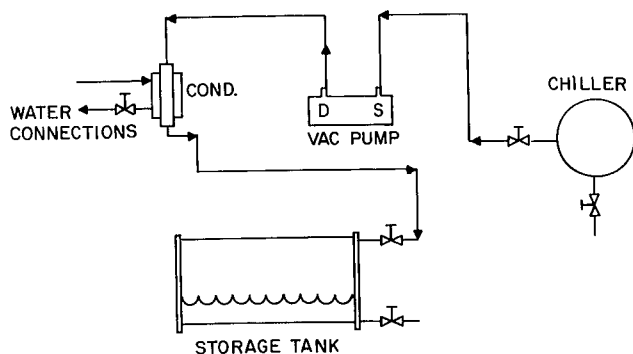

NOTE: All connections are by hoses.

**Fig. 7 — Refrigerant Vapor Transfer/Evacuation**

**Table 5 — Tank Charge Vs Liquid Level**

Tank Size (Cu Ft)			
20		40	
Qty of R-11 (lbs) at 70 F	Liquid Level (Inches from Bottom of Liquid Valve 1/2-in. pipe Nipple)	Qty of R-11 (lbs) at 70 F	Liquid Level (Inches from Bottom of Liquid Valve 1/2-in. pipe Nipple)
100	2.8	200	2.8
200	4.6	400	4.7
300	6.1	600	6.2
400	7.5	800	7.5
500	8.7	1000	8.7
600	10.0	1200	10.0
700	11.3	1400	11.2
800	12.5	1600	12.4
900	13.8	1800	13.5
1000	15.0	2000	14.6
1100	16.2	2200	15.8
1200	17.5	2400	17.0
1300	18.7	2600	18.2
1400	20.0	2800	19.4
1500	21.3	3000	20.6
1600	22.7	3200	21.8
1700	24.5	3400	23.3
—	—	3600	25.3

NOTE: The above values are for a liquid temperature of 70 F. Use the following table to adjust the refrigerant weights at other temperatures:

**Refrigerant Weight Multipliers**

Temp (F)	40	50	60	70	80	90	100
Multiplier	1.029	1.018	1.009	1.000	0.991	0.982	0.973

**Oil Separation** — The refrigerant management system may be used to separate oil from refrigerant through the process of distillation. The refrigerant can be transferred from the chiller to the tank and then distilled back into the chiller or another tank.

Refer to Fig. 8. Connect the vacuum pump suction to the tank vapor valve. Connect the pump discharge to the top connection of the condenser. Connect the condenser lower connection to the chiller charging valve or a second tank. Provide about one gpm of 70 F or cooler water to the condenser. Turn on the vacuum pump and the heater.

**⚠ WARNING**  
Do not touch the heater when energized; personal injury may result. Keep combustible material away from heater; fire may result. Do not submerge heater; electrical shorts or personal injury may result.

If the distilled refrigerant is being returned to the chiller, it would be helpful to run cool water through the heat exchanger. About 60 pounds of refrigerant can be distilled per hour.

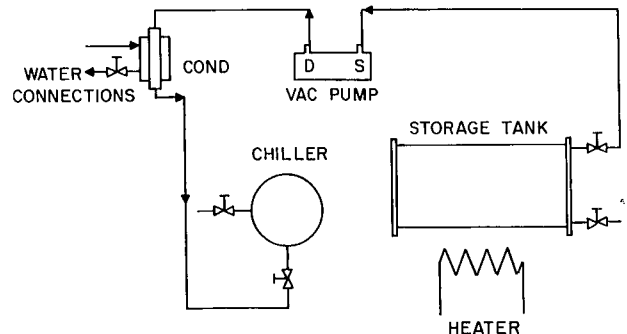

NOTE: All connections are by hoses.

**Fig. 8 — Oil Separation**

**Water Separation** — Water is only slightly soluble in refrigerant, about 110 ppm at normal temperature levels. Almost all the water present will float on top of the refrigerant and can be easily removed using the refrigerant management system.

Transfer the refrigerant and water into the tank. Refer to Fig. 9. Pressurize the tank with air by connecting the pump discharge to the tank vapor valve. Transfer the liquid refrigerant into the chiller or another tank while watching the liquid level. Use the large sight glass at the bottom of the tank to determine when the water/refrigerant interface is just above the liquid valve. It is important to reduce the liquid flow rate as the water level approaches the valve and to shut the valve when the level is about 1/2 in. above the top of the valve to prevent water from being drawn out of the tank.

To reduce the amount of refrigerant dissolved in the refrigerant below saturation, install a filter-drier in the liquid line.

To prevent the loss of the residual refrigerant, the water/refrigerant mixture can be transferred into an open pail, the water skimmed off the top of the refrigerant and the remaining refrigerant transferred into the tank.

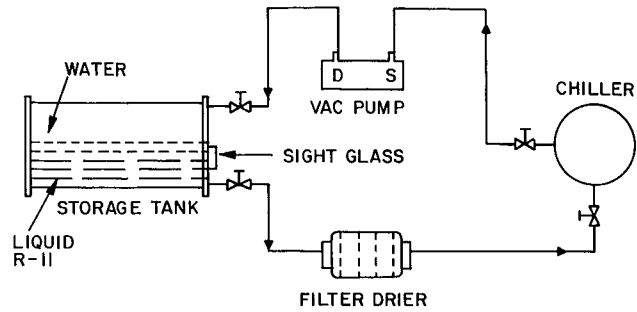

NOTE: All connections are by hoses

**Fig. 9 — Water Separation**

## MAINTENANCE

**Vacuum Pump** — With heavy use, it may be necessary to replace the vacuum pump diaphragm. Repair kits are available from the manufacturer. The vacuum pump also has internal filters which can be replaced.