

jWIN

MINI STEREO MP3 CD / CD PLAYER



Instruction Manual

JX-CD2100



Please read this manual carefully before operating and save it for future reference.

Have a question? Please visit <http://www.jWIN.com>

USER SAFETY GIUDE

IMPORTANT SAFETY INSTRUCTIONS

WARNING: To prevent fire or shock hazard, do not expose this appliance to rain or moisture.



	CAUTION RISK OF ELECTRIC SHOCK DO NOT OPEN	
These markings are located on the bottom, side or back of the unit.		

CAUTION: To prevent the risk of electric shock, do not remove cover (or back). Non- user-serviceable parts inside. Refer servicing to a service professional.

- The lightning flash with an arrowhead symbol, within an equilateral triangle, is intended to alert the user to the presence of un-insulated "dangerous voltage" within the product's enclosure that may be of sufficient magnitude to constitute a risk of electric shock to a person.
- The exclamation point within an equilateral triangle is intended to alert the user to the presence of important operating, maintenance and servicing instructions in the literature accompanying the appliance.

Dripping warning: "This product shall not be exposed to any dripping or splashing, and no objects filled with liquids, such as vases, shall be placed on or near the product."

Ventilation warning: "The normal ventilation of the product shall not be impeded for intended use." (Minimum distances must be kept around the apparatus for sufficient ventilation, especially while use of the apparatus is in tropical and/or moderate climates.)

	Dispose of old batteries safely. Do not throw them into a fire.
	<p>LASER SAFETY This unit utilizes laser technology. Only a qualified professional should remove the cover or attempt to service this device, due to possible eye injury.</p> <p>CAUTION</p> <ul style="list-style-type: none"> • Use of controls or adjustments or performance of procedure other than specified herein may result in hazardous radiation exposure. • Hazardous laser radiation when open and interlock defeated. <p>DANGER Invisible laser radiation when open and interlock failure. Avoid direct exposure to beam.</p>

USER SAFETY GUIDE

INSTRUCTIONS ON ENVIRONMENT PROTECTION

Do not dispose of this product in the usual household garbage at the end of its life cycle; bring it to a collection point for the recycling of electrical and electronic appliances. This symbol on the product means the instructions for use or the packing will inform about the methods for disposal. The materials are recyclable as mentioned in its marking. By recycling, material recycling, or other forms of re-utilization of old appliances, you make an important contribution to protect the environment. Please inquire at your local community administration for the authorized disposal location.



IMPORTANT SAFETY PRECAUTIONS

1. **READ INSTRUCTIONS** - All safety and operating instructions should be read before the appliance is operated.
2. **RETAIN INSTRUCTIONS** - The safety and operating instructions should be retained in a secure place for future reference.
3. **HEED WARNINGS** - All warnings on the appliance and in the operating instructions should be observed.
4. **FOLLOW INSTRUCTIONS** - All operating and use instructions should be followed.
5. **WATER AND MOISTURE** - The appliance should not be used near water. For example: near a bathtub, kitchen sink, laundry tub, and swimming pool or even in a wet basement.
6. **VENTILATION** - The appliance should be situated so that its location and position does not interfere with its proper ventilation. For example, the appliance should not be situated on a bed, sofa, rug or similar surface that may block the ventilation openings; or, be placed in a built-in installation, such as a bookcase or cabinet that may impede the flow of air through the ventilation openings.
7. **HEAT** - The appliance should be situated away from heat sources such as radiators, heat registers, stoves, or other appliances (including amplifiers) that produce heat.
8. **POWER SOURCES** - The appliance should be connected to a power supply only of the type described in the operating instructions or as marked on the appliance.
9. **GROUNDING AND POLARIZATION** - Precautions should be taken to ensure that the grounding or polarization of the appliance is correct.
10. **POWER CORD PROTECTION** - Power supply cords should be routed so that they are not likely to be walked on or obstructed by items placed upon or against them. Pay particular attention to cords at plugs, convenience receptacles, and the point at which they exit from the appliance.
11. **CLEANING** - The appliance should be cleaned only as recommended by the manufacturer.
12. **POWER LINES** - An outdoor antenna should be located away from power lines.
13. **NONUSE PERIODS** - The power cord of the appliance should be unplugged from the outlet when the appliance is to be left unused for an extended period of time.

USER SAFETY GUIDE

IMPORTANT SAFETY PRECAUTIONS – CONTINUED

14. **OBJECT and LIQUID ENTRY** - Care should be taken so that objects do not fall and liquids are not spilled into the device's openings.
15. **CARTS AND STANDS** - The appliance should be used only with a cart or stand that is recommended by the manufacturer. An appliance and cart combination should be moved with care. Quick stops, excessive force, and uneven surfaces may cause the appliance and cart combination to overturn. 
16. **WALL OR CEILING MOUNTING** - If the appliance is mounted to a wall or ceiling, it should be mounted only as recommended by the manufacturer.
17. **DAMAGE REQUIRING SERVICE** - The appliance should be serviced by qualified service professional when:
 - a. The power-supply cord or plug has been damaged.
 - b. Objects have fallen into, or liquid has been spilled into the appliance's apertures.
 - c. The appliance has been exposed to rain.
 - d. The appliance has been dropped and suffered damage.
 - e. The appliance does not appear to operate normally or exhibits a marked change in performance.
18. **SERVICING** - The user should not attempt to service the appliance beyond that described in the user's operating instructions. All other servicing should be referred to qualified service professional.
19. **PROTECTIVE ATTACHMENT PLUG** - The appliance is equipped with an attachment plug that has an overload protection. This is a safety feature. If replacement of the plug is required, be sure the service technician has used a replacement plug specified by the manufacturer that has the same overload protection as the original plug. (UK Version Only)

FCC NOTICE (USA)

This device complies with Part 15 of the FCC Rules. Operation is subject to the following two conditions: (1) this device may not cause harmful interference, and (2) this device must accept any interference received, including interference that may cause undesired operation.

FCC regulations state that any change or modification to the equipment, not expressly approved by maker or its authorized parties, could void user's authority to operate this equipment.

- To prevent fire or electric shock, do not expose the unit to rain or moisture.
- Never attempt to open the cabinet. Dangerous high voltages are present in the unit. Always refer servicing to a qualified technician.

IC NOTICE (CANADA)

This digital apparatus does not exceed the Class B limits for radio noise emissions from digital apparatus as set out in the Radio Interference Regulations of Industry Canada.

TABLE OF CONTENTS

1. Getting Started	
a. Introduction	5
b. Location of Controls (top, speaker, right, left)	6
c. Location of Controls (Back Panel)	7
d. Location of Controls (Remote)	7
e. Connecting the Speakers	8
f. AC Operation	8
g. Antennas	8
h. Listening with Stereo Headphones	8
i. Installing the Batteries in the Remote Control	8
2. Operational Instructions	
a. Loading a CD into the Player	9
b. Listening to CDs	9
c. Repeat Mode	10
d. Skip and Search Mode	10
e. Program Mode	10
f. Listening to the Radio	11
g. FM Stereo Indicator	11
h. Bass Boost	11
3. Maintenance & Specifications	
a. Notes on CDs	12
b. Cleaning the lens	12
c. Cleaning the cabinet	12
d. Troubleshooting.....	13
e. Technical specifications	14

GETTING STARTED

Thank you for purchasing the JX-CD2100. Unpack the unit and make sure to put aside all accessories so they will not be lost. We recommend that you retain the original carton and packaging materials for future use, should you transport or ship the unit in the future.

Mini Stereo MP3 CD / CD Player

- 20-track programmable memory
- Bass boost system (BBS)
- Skip and search function
- Integrated AM / FM stereo radio
- Liquid crystal display (LCD) with blue backlight
- 3.5mm Aux. in jack and stereo headphone jack
- Playable media: CD / CD-R / CD-RW / MP3 CD

What's included

- Mini Audio System
- Remote Control
- Instruction Manual
- Warranty Card



GETTING STARTED

Location of Controls

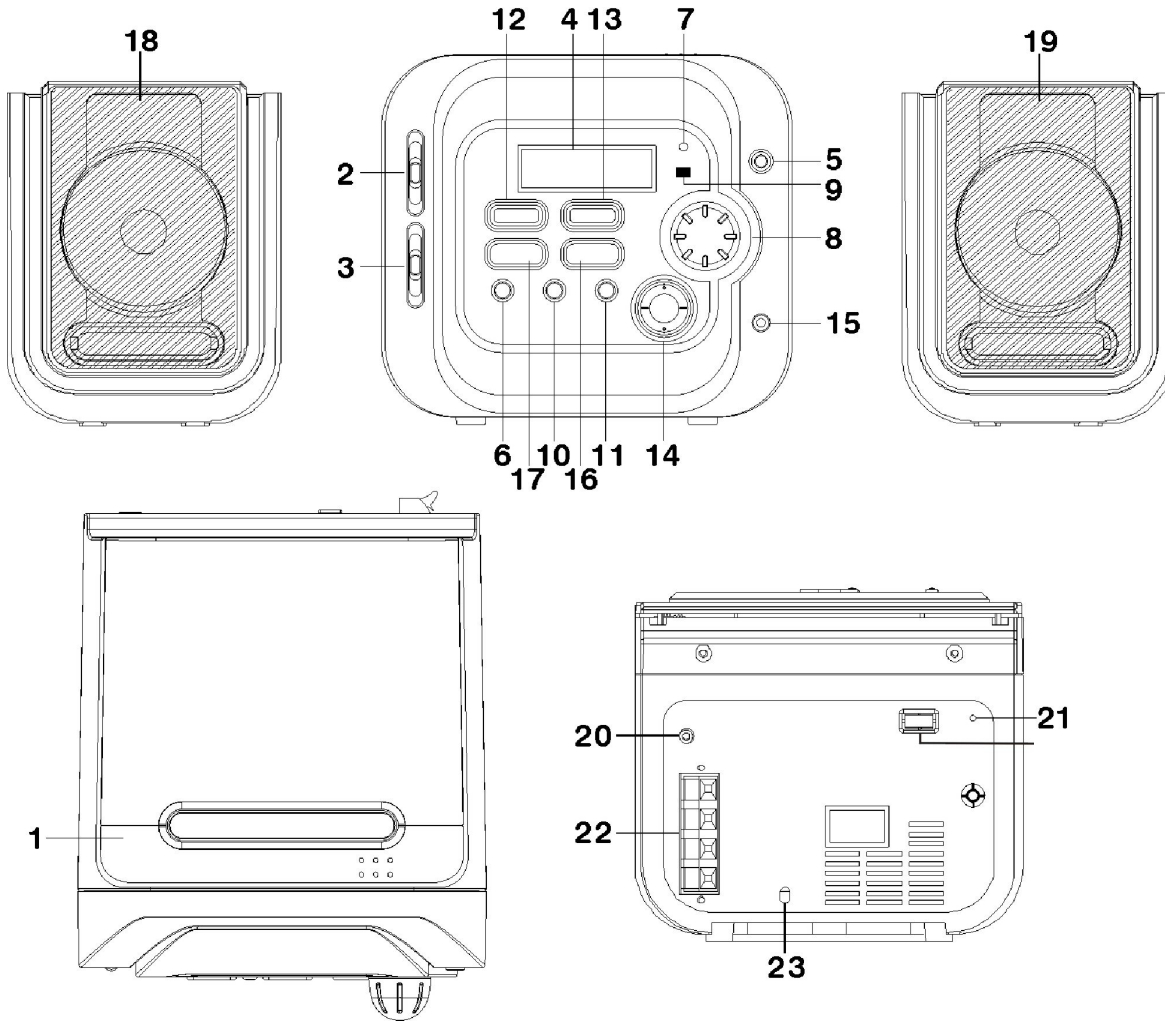

1. CD DOOR
2. FUNCTION SWITCH (AUX / CD / RADIO)
3. BAND SWITCH
4. LCD SCREEN
5. POWER (ON / OFF) BUTTON
6. BASS BOOST BUTTON
7. STANDBY LED INDICATOR
8. TUNING KNOB
9. REMOTE SENSOR
10. CD PROGRAM BUTTON
11. CD MODE BUTTON
12. CD STOP (■) BUTTON

13. CD PLAY / PAUSE (▶ ||) BUTTON
14. VOLUME CONTROL
15. STEREO HEADPHONE JACK
16. CD FOLDER BUTTON (◀ DOWN/ ▶ UP)
17. CD SKIP / SEARCH (◀◀ BACKWARD / ▶▶ FORWARD) BUTTON
18. LEFT SPEAKER
19. RIGHT SPEAKER
20. AUX IN JACK
21. FM ANTENNA
22. SPEAKER TERMINAL (L / R)
23. AC POWER CORD

GETTING STARTED

Location of Controls (Remote Control)

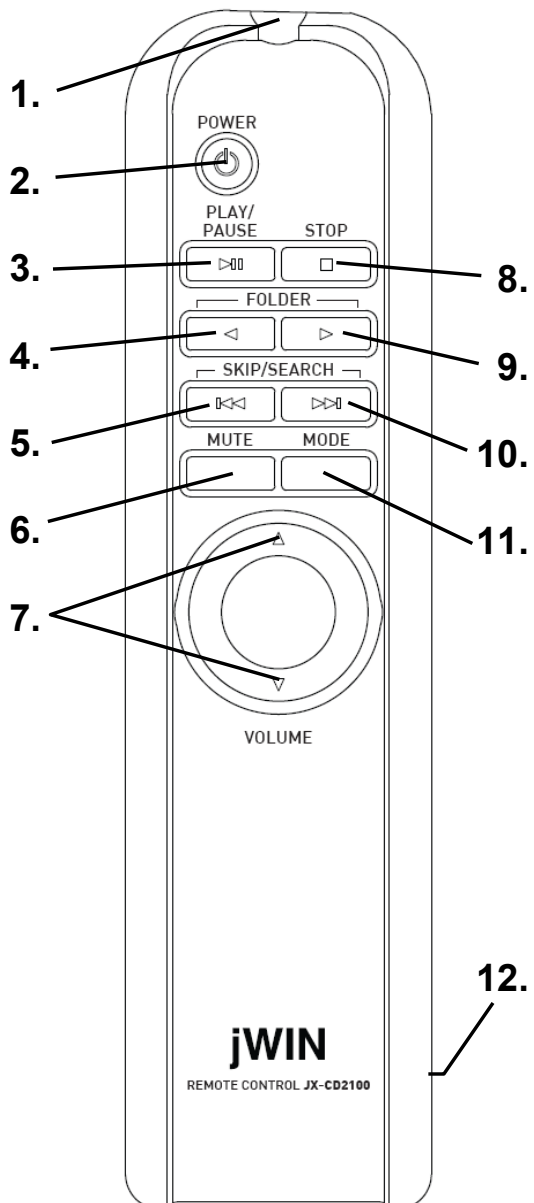

1. INFRARED SENSOR
2. POWER BUTTON
3. PLAY/PAUSE BUTTON
4. FOLDER DOWN BUTTON
5. SKIP/SEARCH DOWN BUTTON
6. MUTE BUTTON
7. VOLUME UP/DOWN BUTTON
8. STOP BUTTON
9. FOLDER UP BUTTON
10. SKIP/SEARCH UP BUTTON
11. MODE BUTTON
12. BATTERY DOOR (REAR)

Note: For best results, point the infrared transmitter on the remote control directly at the remote sensor on the main unit.

GETTING STARTED

Connecting the Speakers

Connect the **SPEAKER** cables to the **SPEAKER** terminals in the rear of the unit properly.

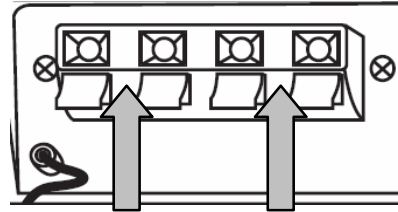

AC Operation

Before operating this unit, make sure the voltage indicated on the JX-CD2100 matches the voltage in the wall outlet.

1. Plug the **AC POWER CORD** into a standard AC wall outlet.

STANDBY/
MUTE



2. The **STANDBY/MUTE INDICATOR** will light.

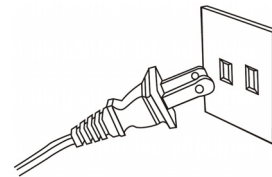

3. Press the **POWER** button. The **LCD DISPLAY** will light and the **STANDBY/MUTE INDICATOR** will go off.

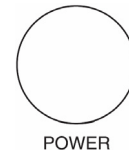

Antennas

For best FM reception, fully extend the FM antenna. For AM reception, this unit has a built-in antenna.

Listening with Stereo Headphones

For private listening, insert the 3.5mm plug of a stereo headphone set (not included) into the **STEREO HEADPHONE JACK** on the left side panel of the JX-CD2100. Volume on the headphones is controlled by the **VOLUME** knob on the unit or the **VOLUME +/-** button on the remote control. When headphones are used, sound on the external speakers cuts off.

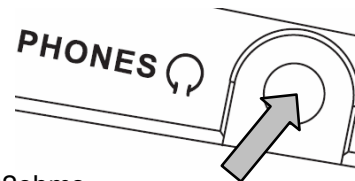

Note: Be sure that your headphones have an impedance of 32ohms.

Installing Batteries in the Remote Control

1. Slide open the **BATTERY DOOR** in the direction of the arrow imprinted on the door itself.
2. Install two (2) AA size batteries according to the polarity (+/-) marked inside the compartment.
3. Close the **BATTERY DOOR**.

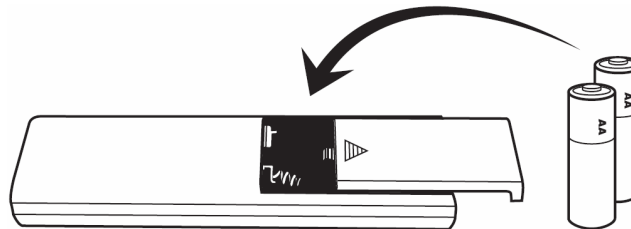

Note: Remote Control buttons correspond with the similarly labeled buttons on the main unit. The recommended distance for remote operation is 16 feet or less.

OPERATIONAL INSTRUCTIONS

Listening to the Radio

1. Slide the **FUNCTION SWITCH** to the **RADIO** position.
2. Slide the **BAND SWITCH** to the desired waveband (AM, FM or FM ST.).
3. Turn the **TUNING KNOB** to your desired radio station, radio frequency appears on the **LCD SCREEN**.
4. Adjust the sound level by pressing the **VOLUME CONTROL** knob Up or Down.
5. To turn off the radio, press the **POWER BUTTON** once. The backlight of the **LCD SCREEN** will go "off" while the **STANDBY LED INDICATOR** will light up.

FM Stereo Indicator

Slide the **BAND SWITCH** to **FM ST.** position, the FM Stereo Indicator will light up when listening to a strong station that is broadcasting in "Stereo". When the FM stereo reception is weak, slide the **BAND SWITCH** to **FM** position, in the case this reception will be monaural.

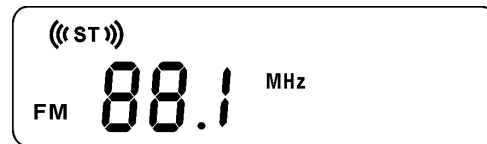

BASS BOOST

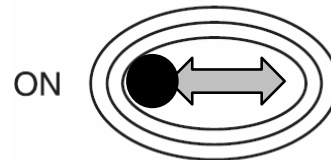

OFF

Bass Boost

To enhance the low frequency sound, slide the **BASS BOOST** switch to the **ON** position. To release the super bass, slide the **BASS BOOST** button to **OFF**.

Auxiliary (AUX) Mode

1. Slide the **FUNCTION SWITCH** to the **AUX** position.
2. Connect the earphone socket from the Auxiliary unit (e.g. MP3 player or MD player) into **AUX-IN JACK** on the rear of this product via an Audio Line Cord (3.5mm plug on both ends ; not supplied).
3. Play the Auxiliary unit. Music from the Auxiliary unit can be listened through the speaker of this product.

Playing a Compact Disc

Note: Should skipping of tracks occur during CD playing, try turning the volume down.

When CD is playing, **DO NOT** open the **CD DOOR**.

1. Open the **CD DOOR** by pressing the right-bottom corner of the **CD DOOR**. Put a CD disc into the CD Compartment and close the **CD DOOR**. Set the **FUNCTION SWITCH** to "CD" position.

Note : Ensure the **CD DOOR** is closed properly and locked in place.

2. When the **CD DOOR** is closed with a CD inside, total number of the tracks in the disc will be shown on the **LCD SCREEN** and will go to stop mode. (ex. Total 17 tracks inside the disc).



3. If there is no disc inside, the **LCD SCREEN** will show "no" and go to stop mode.



OPERATIONAL INSTRUCTIONS

Playing a Compact Disc-continued

4. If the **CD DOOR** is not closed, the **DISPLAY** will show “- - -”.



PLAY/PAUSE MODE

1. When the **PLAY/PAUSE BUTTON** is pressed during CD stop mode, the first track will be played. The Play Indicator “▶” will be shown on the **LCD SCREEN**. The **LCD SCREEN** will show the specific number of track being played.

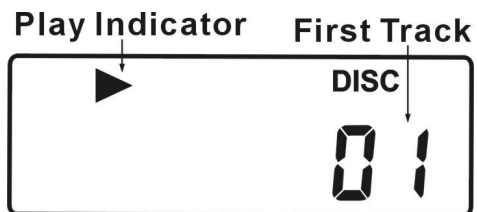

2. For interruption while the CD is playing, press the **CD PLAY/PAUSE BUTTON** once. The Play Indicator “▶” will blink continuously on the **LCD SCREEN**.

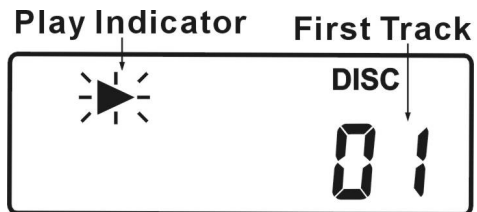

3. Though the sound stops, the disc will continue to spin. To re-start playing, press the **CD PLAY/PAUSE BUTTON** once again. The music will start from the exact position where it was interrupted.
4. To stop the CD, press the **CD STOP BUTTON** once whether the CD is in Play or Pause mode. The **LCD SCREEN** will show the total number of tracks of the disc again.
5. To turn off the unit, press the **POWER BUTTON** once.

SKIP AND SEARCH MODE

1. During play or pause mode, when **CD SKIP/SEARCH FORWARD** ►► or **BACKWARD** ◄◄ **BUTTON** is pressed once, it will go to the next track or go back to the beginning of the track.
2. During play mode, when **CD SKIP/SEARCH FORWARD** ►► or **BACKWARD** ◄◄ **BUTTON** is pressed and held, it will search the track with audible high-speed forward or backward playback.

REPEAT MODE

1. Repeat 1 :
When the **MODE BUTTON** is pressed once, the “Repeat” Indicator will be shown on the **LCD SCREEN**. This single track of music will be repeated.
2. Repeat All:
When the **MODE BUTTON** is pressed twice, the “Repeat All” Indicator will be shown on the **LCD SCREEN**. The whole disc can be played continuously.

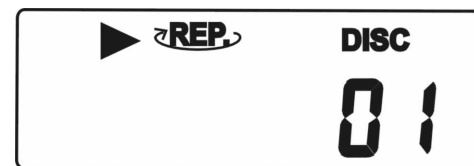
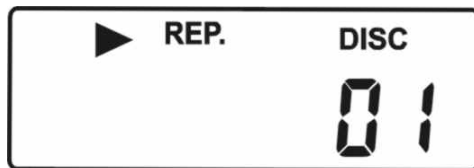

OPERATIONAL INSTRUCTIONS

Playing a Compact Disc-continued

- To cancel the Repeat Function
Press the **MODE BUTTON** repeatedly until the Repeat Indicator disappears from the **LCD SCREEN**.

RANDOM PLAY MODE

This feature allows the track on the disc to be played in a random order.

- During the CD stop mode, press the **MODE BUTTON** three times, the "RANDOM" indicator will be shown on the **LCD SCREEN**. Press the **PLAY BUTTON** once to start the playback.
- To cancel the random play function, press the **MODE BUTTON** again, "RANDOM" Indicator will disappear from the **LCD SCREEN**.

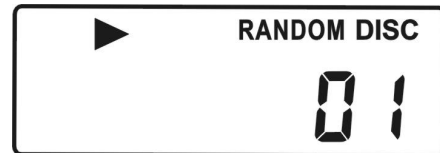

PROGRAM MODE

- During the CD stop mode, press the **PROGRAM BUTTON** once. The "PROGRAM" Indicator and the number of Program to be memorized starts from the first program "P01" will light up and blink continuously. Press the **CD SKIP/SEARCH FORWARD** or **BACKWARD** to select your desired musical track, the **LCD SCREEN** will show the appropriate track number. Press the **PROGRAM BUTTON** to store this track in memory.

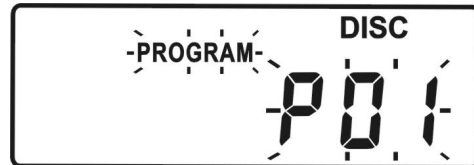

- Repeat above procedure until all desired tracks have been programmed. A total of 20 tracks can be stored in memory.

Remarks :Whenever **CD SKIP/SEARCH FORWARD** or **BACKWARD** **BUTTON** is pressed, it will always show the last programmed track first to recall your memory. After complete programming, **LCD SCREEN** will show "PROG. _ _ _" and flash continuously.



- Press the **CD PLAY/PAUSE BUTTON** once to start the program playback and the CD Play Indicator "▶" will light up.

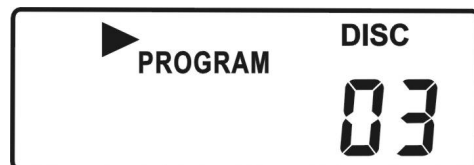

- To check the program you have stored after complete programming, press the **PROGRAM BUTTON** once during CD play mode, then press the **CD SKIP/SEARCH FORWARD** **BUTTON** step by step.

OPERATIONAL INSTRUCTIONS

Playing a Compact Disc-continued

5. To cancel the programmed memory :
 - During the CD stop mode, press the **CD STOP BUTTON** once. OR
 - Open the **CD DOOR** during the CD stop mode.
 - The "PROGRAM" Indicator will disappear from the **LCD SCREEN**.

Playing an MP3 Disc

Note: Should skipping of tracks occur during MP3 Disc playing, try turning the volume down. When MP3 disc is playing, DO NOT open the **CD DOOR**.

1. Open the **CD DOOR** by pressing the right bottom corner of the **CD DOOR**. Put a MP3 disc into the CD compartment and close the **CD DOOR**. Set the **FUNCTION SWITCH** to "CD" position.

Note : Ensure the **CD DOOR** is closed properly and locked in place.
2. When the **CD DOOR** is closed with a MP3 disc inside, total number of the tracks in the disc will be shown on the **LCD SCREEN** and go to stop mode.
3. If there is no disc inside, the **DISPLAY** will show "no" and go to stop mode.
4. If the **CD DOOR** is not closed, the **DISPLAY** will show " _ _ _".

PLAY/PAUSE MODE

1. When the **PLAY/PAUSE BUTTON** is pressed during CD stop mode, the first track will be played. The Play Indicator "▶" will be lighted. The "MP3" Indicator will be shown as well to indicate MP3 Disc is being played. The **LCD SCREEN** will show the specific track number being played.
 
2. To select the specific musical tracks inside the MP3 Disc.

MP3 music can be stored into CD Disc with or without folders according to your "MP3 burning method".

 - a. If the MP3 disc is downloaded without dividing into folder, all track number will be



shown directly in the **LCD SCREEN**. The Album number will only show 001 after pressing the **FOLDER UP** or **DOWN BUTTON**.

OPERATIONAL INSTRUCTIONS

Playing an MP3 Disc-continued

- b. If the music is stored into different folders, then you've to select the specific Album number first by pressing the **FOLDER UP** or **DOWN BUTTON** ; afterwards press the **CD SKIP/SEARCH FORWARD** or **BACKWARD BUTTON** to select the specific Track number music inside this Album.

Example : To select Album # 4, track # 3.

- STEP – 1 : Press the **FOLDER UP** or **DOWN BUTTON** to select the Album # 4.



- STEP – 2 : Press the **CD SKIP/SEARCH FORWARD** or **BACKWARD BUTTON** to select the Track # 3 inside this Album # 4.



3. For interruption while MP3 disc is playing, press the **CD PLAY/PAUSE BUTTON** once. The Play Indicator "▶" will blink continuously on the **LCD SCREEN**.
4. Though the sound stops, the disc will continue to spin. To re-start playing, press the **CD PLAY/PAUSE BUTTON** once again. The music will start from the exact position where it was interrupted.
5. To stop the MP3 disc, press the **CD STOP BUTTON** once whether the MP3 disc is in Play or Pause mode.
6. To turn off the unit, press the **POWER BUTTON** once.

REPEAT MODE

1. Repeat 1 :
When the **MODE BUTTON** is pressed once, the "REPEAT" Indicator will light. This single track of music will be repeated.
2. Repeat Folder :
When the **MODE BUTTON** is pressed twice, the "REPEAT and ALBUM" indicators will be shown. This specific folder will be played repeatedly.
3. Repeat All :
When the **REPEAT BUTTON** is pressed three times, the "REPEAT ALL" Indicator will be shown. The whole disc can be played continuously.
4. To cancel the Repeat Function
Press the **MODE BUTTON** repeatedly until the Repeat Indicator disappears from the **LCD SCREEN**.



OPERATIONAL INSTRUCTIONS

Playing an MP3 Disc-continued

RANDOM PLAY MODE

This feature allows the tracks on the disc to be played in a random order.

1. During the CD Stop mode, press the **MODE BUTTON** four times, the “**RANDOM**” Indicator will show on the LCD DISPLAY. Press the **PLAY/PAUSE BUTTON** once to start the playback.
2. To cancel the Random Play function, press the **MODE BUTTON** again, “**RANDOM**” Indicator will disappear from the **LCD SCREEN**.



SKIP AND SEARCH MODE

1. During play or pause mode, when **CD SKIP/SEARCH FORWARD** **▶▶** or **BACKWARD** **◀◀** **BUTTON** is pressed once, it will go to the next track or go back to the beginning of the track.
2. During play mode, when **CD SKIP/SEARCH FORWARD** **▶▶** or **BACKWARD** **◀◀** **BUTTON** is pressed once and held, it will search the track with audible high speed forward or backward playback.

PROGRAM MODE

1. During the CD stop mode, press the **PROGRAM BUTTON** once. The “PROGRAM” Indicator and the number of Program to be memorized starts from the first program “**001**” will light up and blink continuously. Press the **FOLDER UP** or **DOWN BUTTON**, then press **CD SKIP/SEARCH FORWARD** or **BACKWARD BUTTON** to select your desired musical track, **LCD SCREEN** will show the track number of this specific Album to be programmed. Press the **PROGRAM BUTTON** to store this track in memory.
2. Repeat above procedure until all desired tracks have been programmed.

Remarks : Whenever the **FOLDER UP** or **DOWN BUTTON** is pressed, it will always show the last programmed Album number first to recall your memory.

A total of 20 tracks can be stored in memory. After complete programming, LCD DISPLAY will show “**PROG. _ _ _**” and blink continuously.

3. To start the Programmed playback, press the **CD PLAY/PAUSE BUTTON** once and the CD Play Indicator “▶”, “PROGRAM”, “MP3” Indicator and the track number of the specific Album will light up.

Example : Album # 3, Track # 2.

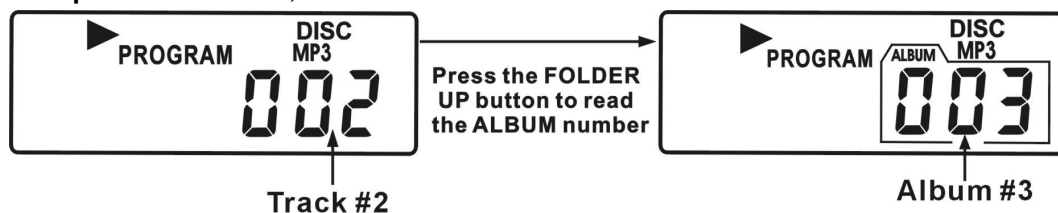

4. To check the program you have stored after complete programming, press the **CD SKIP/SEARCH FORWARD BUTTON** step by step during CD program play mode, track number of the Album will be shown. Press the **FOLDER UP** or **DOWN BUTTON** to read the Album number.
5. To cancel the programmed memory :
 - During the CD stop mode, press the **CD STOP BUTTON** once. Or,
 - Open the CD Door during the CD stop mode.
 The “PROGRAM” Indicator will disappear from the **LCD SCREEN**.

MAINTENANCE

Notes on CDs

1. Before playing, clean the CD with a cleaning cloth. Wipe the CD from the center out to the ends.
2. Do not use solvents such as benzine, thinner, commercially available cleaners or anti-static spray intended for vinyl LPs.
3. Do not expose the CD to direct sunlight or heat sources such as hot air ducts. Do not expose to direct sunlight, nor leave CDs in a car, as there can be a considerable rise in temperature.
4. Do not stick paper or sticker on the CD. Do not scratch, dirt or fingerprints on the CD, for it may cause tracking error.

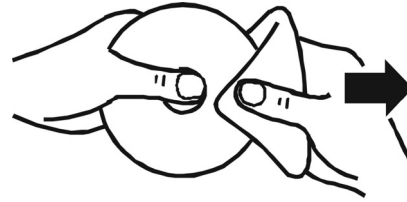

Cleaning the lens

If the lens becomes dirty, it may cause a skipping of sound during CD operation. Clean with a commercially available lens cleaner.

Cleaning the cabinet

Clean the cabinet, panel and controls with a soft cloth slightly moistened with a mild detergent solution. Do not use any type of abrasive pad, scouring powder, or solvent, such as alcohol or benzine.

TROUBLESHOOTING GUIDE

When the instructions in this manual are followed, this unit should function properly. However, if any of the following difficulties occur and cannot be corrected by the user or if a problem arises that is not mentioned here, please contact jWIN Customer Service or a qualified service technician.

1. Unit Does Not Play
 - Unit may be disconnected from power source. Check connection.
 - Disc is not correctly set. CDs should be inserted label side up.
 - Disc is scratched or dirty. Please clean.
 - The lens is dirty. Wipe clean gently with soft, dry cloth. Follow the instructions of the lens cleaner.
 - There is moisture on the lens wait an hour and try again.
2. No Sound, Distorted Sound or Feedback
 - Ensure plugs are inserted firmly.
 - Wipe off plugs with clean cloth.
 - Disc is scratched or dirty. Please clean.
 - Volume control is turned down. Please increase.
3. Sound from Only One Side (or inverted)
 - Speaker cords are not properly connected.
 - Input cords are not properly connected.
4. Radio Reception is Unclear
 - Radio station frequency may be weak. Adjust antenna.
 - If FM station, **BAND** switch may be set to **FM ST**. Slide **BAND** switch to **FM**.

SPECIFICATIONS

- Audio Output: $2W_{RMS}$ per channel
Total: $4W_{RMS}$ / $8W_{RMS}$ / $80W_{PMPO}$
- Connectivity
 - Satellite speaker terminals (L / R)
 - 3.5mm headphone jack
 - 3.5mm stereo headphone jack
- Power Requirement
 - JX-CD2100: AC 120V, 60Hz (USA, Canada)
 - Remote Control: 3V (2 x "AAA" batteries, not included)
- Unit Dimensions (W x H x D)
 - Main Unit: Approx. 14.9" x 7.6" x 11.2" (378mm x 193mm x 284mm)
 - Satellite Speakers: Approx. 4.6" x 5.7" x 6.5" (117mm x 145mm x 165mm) per speaker
- Unit Weight
 - Main Unit: Approx. 5.68 lbs (2.6 kg)
 - Satellite speakers: Approx. 3.28 lbs (1.49 kg) per speaker

* Specifications and features are subject to change without prior notice.

jWIN

TEL: 516-626-7188

FAX: 516-626-7105

website: www.jWIN.com

© 2007 jWIN Electronics Corp. All rights reserved. No portion of this printed material or product enclosed herewith including design, shape and graphics, may be reproduced or transmitted in any form without prior written consent of jWIN Electronics Corp. by any means, electronic or mechanical, including photocopying, recording or use of an information storage and retrieval system. Any unauthorized distribution or reproduction of this printed material or product, or any portion thereof, will be prosecuted to the fullest possible extent of the law.

Printed in China