

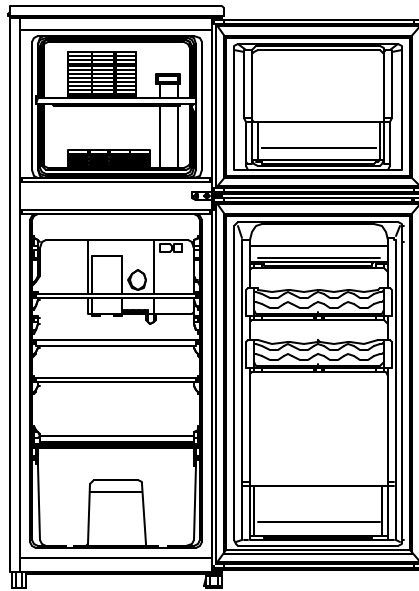

**DELUXE FROST FREE
INSTRUCTION MANUAL
MANUAL DE INSTRUCCIONS**

Model Numbers / No. de Modelos : FF511W / FF512PS

**REFRIGERATOR-FREEZER
REFRIGERADOR-CONGELADOR**



BEFORE USE, PLEASE READ AND FOLLOW ALL SAFETY RULES AND OPERATING INSTRUCTIONS.

La sección en español empieza en la página 18.

Avanti has a policy of continuous improvement on its products and reserves the right to change materials and specifications without notice.

Avanti Products, A Division of The Mackle Co., Inc.
P.O. Box 520604- Miami, Florida 33152
www.avantiproducts.com

REFRIGERATOR SAFETY

Your safety and the safety of others are very important.

We have provided many important safety messages in this manual for your appliance. Always read and obey all safety messages.



This is the Safety Alert Symbol. This symbol alerts you to potential hazards that can kill or injure you and others. All safety messages will follow the Safety Alert Symbol and either the words "DANGER", "WARNING" or "CAUTION".



Danger means that failure to heed this safety statement may result in severe personal injury or death.



Warning means that failure to heed this safety statement may result in extensive product damage, serious personal injury, or death.



Caution means that failure to heed this safety statement may result in minor or moderate personal injury, property or equipment damage.

All safety messages will alert you to know what potential hazard is, tell you how to reduce the chance of injury, and let you know what can happen if the instructions are not followed.

IMPORTANT SAFEGUIDES



Before the refrigerator is used, it must be properly positioned and installed as described in this manual, so read the manual carefully. To reduce the risk of fire, electrical shock or injury when using the refrigerator, follow basic precaution, including the following:

DANGER

- ? Plug into a grounded 3-prong outlet, do not remove grounding prong, do not use an adapter, and do not use an extension cord.
- ? It is recommended that a separate circuit, serving only your refrigerator be provided. Use receptacles that cannot be turned off by a switch or pull chain.
- ? Never clean refrigerator parts with flammable fluids. These fumes can create a fire hazard or explosion. And do not store or use gasoline or other flammable vapors and liquids in the vicinity of this or any other appliance. The fumes can create a fire hazard or explosion.
- ? Before proceeding with cleaning and maintenance operations, make sure the power line of the unit is disconnected.
- ? Do not connect or disconnect the electric plug when your hands are wet.
- ? Unplug the refrigerator or disconnect power before cleaning or servicing. Failure to do so can result in electrical shock or death.
- ? Do not attempt to repair or replace any part of your refrigerator unless it is specifically recommended in this manual. All other servicing should be referred to a qualified technician.

WARNING

FOLLOW WARNING CALL OUTS BELOW ONLY WHEN APPLICABLE TO YOUR MODEL

- ? Use two or more people to move and install refrigerator. Failure to do so can result in back or other injury.
- ? To ensure proper ventilation for your refrigerator, the front of the unit must be completely unobstructed. Choose a well-ventilated area with temperatures above 60°F (16°C) and below 90°F (32°C). This unit must be installed in an area protected from the element, such as wind, rain, water spray or drips.
- ? The refrigerator should not be located next to ovens, grills or other sources of high heat.
- ? The refrigerator must be installed with all electrical, water and drain connections in accordance with state and local codes. A standard electrical supply (115 V AC only, 60 Hz), properly grounded in accordance with the National Electrical Code and local codes and ordinances is required.
- ? Do not kink or pinch the power supply cord of refrigerator.
- ? The fuse (or circuit breaker) size should be 15 amperes.
- ? It is important for the refrigerator to be leveled in order to work properly. You may need to make several adjustments to level it.
- ? All installation must be in accordance with local plumbing code requirements.
- ? Make certain that the pipes are not pinched or kinked or damaged during installations.
- ? Check for leaks after connection.
- ? Never allow children to operate, play with or crawl inside the refrigerator.
- ? If you use the drainage container, you MUST set the Drain Select switch to OFF or the water can overflow from the drainage container
- ? Although the unit has been tested at the factory, due to long-term transit and storage, the first batch of cubes must be discarded.
- ? Do not use solvent-based cleaning agents or abrasives on the interior. These cleaners may damage or discolor the interior.
- ? Do not use this apparatus for other than its intended purpose.

REGISTRATION INFORMATION

Thank you for purchasing this fine Avanti product. Please fill out this form and return it within 100 days from the date of purchase and receive these important benefits to the following address:

**Avanti Products, A Division of The Mackle Co., Inc.
P.O.Box 520604 – Miami, Florida 33152**

✂ **Protect your product:**

We will keep the model number and date of purchase of your new Avanti product on file to help you refer to this information in the event of an insurance claim such as fire or theft.

✂ **Promote better products:**

We value your input. Your responses will help us develop products designed to best meet your future needs.

----- (detach here) -----

Avanti Registration Form

Name

Model # Serial #

Address

Date Purchased Store/Dealer Name

City State Zip

Occupation

Area Code Phone Number

As Your Primary Residence, Do You:

? Own ? Rent

Did You Purchase An Additional Warranty:

? Extended ? Food Loss ? None

Your Age:

? under 18 ? 18-25 ? 26-30

Reason For Choosing This Avanti Product:

Please indicate the most important factors that influenced your decision to purchase this product.

? 31-35 ? 36-50 ? over 50

Marital Status:

? Married ? Single

? Price

Is This Product Used In The:

? Home ? Business

? Product Features

How Did You Learn About This Product:

? Avanti Reputation

? Advertising ? Personal Demo

? Product Quality

? In Store Demo

? Salesperson Recommendation

? Other _____

? Friend/Relative Recommendation

Comments _____

? Warranty

? Other _____

HELP US HELP YOU...

Read this guide carefully.

It is intended to help you operate and maintain your new refrigerator-freezer properly.

Keep it handy to answer your questions. If you don't understand something or you need more assistance, please call:

**Avanti Customer Service
800-220-5570**

Keep proof of original purchase date (such as your sales slip) with this guide to establish the warranty period.

CAUTION:

THIS REFRIGERATOR-FREEZER IS NOT DESIGNED FOR THE STORAGE OF MEDICINE OR OTHER MEDICAL PRODUCTS.

Write down the model and serial numbers.

You'll find them on a plate located on the rear wall of the refrigerator-freezer.

Please write these numbers here:

Date of Purchase

Model Number

Serial Number

Use these numbers in any correspondence or service calls concerning your refrigerator-freezer.

If you received a damaged refrigerator-freezer, immediately contact the dealer (or builder) that sold you the refrigerator-freezer.

Save time and money. Before you call for service, check the Troubleshooting Guide. It lists causes of minor operating problems that you can correct yourself.

IF YOU NEED SERVICE

We're proud of our service and want you to be pleased. If for some reason you are not happy with the service you receive, here are some steps to follow for further assistance.

FIRST, contact the people who serviced your refrigerator-freezer. Explain why you are not satisfied. In most cases, this will solve the problem.

NEXT, if you are still not pleased, write all the details, including your telephone number, and send it to:

**Customer Service
Avanti Products
10880 NW 30 Street
Miami, FL 33172**

PARTS AND FEATURES

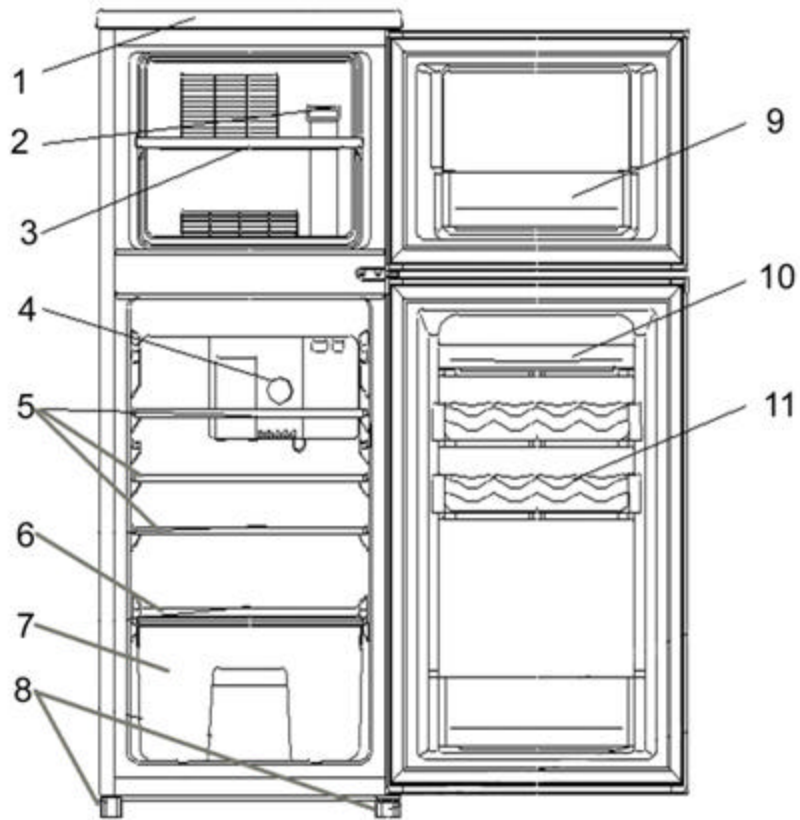

1. TOP COVER
2. FREEZER TEMPERATURE CONTROL SELECTOR
3. FREEZER SHELF
4. REFRIGERATOR TEMPERATURE CONTROL KNOB
5. REFRIGERATOR SHELVES
6. CRISPER COVER
7. CRISPER
8. LEVELING LEGS
9. FREEZER DOOR RACK
10. REFRIGERATOR DOOR RACKS
11. CAN DISPENSER

TABLE OF CONTENTS

REFRIGERATOR SAFETY _____	2
IMPORTANT SAFEGUIDES _____	3
REGISTRATION INFORMATION _____	4
HELP US HELP YOU ... _____	6
PARTS AND FEATURES _____	7
IMPORTANT SAFETY INSTRUCTIONS _____	9
INSTALLATION INSTRUCTIONS _____	9
BEFORE USING YOUR APLIANCE _____	9
INSTALLATION OF YOUR APPLIANCE _____	9
ELECTRICAL CONNECTION _____	10
EXTENSION CORD _____	10
REVERSING THE DOOR SWING OF YOUR APPLAINCE _____	10
OPERATING YOUR APPLIANCE _____	11
TEMPERATURE CONTROL PANELS _____	11
SETTING THE TEMPERATURE CONTROL _____	11
USING YOUR ICE CUBE TRAY _____	11
FREEZING FRSH FOODS _____	11
CARE AND MAINTENANCE _____	12
CLEANING YOUR APPLIANCE _____	12
POWER FAILURE _____	12
VACATION TIME _____	12
MOVING YOUR APPLIANCE _____	12
ENERGY SAVING TIPS _____	13
REPLACING YOUR LIGHT BULB _____	13
TROUBLESHOOTING GUIDE _____	14
SERVICE FOR YOUR APPLIANCE _____	15
YOUR AVANTI PRODUCTS WARRANTY _____	16
WIRING DIAGRAM _____	17
INSTRUCCIONES EN ESPAÑOL _____	18~22

IMPORTANT SAFETY INSTRUCTIONS

 WARNING	To reduce the risk of fire, electrical shock, or injury when using your refrigerator-freezer, follow these basic precautions:
<ul style="list-style-type: none">? Read all instructions before using the refrigerator-freezer.? DANGER or WARNING: Risk of child entrapment. Child entrapment and suffocation are not problems of the past. Junked or abandoned refrigerator-freezers are still dangerous. . . even if they will “just sit in the garage a few days.”? Before you throw away your old refrigerator-freezer: Take off the doors. Leave the shelves in place so that children may not easily climb inside.? Never allow children to operate, play with, or crawl inside the refrigerator-freezer.? Never clean refrigerator-freezer parts with flammable fluids. The fumes can create a fire hazard or explosion.? Do not store or use gasoline or any other flammable vapors and liquids in the vicinity of this or any other refrigerator-freezer. The fumes can create a fire hazard or explosion. <p style="text-align: center;">-Save these instructions-</p>	

INSTALLATION INSTRUCTIONS

Before Using Your Appliance

- ? Remove the exterior and interior packing.
- ? Check to be sure you have all of the following parts:
 - ? 1 Ice Cube Tray
 - ? 2 Refrigerator Shelves
 - ? 1 Freezer Shelf
 - ? 1 Instruction Manual
- ? Before connecting the refrigerator-freezer to the power source, let it stand upright for approximately 2 hours. This will reduce the possibility of a malfunction in the cooling system from handling during transportation.
- ? Clean the interior surface with lukewarm water using a soft cloth.

Installation of Your Appliance

- ? Place your refrigerator-freezer on a floor that is strong enough to support the refrigerator-freezer when it is fully loaded. To level your refrigerator-freezer, adjust the leveling legs at the bottom of refrigerator-freezer.
- ? Allow 2 inches of space between the back and sides of the refrigerator-freezer, which allows the proper air circulation to cool the compressor and condenser.
- ? Locate the refrigerator-freezer away from direct sunlight and sources of heat (stove, heater, radiator, etc.). Direct sunlight may affect the acrylic coating and heat sources may increase electrical consumption. Extreme cold ambient temperatures may also cause the refrigerator-freezer not to perform properly.
- ? Avoid locating the refrigerator-freezer in moist areas.
- ? Plug the refrigerator-freezer into an exclusive properly installed-grounded wall outlet. Do not under any circumstances cut or remove the third (ground) prong from the power cord. Any questions concerning power and/or grounding should be directed toward a certified electrician or an authorized Avanti Products service center.

[Electrical Connection](#)

Warning

Improper use of the grounded plug can result in the risk of electrical shock. If the power cord is damaged, have it replaced by an authorized Avanti Products service center.

This unit should be properly grounded for your safety. The power cord of this unit is equipped with a three-prong plug which mates with standard three prong wall outlets to minimize the possibility of electrical shock.

Do not under any circumstances cut or remove the third ground prong from the power cord supplied. For personal safety, this appliance must be properly grounded.

This unit requires a standard 115/120 Volt AC ~/60Hz electrical outlet with three-prong ground. Have the wall outlet and circuit checked by a qualified electrician to make sure the outlet is properly grounded. When a standard 2-prong wall outlet is encountered, it is your responsibility and obligation to have it replaced with a properly grounded 3-prong wall outlet.

The cord should be secured behind the unit and not left exposed or dangling to prevent accidental injury.

The unit should always be plugged into its own individual electrical outlet which has a voltage rating that matches the rating label on the appliance. This provides the best performance and also prevent overloading house wiring circuits that could cause a fire hazard from overheated. Never unplug the unit by pulling the power cord. Always grip the plug firmly and pull straight out from the receptacle. Repair or replace immediately all power cords that have become frayed or otherwise damaged. Do not use a cord that shows cracks or abrasion damage along its length or at either end. When moving the unit, be careful not to damage the power cord.

[Extension Cord](#)

Because of potential safety hazards under certain conditions, it is strongly recommended that you do not use an extension cord with this unit. However, if you must use an extension cord it is absolutely necessary that it be a UL/CUL-Listed, 3-wire grounding type appliance extension cord having a grounding type plug and outlet and that the electrical rating of the cord be 115 volts and at least 10 amperes.

[Reversing the Door Swing of Your Appliance](#)

This refrigerator-freezer has the capability of the door opening from either the left or right side. The unit is delivered to you with the door opening from the left side. Should you desire to reverse the opening direction, please call service for reversal instructions.

OPERATING YOUR APPLIANCE

✦ Temperature Control Panels

Refrigerator Temperature Control

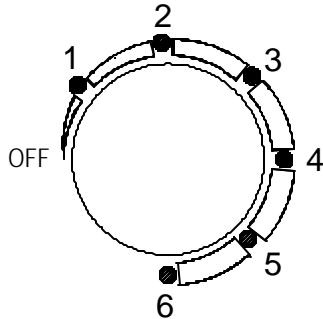

Freezer Temperature Control

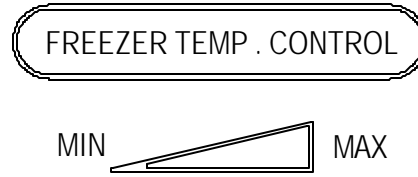

✦ Setting the Temperature Control

- ? To control the internal temperature, adjust the control dial according to the ambient temperature or purpose of use.
- ? The first time you turn the unit on, set the temperature control to “6” in refrigerator section and “MAX” in freezer section.
- ? The range of the temperature control is from position “1” the warmest to “6” the coldest in refrigerator section and from position “MIN” the warmest to “MAX” the coldest. After 24 to 48 hours, adjust the temperature control to the setting that best suits your needs. The setting of “3” in refrigerator section and middle of “MIN” and “MAX” in freezer section should be correct for home or office refrigerator use.

NOTE:

- ✦ IF THE UNIT IS UNPLUGGED, HAS LOST POWER, OR IS TURNED OFF, YOU MUST WAIT 3 TO 5 MINUTES BEFORE RESTARTING THE UNIT. IF YOU ATTEMPT TO RESTART BEFORE THIS TIME DELAY, THE REFRIGERATOR-FREEZER WILL NOT START.
- ✦ TURNING THE TEMPERATURE CONTROL TO “OFF” POSITION STOPS THE COOLING CYCLE BUT DOES NOT SHUT OFF THE POWER TO THE UNIT.

✦ Using Your Ice Cube Tray

- ? Recommended thermostat setting for ice making is position “MAX” .
- ? Fill the ice cube tray (twothirds of it) with cold water or with any liquid suitable for freezing and place the tray on the bottom of the freezer to freeze properly.
- ? Dry the tray, otherwise it may stick to the bottom of the freezer.
- ? The best method to get ice cubes out of the tray is to hold the tray under cold tap water for a second.
- ? To eject the ice cubes from the tray, place over the ice bucket and twist slightly



✦ Freezing Fresh Foods

- ? Proper use of the appliance, adequately packed food, correct temperature and taking into account hygienic precautions will substantially influence the quality of freezing the food or storing of the

frozen foods.

- ? This compartment is designed for the long-term storage of frozen food.
- ? The storage life of frozen foods varies and the recommended storage time should not be exceeded.
- ? Pre-packed commercially frozen food should be stored in accordance with the frozen foods manufacturer's instructions for a three star frozen food storage compartment or home freezer.
- ? Place frozen food into the freezer as quickly as possible after purchase. If there are instructions on the packet, carefully follow these instructions regarding storage times.
- ? Carefully select food you intend to freeze, it should be of adequate quality and suitable for freezing.
- ? Use correct packaging and wrap it tight.
- ? The packaging should be airtight and shouldn't leak since this could cause substantial vitamin loss and dehydration of foods.
- ? Foils and bags should be soft enough to tightly wrap around the foods.
- ? When preparing foods to be frozen, consider sanitary precautions.
- ? Mark packages with following data: kind and amount of foods and the date of loading.
- ? It is most important that the food is frozen as quickly as possible.
- ? If the loading amount is too large, the quality of freezing is reduced which affects the quality of frozen foods.

CARE AND MAINTENANCE

Cleaning Your Appliance

- ? Turn the temperature control to "OFF", unplug the unit, and remove the food and baskets.
- ? Wash the inside with a warm water and baking soda solution. The solution should be about 2 tablespoons of baking soda to a quart of water.
- ? Wash the baskets with a mild detergent solution.
- ? The outside of the unit should be cleaned with mild detergent and warm water.

CAUTION

Failure to unplug the refrigerator-freezer could result in electrical shock or personal injury.

Power Failure

Most power failures are corrected within a few hours and should not affect the temperature of your refrigerator-freezer if you minimize the number of times the door is opened. If the power is going to be off for a longer period of time, you need to take the proper steps to protect your food.

Vacation Time

Short vacations: Leave the unit operating during vacations of less than three weeks.

Long vacations: If the appliance will not be used for several months, remove all food and unplug the power cord. Clean and dry the interior thoroughly. To prevent odor and mold growth, leave the door open slightly: blocking it open if necessary

Moving Your Appliance

- ? Remove all the food.
- ? Securely tape down all loose items inside your unit.
- ? Turn the leveling screws up to the base to avoid damage.
- ? Tape the door shut.
- ? Be sure the unit stays in the upright position during transportation.

✍ **Energy Saving Tips**

- ? The unit should be located in the coolest area of the room, away from heat producing appliances or heating ducts, and out of the direct sunlight.
- ? Let hot foods cool to room temperature before placing them in the unit. Overloading the unit forces the compressor to run longer. Foods that freeze too slowly may lose quality, or spoil.
- ? Be sure to wrap foods properly, and wipe containers dry before placing them in the unit. This cuts down on frost build-up inside the freezer.
- ? Organize and label food to reduce door openings and extended searches. Remove as many items as needed at one time, and close the door as soon as possible.

✍ **Replacing Your Light Bulb**

- ? Unplug the AC power cord from the wall.
- ? Push up the tab underneath the lamp cover.
- ? Pull down to remove lamp cover.
- ? Remove the light bulb.
- ? Replace the light bulb with a similar size (10W).
- ? Fit the lamp cover on.

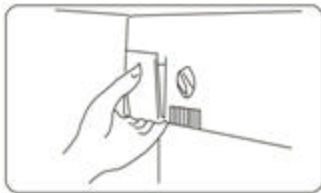

PROBLEMS WITH YOUR APPLIANCE ?

You can solve many common refrigerator-freezer problems easily, saving you the cost of a possible service call. Try the suggestions below to see if you can solve the problem before calling the service.

TROUBLESHOOTING GUIDE

PROBLEM	POSSIBLE CAUSE
Unit does not operate.	Not plugged in. The circuit breaker tripped or a blown fuse. The refrigerator-freezer temperature control is set at "OFF".
Compressor turns on and off frequently.	The room temperature is hotter than normal. A large amount of food has been added to the refrigerator - freezer. The door is opened too often. The door is not closed completely. The temperature control is not set correctly. The door gasket does not seal properly. The refrigerator -freezer does not have the correct clearances.
Vibrations.	Check to assure that the refrigerator - freezer is level.
The unit seems to make too much noise.	The rattling noise may come from the flow of the refrigerant, which is normal. As each cycle ends, you may hear gurgling sounds caused by the flow of refrigerant in your refrigerator - freezer. Contraction and expansion of the inside walls may cause popping and crackling noises. The unit is not level.
The door will not close properly.	The unit is not level. The door is reversed and not properly installed. The gasket is dirty. The baskets are out of position.

SERVICE FOR YOUR APPLIANCE

We are proud of our customer service organization and the network of professional service technicians that provide service on your Avanti refrigerator - freezer. With the purchase of your Avanti refrigerator - freezer, you can be confident that if you ever need additional information or assistance, the Avanti Products Customer Service team will be here for you. Just call us toll-free.

AVANTI PRODUCTS CUSTOMER SERVICES

Product Information 800-323-5029	Whatever your questions are about our products, help is available.
Part Orders 800-220-5570	You may order parts and accessories that will be delivered directly to your home using personal check, money order, Master Card, or Visa.
In-Home Repair Service 800-220-5570	An Avanti Products authorized service center will provide expert repair service, scheduled at a time that is convenient for you. Our trained services know your refrigerator-freezer inside and out.

YOUR AVANTI PRODUCTS WARRANTY	Staple your sales receipt here. Proof of original purchase date is needed to obtain service under warranty.
--	--

WHAT IS COVERED

**LIMITED ONE-YEAR
WARRANTY**

For one year from the date of purchase by the original owner, Avanti Products will, at its option, repair or replace any part of the refrigerator - freezer which proves to be defective in material or workmanship under normal use. During this period Avanti Products will provide all parts and labor necessary to correct such defects free of charge, so long as the refrigerator - freezer has been installed and operated in accordance with the written instructions in this manual. In rental or commercial use, the warranty period is 90 days. All Avanti appliances of 3.5 cubic feet capacity or less must be brought/sent to the appliance service shop for repair.

**LIMITED SECOND THROUGH
FIFTH YEAR WARRANTY**

For the second through the fifth year from date of original purchase, Avanti Products will provide a replacement compressor free of charge due to a failure. You are responsible for the service labor and freight charges. In rental or commercial use, the limited compressor warranty is one year and nine months. Cost to move the refrigerator - freezer to the services' shop and back to the user's home, as may be required, are the user's responsibility.

WHAT IS NOT COVERED

- ? Content losses of food due to spoilage.
- ? Incidental or consequential damages.
- ? Parts and labor costs for the following will not be considered as warranty:
- ? Evaporator doors, door springs, and/or frames.
- ? Inner door panels, door shelves, door rails, and/or door supports.
- ? Chest freezer lid liners.
- ? Vegetable crispers.
- ? Light bulbs and/or plastic housing.
- ? Plastic cabinet liners.
- ? Punctured evaporator that voids the warranty on the complete sealed system.
- ? Repairs performed by unauthorized servicers.
- ? Service calls that do not involve defects in material or workmanship such as customer education, door reversal, or proper installation.
- ? Service calls that are related to external problems, such as abuse, misuse, inadequate electrical power, accidents, fire, floods, or acts of God.
- ? Replacement of house fuses or resetting circuit breakers.
- ? Failure of the product if it is used for other than its intended purpose.
- ? This warranty does not apply outside the Continental U.S.A.

WIRING DIAGRAM

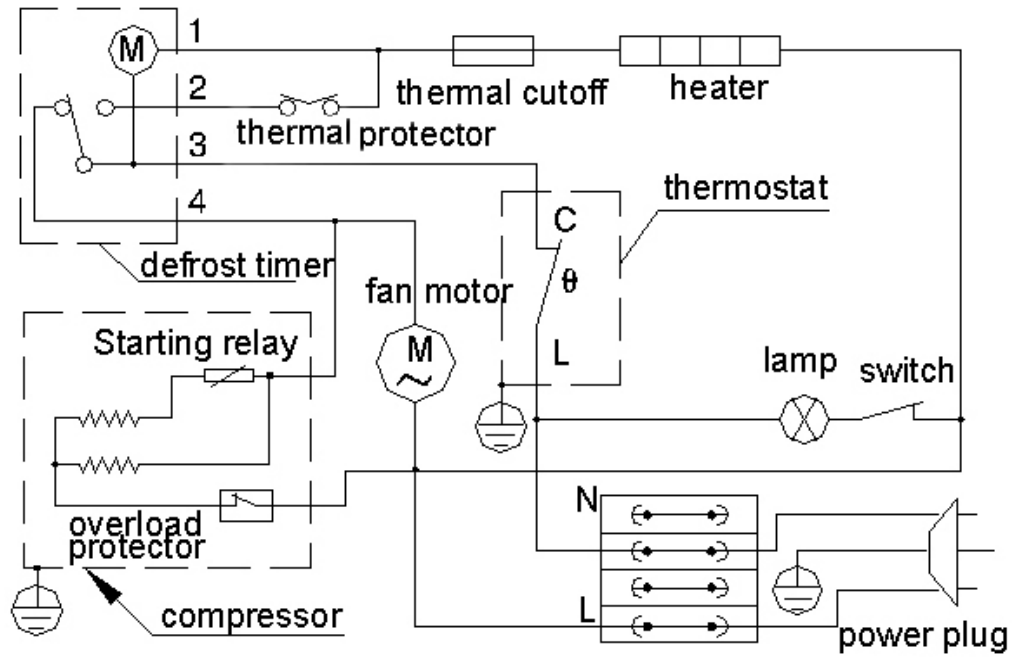

INSTRUCCIONES EN ESPAÑOL

PRECAUCIÓN	Para reducir el riesgo de incendio, descarga eléctrica, o daño cuando use su electrodoméstico, siga las siguientes precauciones.
<ul style="list-style-type: none">? Lea todas las instrucciones antes de usar su electrodoméstico.? Peligro o Precaución: Existe el riesgo que los niños queden atrapados.? Niños atrapados o sofocamiento no son un problema del pasado. Los electrodomésticos son peligrosos aún si solo los deja en el garaje por un par de días.? Antes de desechar su electrodoméstico o refrigerador usado: quítele las puertas. Deje las repisas en su lugar para evitar que los niños se queden atrapados.? No permita que los niños manejen, jueguen o entren dentro del electrodoméstico.? No limpie su electrodoméstico con líquidos inflamables. Los gases pueden ocasionar fuego o una explosión.? No guarde ni use gasolina u otros líquidos inflamables cerca de este o de cualquier otro electrodoméstico. Los vapores pueden ocasionar fuego o explosión. <p style="text-align: center;">- <u>Guarde estas instrucciones</u> -</p>	

INSTRUCCIONES PARA LA INSTALACIÓN

Antes de usar su equipo

- ? Retire la envoltura interna y externa.
- ? Verifique que tenga las siguientes partes: 1 manual de instrucciones y 3 parillas en el refrigerador, 1 parilla en el congelador y una cubetera de hielo.
- ? Antes de conectar su electrodoméstico a la corriente eléctrica, ubíquelo en una superficie plana por lo menos por 2 horas. Esto reducirá la posibilidad de malfuncionamiento en el sistema de enfriamiento por el manipuleo durante el transporte.
- ? Limpie la superficie interior con agua tibia usando un trapo suave.

Instalación de su electrodoméstico

- ? Ubique su electrodoméstico en un piso que sea lo suficientemente fuerte para soportar su peso cuando este totalmente lleno o cargado. Para nivelar el electrodoméstico, ajuste las patas delanteras.
- ? Deje aproximadamente 2 pulgadas de espacio entre la parte trasera y los costados de su electrodoméstico, así permitirá la circulación de aire necesaria para enfriar el compresor.
- ? Mantenga su electrodoméstico alejado del aire caliente, vapor o líquidos que puedan salpicarlo, ya que la unidad podría averiarse.
- ? Los rayos solares directos pueden malograr la capa acrílica, y las fuentes de calor pueden ocasionar un aumento en el consumo eléctrico. Manténgalo lo más alejado posible del agua para prevenir algún choque eléctrico. Evite los sitios húmedos y los ambientes extremadamente fríos ya que esto puede afectar la eficiencia del enfriamiento de su electrodoméstico.
- ⚡ Evite ubicar su electrodoméstico en áreas mojadas o muy húmedas.
- ? Conecte el electrodoméstico a un enchufe de pared exclusivo e instale el cable de tierra. Bajo ninguna razón se debe retirar la tercera punta del enchufe. Cualquier consulta con respecto a la energía y/o cable de tierra debe ser dirigida a un electricista certificado o autorizado por el Servicio Técnico de Avanti Products.

Conexión eléctrica

Este electrodoméstico debe ser conectado a tierra. En el caso que ocurra un corto circuito, la conexión a tierra reduce el riesgo de recibir un choque eléctrico ya que cuenta con un alambre para el escape de la corriente eléctrica. Este electrodoméstico está equipado con un enchufe que consta de tres puntas, la tercera punta es la conexión a tierra. Este enchufe debe ser insertado a un enchufe de pared que este correctamente instalado con la conexión a tierra.

ADVERTENCIA

? El uso inapropiado del enchufe a tierra puede desencadenar un choque eléctrico. Consulte a personal autorizado por Avanti Products si tiene alguna duda sobre las instrucciones o si tiene alguna consulta si el electrodoméstico está correctamente instalado a la corriente eléctrica y a tierra. Si el cordón del enchufe del electrodoméstico se encuentra dañado, debe ser reemplazado por el Servicio Técnico de Avanti Products.

- ? El cordón del enchufe está equipado con tres puntas que encajan perfectamente en un enchufe de pared standard para reducir el riesgo de un choque eléctrico.
- ? Bajo ninguna circunstancia corte o saque la tercera punta del enchufe que le proveemos ya que este es para que vaya conectado a tierra.
- ? No use una extensión.
- ? La corriente de este electrodoméstico es de 115/120 voltios, tiene una salida eléctrica de 60 hz. y consta de un enchufe de tres puntas que va conectado al enchufe de pared.
- ? El cordón del enchufe debe ser asegurado atrás del electrodoméstico y no dejarlo expuesto para evitar accidentes.

COMO CAMBIAR LA DIRECCION DE APERTURA DE LA PUERTA

En caso de que necesite cambiar el lado de apertura de la puerta, por favor consulte al servicio pos-venta de su localidad.

ADVERTENCIA

No use agua hirviendo porque dañará las partes de plástico.

- ? Retire los alimentos del electrodoméstico y colóquelos en una caja térmica para conservarlos y protegerlos.

Refrigerator Temperature Control

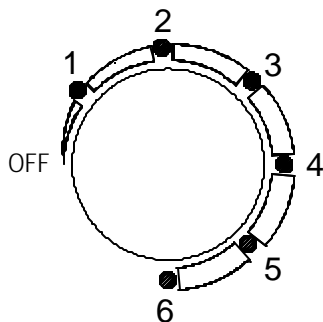

Freezer Temperature Control

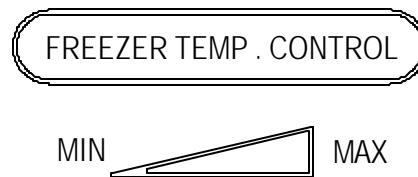

OPERACION

Para evitar vibraciones, la caja debe estar bien nivelada. Para encender el refrigerador, gire el control de temperatura a la posición que corresponda al enfriamiento deseado. Bajo condiciones normales mueva los controles a la posición "3". De otra manera ajuste la temperatura siguiendo las indicaciones señaladas en el gráfico de arriba.

USO DE LA CUBETERA DE HIELO

- ? Llene la bandeja de cubitos de hielo con agua hasta el nivel señalado ($\frac{3}{4}$ de la altura) y colóquela en el espacio designado.
- ? Asegúrese que la cubetera de guardar los cubitos de hielo esté situada debajo de la bandeja.
- ? Espere a que se formen los cubitos de hielos.

Nota: Para obtener hielos se recomienda que Ud. espere una hora como mínimo en la posición del congelador en temperatura (MAX).

CUIDADOS EN LOS PERIODOS DE AUSENCIA

- ? Para cortos períodos de ausencia (menos de 21 días) el congelador podrá quedar funcionando. Coloque el botón de control de temperaturas en la posición mínima.
- ? En períodos de ausencia más largos, se aconseja dejar el refrigerador limpio y desconectado.
- ? Retire todo lo que tenga adentro del refrigerador y haga el deshielo y la limpieza general. También retire las cubeteras, limpie bien y séquelas internamente.
- ? Deje la puerta entreabierta para penetre el aire y así evitar la formación de olores.

Compartimiento de su congelador

- ? Este compartimiento está diseñado para un período largo (3 meses) de almacenamiento de alimentos congelados.
- ? El tiempo de almacenamiento de los alimentos congelados varía y se recomienda almacenarlos solamente mientras esté vigente la fecha de expiración.
- ? Alimentos congelados preenvasados comercialmente deben ser almacenados de acuerdo con las indicaciones de su fabricante.
- ? Coloque los alimentos congelados dentro de su electrodoméstico inmediatamente después de comprarlos. Si hay indicaciones en el envase, sígalas cuidadosamente considerando el tiempo de almacenamiento.

CUIDADO Y MANTENIMIENTO

Limpiando su electrodoméstico

- ? Gire el control de temperatura a "OFF", desconecte el electrodoméstico y retire los alimentos.
- ? Lave el interior con agua tibia y un trapo suave remojado en una solución de Bicarbonato de Sodio. La solución consiste en 2 cucharadas del referido compuesto químico y un litro de agua.
- ? Lave la canasta de almacenaje con un detergente suave.
- ? Las partes externas de su electrodoméstico deben ser limpiadas con un detergente suave y agua tibia.

ADVERTENCIA

Asegúrese de desconectar el electrodoméstico de la corriente eléctrica. Si no lo hace, puede ocasionar un choque eléctrico o herirse.

Si falla el suministro eléctrico

Usualmente la electricidad regresa en unas pocas horas sin afectar la temperatura de su electrodoméstico, siempre que la puerta no se abra muy frecuentemente. Si le va a faltar electricidad por un período de tiempo más largo, usted debe tomar los pasos apropiados para proteger sus alimentos.

Si usted sale de vacaciones

Retire todos los alimentos si va a estar ausente por un período largo; desconecte y limpie su electrodoméstico.
Deje la puerta del electrodoméstico ligeramente abierta para evitar la formación de mal olor y moho.

Reemplazando La Bombilla

Antes de cambiar la bombilla, desconecte el refrigerador de la electricidad.

1. Cambie la bombilla primero empujando hacia arriba la parte inferior de la capa plástica como muestra el gráfico.
2. Hale hacia abajo para quitar la capa plástica.
3. Reemplace la bombilla con una equivalente de 10 watts.
4. Vuelva a colocar la capa plástica.

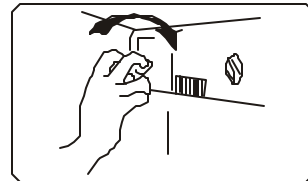
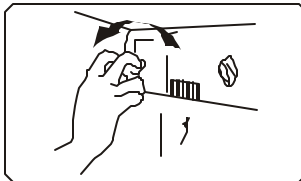
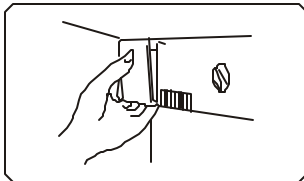

Para mover su electrodoméstico

- ? Retire los alimentos.
- ? Asegúrese de colocar cinta adhesiva a todo lo que se puede caer dentro de su electrodoméstico.
- ? Retire las patas para prevenir que se dañen.
- ? Selle las puertas con cinta adhesiva.
- ? Asegúrese que el electrodoméstico se mantenga parado durante el traslado.

Consejos para ahorrar energía

- ? Su electrodoméstico debe estar ubicado en el área más fría de la habitación, alejado de electrodomésticos que produzcan calor o conductos de aire caliente y lejos de los rayos solares.
- ? Los alimentos calientes deben estar a temperatura ambiental antes de colocarlos en el electrodoméstico. Si sobrecarga su electrodoméstico forzará al compresor a funcionar más tiempo del normal. Los alimentos que se congelan lentamente pierden calidad y se malogran.
- ? Asegúrese de envolver adecuadamente los alimentos y de secar los empaques o contenedores antes de colocarlos dentro del electrodoméstico. Colocarlos mojados ocasiona escarcha en el electrodoméstico.
- ? La canasta de almacenaje de su electrodoméstico no debe ser forrada con papel aluminio, papel de cera o papel toalla ya que esto interfiere con la circulación del aire frío restando eficiencia a su electrodoméstico.
- ? Organice y coloque etiquetas en los envases de los alimentos con la finalidad de abrir el electrodoméstico lo menos posible y encontrar rápidamente lo que usted está buscando. Retire la mayor cantidad posible de cosas que necesita a la vez y cierre la puerta del electrodoméstico tan pronto le sea posible.

PROBLEMAS CON SU ELECTRODOMESTICO

Usted puede resolver muchos problemas comunes de su electrodoméstico fácilmente, ahorrándole el gasto de una posible visita del servicio técnico.

Pruebe las siguientes sugerencias para verificar si usted puede resolver el problema antes de llamar al servicio técnico.

GUIA PARA SOLUCIONAR PROBLEMAS

PROBLEMA	SOLUCION
Su electrodoméstico no funciona.	No está conectado a la corriente eléctrica. El interruptor saltó o se quemó un fusible. El control de temperatura está en "OFF".
El compresor se enciende y se apaga frecuentemente.	La temperatura de la habitación es más caliente de lo normal. Colocó demasiados alimentos descongelados al mismo tiempo. La puerta permanece abierta mucho tiempo. La puerta no quedó completamente cerrada. El control de temperatura no está funcionando correctamente. La empaquetadura de la puerta no está sellada adecuadamente. El electrodoméstico no tiene el suficiente espacio libre.
Vibración.	Asegúrese que el electrodoméstico esté ubicado en un lugar totalmente plano.
Sonido de burbujeo, goteo, como agua que hierve o crujidos.	Esto es normal. Es el refrigerante (usado para enfriar el electrodoméstico) que está circulando a través del sistema. La contracción y expansión de las paredes internas puede ocasionar sonidos como crujidos.
La puerta no cierra completamente.	El electrodoméstico no está totalmente nivelado. La dirección de apertura de la puerta fue invertida pero instalada incorrectamente. El sellador de la puerta está sucio. La canasta de almacenaje está fuera de su sitio obstaculizando el cierre de la puerta.

PRINTED IN CHINA