

**KENWOOD**

CD PLAYER

**DP-M4010**

**INSTRUCTION MANUAL**

KENWOOD CORPORATION



# Introduction

Your choice of this product indicates that you are a devotee to excellence in sound reproduction.

We appreciate your patronage and take pride in the long tradition of quality components, that our company represents.

So that you can get the most out of your unit, we suggest that you take the time to read through this manual before you hook up and operate your system.

This will acquaint you with operating features, and system-connection considerations, so that your listening pleasure will be enhanced right from the start. You will notice that in all aspects of planning, engineering, styling, operating convenience and adaptability, we have sought to anticipate your needs and desires.

**Keep this manual handy for future reference.**

## For your records

Record the serial number, found on the back of the unit, in the spaces designated on the warranty card, and in the space provided below. Refer to the model and serial numbers whenever you call upon your dealer for information or service on this product.

Model DP-M4010 Serial Number \_\_\_\_\_

## Unpacking

Unpack the unit carefully and make sure that all accessories are put aside so they will not be lost.

Examine the unit for any possibility of shipping damage. If your unit is damaged or fails to operate, notify your dealer immediately. If your unit was shipped to you directly, notify the shipping company without delay. Only the consignee (the person or company receiving the unit) can file a claim against the carrier for shipping damage.

We recommend that you retain the original carton and packing materials for use should you transport or ship the unit in the future.

**CAUTION:** Use of controls or adjustments or performance of procedures other than those specified herein may result in hazardous radiation exposure.

In compliance with Federal Regulations, following are reproductions of labels on, or inside the product relating to laser product safety.

KENWOOD CORPORATION  
SHIONOGI SHIBUYA BUILDING 17-5, 2-CHOME,  
SHIBUYA, SHIBUYA-KU, TOKYO, JAPAN

KENWOOD CORP. CERTIFIES THIS EQUIPMENT  
CONFORMS TO DHHS REGULATIONS NO. 21 CFR  
1040.10, CHAPTER I, SUBCHAPTER J.

Location: Back Panel

**DANGER**  
INVISIBLE LASER RADIATION WHEN OPEN  
AND INTERLOCK FAILED OR DEFEATED.  
AVOID DIRECT EXPOSURE TO BEAM.

Location: Inside, near the Laser mechanism.

## Accessories

- Audio cord ..... 1
- System control cord ... 1  
(with mini plugs)  
(Except for the U.K. and Europe)



- Battery  
("AA" or "R6") ..... 2

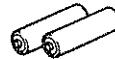

- Magazine ..... 1  
(with 6 disc trays)

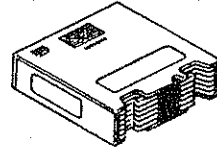

- Remote control unit ... 1  
(RC-PM4010)

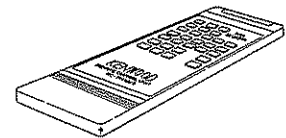

## Contents

**Caution:** Read the following pages marked in  $\triangle$  carefully to keep your safety.

$\triangle$ Before applying power .....	3	Programming .....	14
$\triangle$ Important safeguards .....	4	Checking a program .....	15
Before operation .....	6	Changing a program .....	15
System connections .....	7	Playing a program .....	15
Controls and indicators .....	8	Playing from a particular track of a program ..	15
Remote control unit .....	9	Stopping programmed play .....	15
Preparing to play .....	10	Adding a track .....	15
Manual play (Track mode) .....	12	Erasing a program .....	15
Playing all the discs in the magazine .....	12	Repeated playing .....	16
Pausing play .....	12	To repeat all the tracks .....	16
Stopping play .....	12	To repeat play of a single track .....	16
Playing from a desired track .....	13	Random playing .....	17
Listening to the next track or previous track ...	13	Time display switching and timer playing .....	18
Forward and reverse searching .....	13	In case of difficulty .....	19
Programmed play (Program mode) .....	14	Specifications .....	20

# Before applying power ⚠ Caution: Read this page carefully to keep your safety.

## For the U.S.A. and Canada

### Important!

Units shipped to the U.S.A. and Canada are designed for operation on 120 volts AC only.

## For Australia and Europe

### Important!

Units shipped to Australia are designed for operation on 240 V AC only.

Units shipped to Europe are designed for operation on 220 V AC only.

## For the United Kingdom

### Important!

Units shipped to the U.K. are designed for operation on 240 volts AC only.

The mains plug must be removed from the wall socket prior to any internal examination.

The wires in this mains lead are coloured in accordance with the following code:

Blue ..... Neutral  
Brown ..... Live

The wires in this mains lead must be connected to the terminals in the plug as follows:

Wire colour	Plug terminal marking
Blue .....	N or Black
Brown .....	L or Red

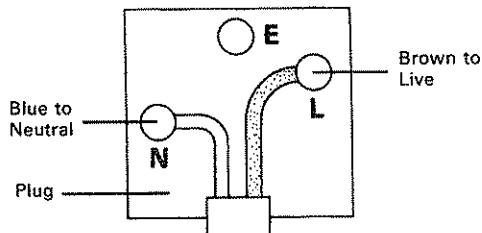

#### Notes:

1. If a 13-amp plug is used, this must be fitted with a 5-amp fuse.
2. If a 3-pin plug with earthing contact is used, no wire must be connected to the E terminal.

## For other countries

### Important!

Units shipped to countries other than the above countries are equipped with an AC voltage selector switch on the rear panel. Refer to the following paragraph for the proper setting of this switch.

#### AC voltage selection

This unit operates on 110-120 or 220-240 volts AC. The AC voltage selector switch on the rear panel is set to the voltage that prevails in the area to which the unit is shipped. Before connecting the power cord to your AC outlet, make sure that the setting position of this switch matches your line voltage. If not, it must be set to your voltage in accordance with the following directions.

#### Note:

Our warranty does not cover damage caused by excessive line voltage due to improper setting of the AC voltage selector switch.

AC 110-120V ~ ⚡ AC 220-240V ~ AC 110-120V ~ ⚡ AC 220-240V ~

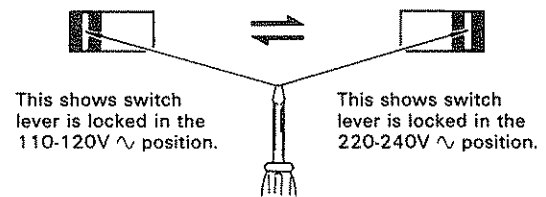

This shows switch lever is locked in the 110-120V ~ position.





This shows switch lever is locked in the 220-240V ~ position.

Move switch lever to match your line voltage with a small screwdriver or other pointed tool.

#### AC voltage selector switch

## Safety precautions

**WARNING:** TO PREVENT FIRE OR SHOCK HAZARD, DO NOT EXPOSE THIS APPLIANCE TO RAIN OR MOISTURE.

 <div data-bbox="343 1648 594 1732" style="border: 1px solid black; padding: 5px; text-align: center;"> <b>CAUTION</b>              RISK OF ELECTRIC SHOCK              DO NOT OPEN         </div> 	<p>CAUTION: TO REDUCE THE RISK OF ELECTRIC SHOCK, DO NOT REMOVE COVER (OR BACK). NO USER-SERVICEABLE PARTS INSIDE, REFER SERVICING TO QUALIFIED SERVICE PERSONNEL.</p>
	<p>THE LIGHTNING FLASH WITH ARROWHEAD SYMBOL, WITHIN AN EQUILATERAL TRIANGLE, IS INTENDED TO ALERT THE USER TO THE PRESENCE OF UNINSULATED "DANGEROUS VOLTAGE" WITHIN THE PRODUCT'S ENCLOSURE THAT MAY BE OF SUFFICIENT MAGNITUDE TO CONSTITUTE A RISK OF ELECTRIC SHOCK TO PERSONS.</p>
	<p>THE EXCLAMATION POINT WITHIN AN EQUILATERAL TRIANGLE IS INTENDED TO ALERT THE USER TO THE PRESENCE OF IMPORTANT OPERATING AND MAINTENANCE (SERVICING) INSTRUCTIONS IN THE LITERATURE ACCOMPANYING THE APPLIANCE.</p>

# IMPORTANT SAFEGUARDS Caution : Read this page carefully to keep your safety.

Please read all of the safety and operating instructions before operating this unit. For best results, follow all warnings placed on the unit and adhere to the operating and use instructions. These safety and operating instructions should be retained for future reference.

**1. Power sources** — The unit should be connected to a power supply only of the type described in the operating instructions or as marked on the appliance.

**2. Power-cord protection** — Power-supply cords should be routed so that they are not likely to be walked on or pinched by items placed upon or against them, pay particular attention to cords at plugs, convenience receptacles, and the point where they exit from the unit.

Never pull or stretch the cord.

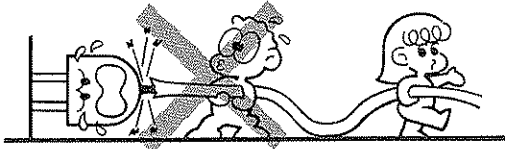

**3. Grounding or polarization** — The precautions should be taken so that the grounding or polarization means of this unit is not defeated.

**4. Ventilation** — The unit should be situated so that its location or position does not interfere with its proper ventilation.

To maintain good ventilation, do not put records or a table-cloth on the unit. Place the unit at least 10 cm away from the walls.

Do not use the unit on a bed, sofa, rug or similar surface that may block the ventilation openings.

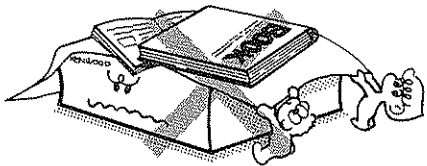

**5. Water and moisture** — The unit should not be used near water — for example, near a bathtub, washbowl, kitchen sink, laundry tub, in a wet basement, or near a swimming pool, etc.

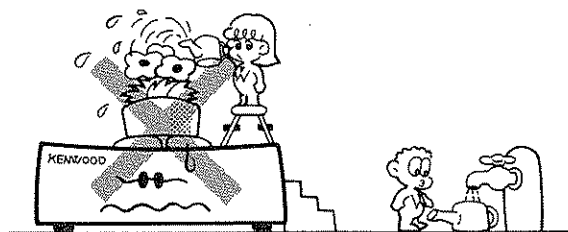

**6. Temperature** — The unit may not function properly if used at extremely low, or freezing temperatures. The ideal ambient temperature is above +5°C (41°F).

**7. Heat** — The unit should be situated away from heat sources such as radiators, heat registers, stoves, or other units (including amplifiers) that produce heat.

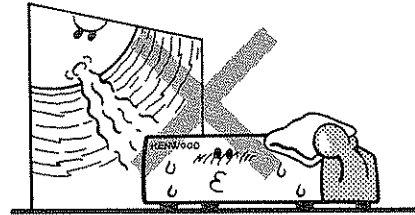

**8. Electric shock** — Care should be taken so that objects do not fall and liquid is not spilled into the enclosure through openings. If a metal object, such as a hair pin or a needle, comes into contact with the inside of this unit, a dangerous electric shock may result. For families with children, never permit children to put anything, especially metal, inside this unit.

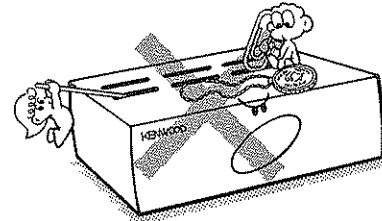

**9. Enclosure removal** — Never remove the enclosure. If the internal parts are touched accidentally, a serious electric shock might occur.

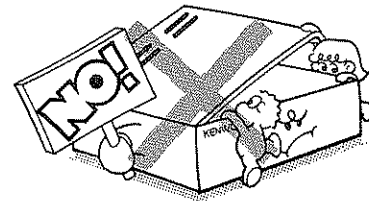

**10. AC outlets** — Do not connect other audio equipment with a power consumption larger than that specified to the AC outlet on the rear panel. Never connect other electrical units, such as an iron or toaster, to it to prevent fire or electric shock.

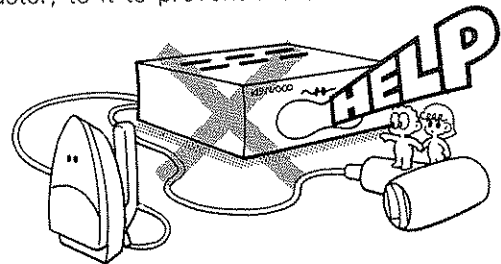

**⚠ Caution : Read this page carefully to keep your safety.**

**11. Magnetic fields** — Keep the unit away from sources of magnetic fields such as TV sets, speaker systems, radios, motorized toys or magnetized objects.

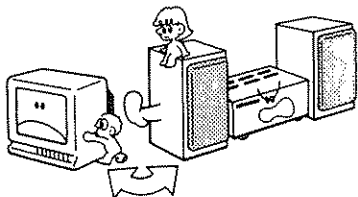

**12. Cleaning** — Do not use volatile solvents such as alcohol, paint thinner, gasoline, or benzine, etc. to clean the cabinet. Use a clean dry cloth.

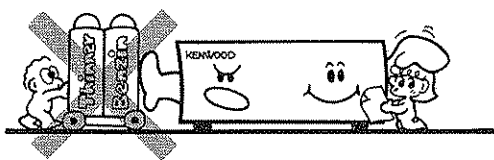

**13. Carts and stands** — An appliance and cart combination should be moved with care. Quick stops, excessive force, and uneven surfaces may cause the appliance and cart combination to overturn.



**14. Nonuse periods** — The power cord of the unit should be unplugged from the outlet when left unused for a long period of time.

**15. Abnormal smell** — If an abnormal smell or smoke is detected, immediately turn the power OFF and pull out the power cord. Contact your dealer or nearest service center.

**POWER OFF!**

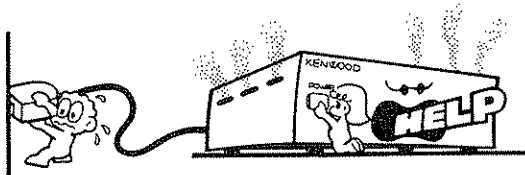

**16. Damage requiring service** — The unit should be serviced by qualified service personnel when:

- A. The power-supply cord or the plug has been damaged; or
- B. Objects have fallen, or liquid has been spilled into the unit; or
- C. The unit has been exposed to rain; or
- D. The unit does not appear to operate normally or exhibits a marked change in performance; or
- E. The unit has been dropped, or the enclosure

**17. Servicing** — The user should not attempt to service the unit beyond that described in the operating instructions. All other servicing should be referred to qualified service personnel.

**18. Outdoor antenna grounding** — If an outside antenna is connected to the receiver, be sure the antenna system is grounded so as to provide some protection against voltage surges and built up static charges. Section 810 of the National Electrical Code, ANSI/ NFPA No. 70—1984, provides information with respect to proper grounding of the mast and supporting structure, grounding of the lead-in wire to an antenna discharge unit, size of grounding conductors, location of antenna-discharge unit, connection to grounding electrodes, and requirements for the grounding electrode. See Figure.

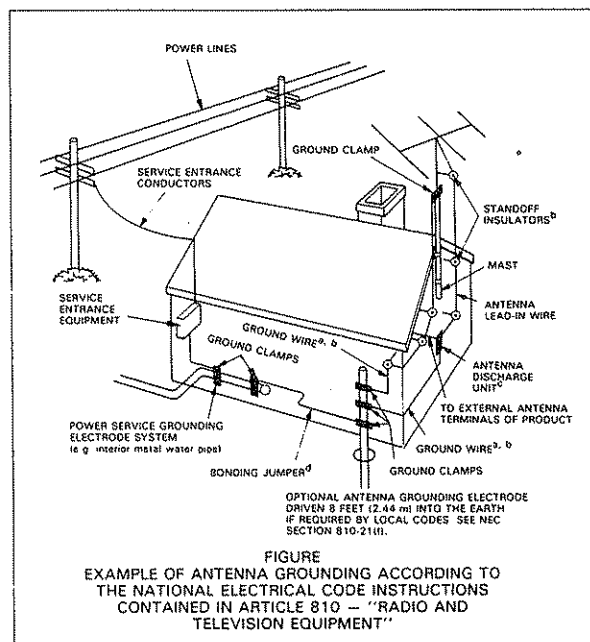

<sup>a</sup> Use No. 10 AWG (5.3 mm<sup>2</sup>) copper, No. 8 AWG (8.4 mm<sup>2</sup>) aluminum, No. 17 AWG (1.0 mm<sup>2</sup>) copper-clad steel or bronze wire, or larger, as a ground wire.

<sup>b</sup> Secure antenna lead-in and ground wires to house with stand-off insulators spaced from 4 — 6 feet (1.22 — 1.83 m) apart.

<sup>c</sup> Mount antenna discharge unit as close as possible to where lead-in enters house.

<sup>d</sup> Use jumper wire not smaller than No. 6 AWG (13.3 mm<sup>2</sup>) copper, or the equivalent, when a separate antenna-grounding electrode is used. See NEC Section 810-21(j)

**19. Power lines** — An outdoor antenna should be located away from power lines.

**Notes:**

- 1. Item 3 is not required except for grounded or polarized equipment.
- 2. Item 10 is not required except for units provided with AC outlets.
- 3. Item 18 and 19 are not required except for units provided with antenna terminals.
- 4. Item 18 complies with UL-1270 in the U.S.A.

# Before operation

## ■ Removal of packing materials (protective material) for transportation

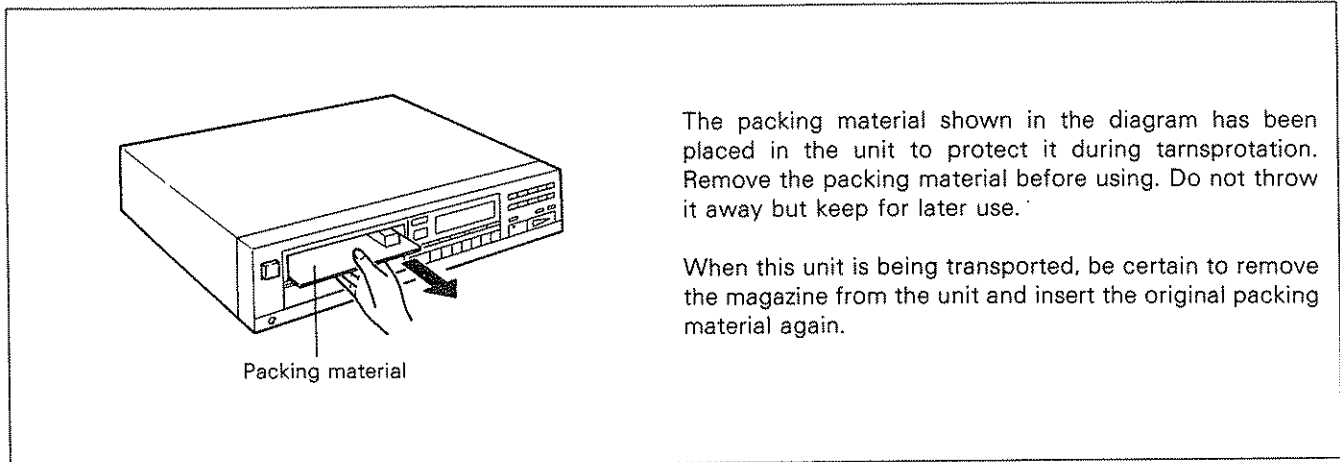

The packing material shown in the diagram has been placed in the unit to protect it during transportation. Remove the packing material before using. Do not throw it away but keep for later use.

When this unit is being transported, be certain to remove the magazine from the unit and insert the original packing material again.

## ■ Beware of condensation

Water vapor in the air may condense on cold parts, forming "dew" on its surface.

For example, when a bottle is taken out of the refrigerator and brought into a warm room, droplets of water will form on the bottle surface. This phenomenon is called "condensation". If this occurs inside the unit the player may operate incorrectly or may not function at all.

This is not a malfunction, however, the player should be left until it is dry. (Turn the power of this unit ON and leave the player for a while. After several hours, even in the worst

case, the player will stabilize and correct playback will be possible.) Be especially careful in the following cases:

- When the unit is suddenly brought from a cold place to a warm place (causing rapid temperature change).
- When the temperature of the room is raised suddenly using a heater, etc.
- When the unit is brought from a well-cooled (airconditioned) room to a damp and hot room.
- In conditions where the temperature difference between the surroundings and this unit might cause condensation.

# System connections

Do not insert the power plug into the socket until all connections are completed.

Connect the output terminals of this unit to the amplifier or receiver input terminals (CD, AUX etc.) by the supplied audio cord.

Also refer to the manual for the amplifier to which the connection is to be made.

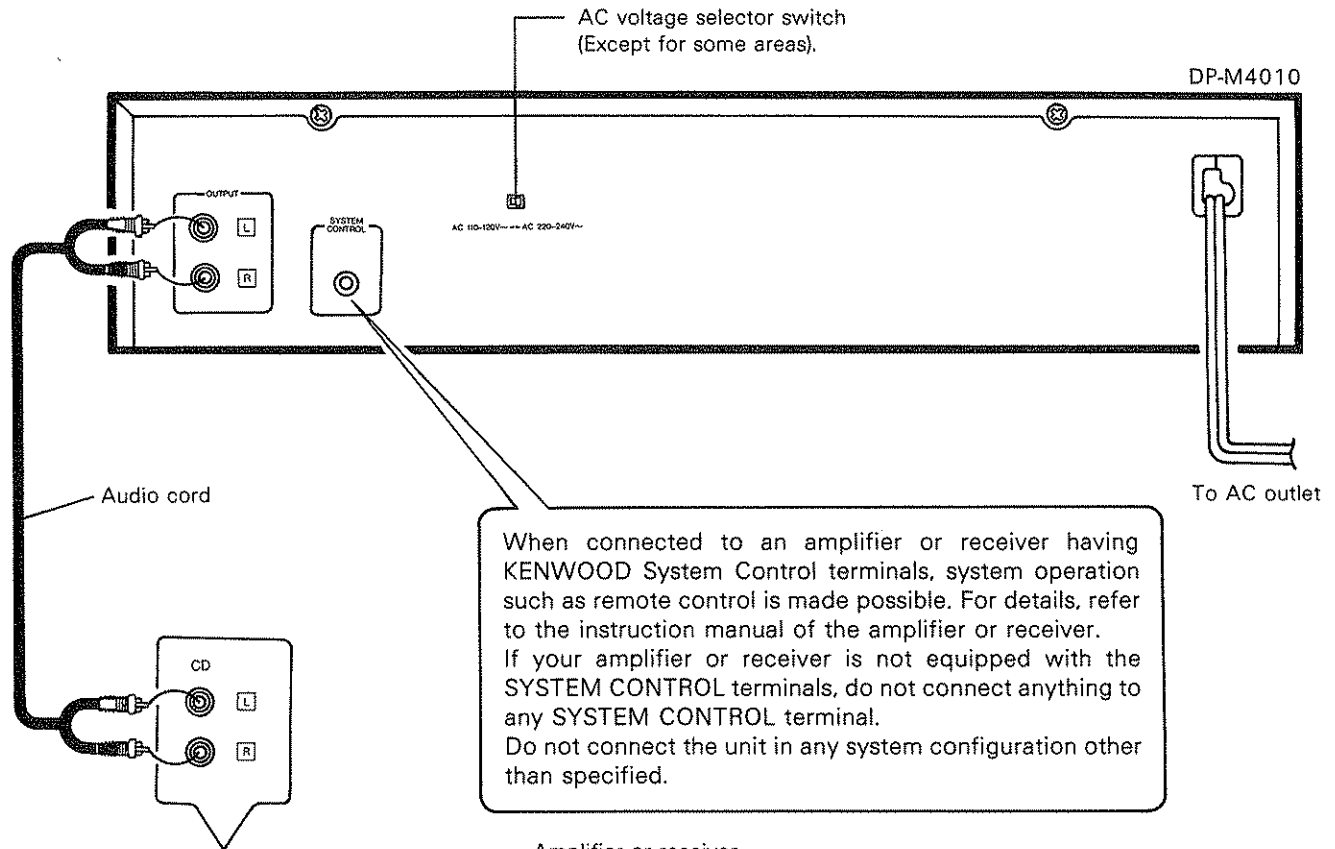

Amplifier or receiver

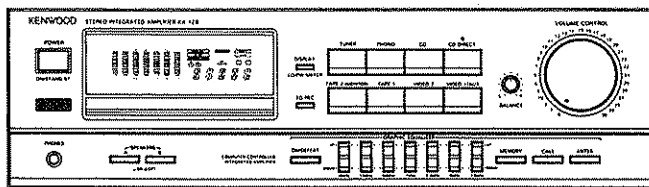

## Notes:

1. Be sure that all the cords are connected properly. If they are not, the sound may not be produced or there may be noise interference.
2. When taking out and putting in the connecting cords, be sure to turn the power of this unit OFF and turn the amplifier's volume to minimum. If this is not done, it can lead to errors in functioning.

## ■ Connecting power cord

It is useful to connect the power cord for this unit to the linking power socket (SWITCHED) of an amplifier (Except for some areas).

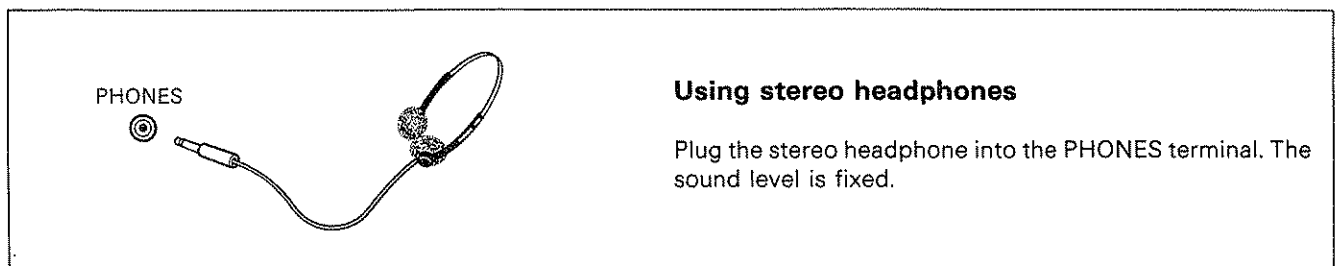

# Controls and indicators

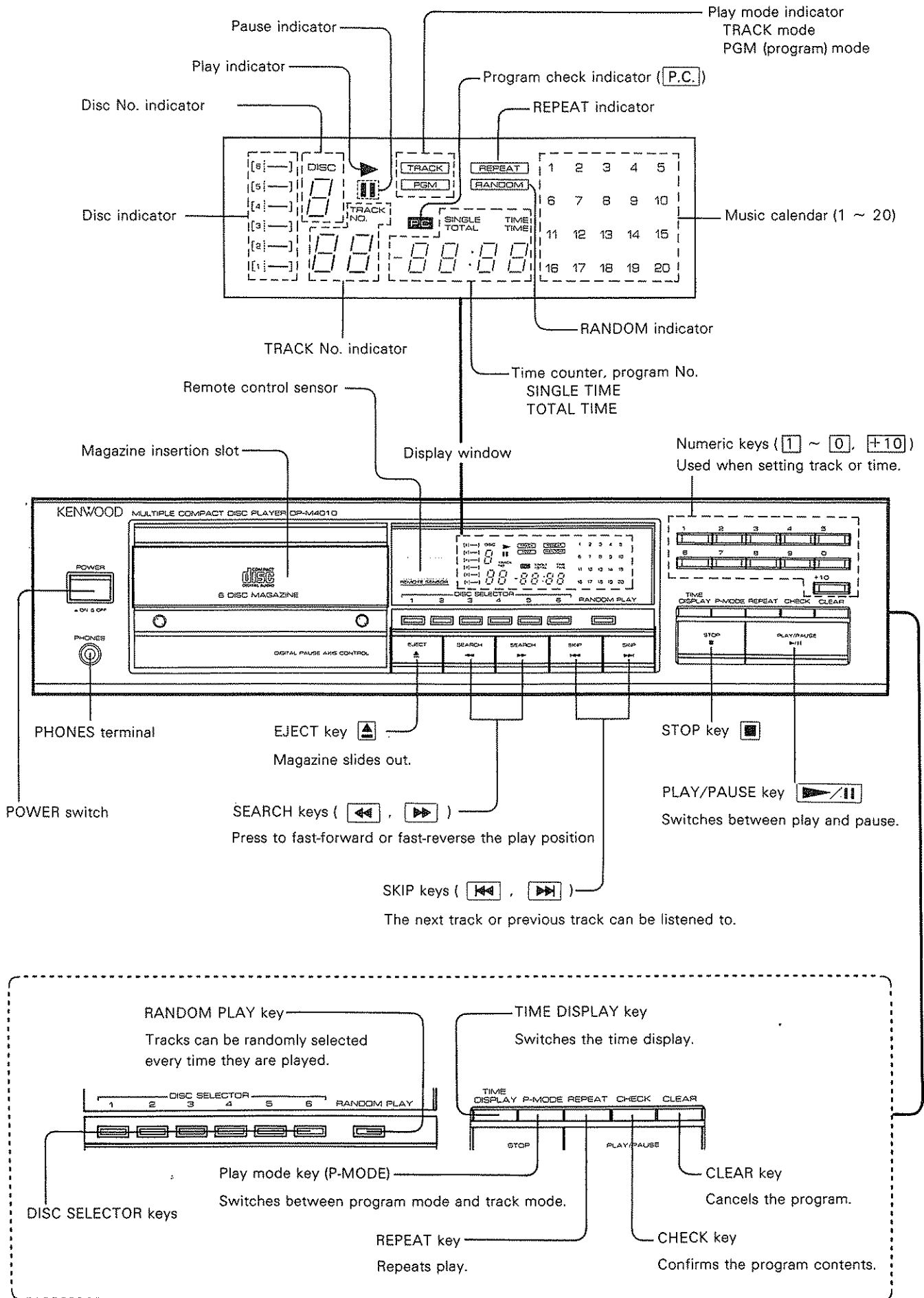



# Remote control unit

All the keys have the same functions as the front panel controls.

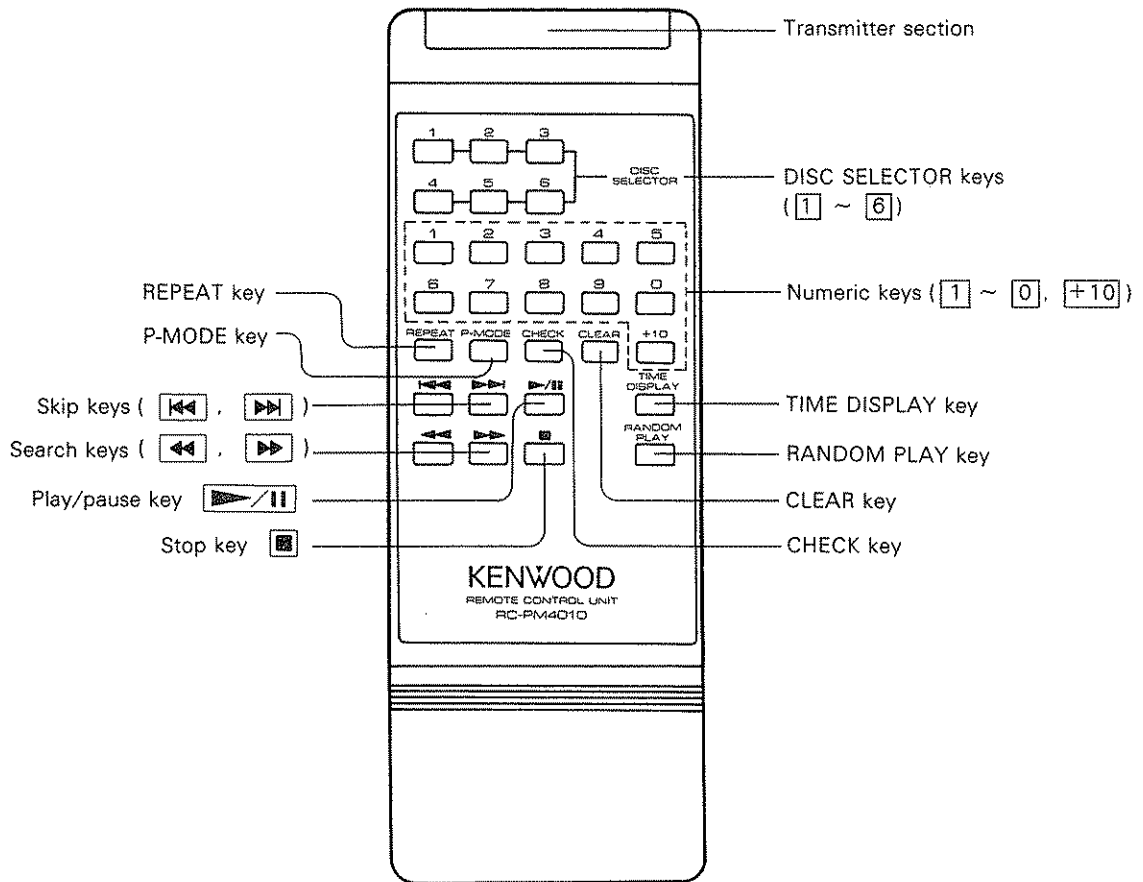

## ■ Operating range of remote control unit

This functions as shown in the diagram below, although there can be variations depending on the temperature, humidity and place of use.

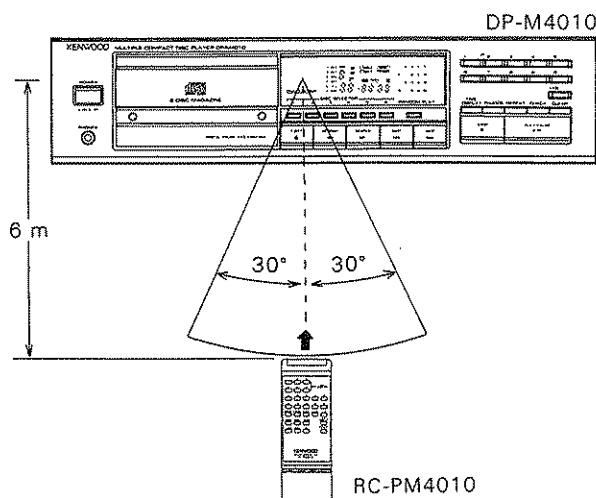

**Note:**  
Press the remote control operating keys at intervals of at least one second. If you press the next key too quickly, incorrect operation may sometimes occur.

## ■ Supplying batteries for the remote control unit

Load two "R6", "AA" type batteries in the remote control unit as shown in the illustration.

### 1. Remove the cover.

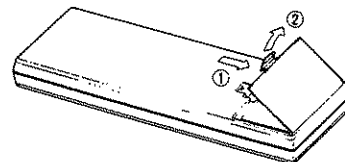

### 2. Insert batteries with correct polarity, and close the cover.

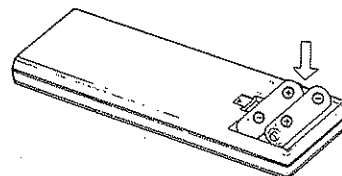

**Note:**  
The provided batteries are to be used for checking the operation of the remote control unit, and they may have shorter life than normal. When the remote control unit becomes effective only for shorter distance or is not effective for operation, replace them with two new batteries.

# Preparing to play

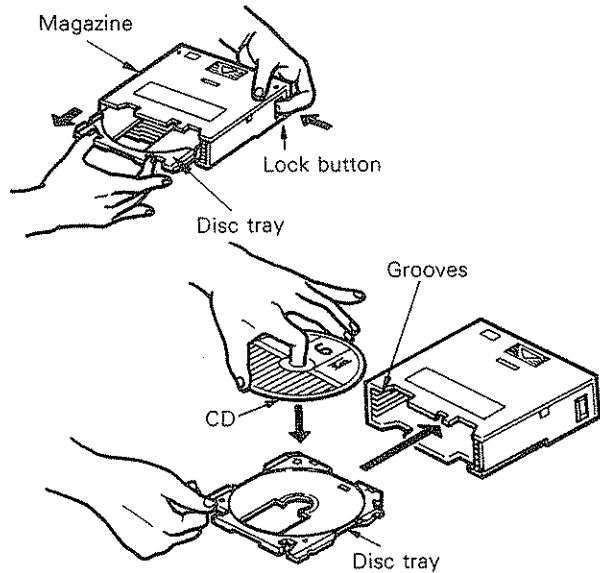

## ■ Inserting a disc into the magazine

1. Press the magazine lock button and take out the disc tray.
2. With the label upwards, correctly insert the disc into the disc tray.
3. Slide the disc tray horizontally along the left side and right side grooves of the magazine and insert it completely.
  - It is not necessary to press the lock button.

### Notes on handling the magazine:

1. If the disc tray is inserted aslant into the magazine the unit will not operate.

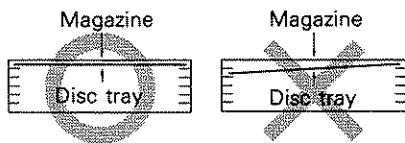

2. The disc must be only inserted in the magazine after it has been inserted in the tray. If it is inserted directly the unit will not operate.

3. Always keep the magazine loaded with six disc trays.
4. After playing the disc, remove it from both the magazine and tray. Store avoiding places of direct sunlight, high temperature and high humidity.
5. Do not alter the magazine or tray in any manner.
6. Do not drop, apply excessive force or subject to shock the magazine or tray.
7. Do not use benzine, paint thinner or cleaning detergents. It is possible that surface will dissolve.

## ■ Types of disc which can be played with this unit

Disc type	Disc size
CD (general compact disc)	12 cm
* CDV (CD with video) audio section	12 cm

The 8 cm CD adaptor on sale cannot be used with this unit. If it is used with this unit, it is possible that the disc or CD player will be damaged.

\* In the case of CDV, the time display and music calendar displays are all for the audio section only.

## ■ Notes on handling compact discs

### Handling

Compact discs are made of plastic (polycarbonate). When the recorded side of the compact disc is dirty or scratched, playback may be noisy or sound may be missed. Even when the label side is scratched, the recording may be damaged. Handle compact discs carefully. Do not stick tape, etc. to compact discs.

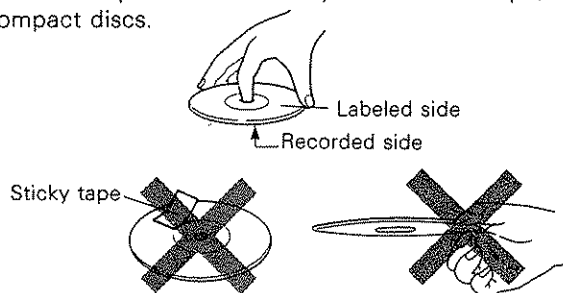

### Cleaning

When a compact disc is contaminated with fingerprints, etc., wipe with a dry cloth in a radial direction. Never use chemical solvents, such as thinner, benzene, etc. and conventional record cleaners or aerosols.



### Storage

Always replace the compact disc in its case and store it. Compact discs are adversely affected by heat and moisture. Do not store compact discs in a place exposed to direct sunlight or where humidity is high.

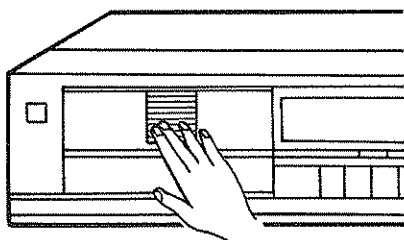
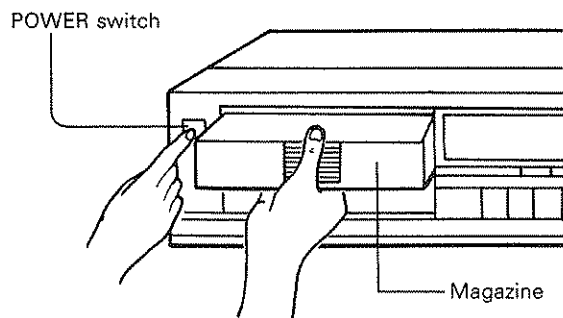

### When the power has been turned on

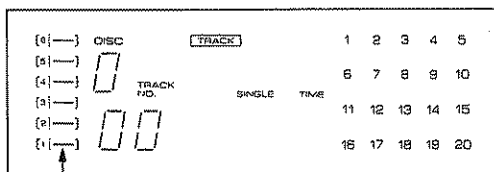

All indicator illuminated whether or not a disc is present.

### When putting in magazine

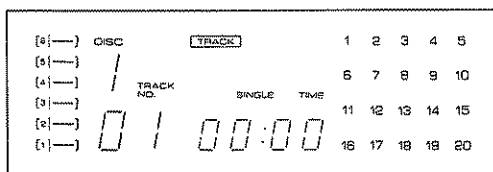

Displays as above and remains at standby.

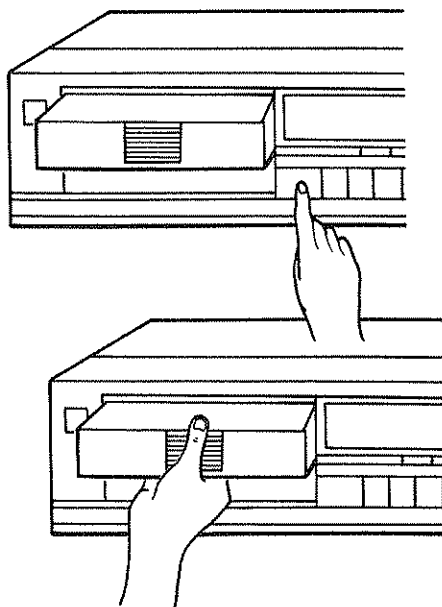

## ■ How to insert the magazine

1. Press the POWER switch to turn on.
2. Insert a magazine containing discs.
3. Firmly press the magazine until a click can be heard.

### Disc indicator [ - ] display

All of the disc indicator [ - ] of this unit illuminates, whether or not a disc is present, when the power is switched on or a magazine is inserted.

When about to play a desired disc, it informs you that a disc is not inserted by going out.

Even when a disc is not present, it remains illuminated until normal play or program play is selected.

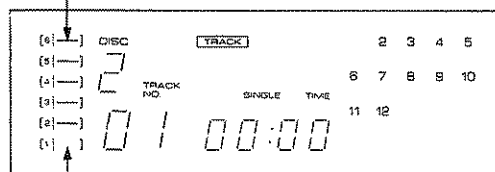

Shows no disc present

(It will not operate even if the key of a non-illuminated DISC NO. is pressed)

## ■ How to remove the magazine

1. Press the EJECT key .
2. Remove the magazine towards you.

### Notes:

1. When the power is switched on, if a magazine and disc are already inserted, this unit will automatically start to play.
2. Hold the magazine by the central section when inserting or removing it.
3. When the unit is to be transported, be sure to remove the magazine pack from the main body.

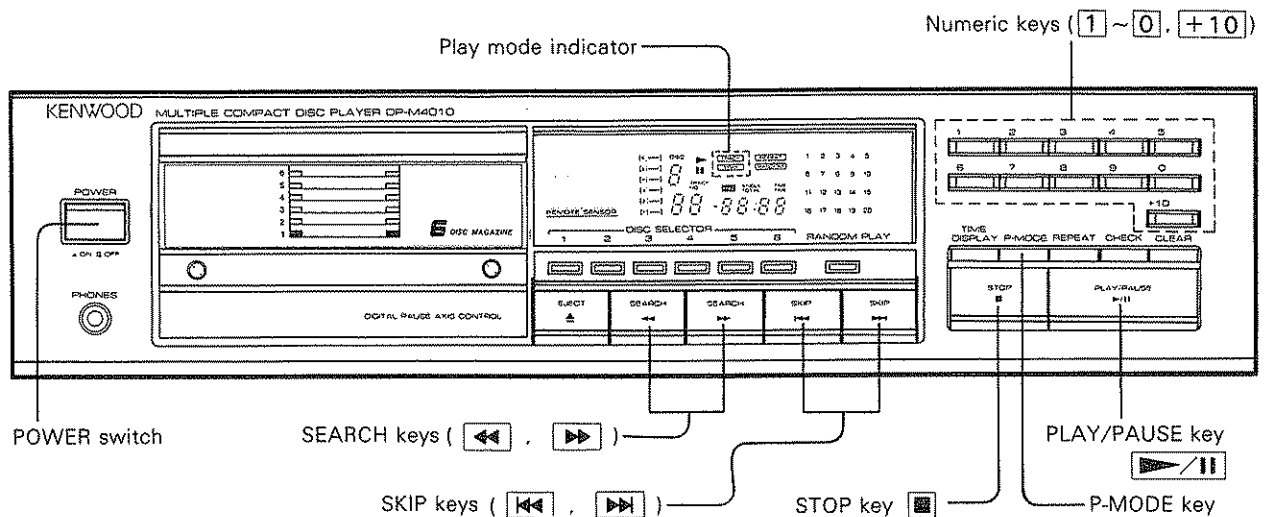

## ■ Playing all the discs in the magazine

1. Press the **POWER** switch to turn on.

2. Insert a magazine containing discs.

3. Check that the play mode indicator is on **TRACK**.  
 ● If it is on **PGM**, press the **P-MODE** key to make **TRACK** light up.

4. Press the **PLAY/PAUSE** key .  
 ● The play indicator (▶) illuminates and play starts from the first track on the first disc.  
 ● If there is no disc present, play begins with the next disc.  
 ● When playing of the last disc has finished, it stops.

Confirm that **TRACK** is illuminating

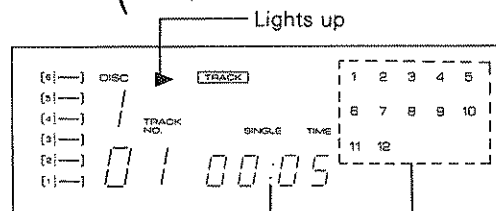
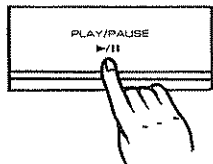
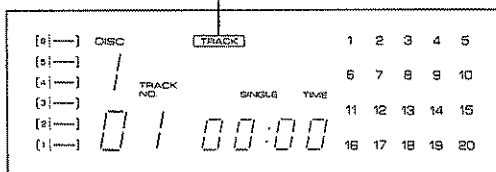

Lights up  
 Indicates the time elapsed  
 Indicates recorded track numbers

## Example of pausing play at the third track

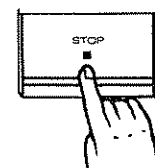
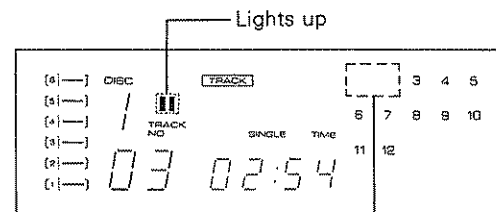

The numbers of the tracks already played are erased in order

## ■ Pausing play

Press the **PLAY/PAUSE** key .

- The pause indicator (||) will light up and play will stop at that point.
- When the **PLAY/PAUSE** key is pressed again, play will resume from that point.

## ■ Stopping play

Press the **STOP** key .

- The play indicator (▶) goes out and the play stops.
- To stop play, press the **POWER** switch after pressing **STOP** key .

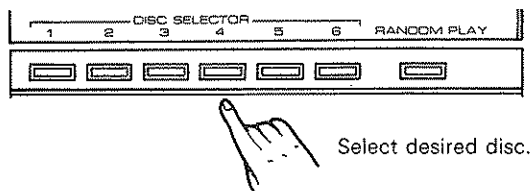

Example: When starting play from 13th track

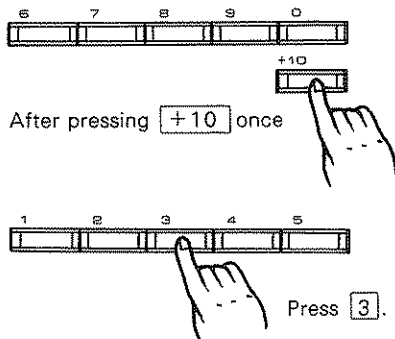

Example of starting play from 13rd track

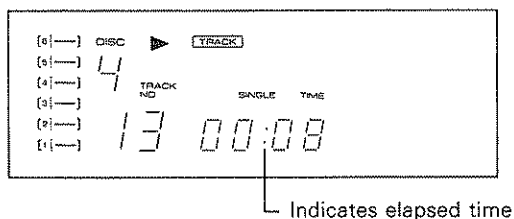

## ■ Playing from a desired track

1. Select the desired DISC No. with the DISC SELECTOR keys **1** ~ **6**.

- If a number with no disc is loaded, it will move on to the next disc.

2. Within 5 seconds after the disc is selected, input the track number of the desired track by the numeric keys **1** ~ **0**, **+10**.

### Input example:

For the 40th tune, after pressing **+10** four times, press **0**.

- Play starts from the selected track number of the selected disc. When the last disc has finished playing, it stops.
- If the numeric keys are not pressed after selecting a disc, play starts from the first tune of the selected disc.

### Note:

If a track number is specified for which there does not exist a tune on the disc, it is possible that it will automatically play from either the last or first tune. However, if the non-existent track number key is pressed during play, it will have no effect.

## ■ Listening to the next track or previous track

Press the SKIP keys **▶▶** (or **◀◀**) while looking at the TRACK number on the display.

- Press once to select to the next track (or the previous track). Press repeatedly or keep the key depressed to select several tracks ahead (or several tracks backward).
- Play will start from the beginning of the selected track.
- When the **◀◀** key is pressed once during play, the track starts again from the beginning.
- Play can also be started during a pause by operating the SKIP keys and pressing the PLAY/PAUSE key **▶▶/||** after selecting the track.

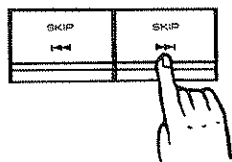

When this key is pressed while the player is stopped, play will start from the beginning of the second track.

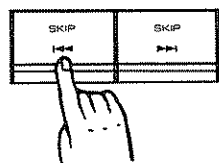

When this key is pressed while the player is stopped, play will start from the beginning of the last track.

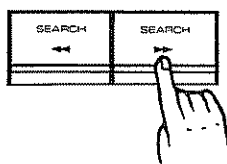

When one of these keys is pressed during play you will hear a cueing sound as the pickup moves forward or backward across the disc. If you release the key referring to this sound, normal play will be returned from that point.

## ■ Forward and reverse searching

During play you can search forward (or backward) at high speed by pressing the SEARCH keys **▶▶** (or **◀◀**).

- If the **◀◀** key is pressed continuously and it returns to the beginning of that disc, it enters the pause state.

# Programmed play (Program mode)

It is possible to program and play a maximum of 32 tunes in a desired sequence.

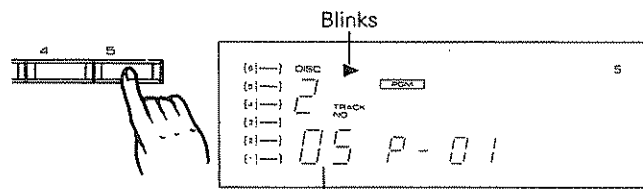
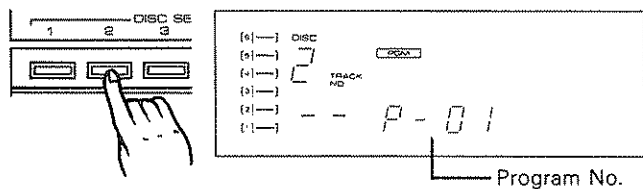
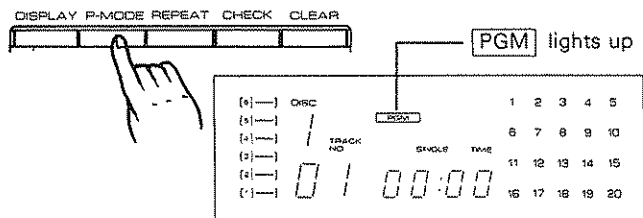
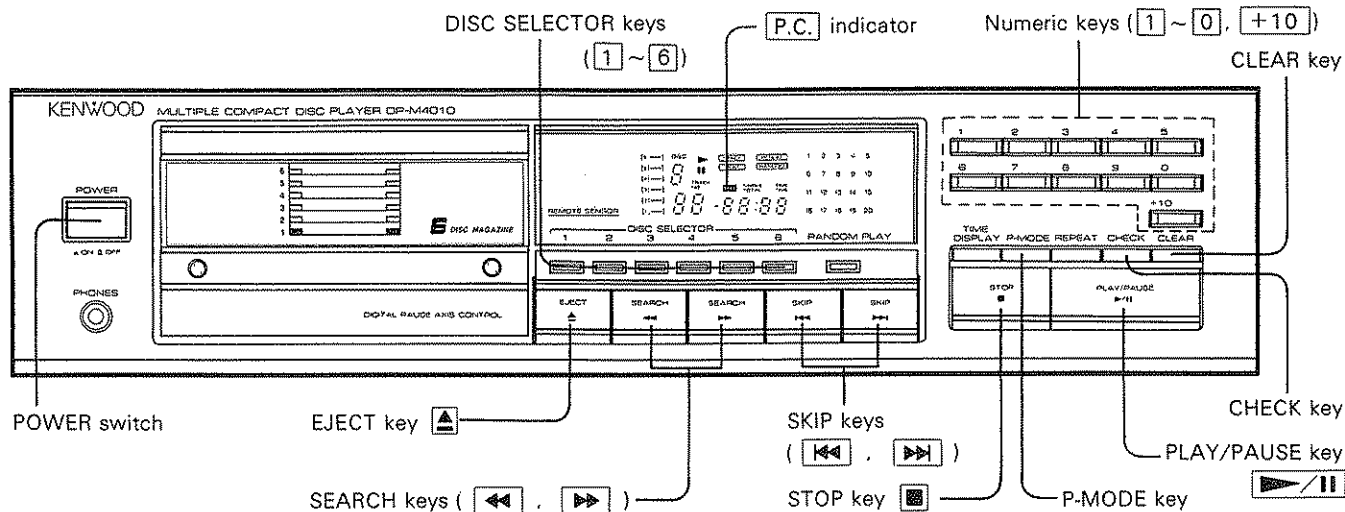

Selected track No. ↓ Several seconds later

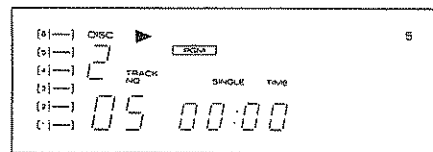

## AUTO SPACE function

When in the program mode, intervals with no sound of about 4 seconds are created between the programmed tracks. This function is for making use of the DPSS system on the cassette deck.

## Programming

1. Press the P-MODE key to put in the program mode.

2. Select the desired disc number by the DISC SELECTOR keys 1 ~ 6.

- Example: If the 2 is pressed, the indicator becomes as shown on the left diagram.

3. Select the desired track numbers with numeric keys 1 ~ 0 and +10 within 5 seconds after the disc is selected.

- Example: While the display is as indicated in the diagram on the left when 5 is pressed, you can program the next track without waiting for the display to change.
- You can specify up to 32 programs in the same operation as steps 2 and 3.
- When programming tunes on the same disc, selection can be made by only using the numeric keys 1 ~ 0 and +10.
- If you select a wrong track number, press the clear key once, then select the desired track again.
- When disc numbers or track numbers are specified which do not exist, these numbers are initially programmed. But when the play starts, they are automatically canceled.

### Example of when the CHECK key is pressed

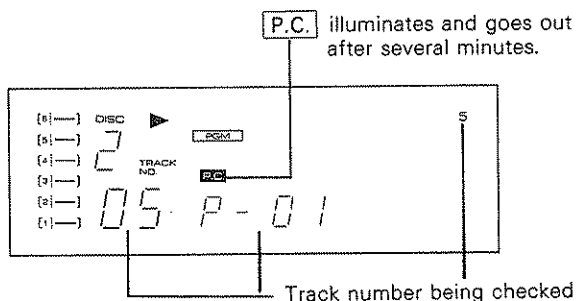

The display shows the program numbers being checked and then returns to 00:00 after several seconds.

### Example of when a program is changed

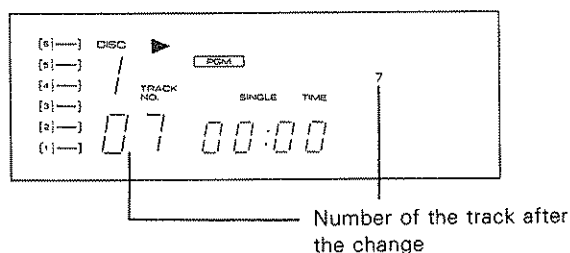

## ■ Checking a program

Press the CHECK key to confirm program contents.

- Each time you press the CHECK key, the display shows DISC No. and track number in programmed sequence.

## ■ Changing a program



1. Press the CHECK key until the display shows the track number that you wish to change.
2. While the **P.C.** is lit up, select your desired track by using the DISC SELECTOR key and the numeric keys.
  - Track being played cannot be changed.

## ■ Playing a program

After completing the programming, press the PLAY/PAUSE key .

- The play indicator (▶) blinking while programming stops blinking and lights up continuously. Then your tracks are played as you programmed them.

## ■ Playing from a particular track of a program

1. Press the SKIP key  to advance to the next program.
2. Press the SKIP key  to go back to the previous program.
  - The play starts from the beginning of the selected track.
  - If you press the  key once during play, it starts from the beginning of that track.

## ■ Stopping programmed play

Press the STOP key .

- If you then press the PLAY/PAUSE key , the play starts once more from the beginning of the program.

## ■ Adding a track

During the program mode you can add programs to the end by selecting the appropriate track numbers using the DISC SELECTOR key and the numeric keys.

## ■ Erasing a program

Press the CLEAR key.

- To erase the program contents from the last one in order, press the CLEAR key each time.
- All program contents will be erased if you perform any of the following operations.
  - ① Pressing the P-MODE key and switching into the TRACK mode.
  - ② Pressing the EJECT key .
  - ③ If the player is stopped and you press the CLEAR key as many times as there are tracks on the program.
  - ④ Turning off the power.

# Repeated playing

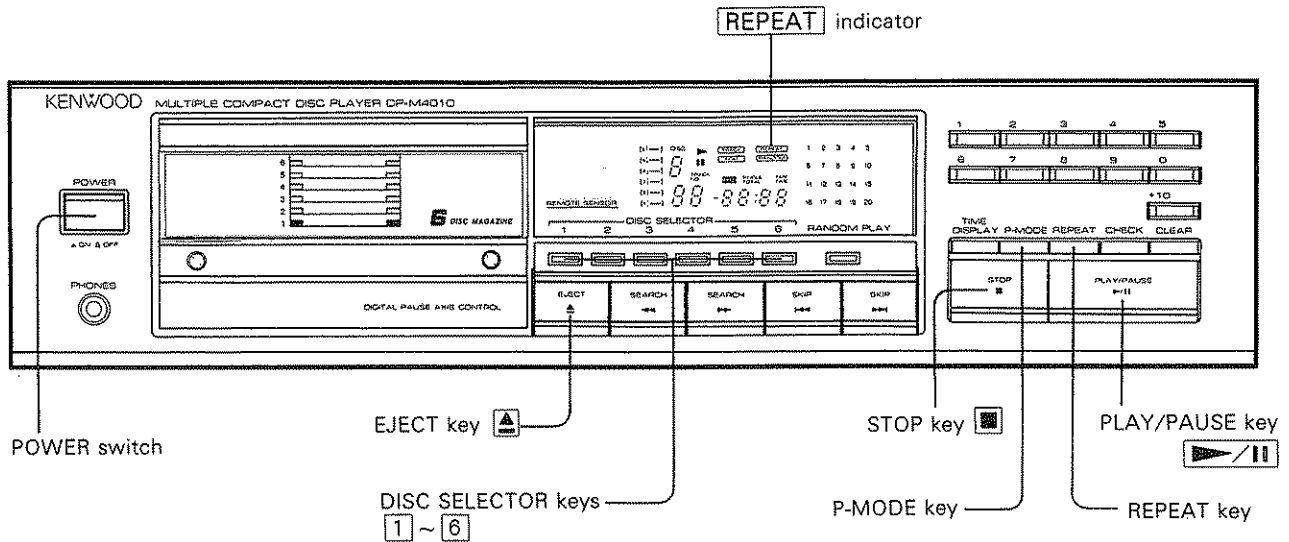

## When REPEAT key is pressed

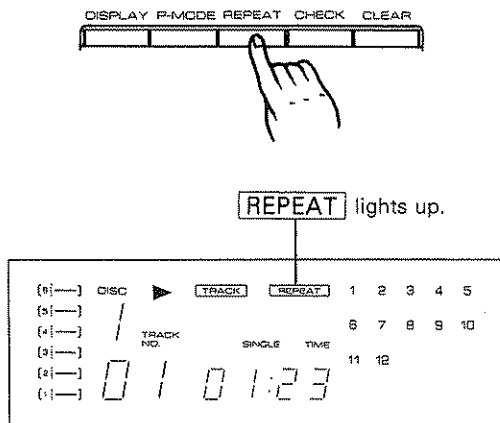

## ■ To repeat all the tracks

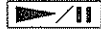
1. Press the REPEAT key.
2. Press the PLAY/PAUSE key  .
  - When in the track mode, tracks of all the disc are played repeatedly.
  - When in the program mode, all the tracks programmed are played repeatedly.
3. Press the REPEAT key again to cancel the repeated play.

## ■ To repeat play of a single track

1. Press the P-MODE key to put in the program mode.
2. Select the DISC No. you want to hear by DISC SELECTOR **1** ~ **6**.
3. Select the number of the single track you want to hear.
4. Press the REPEAT key.
5. Press the PLAY/PAUSE key  .
6. Press the REPEAT key again to cancel the repeated play.



# Random playing

This function allows for random selection of the tracks each time and continuous playing in any order. It is particularly useful for playing so that people will not get tired of the same sequence of music when hearing it for a long time.

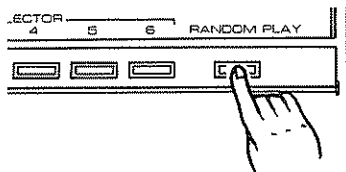
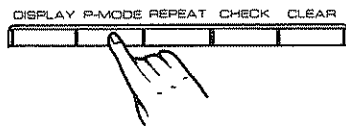
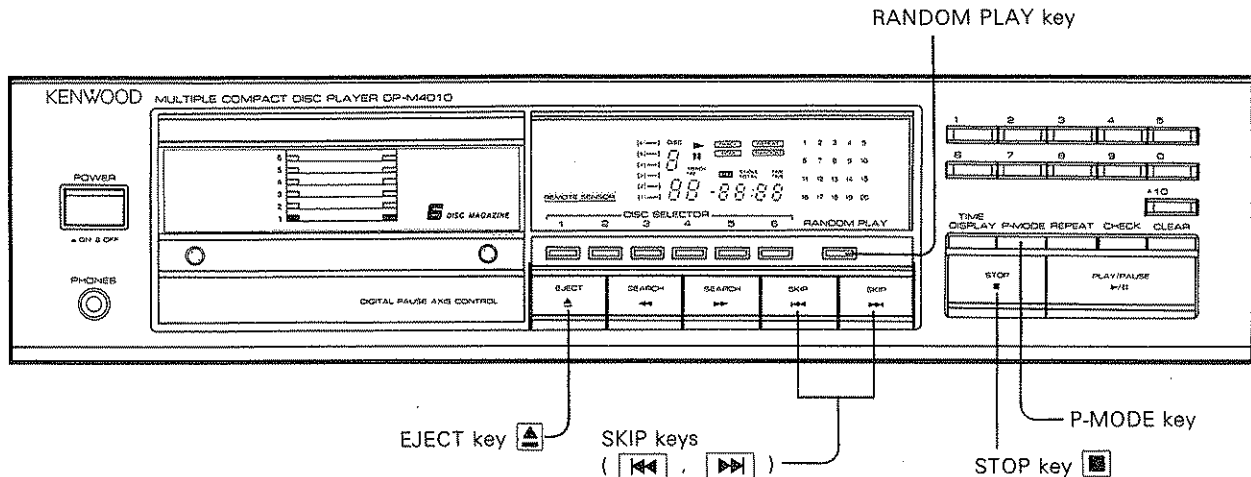

## Example of when 8th track of disc No.2

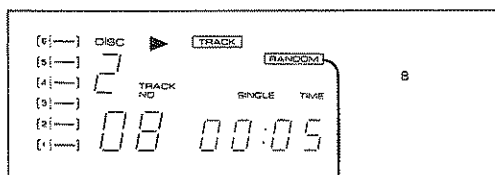

When the track is selected, **RANDOM** changes from blinking to lighting up and play starts.

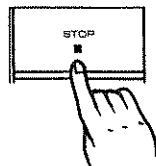

## ■ Random playing

### 1. Press the P-MODE key to switch to the track mode.

- **TRACK** lights up.

### 2. Press the RANDOM PLAY key.

- **RANDOM** blinks. When tracks are randomly selected, the disc No. and track number light up and the play starts.
- Press the SKIP key or to select another track.
- When the play of one track is completed, another track is again selected automatically and the play of that track starts.
- If you press RANDOM PLAY key when repeated playing is set (when **REPEAT** is lit up), random play takes priority and **REPEAT** is cancelled.

## ■ Stopping random play

Press the **STOP** key .

- The random play will be cancelled.

# Time display switching and timer playing

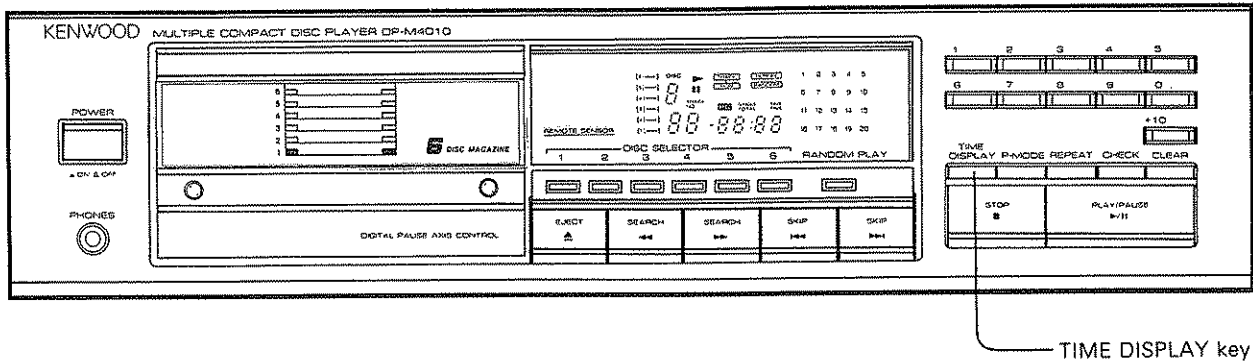

## ■ Changing time display

Each time you press the TIME DISPLAY key during play in any play mode, the time display changes in the order as below.

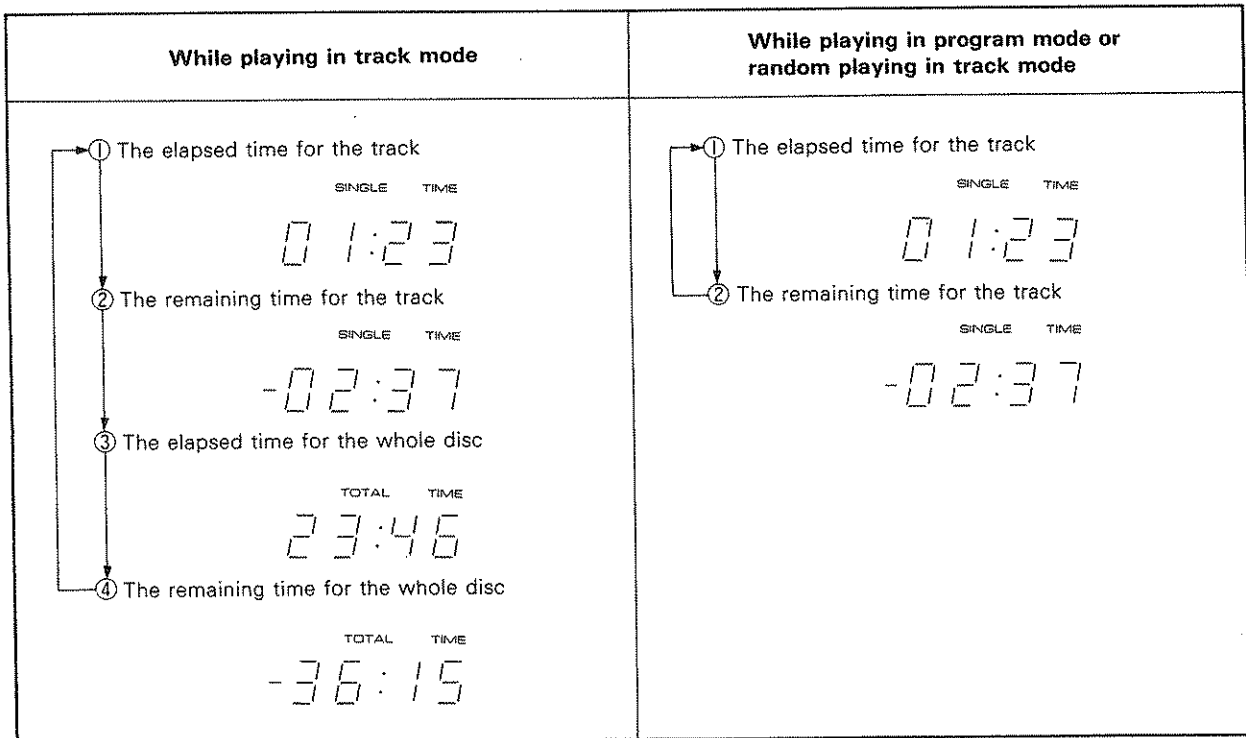

**Note:** This player stores time information for up to 29 tracks stored in the disc. When discs having 30 or more tracks recorded on them are played, the time may not be displayed. In such a case the display may show ---:--.

## ■ Timer playing

Plug the CD player's AC power plug into the audio timer. Load a disc. Leave the CD player's power switch turned on and set the audio timer to the desired time.

- Play will begin from the first track on the disc. (The track mode is selected automatically when the power turns on.)

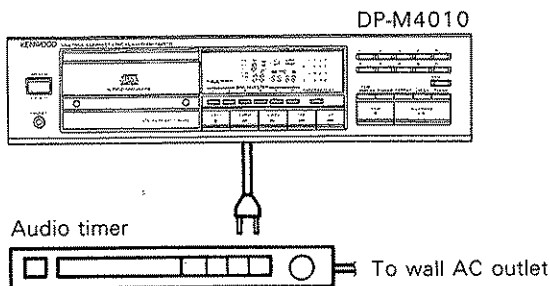



**Notes:**

1. Refer to the instruction manual for the timer.
2. Be careful of your amplifier volume setting when using an audio timer.
3. When operating the unit other than the CD player using an audio timer, be sure to remove the disc from the CD player.

# In case of difficulty

What appears to be a malfunction may not always be serious. Firstly, check the following items before consulting the service personnel.

Symptom	Cause	Remedy
<b>No power is applied with the POWER switch ON.</b>	<ol style="list-style-type: none"> <li>1. Power plug is loosely connected.</li> <li>2. With the power plug connected to the linking power socket of an amplifier, the power of the amplifier is turned off.</li> </ol>	<ol style="list-style-type: none"> <li>1. Insert the power plug firmly to the AC outlet.</li> <li>2. Turn the amplifier's power ON.</li> </ol>
<b>Disc is loaded, player does not play. (DISC indicator turns off.)</b>	<ol style="list-style-type: none"> <li>1. Disc is loaded upside down.</li> <li>2. Disc is dirty.</li> <li>3. Disc is cracked.</li> <li>4. Condensation occurred on the optical lens unit.</li> </ol>	<ol style="list-style-type: none"> <li>1. Load the disc again with its label side up.</li> <li>2. Wipe off the dust on the surface of the disc referring to "Cleaning of compact disc."</li> <li>3. Replace the disc with a new one.</li> <li>4. Leave the player for about 1 hour so that the condensation is removed.</li> </ol>
<b>No sound.</b>	<ol style="list-style-type: none"> <li>1. Disc is not loaded in the magazine.</li> <li>2. Play mode is not entered. (The play/pause indicator is not lit.)</li> <li>3. Disc is too dirty.</li> <li>4. Disc is cracked.</li> <li>5. The connection cords are inserted loosely.</li> </ol>	<ol style="list-style-type: none"> <li>1. Load a disc and press the PLAY/PAUSE key .</li> <li>2. Press the PLAY/PAUSE key .</li> <li>3. Wipe off the dust on the disc surface referring to "Cleaning of compact disc".</li> <li>4. Replace the disc with a new one.</li> <li>5. Connect all connection cords firmly.</li> </ol>
<b>Music is interrupted. (Sound is skipped.)</b>	<ol style="list-style-type: none"> <li>1. Disc is too dirty.</li> <li>2. Disc is cracked.</li> <li>3. Oscillation is applied to this unit.</li> </ol>	<ol style="list-style-type: none"> <li>1. Wipe off the dust on the disc surface referring to "Cleaning of compact disc".</li> <li>2. Replace the disc with a new one.</li> <li>3. Try selecting a place where no strong vibration occur by changing the installation place, etc.</li> </ol>
<b>Play starts when POWER is turned ON.</b>	If the disc is loaded, this player will play from the beginning of the first tune when the power is turned ON.	If automatic play is not required, remove the magazine from the player before turning the power OFF.

