

SANTO 86378-KG



Electronic Refrigerator/Freezer

Operating Instructions

Dear customer,

Before placing your new refrigerator/freezer into operation please read these operating instructions carefully. They contain important information for safe use, for installation and for care of the appliance.

Please keep these operating instructions for future reference. Pass them on to possible new owners of the appliance.



Notes which are important for your safety or for the proper functioning of the appliance are stressed with a warning triangle and/or with signal words (**Warning!**, **Caution!**, **Important!**). Please observe the following carefully.



1. This symbol and numbered instructions guide you step by step in the operation of the appliance.

2.



Supplementary information regarding operation and practical uses of the appliance appear after this symbol.



Tips and notes concerning economical and environmentally sound use of the appliance are marked with the cloverleaf.

Explanations of the technical terminology used in the operating instructions can be found at the end in the section "Technical Terminology".

The operating instructions contain instructions for the correction of possible malfunctions by the user in the section "What to do if ...". If these instructions should not be sufficient, please contact your local AEG Service Force Centre.

Printed on paper manufactured with environmentally sound processes.
he who thinks ecologically acts accordingly ...

Contents

Important Safety Instructions	5
Environmental Information	7
Appliance Transport	7
Before Use	8
Packaging	8
Fitting the Door Handles	9
Installation	10
Installation Location	10
The refrigerator/freezer needs ventilation	11
Appliance Alignment	11
Electrical Connection	12
Carbon filter	13
Reversing The Door	13
Appliance Description	14
View of Appliance	14
Freezer tray	15
Cold Accumulation Block	15
Control panel	16
Temperature setting buttons	16
Temperature Displays	17
RESET button	17
MODE button	18
Text display	18
Prior to Initial Start-Up	19
Initial Start-Up	20
Temperature Adjustment	20
Operating modes	22
SHOPPING	22
FROSTMATIC	22
COOLMATIC	23
FROSTMATIC and COOLMATIC	23
HOLIDAY	24
Switching the Appliance Off	24

Control and Information Systems	26
Power cut warning	26
"Open door" warning	26
Temperature warning	27
Function Errors	28
Opening the Freezer Compartment Door	28
Interior Accessories	29
Storage Shelves	29
Variable Inner Door	29
LONGFRESH 0 °C cold zone	29
Quick Chill Shelf	30
Bottle- and Can Holder	30
Dismantling of the Bottle- and Can Holder	30
Quick chill	31
Bottle Holder	31
Correct storage	32
Freezing	35
Frozen Storage	36
Storage Goods Symbols/Freezing Calendar	37
Preparation of Ice Cubes	37
Defrosting	37
Maintenance and Cleaning	39
Internal Cleaning	39
External Cleaning	40
Replacing the light bulb	41
Hints and Tips	42
Normal Operating Sounds	42
Food Storage	42
Energy Saving Advice	42
What to do if	43
Regulations, Standards, Guidelines	44
Technical Terminology	45
Guarantee Conditions	46
Service & Spare Parts	47



Important Safety Instructions

These warnings are provided in the interests of your safety. Ensure that you understand them all before installing or using this appliance. Your safety is of paramount importance. If you are unsure about any of the meanings of these warnings contact the Customer Care Department.

Prior to Installation

- Check the refrigerator/freezer for transport damage. Under no circumstances should a damaged appliance be installed! In the event of damage, please contact your retailer.

Installation

- This appliance is heavy. Care should be taken when moving it.
- It is dangerous to alter the specifications or attempt to modify this product in any way.
- Ensure that the appliance does not stand on the electrical supply cable. If the supply cable is damaged, it must be replaced by a cable available from your local Service Force Centre.
- Make sure that the power plug is not squashed or damaged by the back of the fridge/freezer. A damaged power plug may overheat and cause a fire.
- If the power plug socket is loose, do not insert the power plug. There is a risk of electric shock or fire.
- Any electrical work required to install this appliance should be carried out by a qualified electrician or competent person.
- Parts which heat up should not be exposed. Whenever possible, the back of the appliance should be close to a wall, but leaving the required distance for ventilation, as stated in the installation instructions.
- The appliance should be left for 2 hours after installation before it is turned on, in order to allow the refrigerant to settle.

Refrigerant

The refrigerant isobutane (R600a) is contained within the refrigerant circuit of the appliance, a natural gas with a high level of environmental compatibility, which is nevertheless flammable.

- During transportation and installation of the appliance, be certain that none of the components of the refrigerant circuit become damaged.

- If the refrigerant circuit should become damaged:
 - avoid open flames and sources of ignition;
 - thoroughly ventilate the room in which the appliance is situated.

Child Safety

- Do not allow children to tamper with the controls or play with the product. Inform children of the possible dangers and instruct them in the correct use of the appliance.
- Keep packaging material away from children! (There is a risk of suffocation!)

During Use

- This appliance is designed for domestic use only, specifically for the storage of edible foodstuffs only. It is not intended for commercial or industrial use
- Containers with flammable gases or liquids can leak at low temperatures. Do not store any containers with flammable materials such as, spray cans, fire extinguisher refill cartridges etc in the freezer.
- Frozen food should not be refrozen once it has thawed out.
- Do not place carbonated or fizzy drinks in the freezer.
- Ice lollies can cause 'frost/freezer burns' if consumed straight from the freezer compartment. Inform children of this danger.
- Do not remove items from the freezer compartment if your hands are damp/wet, as this could cause skin abrasions or frost/freezer burns.
- Bottles and cans must not be placed in the freezer. They can burst when the contents freeze.
- Manufacturers' recommended storage times should be adhered to. Refer to relevant instructions.

Maintenance and Cleaning

- Before cleaning, always switch off the appliance and disconnect from the electrical supply.
- When unplugging always pull the plug from the mains socket, do not pull on the cable. Damage to the cord may cause a short circuit, fire and/or electric shock.

Servicing

- This product should be serviced by an authorised engineer and only genuine spare parts should be used.
- Under no circumstances should you attempt to repair the appliance yourself. Repairs carried out by inexperienced persons may cause injury or serious malfunctioning.

Contact your local AEG Service Force Centre.

Environmental Information

Packaging

All transit packaging materials are environmentally compatible and can be reused. Wood is un-treated. The plastics can be recycled and are identified as follows:

>PE< for polyethylene, e.g. the outer covering and the bags in the interior.

>PS< for polystyrene foam, e.g. the pads, which are pure hydrocarbon compounds and can be recycled.

The carton parts are made from recycled paper. Please dispose of the packaging with due care for the environment.

Old Appliances

When disposing of your old appliance:

Make the appliance unusable by cutting off the cable and remove any door catches to ensure small children cannot be trapped inside.

Help to keep your country tidy - use an authorised disposal site.

Appliance Transport

Two persons are required to transport the appliance. Two handles are provided on the back of the appliance at the top to enable a better hold. Before transporting, the plinth cover must be removed to prevent damage.

-  1. To remove the plinth cover from the stops, tilt downwards and then pull forwards.

Important: Do not damage door contact (if present)

2. Grip the appliance with the recessed handles positioned as in the drawing, and transport the appliance.

3. In order to push the appliance into its final position, press carefully at the top of the door and tip the appliance back slightly. The weight is thus transferred to the back wheels and the appliance can be easily pushed.

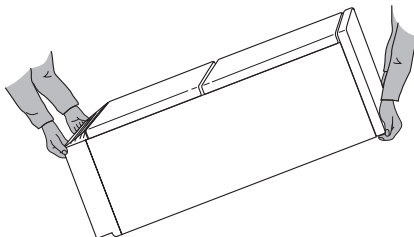
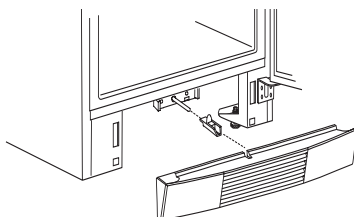

4. When the appliance is standing in the desired place, attach the plinth cover. Make sure that the door contact (if present) is not damaged and that it engages in the corresponding aperture in the plinth cover.

Before Use

Packaging

1. Remove all adhesive tape and packaging from the interior of the appliance.

i Any remnants of adhesive can be removed with white spirit.

2. Remove the transport protection pieces and pull off the adhesive tape.

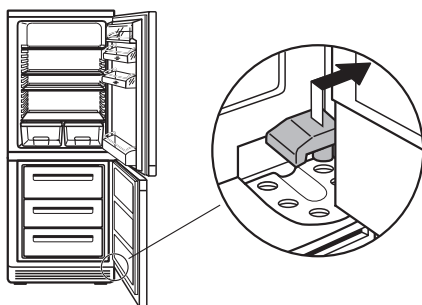
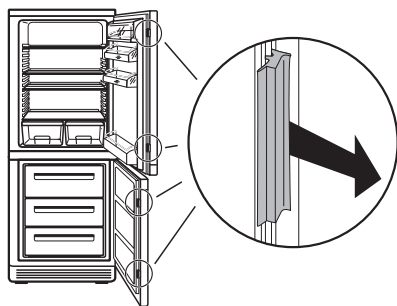

3. Wash the inside of the appliance with lukewarm water with a little bicarbonate of soda added (5 ml to 0.5 litre of water). Do not use soap or detergent as the smell may linger. Dry the appliance thoroughly.

Remove the transport fittings from the storage shelves:

4. Slide the fittings securing the shelf forward to the thicker section on the edge of the storage shelf.
5. Take hold of the storage shelf at the back and together with the fittings slide the storage shelf far enough forward so that it can be hinged downwards and the fittings can be removed from the guides.

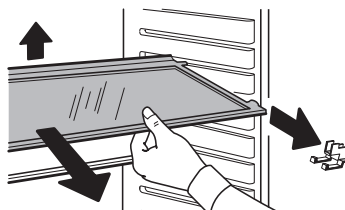
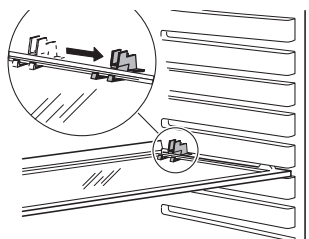

Fitting the Door Handles

To keep the amount of packaging down and to reduce the size for transporting, the door handles are not mounted when the appliance is delivered.



Take care! Do not tighten screws too tightly (max. 2 Nm), the door handles could be damaged.

The handles are packed separately on the padding in front of the door, the brackets and screws inside the appliance.

To mount, lay the appliance carefully on its back, if necessary. Use a piece of padding or a blanket as protection under the appliance.



1. Screw the top door bracket to the door handle (1). Mount the bottom door bracket to the bottom of the door (2).

Important: Ensure door handle is correctly positioned

2. Mount top door bracket on the top of the door (3) and screw handle to bottom door bracket (4).

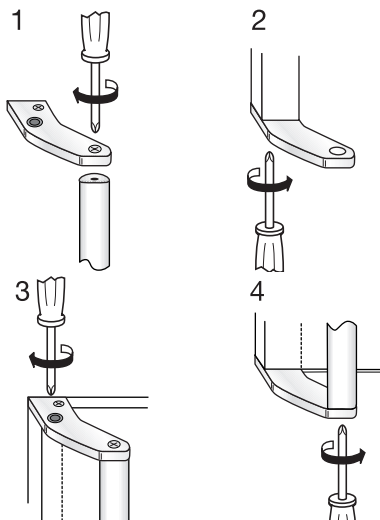

Installation

Installation Location

The appliance should be installed in a well ventilated, dry room.

Energy use and efficient performance of the appliance is affected by the ambient temperature.

The appliance should therefore

- not be exposed to direct sunlight;
- not be installed next to radiators, cookers or other sources of heat;
- only be installed at a location whose ambient temperature corresponds to the climate classification, for which the appliance is designed.

The climate classification can be found on the rating plate, which is located at the left on the inside of the appliance.

The following table shows which ambient temperature is correct for each climate classification:

Climate classification	for an ambient temperature of
SN	+10 to +32 °C
N	+16 to +32 °C
ST	+18 to +38 °C
T	+18 to +43 °C

If installation next to a source of heat is unavoidable, the following minimum clearances must be maintained at the sides of the appliance:

- for electric cookers 3 cm;
- for oil and coal fired ranges 30 cm.

If these clearances cannot be maintained a heat insulating pad is required between the cooker and the refrigeration appliance.

The refrigerator/freezer needs ventilation

Air is fed under the door through the vent slots in the base and is exhausted upwards along the back wall. To ensure proper air circulation never cover or alter the vent openings.

Important! If the appliance is installed under a hanging cabinet, a clearance of at least 10 cm between the top of the appliance and the cabinet above it must be maintained.

Please check whether, after installing your appliance and especially after reversing the door, the door seal seals tightly. A badly fitting door seal may lead to heavy frosting and a higher power consumption (see also "What to do if ...").

1. Remove the two wall spacers from the appliance accessories pack and, in accordance with the illustrations, fix them at the top of the rear of the appliance so that the distance from the wall required for the necessary ventilation is ensured.

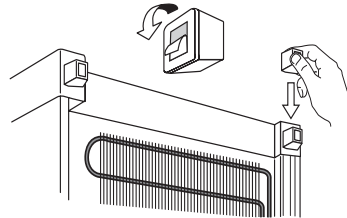
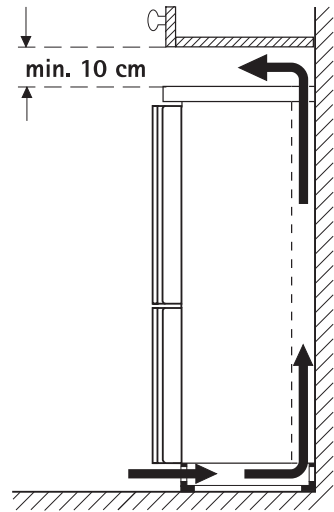

Appliance Alignment

The appliance must stand on a firm horizontal surface.

1. Please level out unevennesses in the floor by screwing the two adjustable front feet in or out using the 13 mm spanner supplied. To do this remove the plinth panel (see chapter "Transporting the appliance")

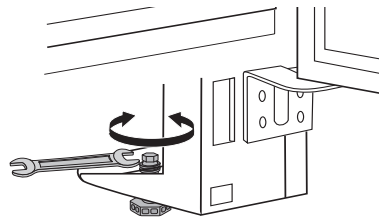

Electrical Connection

Any electrical work required to install this appliance should be carried out by a qualified electrician or competent person.



WARNING – THIS APPLIANCE MUST BE EARTHED

The manufacturer declines any liability should these safety measures not be observed.

Before switching on, make sure the electricity supply voltage is the same as that indicated on the appliance rating plate. The rating plate is inside, on the left.

The appliance is supplied with a 13 amp plug fitted. In the event of having to change the fuse in the plug supplied, a 13 amp ASTA approved (BS 1362) fuse must be used.

Important

The wires in the mains lead are coloured in accordance with the following code:

Green and Yellow	Earth
Blue	Neutral
Brown	Live

As the colours of the wires in the mains lead of this appliance may not correspond with the coloured markings identifying the terminals in your plug, proceed as follows:

1. The wire coloured green and yellow must be connected to the terminal marked with the letter "E" or by the earth symbol \oplus or coloured green and yellow.
2. The wire coloured blue must be connected to the terminal "N" or coloured black.
3. The wire coloured brown must be connected to the terminal marked "L" or coloured red.
4. Upon completion there must be no cut, or stray strands of wire present and the cord clamp must be secure over the outer sheath.

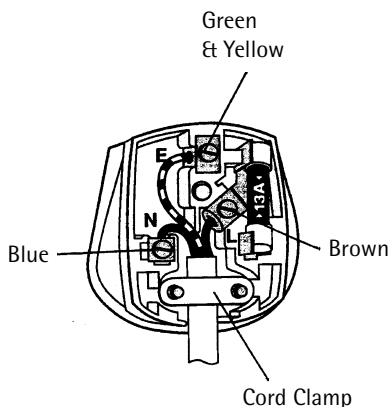

Warning! A cut-off plug inserted into a 13 amp socket is a serious safety (shock) hazard. Ensure that the cut-off plug is disposed of safely.

Carbon filter

There is a active carbon filter in the rear wall of the fridge section. The carbon filter cleans the air in the fridge section and in the LONGFRESH 0°C cold section by binding unpleasant smells.

Tip: The active carbon filter is a part subject to wear and is not covered by the warranty.

Inserting and changing the active carbon filter:

When the fridge is delivered, the carbon filter is packed in a plastic bag to ensure a long life. Before using the appliance for the first time, the carbon filter must be inserted behind the air discharge grill.

With the fridge operating normally, the carbon filter should be changed once a year to ensure optimum function.

New carbon filters can be obtained from specialist dealers or from the customer care department.

 1. To open the grill, press the lever on the right of the grill (1) and open the grill forwards (2).

2. To change the old carbon filter, pull it from the runners (3).

3. Insert the new carbon filter into the runners of the grill (3) and press the grill closed until it snaps into place.



Take care when handling the filter to prevent dislodging carbon particles.

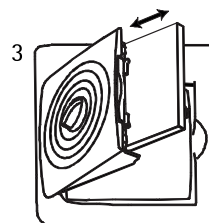
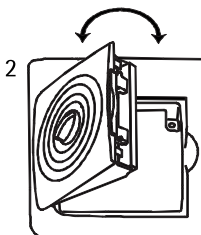
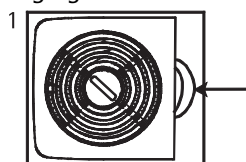

Reversing The Door

The door hinges can be changed if required to suit the location where the appliance is installed.

Important! Only a qualified technician should change the side on which the door is fixed. If this is necessary, please contact our Customer Services or your dealer.



Warning! Unplug from the mains, before reversing the door.

Appliance Description

View of Appliance

(various models)

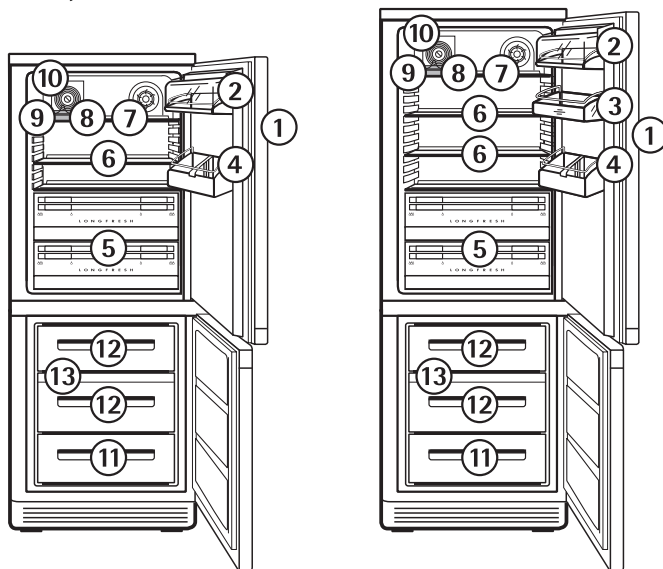

- ① Control panel
- ② Butter and cheese compartment with lid
- ③ Door storage compartments
- ④ Bottle compartment
- ⑤ LONGFRESH 0 °C cold zone
- ⑥ Shelves
- ⑦ Quick chill shelf
- ⑧ Bottle and can holder
- ⑨ Rating plate
- ⑩ Air discharge grill with regulator
- ⑪ Freezer drawer (only for storage). When defrosting the bottom drawer also serves as a water collecting vessel
- ⑫ Freezer drawer (for storage and freezing)
- ⑬ Freezer tray

Freezer tray

In the freezer section there is a freezer tray in the second drawer from the top. It can be used in both the top drawer and the second drawer from the top.

Berries and vegetables, for example, can be pre-frozen on the freezer tray.



Advantage: The berries are not squeezed and maintain their natural form. The frozen berries can then be stored in compartments or drawers packaged in individual portions.

Cold Accumulation Block

A cold accumulation block is enclosed with the appliance.



In the event of power failure or a malfunction of the appliance, the cold accumulation block will increase the hold over period by several hours. The cold accumulation block cools best if it is placed in the top drawer at the front on the frozen food. If the freezer section is only partially filled, pack the frozen food together as tightly as possible, so that in the event of a power cut the cold remains in the frozen food for longer.

When freezing food, place the cold accumulation block on the already frozen food to prevent defrosting due to the warmth of the food that is being frozen.

When defrosting the appliance place the cold accumulation block on top of the frozen food to keep it cold.

The block may also be used in a cool bag to keep the temperature of food down during transportation.

Refer to the section "Prior to Initial Start-Up" regarding the freezing of the cold accumulation block.

Control panel

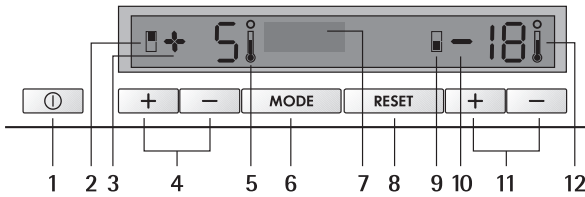

- 1 ON/OFF button
- 2 Fridge section indicator
- 3 Temperature indicator for fridge section (not for LONGFRESH 0 °C cold section)
- 4 Buttons for setting temperature for fridge section
- 5 Thermometer indicator for fridge section (with COOLMATIC)
- 6 MODE button for setting the operating mode
- 7 Text display
- 8 RESET button
- 9 Freezer section indicator
- 10 Temperature indicator for freezer section
- 11 Buttons for setting temperature for freezer section
- 12 Thermometer indicator for freezer section (with FROSTMATIC)

Temperature setting buttons



The temperature is adjusted using the „+“ (WARMER) and „-“ (COLDER) buttons.

These buttons are connected to the temperature display.

- The temperature display is switched over from the display of the ACTUAL temperature (Temperature display is illuminated) to the display of the DESIRED temperature (Temperature display flashes) by pressing one of the two buttons, „+“ (WARMER) or „-“ (COLDER).
- Each time one of the two buttons is pressed again the DESIRED temperature is adjusted by 1 °C.
- If neither button is pressed, the temperature display automatically switches back after a short period (approx. 5 sec.) to the display of the ACTUAL temperature.

DESIRED temperature means:

The temperature that has been selected for inside the fridge or the freezer compartment. The DESIRED temperature is indicated by flashing numbers.

ACTUAL temperature means:

The temperature display indicates the current temperature inside the fridge or the freezer compartment. The ACTUAL temperature is indicated with static illuminated numbers.

- i** Once the COOLMATIC- or the FROSTMATIC function has been switched on the DESIRED temperature that was set originally for the fridge or the freezer cannot be changed.

Temperature Displays



The temperature displays shows several types of information.

- In normal operation the average temperature in the fridge section is displayed (ACTUAL temperature). The variations in temperature in the whole fridge section are small.
- In the freezer section the warmest temperature is displayed (ACTUAL temperature). When fully filled, the warmest zone is normally located at the top in the front area of the freezer section. Depending upon how the section is filled, the temperatures are lower in other areas of the freezer section.
- While the temperature is being set, the currently set fridge and freezer section temperatures flash in the display (DESIRED temperature).

Tip: When changing the temperature setting wait about 24 hours until the temperature display has stabilised.

- When there is a temperature warning for the freezer compartment, if the RESET button is activated, the temperature display will show for 5 seconds the warmest temperature the frozen food has reached.
- If there is a fault in the appliance the temperature display shows:
 - a square or a letter in the temperature display of the fridge for a fault in the fridge,
 - a square or a letter in the temperature display of the freezer for a fault in the freezer.

RESET button



With the RESET button, the acoustic warning signal can be switched off, e.g. the "Open Door" warning when sorting in or out, the food to be chilled or frozen.

When there is a temperature warning for the freezer compartment, if the RESET button is activated, the temperature display will show for 5 seconds the warmest temperature the frozen food has reached.



MODE button



Different operating modes can be set using the MODE button.

The following operating modes can be selected:

- SHOPPING: Fridge temperature value 3 °C for 6 hours, cooling for freezer section runs for 1 hour in continuous operation.
- FROSTMATIC: Cooling for the freezer section runs for 52 hours in continuous operation.
- COOLMATIC: Fridge temperature value 3 °C for 6 hours.
- FROSTMATIC and COOLMATIC:
Cooling for freezer section runs for 52 hours in continuous operation, fridge temperature value 3 °C for 6 hours.
- HOLIDAY: Fridge temperature value 14 °C.
- : Normal operation according to the required temperatures set.

-  1. Press MODE button once. In the display the operating mode SHOPPING will flash.
 2. After approx. 4 seconds the display stops flashing, the operating mode SHOPPING is set.
 3. If another operating mode is to be set, before 4 seconds have elapsed, press the MODE button repeatedly until the desired mode is shown in the display. After approx. 4 seconds have elapsed, the display stops flashing, the operating mode is set. If the MODE button is pressed again, the next operating mode appears in the display.
-  To return to normal operation, press the MODE button repeatedly until no words appear in the display (" ").

Text display

SHOPPING The names of the various operating modes that can be set with the MODE button and the words indicating an alarm, power cut or electrical fault appear in the text display.

- Operating modes: SHOPPING, FROSTMATIC, COOLMATIC, FROSTMATIC and COOLMATIC, HOLIDAY, empty field when operating normally.
- Alarm: DOOR OPEN when the doors of the appliance have been open for too long, TEMPERATURE when there is a temperature warning
- After a power cut: POWER displayed
- Electrical fault: SERVICE displayed





Prior to Initial Start-Up



Before connecting the appliance to the mains and putting it into operation for the first time, leave the appliance to stand for 30 minutes if was transported upright. After transport on its side, the appliance must be left to stand for 2 hours before putting it into operation. This is necessary to allow the oil to flow back into the compressor. Otherwise the compressor may be damaged.

-  1. Please clean the appliance interior and all accessories prior to initial start-up (see section: "Maintenance and Cleaning").
2. The appliance must be correctly installed in accordance with the chapter "Installation" before it is put into operation for the first time. Care should be especially taken that the mains voltage and frequency available correspond with the appliance's rating plate.
3. Remove the cold accumulation block from the appliance.
4. Place the cold accumulation block into a drawer only after the optimal storage temperature of $-18\text{ }^{\circ}\text{C}$ has been reached, and allow to freeze.
5. After 24 hours place the cold accumulation block at the front of the upper drawer.
6. Re-freeze the thawed cold accumulation block in the same fashion, e.g. after cleaning the appliance.

Initial Start-Up

-  1. Insert plug into mains socket.
 2. Press and hold down the ON/OFF button. The temperature indicator and the back lighting light up, the appliance starts up. An alarm sounds, TEMPERATURE appears in the display and the back lighting flashes in red.
 3. Switch off alarm and red back lighting using RESET button. The TEMPERATURE indicator goes out, if the temperature in the appliance has gone below the warning temperature.
-  Temperature settings set in the factory: +5 °C for the fridge section, -18 °C for the freezer section.
4. Set the refrigerator to the desired temperature (see section: "Temperature Adjustment").
-  Goods to be refrigerated can be loaded shortly after switching on, because the storage temperature in the refrigerator is quickly reached. When the freezer section is operating and the fridge section is switched off, the latter can be switched on by pressing either of the fridge section buttons "+" or "-".
5. Set the freezer temperature to -18 °C or colder (see section: "Temperature Adjustment").
-  Do not load freezer with goods until a temperature of -18 °C has been reached, or until the red warning indicator light has gone out.

Temperature Adjustment

With the individual temperature setting buttons the desired temperatures in the refrigerator and in the freezer compartment can be adjusted independently of one another.

-  In the LONGFRESH 0 °C cold zone the temperature is automatically controlled. It remains constant at about 0 °C, no setting is required. **Note:** our appliance is equipped with a dynamic circulating air cooling function for the fridge section and the LONGFRESH 0 °C cold section. Because of this different fan noises can be discerned. This is normal, there is no fault or defect.

1. Press either the „+“ (WARMER) or „-“ (COLDER) button.
The temperature display switches over and the DESIRED temperature currently set flashes on the temperature display.
 2. To adjust to a warmer temperature, press the „+“ (WARMER) button. To adjust to a colder temperature, press the „-“ (COLDER) button. The changed setting is immediately displayed on the temperature display. Each time the button is pressed the temperature is adjusted by 1 °C.
Adjustable temperature range for the freezer compartment:
-15 °C to -24 °C.
Adjustable temperature range for the refrigerator compartment:
+3 °C to +8 °C, (Holiday mode: +14 °C)
 -  3. For the fridge section +5 °C and for the freezer section -18 °C are considered sufficiently cold storage temperatures.
3. Once the required temperature has been set, after a short period (approx. 5 sec.) the temperature display will change and again indicate the current ACTUAL temperature inside the fridge or freezer compartment. The display changes from flashing to illuminated numbers.
The display lighting switches itself on when any button is touched. If no button is pressed, the display lighting switches itself off after approx. 1 minute.
- Important!** Please check regularly on the warning display and on the temperature display that the storage temperature is being maintained.
- Tip:**
The appliance setting cannot be changed when the mains plug is pulled out or there is no power supply.
When reconnected to the mains supply, the appliance takes on the state it had at the time of the interruption to the power supply.

Operating modes

Using the MODE button different operating modes can be selected. The operating modes are automatically switched off after a corresponding period, but can also be manually ended each time. To do this, press the MODE button repeatedly until there are no longer any words appearing in the display. After the operating modes have been completed, the appliance continues to run with the previously set desired temperatures.

 As long as the figures in the temperature display are still flashing after the desired temperature has been set, no operating mode can be set with the MODE button.

SHOPPING

SHOPPING The SHOPPING function is suitable for quickly cooling larger quantities of refrigerated foods in the fridge section, as well as for smaller amounts of frozen foods in the freezer section, e. g. after a big shop. This automatically sets a desired temperature of +3 °C for the fridge section for 6 hours. Cooling for the freezer section runs for 1 hour in continuous operation.

-  1. Press the MODE button repeatedly until SHOPPING is flashing in the display. After approx. 4 seconds the operating mode SHOPPING is activated, the SHOPPING indicator lights up. Both thermometer indicators in the display show a falling temperature column. The SHOPPING function is automatically switched off after 6 hours. The SHOPPING indicator will go out.

FROSTMATIC

FROSTMATIC The FROSTMATIC function provides for quick freezing of fresh food products, and at the same time protects previously stored goods against undesired warming in the freezer compartment. The cooling of the freezer section runs for about 52 hours in continuous operation.

-  1. Press the MODE button repeatedly until FROSTMATIC is flashing in the display.
After approx. 4 seconds the operating mode FROSTMATIC is activated, the FROSTMATIC indicator lights up. The thermometer indicator in the display for the freezer section shows a falling temperature column. The operating mode FROSTMATIC is automatically switched off depending on how the appliance is filled at the latest after approx. 52 hours. The FROSTMATIC indicator will go out.

COOLMATIC

COOLMATIC The COOLMATIC operating mode is suitable for quickly cooling larger quantities of refrigerated foods in the fridge section, e. g. drinks, salads for a party or wedding.

-  1. Press the MODE button repeatedly until COOLMATIC is flashing in the display.
After approx. 4 seconds the operating mode COOLMATIC is activated, the COOLMATIC indicator lights up. The thermometer indicator in the display for the fridge section shows a falling temperature column. The COOLMATIC function now provides for intensive cooling. A DESIRED temperature of +3 °C is automatically selected. The COOLMATIC function is ended automatically after a period of 6 hours. The originally selected DESIRED temperature is again valid. The temperature display shows the ACTUAL refrigerator temperature.

FROSTMATIC and COOLMATIC

When the FROSTMATIC and COOLMATIC functions are combined, a desired temperature of +3 °C is automatically set for the fridge section for 6 hours. Cooling for the freezer section runs for 52 hours in continuous operation.

-  1. Press the MODE button repeatedly until FROSTMATIC and COOLMATIC are flashing in the display at the same time.
After approx. 4 seconds the operating mode FROSTMATIC and COOLMATIC is activated, the FROSTMATIC und COOLMATIC indicators light up. Both thermometer indicators in the display show a falling temperature column.
The functions FROSTMATIC and COOLMATIC are automatically switched off: COOLMATIC after 6 hours, FROSTMATIC after 52 hours at the latest. The indicators go out accordingly.

HOLIDAY

In the operating mode HOLIDAY (holiday setting) the desired temperature value for the fridge section is +14 °C. In the holiday mode it is therefore possible to leave the door of the empty refrigerator closed during periods of extended absence. Advantage: Unintentional closing of the door, or accidental closing of the door by persons who have access to your home during your absence, is no longer possible. Without the holiday mode leaving the door closed would lead to the accumulation of odours and mould.

After emptying and cleaning the appliance, proceed as follows:

1. To switch on the holiday setting, press the MODE button repeatedly until HOLIDAY is flashing in the display.

After approx. 4 seconds the operating mode HOLIDAY is activated, HOLIDAY lights up.

Important! Do not store any goods in the refrigerator when the holiday mode is in operation. The temperature is regulated at about +14 °C when the holiday mode is in operation. This is too warm for food products.

If, while you are away, the room temperature could fall below 15 °C for a long period, the fridge should not be operated in the operating mode HOLIDAY, but switched off and the door opened.

-  To return to normal operation, press the MODE button repeatedly until there are no longer any words appearing in the display.

Switching the Appliance Off

-  Refrigerator and freezer compartments can be switched off independently of one another.

1. To switch the entire appliance off, press and hold down the ON/OFF button. In both temperature displays there is a countdown from "3" to "1". After "1" is reached, "OF" is displayed briefly, then the fridge section and the freezer section are switched off. The temperature displays go out.

-  Before the countdown has been completed, the switch-off procedure can be cancelled by releasing the ON/OFF button.

Switching off fridge section when freezer section is switched on:

-  Press and hold the "+" and "-" buttons for the fridge section at the same time. There is a "countdown" from "3" to "1", then "OF" appears in the temperature display. The fridge section switches itself off.

 To switch the fridge section on again, press "+" or "-" button.

Switching off fridge section when freezer section is switched off:

-  1. Press and hold the "+" and "-" buttons for the fridge section at the same time. There is a "countdown" from "3" to "1", then "OF" appears in the temperature display. The fridge section or the whole appliance switches itself off.

 Before the countdown has been completed, the switch-off procedure can be cancelled by releasing the "+" and "-" buttons.

 When the fridge section is switched off, the only operating mode that can be activated while the freezer section is operating is FROSTMATIC.

Switching off freezer section when fridge switched on:

-  1. Press and hold down the "+" and the "-" buttons for the freezer section at the same time. In the temperature display for the freezer section there is a countdown from "3" to "1". Then "OF" appears in the temperature display. The freezer section switches itself off.

 To switch the freezer section on again, press "+" or "-" button.

Switching off freezer section when fridge switched off:

-  1. Press and hold down the "+" and the "-" buttons for the freezer section at the same time. There is a countdown from "3" to "1", then "OF" appears in the temperature display. The freezer section or the whole appliance switches itself off.

 The appliance is only completely disconnected from the electricity supply when the power plug has been removed from the power outlet.

If the appliance is not to be used for an extended period:

-  1. Switch appliance off by pressing and holding the ON/OFF button (see above).
- 2. Remove the mains plug or switch off.
- 3. Defrost freezer compartment and clean the appliance thoroughly (see section: "Maintenance and Cleaning").
- 4. Leave the doors open to avoid accumulation of odours.

Control and Information Systems

The control and information systems consist of temperature displays, an optical warning display and an acoustic warning.

The system warns:

- when there is a power cut;
- when the appliance doors are open
- if the temperature in the refrigerator or freezer compartment is too high;
- if there are functional faults with the appliance.

Power cut warning

After an interruption to the power supply, POWER is displayed in the display and the current Actual temperature is displayed again. The appliance continues to run with the previously selected settings. The POWER indicator goes out, as soon as any button is pressed.

"Open door" warning

When the fridge or freezer door is open, an alarm sounds and the indicator DOOR OPEN and red back lighting flash.

- when the freezer door is open, after about 1.5 minutes,
- when the fridge door is open, after about 5 minutes.

 1. If you need more time to put refrigerated or frozen food away or to re-arrange it, you can cancel the alarm and the flashing red light by pressing the RESET button.

If the doors are still open, the alarm starts again after 10 minutes (open fridge section door) or 3 minutes (open freezer section door).

2. Using the RESET button you can cancel the alarm and the flashing red light again for 10 minutes (open fridge section door) or 3 minutes (open freezer section door). If the doors are still open after that, the alarm starts again.
3. If the RESET button is pressed for a third time, the door alarm is switched off for good.

The DOOR OPEN indicator goes out when the doors are closed.

Temperature warning

For the fridge section:

An alarm sounds and the TEMPERATURE indicator and a red back light flash, as soon as the temperature in the fridge section rises above 12 °C.

If the temperature in the fridge section falls below 12 °C, the alarm automatically switches itself off. The TEMPERATURE indicator and the red back lighting continue to flash.

-  1. You can switch off the alarm and warning light with the RESET button. For 5 seconds the temperature display for the fridge section shows the warmest temperature that was reached in the fridge section during the temperature warning. After that the temperature display stops flashing and switches back to the current temperature in the fridge section. The TEMPERATURE indicator continues to flash, as long as there is a temperature warning.

For the freezer section:

An alarm sounds and the TEMPERATURE indicator and red back lighting flash, as soon as the temperature in the freezer section rises above -11 °C.

If the temperature in the freezer section falls back below -11 °C, the alarm automatically switches itself off. The TEMPERATURE indicator and the red back lighting continue to flash.

-  1. You can switch off the alarm and the red back lighting with the RESET button. For 5 seconds the temperature display for the freezer section shows the warmest temperature that was reached in the freezer section during the temperature warning. After that the temperature display stops flashing and switches back to the current temperature in the freezer section. The TEMPERATURE indicator continues to flash, as long as there is a temperature warning.

 If there is an interruption to the power supply during an alarm, when the appliance is reconnected to the supply, it starts with an acoustic and visual alarm.

If the possibility of partial or complete thawing exists, you should check the quality of the foods.

A rise in temperature may be caused by:

- frequent door opening for long periods of time;
- loading with large quantities of warm foods;
- high ambient temperature;
- an error with the appliance.

Function Errors

If the appliance's electronics recognise a technical problem that has to be remedied by the Customer Service Department, an alarm sounds and the SERVICE indicator appears back lit with a flashing red light.

The temperature display indicates:

- a square or a letter in the temperature display of the fridge for a fault in the fridge,
- a square or a letter in the temperature display of the freezer for a fault in the freezer.

1. Using the RESET button you can switch off the alarm and the flashing red light. The SERVICE indicator continues to be lit as long as there is an electrical malfunction.

Opening the Freezer Compartment Door

If the freezer compartment door is closed when the appliance is in operation, it is possible that it cannot be immediately opened again. A vacuum occurs in the freezer compartment which holds the door closed until pressure has been equalised. The door can be opened again after several minutes.

Interior Accessories

Storage Shelves

The storage shelves can be adjusted to various heights:

1. Pull the storage shelf forward until it can be tipped up or down and removed.
2. To insert at a different height use the same procedure in reverse.

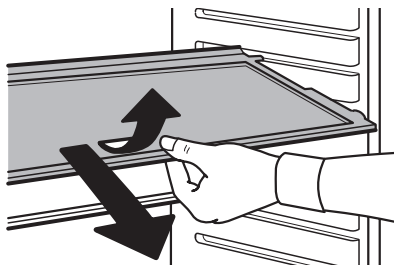

Variable Inner Door

The door compartments can be pulled up and removed, and inserted at other positions as needed.

LONGFRESH 0 °C cold zone

The LONGFRESH 0 °C cold zone consists of 2 drawers provided with slide controls to set the air moisture.

In the LONGFRESH 0 °C cold zone the temperature is automatically controlled. It remains constant at about 0 °C, no setting is required. The low storage temperature of around 0 °C and the air moisture that can be regulated result in optimum storage conditions for various foodstuffs.

Compared to the normal fridge zone, fresh food can be stored in the LONGFRESH 0 °C cold zone for longer while keeping the same quality. High levels of taste and freshness, vitamins and minerals are retained. Weight loss in fruit and vegetables is reduced. Nutrition levels in your food are higher as a result.

- i** The LONGFRESH 0 °C cold zone is also suitable for slowly defrosting frozen food. If you do this, the defrosted food can be kept in the LONGFRESH 0 °C cold zone for up to two days. To use the maximum fridge section space, you can take the drawers out of the appliance. The storage conditions then correspond to the "Dry" setting (only for packaged food).

Setting the air moisture

The two drawers can be used independently of one another with higher or lower air moisture according to the storage conditions required. The air moisture can be set with the aid of the slide control on the front of each drawer.

- Dry: a low relative air moisture is obtained when both controls are slid to position Δ , i.e. the air holes are fully opened.
- Moist: a high relative air moisture is obtained when both controls are slid to position W , i.e. the air holes are fully closed.

The air moisture in the drawers depends upon the moisture content of the food stored and upon how often the door is opened.

Quick Chill Shelf

The quick chill shelf can be placed in one of the upper grooves. To maintain the best performance the shelf should be placed in the second groove from the top.

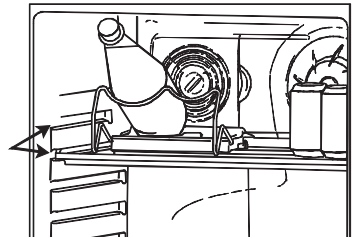

Bottle- and Can Holder

The side of the bottle- and can holder is moveable to enable a more flexible placement of cans and bottles in front of the air discharge grill. To allow the holder to be moved easier when moving sideways, press the shelf backwards. The bottle support can be pulled out when chilling larger bottles.

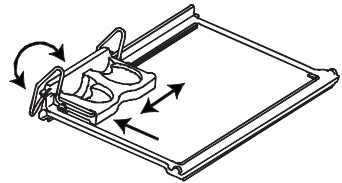

Dismantling of the Bottle- and Can Holder

1. Take out the quick chill shelf with holder from the cabinet.
2. To loosen the holder from the shelf, bend the hooks/brackets that surround the backside of the shelf.

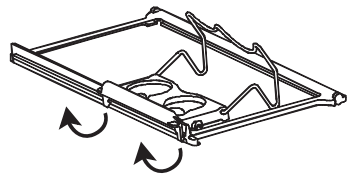

Quick chill

The quick chill function can be used for the fast cooling of drinks in cans or bottles in the fast cool storage tray or of larger amounts of room-temperature food.

Chilling of cans or bottles

Place cans or bottles in the holder on the fast cool storage tray in front of the air discharge grill. Set the regulator to maximum circulation and set the COOLMATIC function.

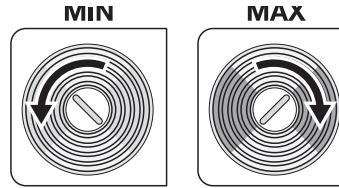

Chilling of food

Place the food in the fridge.

Open the regulator to maximum and set the COOLMATIC function.

When the drinks or the food is sufficiently cooled, turn off the COOLMATIC function. Set regulator to minimum opening.



When this function has been activated, forced air will chill the groceries, and the temperature in the cabinet reset to +3 °C. After 6 hours the COOLMATIC function is ended automatically. The yellow light goes out. Turn the air regulator to its minimum position.

Bottle Holder

Some models are equipped with a bottle holder in the bottle compartment. This is used to prevent individual bottles from falling over and can be slid sideways.

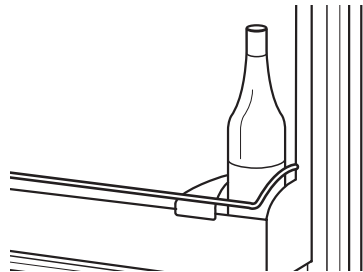

Correct storage

A fan provides for quick cooling of the food and an even temperature distribution in the fridge zone and in the LONGFRESH 0 °C cold zone.

Foods with different perishability can therefore be arranged on the shelves as you like, without having to take into account the different temperature zones which usually occur. The arrangement (see fig.) indicates possible ways of storing food.

In order to check the temperature on the shelves you can carry out the following test yourself:

1. Place a cup of water in the centre of the said shelf with a thermometer inside.
2. Leave the fridge door closed overnight and check the temperature first thing in the morning.
3. At this point the temperature should read no more than 5 °C; if it does, you need to adjust the temperature regulator to a colder setting.

For further information on keeping food cool and safe a guide published by the Ministry of Agriculture, Fisheries and Food is available and can be obtained free of charge by contacting:

Foodsense, London SE99 7TT. Tel: 0645 556000

Food that is sensitive to cold temperatures should not be stored in the LONGFRESH 0 °C cold zone:

- citrus and tropical fruits, such as pineapples, bananas, grapefruits, melons, mangoes, papayas, oranges, lemons, kiwi fruit.
- hard cheese, potatoes, vegetables that are sensitive to cold temperatures such as cucumbers, peppers, aubergines, avocados, half ripe tomatoes, beans, courgettes.



Important: Do not store any dripping wet fruit or vegetables in the LONGFRESH 0°C cold section

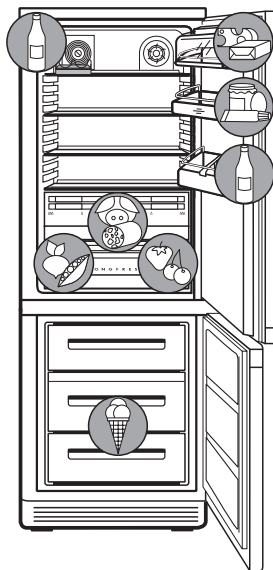

Guidelines for storage times

Some foods in the LONGFRESH 0 °C cold zone:

Dry storage:

Food	Storage period
Butter	up to 30 days
Cheese, soft	up to 30 days
Milk, fresh	up to 7 days
Sausage, sliced	up to 7 days
Fish	up to 4 days
Shellfish	up to 3 days
Poultry	up to 5 days
Pork larger joints cut into smaller pieces	up to 7 days up to 5 days
Beef, game	up to 7 days

Moist storage:

Vegetables, salad stuffs	Storage period
Artichokes	up to 21 days
Cauliflower	up to 21 days
Broccoli	up to 14 days
Iceberg lettuce, lamb's lettuce	up to 21 days
Peas	up to 10 days
Green cabbage	up to 14 days
Carrots	up to 150 days
Cabbage	up to 14 days
Leeks	up to 60 days
Mushrooms	up to 7 days
Radishes	up to 14 days
Asparagus	up to 7 days
Spinach	up to 7 days

Fruit	Storage period
Apricots	up to 14 days
Pears	up to 120 days
Blackberries	up to 8 days
Dates (fresh)	up to 60 days
Strawberries	up to 5 days
Blueberries	up to 14 days
Raspberries	up to 5 days
Cherries	up to 14 days
Peaches	up to 30 days
Plums	up to 21 days
Rhubarb	up to 21 days
Gooseberries	up to 21 days
Grapes	up to 21 days

Tips:

- When shopping always look for the freshest foods. Quality and freshness are crucial to how long food can be kept.
- Always store meat and fish wrapped and dry.
- Foodstuffs rich in protein spoil more quickly: Shellfish and crustaceans go off more quickly than fish and fish in turn goes off more quickly than meat. By storing them in the 0°C section, the storage period even for these foodstuffs can be increased by up to 3 times without loss of quality.
- All food that is stored in the LONGFRESH 0 °C cold zone should be removed from the drawers approx. 15 - 30 minutes before consumption. Aroma and taste develop at room temperature and the enjoyment of the food is increased.
- Food stored in the refrigerator compartment should always be covered or packed so that they do not dry out, lose their flavour, or transfer their flavour to any other refrigerated food. The following are suitable for packing:
 - polyethylene bags;
 - plastic containers with lids;
 - special plastic covers with rubber retainers;
 - aluminium foil.

To obtain the best performance from your refrigerator/freezer:

- Do not store warm food or evaporating liquids.
- Keep the time between buying chilled food and placing it in your freezer as short as possible.
- Do not push food together too much, try to allow air to circulate around each item.

Freezing

Except for the bottom drawer, which serves only for storage purposes, all compartments and drawers in the freezer compartment are suitable for freezing fresh food.

Warning!

- Before foods are frozen, the actual temperature in the freezer compartment must be $-18\text{ }^{\circ}\text{C}$ or colder.
- Please observe indicated freezing capacity on the rating plate. The freezing capacity represents the maximum amount of fresh goods that can be frozen within 24 hours. If you freeze goods on several days, one after the other, freeze amounts equal to $2/3$ to $3/4$ of the capacity indicated on the rating plate.
- When freezing large amounts of frozen food, place the frozen freezer block at the front of the middle drawer in the freezer section on the already frozen food.
- Thawed foods which have not been processed further (cooked into meals) may not under any circumstances be frozen a second time.

-  1. Place the packaged frozen foodstuffs in the bottom drawer. Pack together as tightly as possible, to prevent loss of coldness and place the freezer block on top.

Take care: Do not touch frozen foods with wet hands. Your hands could freeze onto them.

2. Before freezing, wrap up all foodstuffs to be frozen in airtight packaging, so that they do not dry out, do not lose their taste and there can be no transfer of taste to other frozen foods. Place the food to be frozen in the top drawer(s). Non-frozen goods must not touch already frozen goods, as otherwise the frozen goods can defrost.

-  When using the max. freezer capacity, set the operating mode FROSTMATIC for 24 hours before freezing – with smaller amounts 4 to 6 hours are sufficient.
The FROSTMATIC mode need not to be set for freezing of small quantities of up to 3 kg.



The appliance electronics automatically switch the FROSTMATIC operating mode off after a period of approx. 52 hours at the latest. You can also stop the FROSTMATIC operating mode manually by switching to normal operation.

Tips:

- The following are suited for the packaging of frozen goods:
 - freezer bags and polyethylene wraps;
 - plastic containers for frozen foods;
 - extra-thick aluminium foil
- The following are suited for sealing bags and wraps:
plastic clips, rubber bands or adhesive tape.
- Press air out of bags and wraps before sealing, because air encourages drying of frozen goods.
- Make flat packages, because these freeze more quickly.
- Do not fill plastic containers for frozen foods to the brim with liquid or paste-like goods, because liquids expand during freezing.

Frozen Storage

Warning! Before initial loading of the freezer compartment with previously frozen goods, the required storage temperature of $-18\text{ }^{\circ}\text{C}$ must be reached.

- Load freezer only with packaged frozen goods, so that they do not dry out or lose their flavour, and so that no flavour contamination of other frozen goods can occur.
- Please observe maximum storage times and expiry dates of frozen goods.
- If the freezer section is only half filled, pack the frozen food together as tightly as possible. This ensures that the cold is retained in the frozen food for longer in the event of a power cut.



When possible store frozen goods separately according to type in drawers.

Storage Goods Symbols/Freezing Calendar

- The symbols on the drawers show different types of frozen goods.



- The numbers indicate storage times in months for the appropriate types of frozen goods. Whether the upper or lower value of the indicated storage time is valid depends on the quality of the foods and pre-treating before freezing. The lower value applies to foods with high fat content.

Preparation of Ice Cubes

1. Fill ice cube tray 3/4 full with cold water and place in a drawer and allow to freeze.
 2. To remove the finished ice cubes twist the ice cube tray or hold under running water for a short time.
- Warning!** Do not, under any circumstances, free an ice tray which is frozen to the appliance with pointed or sharp edged objects. Use a spoon-handle or similar object.

Defrosting

Fridge zone and LONGFRESH 0 °C cold zone defrost automatically

The electronics start the defrosting cycle in the refrigerator every time the compressor stops.

The water collects in the discharge trough at the back wall of the refrigerator, and is fed through the discharge opening in the catch tray at the compressor where it is evaporated.

Freezer Compartment Defrosting

Moisture is precipitated in the form of white frost in the freezer compartment during operation and when the door is opened, especially in the middle at the top. Remove this white frost from time to time with a soft plastic scraper, e.g. a dough scraper. Do not under any circumstances use hard or pointed objects for this purpose.

The appliance should be defrosted when the thickness of the white frost has reached about 4 mm; but at least once a year in any case. A convenient time for defrosting is any time when the appliance is empty, or only minimally loaded.



Warning!

- Do not use electrical heating appliances or any other mechanical or artificial devices to speed up the defrosting process, with the exception of those recommended in these operating instructions.
- Do not use defrosting sprays, because they may be health endangering and/or contain substances damaging to plastics.



1. About 12 hours prior to defrosting set the operating mode to FROST-MATIC in order to build up sufficient chill reserve for the interruption in operation.

Caution! Do not touch frozen goods with wet hands. Hands can freeze to the goods.

2. Remove frozen goods, pack them in several layers of newspaper, cover them and store them in a cool place.
3. Switch off the appliance and remove plug from the mains, or disconnect from the electricity supply.
4. Remove all the drawers. Place the bottom drawer directly in front of the appliance to collect the water from defrosting. Take out the water drain spout from its resting position at the bottom of the freezer compartment and place it as shown.

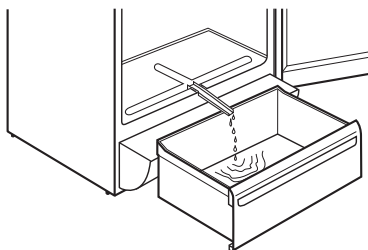

Tip: In order to speed up the defrosting process, place a pot of warm water in the freezer compartment. In addition, remove pieces of ice that break away before defrosting is complete.

5. After defrosting thoroughly clean the freezer interior, as well as interior accessories (see section: "Maintenance and Cleaning").

Maintenance and Cleaning

Before any maintenance or cleaning work is carried out **DISCONNECT** the appliance from the **ELECTRICITY** supply.



Warning!

- Do not use detergents, abrasive powders, highly perfumed cleaning products, wax polishes or cleaning products containing bleach or alcohol.
- Never clean the appliance with a steam cleaner. Moisture could accumulate in electrical components, danger of electrical shock! Hot vapours can lead to the damage of plastic parts.
- The appliance must be dry before it is placed back into service.

Attention!

- Ethereal oils and organic solvents can attack plastic parts, e. g.
 - lemon juice or the juice from orange peels;
 - butyric acid;
 - cleansers which contain acetic acid.Do not allow such substances to come into contact with appliance parts.
- Do not use any abrasive products.

Internal Cleaning



If the refrigerator only is to be cleaned, set the operating mode to FROSTMATIC several hours in advance, in order to build up sufficient chill reserve in the freezer compartment for the interruption in service. Do not open the freezer compartment door.



1. Set the operating mode to FROSTMATIC several hours in advance, in order to build up sufficient chill reserve in the frozen food for the interruption in service.

Caution! Do not touch frozen goods with wet hands. Hands can freeze to the goods.

2. Remove frozen food, wrap it in several layers of newspaper and store it, covered, in a cool place. Place the cold accumulation block on top of the frozen food to keep it cold.
3. Switch off the appliance and remove plug from the mains, or disconnect from the electricity supply.

4. Defrost the freezer compartment (see section: "Defrosting").
5. Clean the inside and accessories with warm water and bicarbonate of soda (5 ml to 0.5 litre of water).



The bottom shelf, which divides the fridge zone from the LONGFRESH 0 °C cold zone, can be removed for cleaning. To do this, pull the shelf straight out.

The cover over the bottom drawer can be removed for cleaning purposes. After cleaning, it must be returned to the previous position so that the function of the LONGFRESH 0 °C cold section can be retained.

6. Rinse and dry thoroughly.
7. Regularly check the door seals and wipe clean to ensure they are clean and free from debris.

External Cleaning



Warning!

- There are sharp edges on the underside of the product so care should be taken when cleaning.
- Do not use abrasive products



1. Wash the outer cabinet with warm soapy water.
2. Rinse and dry thoroughly.



Important: Do not use cleaning agents for stainless steel or other aggressive or abrasive cleaning agents. The protective coat of lacquer on the stainless steel surface can be damaged by these.

The coat of lacquer protects against finger prints and therefore additional cleaning agents and maintenance products are no longer required.



Accumulation of dust at the condenser increases energy consumption. For this reason carefully clean the condenser at the back of the appliance once a year with a soft brush or a vacuum cleaner.

3. After everything is dry place appliance back into service.

Replacing the light bulb

i For safety reasons the interior lighting switches off after 7 minutes when the door is open. It switches on again the next time the door is opened.

! **Warning!** Danger of electrical shock! Before replacing the light bulb switch off the appliance and remove the mains plug.

Light bulb specifications: 220-240 V, max. 25 W, fitting: E 14

- 1.** To switch the appliance off press and hold the ON/OFF button.
- 2.** Unplug the mains plug.
- 3.** To change the light bulb, undo the cross head screw and remove the light bulb cover downwards.
- 4.** Change the defective light bulb.
- 5.** Refit the light bulb cover and the cross head screw.

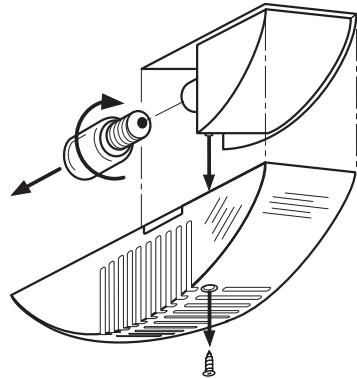

Hints and Tips

Normal Operating Sounds

- You may hear faint gurgling or bubbling sounds when the refrigerant is pumped through the coils or tubing at the rear, to the cooling plate/evaporator.
- When the compressor is on, the refrigerant is being pumped round and you will hear a whirring sound or pulsating noise from the compressor.
- A thermostat controls the compressor and you will hear a faint click when the thermostat cuts in and out.
- A murmuring noise can be made by the flows of air created by the fan.

Food Storage

To obtain the best performance from your refrigerator/freezer:

- Do not store warm food or evaporating liquids.
- Do not store food uncovered.
- Keep the time between buying chilled food and placing it in your freezer as short as possible.
- Do not push food together too much, try to allow air to circulate around each item.



Energy Saving Advice

- Do not install the appliance close to sources of heat, such as a cooker, dishwasher or radiator.
- Locate the appliance in a cool well ventilated room and make sure that the air openings of the appliance are not obstructed.
- Always leave warm food to cool down to room temperature before placing in the freezer compartment.
- Try to avoid keeping the door open for long periods or opening the door too frequently as warm air will enter the cabinet and cause the compressor to switch on unnecessarily often.
- Ensure there are no obstructions preventing the door from closing properly.

What to do if ...

Before contacting your local Service Force Centre, check the following points.

Symptom	Solution
No power to the appliance.	Check there is power at the socket
	Check there is not a power cut by checking the household lights.
	Check the fuse has not blown.
Appliance cools too much.	Temperature is set too cold. Temporarily select a higher temperature setting.
The temperature in the refrigerator/ freezer is too high.	Check the ambient temperature is within the appliances operating limits
	Check the temperature setting is correct relative to ambient conditions.
In the display, "POWER" is displayed.	There was a power failure. Please check whether the power plug is plugged in or whether the fuse has been tripped (see also section "Control and information system"). Check the status of the food.
Temperature display shows a square or a letter. In the display, "SERVICE" is displayed.	There is a function fault. Please contact your local Service Force Centre. Do not open the door of the appliance again.
Warning tone sounds, in the display "DOOR OPEN" and a red back light are flashing	"Open door" warning. Please check in "Control and Information System" section.
Warning tone sounds, a red back light is flashing. "TEMPERATURE" is flashing in the display	Temperature warning for freezer section or fridge section. Please check in "Control and Information System" section.
Interior illumination does not function. Important: The interior lighting switches off automatically after 7 minutes.	Please refer to "Replace Light Bulb " section.

Symptom	Solution
Excessive build up of frost.	If the door seal is not airtight (probably after reversing the door) apply warm air to the non sealing area using a hair dryer set to a gentle heat. (do not use a fan heater for this purpose). This will make the rubber more supple and allow it to revert to its original shape.
The compressor runs continuously	Adjust the temperature to give correct temperature control.
	Check that the doors are closed.
	Large quantities of food have recently been placed in the cabinet and/or door is frequently opened.
	Check that air ventilation is not obstructed.
Noise	Refer to Normal Operating Sounds
The compressor does not start immediately after changing the temperature setting.	This is normal, the compressor starts after a period of time.

If after the above checks there is still a fault, call your local AEG Service Force Centre.

In-guarantee customers should ensure that the above checks have been made as the engineer will make a charge if the fault is not a mechanical or electrical breakdown.

Please note that proof of purchase is required for in-guarantee service calls.

Regulations, Standards, Guidelines

This appliance was designed for household use and was manufactured in accordance with the appropriate standards. The necessary measures in accordance with appliance safety legislation regulations (GSG), accident prevention regulations for refrigeration appliances (VBG 20) and the regulations of the German Society of Electrical Engineers (VDE) were observed in the manufacture of this appliance.

The refrigerant circuit has been checked for leaks.

- CE** This appliance is in accordance with the following EU guidelines:
- 73/23/EEG dated 19 February 1973 - low voltage guidelines.
 - 89/336/EEG dated 3 May 1989
(including guideline change notice 92/31/EEG) - EMV guideline

Technical Terminology

- **Refrigerant**

Liquids that can be used to generate a cooling effect are known as refrigerants. They have a relatively low boiling-point, indeed so low, that the warmth from the food stored in the fridge or freezer can cause the refrigerant to boil and vaporise.

- **Refrigerant Circuit**

Closed circulation system that contains the refrigerant. The refrigerant circuit comprises primarily of an evaporator, a compressor, a condenser and pipe work.

- **Evaporator**

The refrigerant is evaporated in the evaporator. Similar to all other liquids, refrigerant requires heat to evaporate. This heat is removed from the interior of the appliance, as a result the interior is cooled. The evaporator is therefore located inside the appliance or placed in foam immediately behind the inner wall and thus not visible.

- **Compressor**

The compressor looks like a small drum. It is driven by a built-in electric motor and is mounted on the base of the appliance at the rear. The task of the compressor is to draw in vaporised refrigerant from the evaporator, to compress it, and to pass it on to the condenser.

- **Condenser**

The condenser normally has the form of a grid. The refrigerant compressed in the compressor is liquefied in the condenser. During this process, heat is released to the surrounding air at the surface of the condenser. The condenser is mounted on the base of the appliance.

Guarantee Conditions

Standard Guarantee Conditions

We, AEG, undertake that if within 12 months of the date of the purchase this AEG appliance or any part thereof is proved to be defective by reason only of faulty workmanship or materials, we will, at our discretion repair or replace the same FREE OF CHARGE for labour, materials or carriage on condition that:

- The appliance has been correctly installed and used only on the electricity or gas supply stated on the rating plate.
- The appliance has been used for normal domestic purposes only, and in accordance with the manufacturer's operating and maintenance instructions.
- The appliance has not been serviced, maintained, repaired, taken apart or tampered with by any person not authorised by us.
- All service work under this guarantee must be undertaken by a Service Force Centre. Any appliance or defective part replaced shall become the Company's property.
- This guarantee is in addition to your statutory and other legal rights.
- Home visits are made between 8.30am and 5.30pm Monday to Friday. Visits may be available outside these hours in which case a premium will be charged.

Exclusions

This guarantee does not cover:

- Damage or calls resulting from transportation, improper use or neglect, the replacement of any light bulbs or removable parts of glass or plastic.
- Costs incurred for calls to put right an appliance which is improperly installed or calls to appliances outside the United Kingdom.
- Appliances found to be in use within a commercial environment, plus those which are subject to rental agreements.
- Products of AEG manufacture which are not marketed by AEG.

European Guarantee

If you should move to another country within Europe then your guarantee moves with you to your new home subject to the following qualifications:

- The guarantee starts from the date you first purchased your product.
- The guarantee is for the same period and to the same extent for labour and parts as exists in the new country of use for this brand or range of products.
- This guarantee relates to you and cannot be transferred to another user.
- Your new home is within the European Community (EC) or European Free Trade Area.
- The product is installed and used in accordance with our instructions and is only used domestically, i.e. a normal household.
- The product is installed taking into account regulations in your new country.

Before you move please contact your nearest Customer Care centre, listed below, to give them details of your new home. They will then ensure that the local Service Organisation is aware of your move and able to look after you and your appliances..

France	Senlis	+33 (0) 3 44 62 29 29
Germany	Nürnberg	+49 (0) 800 234 7378
Italy	Pordenone	+39 (0) 800 117511
Sweden	Stockholm	+46 (0) 8 672 5360
UK	Slough	+44 (0) 1753 219899

Service & Spare Parts

In the event of your appliance requiring service, or if you wish to purchase spare parts, please contact Service Force by telephoning:

08705 929 929

Your telephone call will be automatically routed to the Service Force Centre covering your post code area.

For the address of your local Service Force Centre and further information about Service Force, please visit the website at www.serviceforce.co.uk

Before calling out an engineer, please ensure you have read the details under the heading „What to do if....“

When you contact the Service Force Centre you will need to give the following details:

1. Your name, address and post code.
2. Your telephone number
3. Clear and concise details of the fault.
4. The model and serial number of the appliance (found on the rating plate).

• Model Name



• Model Number (PNC)



• Serial Number (S-No.)



5. The purchase date

Please note that a valid purchase receipt or guarantee documentation is required for in-guarantee service calls.

Customer Care

For general enquiries concerning your AEG appliance or for further information on AEG products please contact our Customer Care Department by letter or telephone at the address below or visit our website at www.aeg.co.uk.

Customer Care Department
AEG Domestic Appliances
55-77 High Street
Slough
Berkshire, SL1 1DZ

Tel. 08705 350350 (*)

(*) Calls may be recorded for training purposes

 **From the Electrolux Group. The world's No. 1 choice.**

The Electrolux Group is the world's largest producer of powered appliances for kitchen, cleaning and outdoor use. More than 55 million Electrolux Group products (such as refrigerators, cookers, washing machines, vacuum cleaners, chain saws and lawn mowers) are sold each year to a value of approx. USD 14 billion in more than 150 countries around the world.

AEG Hausgeräte GmbH
Postfach 1036
D-90327 Nürnberg

<http://www.aeg.hausgeraete.de>

© Copyright by AEG

818 36 55 – 00/3 – 0105

Subject to change without notice