

KENWOOD

DUAL DIN SIZED CD RECEIVER

DPX701U
DPX501U

INSTRUCTION MANUAL

Kenwood Corporation



PHATNOISE

Contents

Safety precautions **4**

Notes **5**

About CDs **7**

About AAC, MP3 and WMA **8**

About USB device **10**

General features **11**

- Power
- Selecting the Source
- Volume
- Attenuator
- System Q
- Audio Control
- Adjusting the detail of Audio Control
- Audio Setup
- Speaker Setting
- Subwoofer Output
- TEL Mute
- Switching Display
- Display Type Selection
- Graphic part Display Switching
- Wallpaper selecting
- Text Selection for Display
- Text Display Switching
- Font Color Select

Tuner features **22**

- Tuning
- Direct Access Tuning
- Station Preset Memory
- Auto Memory Entry
- Preset Tuning

RDS features **24**

- Traffic Information
- Radio Text Scroll
- PTY (Program Type)
- Program Type preset
- Changing Language for PTY Function

CD/USB device/Audio file/External disc control features **27**

- Playing CD & Audio file
- Playing USB device
- Playing External Disc
- Fast Forwarding and Reversing
- Track/File Search
- Disc Search/Folder Search
- Direct Track/File Search
- Direct Disc Search
- Track/File/Disc/Folder Repeat
- Scan Play
- Random Play
- Magazine Random Play
- All Random Play
- Select mode
- File Select mode
- Folder Select 1 mode
- Folder Select 2 mode
- Switching the Play mode
- Letter Seek
- Text/Title Scroll

Menu system**34**

Menu System
Security Code
Touch Sensor Tone
Manual Clock Adjustment
Date Adjustment
Date Mode
Synchronize Clock
Indirect Lighting
Display Illumination Control
Dimmer
Switching preout
Built-in Amp Setting
Dual Zone System Setting
B.M.S. (Bass Management System)
B.M.S. Frequency Offset
AMP Control
News Bulletin with Timeout Setting
Local Seek
Tuning Mode
AF (Alternative Frequency)
Restricting RDS Region (Region Restrict
Function)
Auto TP Seek
Monaural Reception
External Display Control
Disc Naming (DNPS)
Auxiliary Input Display Setting
Selecting Russian Characters
Text Scroll
Built-in Auxiliary input Setting
Power OFF Timer
CD Read Setting
Voice Index
ACDrive firmware version display
Unique ID display
Audio Preset Memory
Audio Preset Recall
Demonstration mode Setting

Basic Operations of remote control 46

Accessories/ Installation Procedure 48

Connecting Wires to Terminals 49

Installing the Escutcheon 51

Installation 52

Removing the Unit 53

Troubleshooting Guide 54

Specifications 58

The "AAC" logo is trademark of Dolby Laboratories.

Safety precautions

▲WARNING

To prevent injury or fire, take the following precautions:

- To prevent a short circuit, never put or leave any metallic objects (such as coins or metal tools) inside the unit.
- Do not watch or fix your eyes on the unit's display when you are driving for any extended period.
- Mounting and wiring this product requires skills and experience. For safety's sake, leave the mounting and wiring work to professionals.

▲CAUTION

To prevent damage to the machine, take the following precautions:

- Make sure to ground the unit to a negative 12V DC power supply.
- Do not install the unit in a spot exposed to direct sunlight or excessive heat or humidity. Also avoid places with too much dust or the possibility of water splashing.
- When replacing a fuse, only use a new fuse with the prescribed rating. Using a fuse with the wrong rating may cause your unit to malfunction.
- Do not use your own screws. Use only the screws provided. If you use the wrong screws, you could damage the unit.

Do Not Load 3-in. CDs in the CD slot

If you try to load a 3 in. CD with its adapter into the unit, the adapter might separate from the CD and damage the unit.

About CD players/disc changers connected to this unit

Kenwood disc changers/ CD players released in 1998 or later can be connected to this unit.

Refer to the catalog or consult your Kenwood dealer for connectable models of disc changers/ CD players.

Note that any Kenwood disc changers/ CD players released in 1997 or earlier and disc changers made by other makers cannot be connected to this unit. Connecting unsupported disc changers/CD players to this unit may result in damage.

Set the "O-N" Switch to the "N" position for the applicable Kenwood disc changers/ CD players.

The functions you can use and the information that can be displayed may differ depending on the models being connected.



- You can damage both your unit and the CD changer if you connect them incorrectly.

Lens Fogging

When you turn on the car heater in cold weather, dew or condensation may form on the lens in the CD player of the unit. Called lens fogging, this condensation on the lens may not allow CDs to play. In such a situation, remove the disc and wait for the condensation to evaporate. If the unit still does not operate normally after a while, consult your Kenwood dealer.

Notes

About "Media Manager" of PC application attached to DPX701U/DPX501U

- "Media Manager" is recorded in the CD-ROM attached to this unit.
- Refer to the attached installation manual for the installation method of "Media Manager".
- Refer to the user's manual in the installation CD-ROM and Help of "Media Manager" for the operation method of "Media Manager".
- The unit can play CD/ USB device (hereafter called "ACDrive media") created by "Media Manager".
- Refer to the following site for updated information of "Media Manager".
<http://www.kenwood.mediamanager.jp>
- Contact Kenwood for the function and operation of the "Media Manager".
- "Media Manager" is a product of PhatNoise.

The marking of products using lasers (Except for some areas)

**CLASS 1
LASER PRODUCT**

The label is attached to the chassis/case and says that the component uses laser beams that have been classified as Class 1. This means that the unit is utilizing laser beams that are of a weaker class. There is no danger of hazardous radiation outside the unit.

This Product is not installed by the manufacturer of a vehicle on the production line, nor by the professional importer of a vehicle into an EU Member State.

Information on Disposal of Old Electrical and Electronic Equipment (applicable for EU countries that have adopted separate waste collection systems)



Products with the symbol (crossed-out wheeled bin) cannot be disposed as household waste.

Old electrical and electronic equipment should be recycled at a facility capable of handling these items and their waste byproducts. Contact your local authority for details in locating a recycle facility nearest to you. Proper recycling and waste disposal will help conserve resources whilst preventing detrimental effects on our health and the environment.

About CDs

Handling CDs

- Do not touch the recording surface of the CD.



- CD-R and CD-RW are easier to damage than a normal music CD. Use a CD-R or a CD-RW after reading the caution items on the package etc.
- Do not stick tape etc. on the CD, or use a CD with tape stuck on it.

When using a new CD

If the CD center hole or outside rim has burrs, use the CD only after removing the burrs with a ballpoint pen, etc.

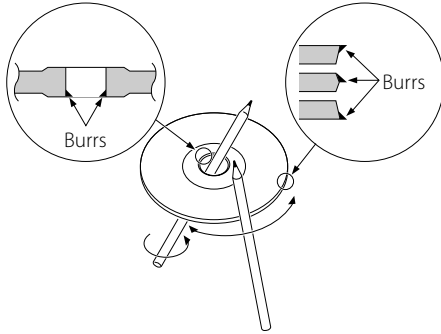

CD accessories

Do not use disc type accessories.

CD cleaning

Clean from the center of the disc and move outward.

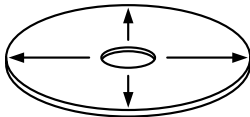

Removing CDs

When removing CDs from this unit, pull them out horizontally.

CDs that cannot be used

- CDs that are not round cannot be used.

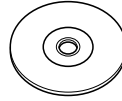

- CDs with coloring on the recording surface or CDs that are dirty cannot be used.
- This unit can only play the CDs with

About AAC, MP3 and WMA

The playable AAC/MP3/WMA file (hereafter called Audio file) and the media format has the following limitation. The Audio file, which is not conforming to the specification, may not play normally, or the file and folder names may not display correctly.

Playable Audio file

- AAC, MP3, WMA



- Attach the correct extension for the Audio file (AAC: ".M4A", MP3: ".MP3", WMA: ".WMA").
- Do not attach the extensions to files other than the Audio file. If the extension is attached, the file, which is not the Audio file, will play and outputs a loud noise, causing damage to the speaker.
- The files with copy protection cannot be played.
- Audio files cannot be played depending on the encoding software setting, USB device type, and/or recording conditions.
- The unit may not be compatible with upgrade of compression format standard and additional specifications.
- For details on the formats used for USB devices and restrictions, refer to <http://www.kenwood.mediamanager.jp/>.

Playable AAC file

- ".m4a" file encoded by AAC-LC format.
Refer to <http://www.kenwood.mediamanager.jp> for the details.

Playable MP3 file

- MPEG 1/2 Audio Layer 3 file
- Transfer bit rate: 8-320 kbps
- Sampling frequency: 16, 22.05, 24, 32, 44.1, 48 kHz

Playable WMA file

- The file in accordance with Windows Media Audio (Except for the file for Windows Media Player 9 or after which applies the new functions)
- Transfer bit rate: 48-192 kbps
- Sampling frequency: 32, 44.1, 48 kHz

Playable Storage media

- CD-ROM, CD-R, CD-RW
- USB device



- CD-RW discs which are quick formatted by the writing software cannot be used.
- When recording to the maximum CD-R/RW media capacity at once, the writing software is set to "Disc at once".
- For details on the available USB devices, refer to <About USB device> (page 10).

Playable CD-R/RW format

- ISO 9660 Level 1/2
- Joliet
- Romeo
- Long file name.

Playable file format of USB device

- For the formats supported by USB devices, refer to <http://www.kenwood.mediamanager.jp/>.

The maximum number of characters for display (CD-R/RW)

File/Folder name: 128 characters

MP3 ID3 Tag/ WMA Contents property:
30 characters

AAC song information: 60 characters



- File/Folder name is the number of the characters including the extensions.
- This unit can display the following versions of MP3 ID3 tag: version 1.0/ 1.1/ 2.2/ 2.3
- AAC ID3 Tag cannot be displayed.

Limitation of structure for the file and the folder (CD-R/RW)

- Maximum number of directory levels: 8
- Maximum number of folders: 100
- Maximum number of files per folder: 4096

About partition of the USB device

- While using the USB device, virtual folders are created to control the partition in the USB device. These folders appear in the first level (root) directory as "#:". "#" is an alphabet to identify each partition.
- Even when the USB device does not have partition, "A:" folder is created, and audio files are controlled inside this folder.

Playing order of the Audio file

- The Audio file plays in the order which is written by CD writing software. You may be able to set the playing order by writing the play sequence numbers such as "01" to "99" at the beginning of the file name.
- Audio files are played in the order the files are written. You can specify the order of playback by numbering files in a folder and writing them by folder. (USB device)

Example

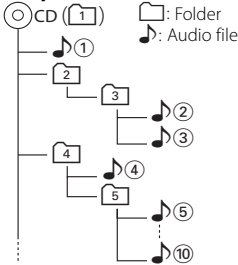

• Playing order

Playing order after 1 play.

➡ 2, 3, 4, 5...

• File search

Forward file search during 2 play.

Push the Control knob towards ➡ 3

• Folder search

Forward folder search during 2 play.

Push the Control knob towards [FM] ➡ 4, 5...

• File select

When the selection is set to file 5.

Push the Control knob towards

➡ 5... 10, 5...

• Folder select 1

When the selection is set to directory 4, and you want to skip to the folder 2 at the same level.

Push the Control knob towards ➡ 2

When the selection is set to directory 3, moves the level up by folder select.

Push the Control knob towards [AM] ➡ 2

• Folder select 2

When the selection is set to directory 1, and you want to skip to the folder 4.

Push the Control knob towards ➡ 3, 4...

About USB device

Notes on Use of the USB Device

This unit can play audio files stored in the flash memory and digital audio player that have a USB port (these devices are referred to as USB devices in this document).

The following restrictions are placed on the types and usage of available USB devices:

Available USB Devices

- USB devices belonging to the USB mass storage class.
- USB devices whose maximum current consumption is 500 mA or less.
For the supported formats and USB device types, refer to <http://www.kenwood.mediamanager.jp/>.



• USB Mass Storage Class:

- USB devices that the PC can recognize as an external storage without using any special driver or application software.
- Contact the sales agent as to whether your USB device conforms to the USB mass storage class specs.
- Using an unsupported USB device can result in abnormal playback or display of the audio file.
Even if you use the USB device conforming to the above specs, audio files cannot be played normally depending on the type or condition of the USB device.

About the Connection of the USB Device

- Do not directly connect the USB device to the USB connector on the panel. Connect it using a cable.
- When connecting the USB drive, usage of the supplied USB cable is recommended.
Normal playback is not guaranteed when a cable other than the USB compatible cable is used.
Connecting a cable whose total length is longer than 5 m can result in abnormal playback.



- You cannot connect a USB device via a USB hub.



- Install the USB device in the place where it will not prevent you from driving your vehicle properly.
- Do not leave the USB device in the vehicle for a long time. It can deform or damage due to direct sunlight, high temperature, etc.
- Take backups of the audio files used with this unit.
The files can be erased depending on the operating conditions of the USB device.
We shall have no compensation for any damage arising out of erasure of the stored data.
- Leave the cap on when not using an USB device.

About USB Device Operation

- USB device operation is the same as audio file operation unless otherwise some notice is indicated.
- USB source is recognized as CD source on the connected unit.

General features

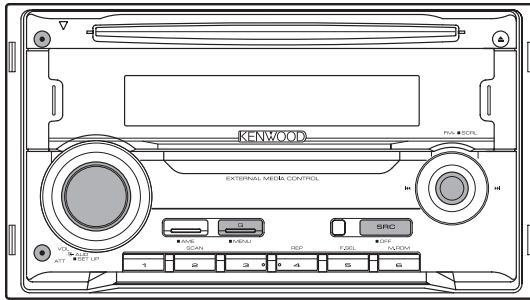

Power

Turning ON the Power
Press the [SRC] button.

When power is ON, the <Security Code> (page 42) is displayed as "CODE ON" or "CODE OFF".

Power

Press the [SRC] button for at least 1 second.

Display

"POWER"

"Compact Disc"/ "CD"

"Power"/

Auxiliary input (Optional accessory)

"AUX EXT"

Standby (Illumination only mode)

"STANDBY"



- This unit automatically turns full power OFF after 20 minutes lapses in Standby mode in order to save the vehicle's battery.

The time until full power OFF can be set in <Power OFF Timer> (page 42).

Volume

Increasing Volume

Turn the [VOL] knob clockwise.

Decreasing Volume

Turn the [VOL] knob counterclockwise.

General features

Attenuator

Turning the volume down quickly.

Press the [ATT] button.

Each time you press the button, the Attenuator turns ON and OFF.

When the Attenuator is ON, "ATT" is displayed.

System Q

Selecting the best sound setting preset for different types of music.

1 Select the source to set

Press the [SRC] button.

2 Select the Sound type

Press the [Q] button.

When you press the button once, the current sound setting is displayed.

Each time you press the button, the sound setting alternates.

Sound setting	Display
User memory	"USER"
Rock	"ROCK"
Pops	"POPS"
Easy	"EASY"
Top 40	"TOP 40"
Jazz	"JAZZ"
Natural	"NATURAL"



- User memory: The values set on the <Audio Control> (page 12).
- Change each setting value with the <Speaker Setting> (page 14).
First, select the speaker type with the Speaker setting.

Audio Control

1 Select the source to adjust

Press the [SRC] button.

2 Enter Audio Control mode

Press the [VOL] knob.

3 Select the Basic Audio item to adjust

Press the [VOL] knob.

Each time you press the knob, the item to be adjusted alternates between the items shown in the table below.

4 Adjust the Basic Audio item

Turn the [VOL] knob.

Adjustment Item	Display	Range
Rear Volume *1	"Rear Volume"/ "R-VOL"	0 — 35
Subwoofer level*2,3,4	"Sub-W Level"/ "SW L"	-15 — +15
Bass level*5	"Bass Level"/ "BAS L"	-8 — +8
Middle level*5	"Middle Level"/ "MID L"	-8 — +8
Treble level*5	"Treble Level"/ "TRE L"	-8 — +8
Balance	"Balance"/ "BAL" Left	15 — Right 15
Fader*4	"Fader"/ "FAD" Rear	15 — Front 15

Exit Audio Control mode (Volume control mode)



- *1 You can control this item when "2 ZONE"/ "2ZON" of <Audio Setup> (page 14) is set to "ON".
- *2 You can control this item when <Switching preout> (page 37) is set to "SWPRE SW". (DPX501U only)
- *3 You can control this item when <Subwoofer Output> (page 15) is set to "SW ON".
- *4 You can control this item when "2 ZONE"/ "2ZON" of <Audio Setup> (page 14) is set to "OFF".
- *5 You can adjust these items in detail. Refer to <Adjusting the detail of Audio Control>(Page13).
- *5 Source tone memory: Puts the set up value in the memory per source. (Detail Audio item is included)

5 Exit Audio Control mode

Press any button.

Press a button other than the [VOL] knob and [ATT] button.

Adjusting the detail of Audio Control

Among the Basic Audio items, you can adjust the Bass level, Middle level, and Treble level in detail.

1 Select the Basic Audio item

Select the desired item to be set in detail from followings;

- Bass level
- Middle level
- Treble level

For how to select Basic Audio items, see <Audio Control> (page 12).

2 Enter Detail adjustment mode of Audio Control

Press the [VOL] knob for at least 1 second.

3 Select the Detail Audio item to adjust Press the [VOL] knob.

Each time you press the knob, the item to be adjusted alternates between the items shown in the table below.

4 Adjust the Detail Audio item Turn the [VOL] knob.

Bass level

Adjustment Item	Display	Range
Bass Center Frequency	"Bass FRQ"/ "BAS F"	40/50/60/70/80/100/ 120/150 Hz
Bass Q Factor	"Bass QFactor"/ "BAS Q"	1.00/1.25/1.50/2.00
Bass Extend	"Bass EXT"/ "B EX"	OFF/ON

Middle level

Adjustment Item	Display	Range
Middle Center Frequency	"Middle FRQ"/ "MID F"	0.5/1.0/1.5/2.0 kHz
Middle Q Factor	"Middle QFactor"/ "MID Q"	1.00/2.00

Treble level

Adjustment Item	Display	Range
Treble Center Frequency	"Treble FRQ"/ "TRE"	10.0/12.5/15.0/17.5 kHz

5 Exit the Detail Audio Control mode

Press the [VOL] knob for at least 1 second.



- When you set the Bass Extend to ON, low frequency response is extended by 20%.
- You can exit the Audio Control mode at anytime by pressing any button except for [VOL] and [ATT] buttons.

General features

Audio Setup

Setting the Sound system, such as Cross over Network.

1 Select the source to adjust

Press the [SRC] button.

2 Enter Audio Setup mode

Press the [VOL] knob for at least 1 second.

3 Select the Audio Setup item to adjust

Press the [VOL] knob.

Each time you press the knob, the item to be adjusted alternates between the items shown in the table below.

4 Setup the Audio item

Turn the [VOL] knob.

Adjustment Item	Display	Range
Front High Pass Filter* ²	"HPF-F Fc"/ "HPF"	Through/40/60/80/100/120/ 150/180/220 Hz
Rear High Pass Filter* ²	"HPF-R Fc"/ "HPR"	Through/40/60/80/100/120/ 150/180/220 Hz
Low Pass Filter* ^{1,2}	"LPF-SW"/ "LPF"	50/60/80/100/120/ Through Hz
Subwoofer Phase* ^{1,2,3}	"SW Phase"/ "PHAS"	Reverse (180°)/ Normal (0°)
Volume offset	"Vol-Offset"/ "V-OFF"	-8 — ±0
Loudness	"LOUD"	OFF/ON
Dual Zone System	"2 ZONE"/ "ZZON"	OFF/ON



- Volume offset: Sets each source's volume as a difference from the basic volume.
- Loudness: Compensates for low and high tones during low volume.
- *¹ You can control this item when <Switching preout> (page 37) is set to "SWPRE SW". (DPX501U only)
- *¹ You can control this item when <Subwoofer Output> (page 15) is set to "SW ON".
- *² You can control this item when "2 ZONE"/"ZZON" of <Audio Setup> (page 14) is set to "OFF".
- *³ You can control this item when Low Pass Filter is not set to Through.
- Dual Zone System
Main source and sub source (Auxiliary input) output Front channel and Rear channel separately.
 - Set up the channel of sub source by <Dual Zone System Setting> (page 37).
 - Select Main source by [SRC] button.
 - Adjust the volume of Front channel by [VOL] knob.

- Adjust the volume of Rear channel by <Audio Control> (page 12).
- The Audio Control has no effect on sub source.
- You can use the Dual Zone System with the internal auxiliary input.

5 Exit Audio Setup mode

Press the [VOL] knob for at least 1 second.

Speaker Setting

Fine-tuning so that the System Q value is optimal when setting the speaker type.

1 Enter Standby

Press the [SRC] button.

Select the "STANDBY" display.

2 Enter Speaker Setting mode

Press the [VOL] knob.

"SP SEL"/ "SP" is displayed.

3 Select the Speaker type

Turn the [VOL] knob.

Each time you turn the knob, the setting alternates between the settings shown in the table below.

Speaker type	Display
OFF	"OFF"/ "SP OFF"
For 5 & 4 in. speaker	"5/4 inch"/ "SP 5/4"
For 6 & 6x9 in. speaker	"6x9/6 inch"/ "SP 6*9/6"
For the OEM speaker	"O.E.M."/ "SP OEM"

4 Exit Speaker Setting mode

Press the [VOL] knob.

Subwoofer Output

Turning the Subwoofer output ON or OFF.

Push the Control knob toward [AM] for at least 2 seconds.

Each time you push the knob, Subwoofer output switches ON and OFF.

When it is ON, "SW ON" is displayed.



- You can control this function when <Switching preout> (page 37) is set to "SWPRE SW". (DPX501U only)
- You can control this function when "2 ZONE" of <Audio Setup> (page 14) is set to "OFF".

TEL Mute

The audio system automatically mutes when a call comes in.

When a call comes in

"CALL" is displayed.

The audio system pauses.

Listening to the audio during a call

Press the [SRC] button.

The "CALL" display disappears and the audio system comes back ON.

When the call ends

Hang up the phone.

The "CALL" display disappears and the audio system comes back ON.



- To use the TEL Mute feature, you need to hook up the MUTE wire to your telephone using a commercial telephone accessory. Refer to <Connecting Wires to Terminals> (page 49).

General features

Function of the DPX501U

Switching Display

Changing the information displayed.

Press the [DISP] button.

Each time the button is pressed, the display switches as shown below.

In Tuner source

Information	Display
Program Service name or Frequency (FM)	"FREQ/PS"
Radio text, Program Service name or Frequency (FM)	"R-TEXT"
Frequency (MW, LW)	"FREQ"
Clock	"CLOCK"

In CD & External disc source

Information	Display
Disc title	"D-TITLE"*
Track title	"T-TITLE"*
Track number & Play time	"P-TIME"
Clock	"CLOCK"

In Audio file source

Information	Display
Song title & Artist name	"TITLE"*
Album name & Artist name	"ALBUM"*
Folder name	"FOLDER "
File name	"FILE "
Track number & Play time	"P-TIME"
Clock	"CLOCK"

In Standby/ Auxiliary input source

Information	Display
Source name	"SRC NAME"
Clock	"CLOCK"



- * If the contents of the information cannot be displayed, Play time or Frequency is displayed.
- Track number at Audio file displays the last 3 digits when it exceeds 1000 songs.
- When you select the clock display, the display setting of each source will be changed to the clock display.

Function of the DPX701U

Display Type Selection

Changing the display mode.

Press the [DISP] button.

Each time you press the button, the display mode alternates between the display modes shown in the table below.

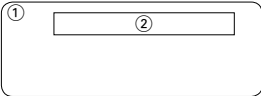
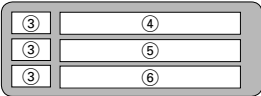
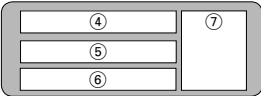
Display Mode	Display
Display type A	
Display type B	
Display type C	
Display type D	

- Graphic display part
- Text display part
- Text icon display part
- Upper text display part
- Middle text display part
- Lower text display part
- Source icon display part



- The indicator is displayed when the display type is set to Display Type C or Display Type D.
- To change the information by the Display Type, refer to the page on the following table for the methods to alternate by the Display Type.

Display Type	A	B	C	D
Graphic ①	17	17	—	—
Text ②	—	18	—	—
Upper ④	—	—	19	19
Middle ⑤	—	—	20	20
Lower ⑥	—	—	20	20

Switching between graphic display part and text display part when in Display Type B mode.

Press the [DISP] button.

Function of the DPX701U
Display Type A/ Display Type B

Graphic part Display Switching

Changing the graphic Display.

1 Select the display Type

Press the [DISP] button.

Select the Display Type A/ Display Type B.

2 Enter graphic display select mode

Press the [DISP] button for at least 1 second.

Display Type A : Press the [DISP] button for at least 1 second.

Display Type B : After pressing the [DISP] button for more than 1 second to text selection mode. Press the [DISP] button again.

3 Select the graphic part display

Push the Control knob towards [◀◀] or [▶▶].

Each time you push the knob, the graphic display alternates between the displays shown in the table below.

Graphic display
Movie 1
Movie 2
Wallpaper

4 Exit graphic display select mode

Press the [DISP] button.



- The setting of this function is available while Display Type A/ Display Type B is selected for the Display mode.

Function of the DPX701U
Display Type A/ Display Type B

Wallpaper selecting

Selecting a wallpaper to display when Display Type is set to Display Type A/ Display Type B.

1 Select the wallpaper display

Refer to <Graphic part Display Switching> (page 17).

2 Select the wallpaper

Display the wallpapers one after another

Press the Control knob.

Each time you press the button, the Wallpaper scan is turned ON and OFF.

When scan is ON, "SCAN" is displayed.

When scan is ON, each wallpaper is displayed every several seconds.

Select wallpaper manually

1 Turn the wallpaper scan OFF.

Press the Control knob.

Each time you press the button, the Wallpaper scan is turned ON and OFF.

2 Select the wallpaper.

Push the Control knob towards [FM] or [AM].

Each time you push the knob, the Wallpaper changes.

3 Exit Display Control mode

Press the [DISP] button.

General features

Function of the DPX701U
Display Type B

Text Selection for Display

Selecting the text display.

1 Select the display Type

Press the [DISP] button.

Select the Display Type B.

2 Enter text select mode

Press the [DISP] button for at least 1 second.

3 Select the text

Push the Control knob towards [◀◀] or [▶▶].

In Tuner source

Information	Display
Program Service name (FM)	"Frequency/PS"*
Radio text or Program Service name (FM)	"Radio Text"*
Frequency (MW, LW)	"Frequency"
Clock	"Clock"
Date	"Date"

In CD & External disc source

Information	Display
Disc title	"Disc Title"*
Track title	"Track Title"*
Track number & Play time	"P-Time"
Disc name	"DNPS"
Clock	"Clock"
Date	"Date"

In Audio file source

Information	Display
Song title & Artist name	"Title/Artist"*
Album name & Artist name	"Album/Artist"*
Folder name	"Folder Name"
File name	"File Name"
Play time & File number	"P-Time"
Clock	"Clock"
Date	"Date"

In Standby/ Auxiliary input source

Information	Display
Source name	"Source Name"
Clock	"Clock"
Date	"Date"

4 Exit text select mode

Press the [DISP] button for at least 1 second.



- * If the contents of the information cannot be displayed, Play time or Frequency is displayed.
- When LX-AMP is connected, the item setup by the Display mode of LX-AMP is displayed.
- Track number at Audio file displays the last 3 digits when the track number exceeds 1000 songs.

Function of the DPX701U
Display Type C/ Display Type D

Text Display Switching

Changing the text display.

1 Select the display Type

Press the [DISP] button.

Select the Display Type C/Display Type D.

2 Enter text select mode

Press the [DISP] button for at least 1 second.

3 Select the text display part

Push the Control knob towards [FM] or [AM].

The cursor (➡) moves to the selected text display part.

Select the text

Push the Control knob towards [◀◀] or [▶▶].

Refer to the table described later for setting items.

4 Exit text select mode

Press the [DISP] button.



- Same information cannot be displayed in Upper text display part, Middle text display part and Lower text display part. However, the blank display is able to have multiple selections.
- Track number at Audio file displays the last 3 digits when the track number exceeds 1000 songs.
- When LX-AMP is connected, the item setup by the Display mode of LX-AMP is displayed.

The text display in the Upper text display part

In Tuner source

Information	Display
Program Service name (FM)	"Frequency/PS"*
Radio text or Program Service name (FM)	"Radio Text"*
Frequency (MW, LW)	"Frequency"
Clock	"Clock"
Date	"Date"

In CD & External disc source

Information	Display
Disc title	"Disc Title"*
Track title	"Track Title"*
Track number & Play time	"P-Time"
Disc name	"DNPS"
Clock	"Clock"
Date	"Date"

In Audio file source

Information	Display
Song title & Artist name	"Title/Artist"*
Album name & Artist name	"Album/Artist"*
Folder name	"Folder Name"
File name	"File Name"
Play time & File number	"P-Time"
Clock	"Clock"
Date	"Date"

In Standby/ Auxiliary input source

Information	Display
Source name	"Source Name"
Clock	"Clock"
Date	"Date"



- * If the contents of the information cannot be displayed, Play time or Frequency is displayed.

General features

The text display in the Middle text display part

In Tuner source

Information	Display
Clock	"Clock"
Date	"Date"
Blank	"Blank"
Radio text (FM)	"Radio Text"*

In CD & External disc source

Information	Display
Clock	"Clock"
Date	"Date"
Blank	"Blank"
Disc title	"Disc Title"*
Track title	"Track Title"*
Disc name	"DNPS"

In Audio file source

Information	Display
Clock	"Clock"
Date	"Date"
Blank	"Blank"
Song title & Artist name	"Title/Artist"*
Album name & Artist name	"Album/Artist"*
Folder name	"Folder Name"
File name	"File Name"

In Standby/ Auxiliary input source

Information	Display
Clock	"Clock"
Date	"Date"
Blank	"Blank"



- * If the contents of the information cannot be displayed, Kenwood Logo is displayed.

The text display in the Lower text display part

In Tuner source

Information	Display
Indicator	"Status"
Clock	"Clock"
Date	"Date"
Blank	"Blank"
Radio text (FM)	"Radio Text"*

In CD & External disc source

Information	Display
Indicator	"Status"
Clock	"Clock"
Date	"Date"
Blank	"Blank"
Disc title	"Disc Title"*
Track title	"Track Title"*
Disc name	"DNPS"

In Audio file source

Information	Display
Indicator	"Status"
Clock	"Clock"
Date	"Date"
Blank	"Blank"
Song title & Artist name	"Title/Artist"*
Album name & Artist name	"Album/Artist"*
Folder name	"Folder Name"
File name	"File Name"

In Standby/ Auxiliary input source

Information	Display
Indicator	"Status"
Clock	"Clock"
Date	"Date"
Blank	"Blank"



- * If the contents of the information cannot be displayed, indicator is displayed.

Font Color Select

Selecting the display font color.

1 Enter text select mode

Display type B : Refer to <Text Selection for Display> (page 18).

Display type C/D : Refer to <Text Display Switching> (page 18).

2 Switch from text selection to Font Color selection

Press the Control knob.

3 Select the text display part

Select the row (Display Type C/ Display Type D only)

Push the Control knob towards [FM] or [AM].

The cursor (➡) moves to the selected text display part.

Select the Font Color

Push the Control knob towards [◀◀] or [▶▶].

4 Exit Font Color select mode

Press the Control knob.



- When you selected the Display Type B display, select an easy viewable font color.
- The "Status" item of Display type C/D can be set; however, the actual display color does not change.

Tuner features

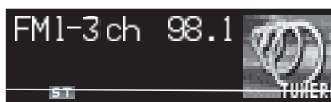
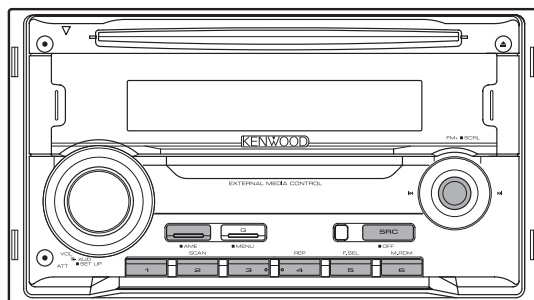

Tuning

Selecting the station.

1 Select tuner source

Press the [SRC] button.

Select the "TUNER" display.

2 Select the band

Push the Control knob towards [FM] or [AM].

Each time you push the knob toward [FM], it switches between the FM1, FM2, and FM3 bands.

3 Tune up or down band

Push the Control knob towards [◀◀] or [▶▶].



- During reception of stereo stations the "ST" indicator is ON.

Accessory of the DPX701U

Function of remote control

Direct Access Tuning

Entering the frequency and tuning.

1 Select the band

Press the [FM] or [AM] button.

2 Enter Direct Access Tuning mode

Press the [DIRECT] button on the remote control.

"----" is displayed.

3 Enter the frequency

Press the number buttons on the remote control.

Example:

Desired frequency	Press button
92.1 MHz (FM)	[0], [9], [2], [1]
810 kHz (AM)	[0], [8], [1], [0]

Cancelling Direct Access Tuning

Press the [DIRECT] button on the remote control.

Station Preset Memory

Putting a station in the memory.

1 Select the band

Push the Control knob towards [FM] or [AM].

2 Select the frequency to put in the memory

Push the Control knob towards [◀◀] or [▶▶].

3 Put the frequency in the memory

Press the desired [1] — [6] button for at least 2 seconds.

The preset number display blinks 1 time.
On each band, 1 station can be put in the memory on each [1] — [6] button.

Auto Memory Entry

Putting stations with good reception in the memory automatically.

1 Select the band for Auto Memory Entry

Push the Control knob towards [FM] or [AM].

2 Open Auto Memory Entry

Press the [AME] button for at least 2 seconds.

When 6 stations that can be received are put in the memory, Auto Memory Entry closes.



- When the <AF (Alternative Frequency)> (page 39) is ON, only RDS stations are put in the memory.
- When Auto Memory Entry is done in the FM2 band, the RDS stations preset in the FM1 band are not put in the memory.

Likewise, when Auto Memory Entry is done in the FM3 band, RDS stations preset in FM1 or FM2 are not put in the memory.

Preset Tuning

Recalling the stations in the memory.

1 Select the band

Push the Control knob towards [FM] or [AM].

2 Recall the station

Press the desired [1] — [6] button.

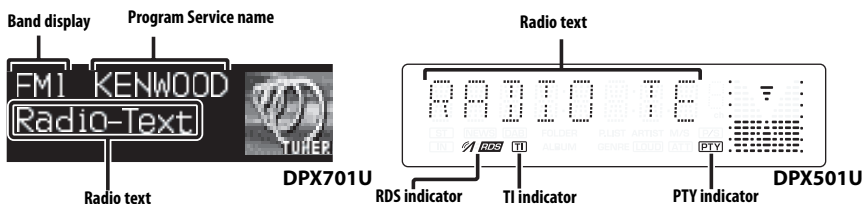
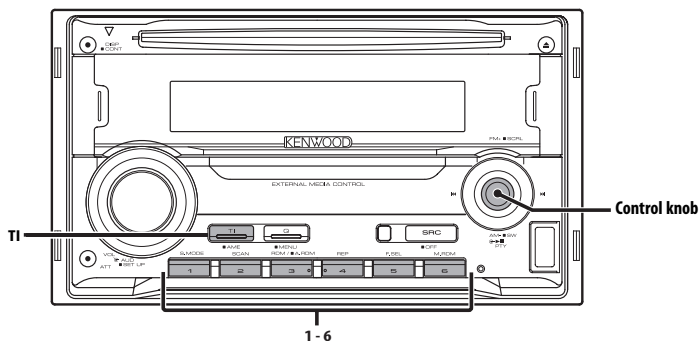

Traffic Information

Changing to traffic information automatically when a traffic bulletin starts even when you are not listening to the radio.

Press the [TI] button.

Each time you press the button, the Traffic Information function turns ON and OFF. When traffic information is ON, "TI" indicator is ON. (DPX501U only)

When a traffic information station is not being received the "TI" indicator blinks.

When a traffic bulletin starts, "Traffic INFO"/ "TRAFFIC" is displayed and the audio changes to traffic information.



- During reception of an AM station when the Traffic Information function is turned ON, the frequency changes to an FM station.
- During reception of traffic information the adjusted volume is automatically remembered, and the next time the audio changes to traffic information, the volume automatically becomes the remembered volume.

Receiving other traffic information stations

Push the Control knob towards [◀◀] or [▶▶].



- Traffic information can be switched when it is on the Tuner Source. However, you cannot switch the Traffic information during reception of the Traffic bulletin switched from the source other than the Tuner.

Radio Text Scroll

Scrolling the displayed radio text.

Push the Control knob toward [FM] for at least 2 seconds.



- When the <Display Illumination Control> (page 37) is set to OFF, the display may black out while scrolling.

PTY (Program Type)

Selecting the Program Type and searching for a station.

1 Enter PTY mode

Press the Control knob.

"PTY Select" is displayed. (DPX701U only)
During PTY mode the "PTY" indicator is ON.
(DPX501U only)



- This function cannot be used during a traffic bulletin or AM reception.

2 Select the Program Type

Push the Control knob towards [FM] or [AM].

Each time you push the knob, the Program Type alternates between the program types shown in the table below.

No.	Program Type	Display DPX701U	DPX501U
1.	Speech	"All Speech"	"SPEECH"
2.	Music	"All Music"	"MUSIC"
3.	News	"News"	"NEWS"
4.	Current Affairs	"Current Affairs"	"AFFAIRS"
5.	Information	"Information"	"INFO"
6.	Sport	"Sport"	"SPORT"
7.	Education	"Education"	"EDUCATE"
8.	Drama	"Drama"	"DRAMA"
9.	Culture	"Cultures"	"CULTURE"
10.	Science	"Science"	"SCIENCE"
11.	Varied	"Varied Speech"	"VARIED"
12.	Pop Music	"Pop Music"	"POP M"
13.	Rock Music	"Rock Music"	"ROCK M"
14.	Easy Listening Music	"Easy Listening M"	"EASY M"
15.	Light Classical	"Light Classic M"	"LIGHT M"
16.	Serious Classical	"Serious Classics"	"CLASSICS"
17.	Other Music	"Other Music"	"OTHER M"
18.	Weather	"Weather & Metr"	"WEATHER"
19.	Finance	"Finance"	"FINANCE"
20.	Children's programs	"Children's Prog"	"CHILDREN"
21.	Social Affairs	"Social Affairs"	"SOCIAL"
22.	Religion	"Religion"	"RELIGION"
23.	Phone In	"Phone In"	"PHONE IN"
24.	Travel	"Travel & Touring"	"TRAVEL"
25.	Leisure	"Leisure & Hobby"	"LEISURE"
26.	Jazz Music	"Jazz Music"	"JAZZ"
27.	Country Music	"Country Music"	"COUNTRY"
28.	National Music	"National Music"	"NATION M"
29.	Oldies Music	"Oldies Music"	"OLDIES"

30.	Folk Music	"Folk Music"	"FOLK M"
31.	Documentary	"Documentary"	"DOCUMENT"



- Speech and Music include the Program type shown below.
Music: No.12 — 17, 26 — 30
Speech: No.3 — 11, 18 — 25, 31
- You can put the Program Type in the [1] — [6] button memory and for quick recall. Refer to the <Program Type preset> (page 25).
- You can change the display language. Refer to <Changing Language for PTY Function> (page 26).

3 Search for the selected Program Type station

Push the Control knob towards [◀◀] or [▶▶].

When you want to search for other stations, push [◀◀] or [▶▶] of the Control knob again.



- When the selected Program Type is not found, "NO PTY" is displayed. Select another Program Type.

4 Exit PTY mode

Press the Control knob.

Program Type preset

Putting the Program Type in the Preset button memory and quick recall.

Presetting the Program Type

1 Select the Program Type to preset

Refer to <PTY (Program Type)> (page 25).

2 Preset the Program Type

Press the desired [1] — [6] button for at least 2 seconds.

Recalling the preset Program Type

1 Enter PTY mode

Refer to <PTY (Program Type)> (page 25).

2 Recall the Program Type

Press the desired [1] — [6] button.

Changing Language for PTY Function

Selecting the Program Type display language.

1 Enter PTY mode

Refer to <PTY (Program Type)> (page 25).

2 Enter Changing Language mode

Press the [TI] button.

3 Select the language

Push the Control knob towards [FM] or [AM].

Each time you push the knob, the language alternates between the languages shown in the table below.

DPX701U

Language	Display
English	"English"
Spanish	"Spanish"
French	"French"
Dutch	"Dutch"
Norwegian	"Norwegian"
Portuguese	"Portuguese"
Swedish	"Swedish"
German	"German"

DPX501U

Language	Display
English	"ENGLISH"
French	"FRENCH"
Swedish	"SWEDISH"
German	"GERMAN"

4 Exit Changing Language mode

Press the [TI] button.

CD/USB device/Audio file/External disc control features

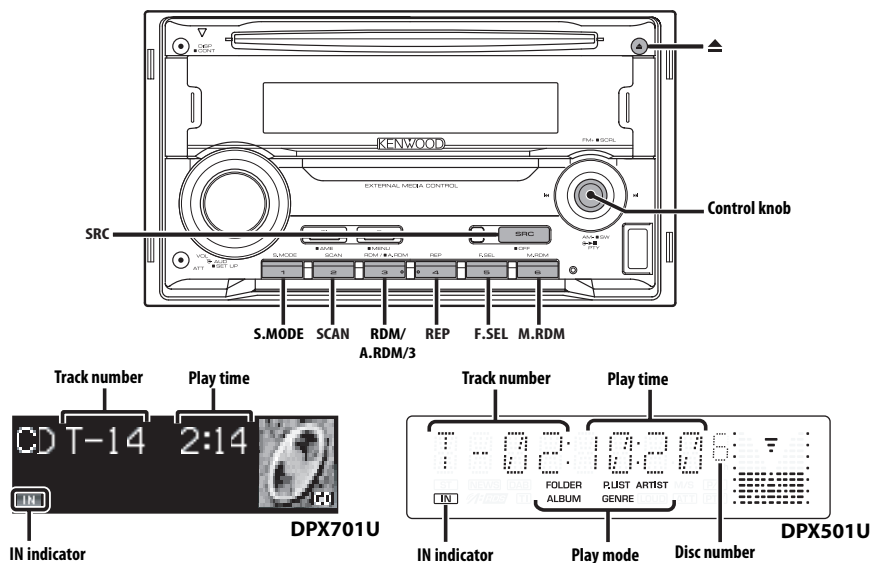

Playing CD & Audio file

When a disc is inserted

Press the [SRC] button.

Select the "Compact Disc"/ "CD" display.



- When a CD is inserted, the "IN" indicator is ON.

Pause and play

Press the Control knob.

Each time you press the knob, the audio pauses or plays.

Eject the CD

Press the [▲] button.



- You can cancel the announcement when selecting the folder by <Voice Index> (page 43) during the play of the ACDrive media.

Playing USB device

Playing USB device

1 Select a source other than the USB device

Press the [SRC] button.

2 Connect the USB device.

3 Select USB source

Press the [SRC] button.

Select the "USB" display.



- Refer to <About AAC, MP3 and WMA> (page 8) for the Audio file you can play.
- For the types of available USB devices and how to connect USB devices, refer to <About USB device> (page 10).
- After you stopped playing a file contained in the USB device, you can restart playing the file from the point where you stopped its playback.
Even after removing the USB device, you can restart playing the file from the point where you stopped its playback as long as the files contained in the USB device are all the same.
- Be sure to insert the USB device connector as far as it will go.
- You can play the disc (ACDrive media) made by Media Manager by the same operation.
- You can cancel the announcement when selecting the folder by <Voice Index> (page 43) during the the ACDrive media.

Pause and play

Press the Control knob.

Each time you press the knob, the audio pauses or plays.

Removing the USB Device

1 Select a source other than the USB device

Press the [SRC] button.

2 Remove the USB device.



- Removing the USB device with it selected as a source can damage the data stored in the USB device.



- You can remove the USB device safely with the unit power turned off.

Playing External Disc

Playing discs set in the optional accessory disc player connected to this unit.

Press the [SRC] button.

Select the display for the disc player you want.

Display examples:

Display	Disc player
"CD Changer"/ "CD CH"	CD changer
"MD Changer"/ "MD CH"	MD changer

Pause and play

Press the Control knob.

Each time you press the knob, the audio pauses or plays.



- Disc 10 is displayed as "0". (DPX501U only)
- The functions that can be used and the information that can be displayed will differ depending on the external disc players being connected.

Fast Forwarding and Reversing

Fast Forwarding

Hold down toward [▶▶] with the Control knob.

Release to resume the playback.

Reversing

Hold down toward [◀◀] with the Control knob.

Release to resume the playback.



- There is no sound while the Audio file is being searched.
- You cannot fast Forwarding and Reversing depending on AAC file format.

Playing USB device

Playing USB device

1 Select a source other than the USB device.

2 Select USB source

Press the [SRC] button.

Select the "USB" display.



- Refer to <About AAC, MP3 and WMA> (page 8) for the Audio file you can play.
- For the types of available USB devices and how to connect USB devices, refer to <About USB device> (page 10).
- After you stopped playing a file contained in the USB device, you can restart playing the file from the point where you stopped its playback.
Even after removing the USB device, you can restart playing the file from the point where you stopped its playback as long as the files contained in the USB device are all the same.
- Be sure to insert the USB device connector as far as it will go.
- You can play the disc (ACDrive media) made by Media Manager by the same operation.
- You can cancel the announcement when selecting the folder by <Voice Index> (page 43) during the the ACDrive media.

Pause and play

Press the Control knob.

Each time you press the knob, the audio pauses or plays.

Removing the USB Device

1 Select a source other than the USB device

Press the [SRC] button.

2 Remove the USB device.



- Removing the USB device with it selected as a source can damage the data stored in the USB device.



- You can remove the USB device safely with the unit power turned off.

Playing External Disc

Playing discs set in the optional accessory disc player connected to this unit.

Press the [SRC] button.

Select the display for the disc player you want.

Display examples:

Display	Disc player
"CD Changer"/ "CD CH"	CD changer
"MD Changer"/ "MD CH"	MD changer

Pause and play

⚠ 139.5 w051 143.3 c18 selected as a source can damage the data stored in the USB device.

Track/File Search

Searching for a song on the disc or in the Audio file folder.

Push the Control knob towards [**◀◀**] or [**▶▶**].

Function of disc changer/ Audio file

Disc Search/Folder Search

Selecting the disc set in the Disc changer or the folder recorded on the Audio file media.

Push the Control knob towards [**FM**] or [**AM**].

*Accessory of the DPX701U
Function of remote control*

Direct Track/File Search

Doing Track/File Search by entering the track/file number.

1 Enter the track/file number

Press the number buttons on the remote control.



- You can select Direct File Search up to 999.

2 Do Track/File Search

Press the [**◀◀**] or [**▶▶**] button.

Cancelling Direct Track/File Search

Press the [**▶||**] button.

Accessory of the DPX701U

Function of disc changers with remote control

Direct Disc Search

Doing Disc Search by entering the disc number.

1 Enter the disc number

Press the number buttons on the remote control.

2 Do Disc Search

Press the [**+**] or [**-**] button.

Cancelling Direct Disc Search

Press the [**▶||**] button.



- Input "0" to select disc 10.

Track/File/Disc/Folder Repeat

Replaying the song, disc in the Disc changer or Audio file folder you are listening to.

Press the [**REP**] button.

Each time you press the button, the Repeat Play alternates between the modes shown in the tables below.

In CD & External disc source

Repeat play	Display
Track Repeat	"Track Repeat ON" / "TRAC REP"
Disc Repeat (In Disc Changer)	"Disc Repeat ON" / "DISC REP"
OFF	"Repeat OFF" / "REP OFF"

In Audio file source

Repeat play	Display
File Repeat	"File Repeat ON" / "FILE REP"
Folder Repeat	"Folder Repeat ON" / "FOLD REP"
OFF	"Repeat OFF" / "REP OFF"

CD/USB device/Audio file/External disc control features

Scan Play

Playing the first part of each song on the disc or Audio file folder you are listening to and searching for the song you want to hear.

1 Start Scan Play

Press the [SCAN] button.

"Scan ON"/ "Track Scan ON"/ "File Scan ON"/ "SCAN ON"/ "TRAC SCN"/ "FILE SCN" is displayed.

2 Release it when the song you want to listen to is played

Press the [SCAN] button.

Random Play

Playing all the songs on the disc in random order.

Press the [RDM] button.

Each time you press the button, Random Play turns ON or OFF.

When the Random mode is ON, "Random ON"/ "Disc Random ON"/ "Folder RDM ON"/ "DISC RDM"/ "FOLD RDM" is displayed.



- When you push the Control knob toward [▶▶], the next random song starts.

Function of disc changer

Magazine Random Play

Play the songs on all the discs in the disc changer in random order.

Press the [M.RDM] button.

Each time you press the button, the Magazine Random Play turns ON or OFF.

When the Magazine Random mode is ON, "Magazine RDM ON"/ "MGZN RDM" is displayed.



- When you push the Control knob toward [▶▶], the next random song starts.

Function of Audio file

All Random Play

Playing randomly from all of the Audio files recorded in the media.

Press the [A.RDM] button for at least 1 second.

When the random mode is ON, "All Random ON"/ "ALL RDM" is displayed.

Canceling the All Random Play

Press the [A.RDM] button.



- When you push the Control knob toward [▶▶], the next random song starts.

Function of Audio file

Select mode

Quickly selecting the file or folder you want to hear.

1 Select the Select mode

Press the [FSEL] button.

Display	Select mode
"FILE SELECT"/ "FILE SEL"*1	Refer to <File Select mode> (page 31).
"FOLDER SELECT1"/ "FOLDER SELECT"/ "FLD SEL1"/ "FLD SEL"	Refer to <Folder Select 1 mode> (page 32).
"FOLDER SELECT2"/ "FLD SEL2"*2	Refer to <Folder Select 2 mode> (page 32).

Exit the Select mode



- The Select mode does not function when <All Random Play> (page 30) is ON.
- *1 You cannot operate this function when <Random Play> (page 30) is set to "ON".
- *2 You cannot operate this function when <Switching the Play mode> (page 33) is set to other than "Folder Mode"/ "FOLDER" while playing ACDrive media.

2 Select the file/ folder

Refer to the explanation of the procedure performed in each select mode.

Scrolling the file/ folder name display

Push the Control knob toward [FM] for at least 2 seconds.



- You can cancel the announcement when selecting the folder by <Voice Index> (page 43) during the play of the ACDrive media.
- In the File Select mode, the <Voice Index> (page 43) announcement is not made.

Function of Audio file

File Select mode

You can select an audio file in the folder currently being played by file name.

1 Enter File Select mode

Press the [F.SEL] button.

Select the "FILE SELECT"/ "FILE SEL" display.

Refer to <Select mode> (page 30).

File name display

Displays the current file name.



File number display

Displays the number in the folder belonging to the currently selected file.

Displays the current file name.



CD/USB device/Audio file/External disc control features

Function of Audio file

Folder Select 1 mode

Select the target folder by tracing the hierarchical levels of folders. This is convenient when managing audio files by folder.

1 Enter Folder Select 1 mode

Press the [F.SEL] button.

Select the "FOLDER SELECT1"/ "FLD SEL1"/ "FOLDER SELECT"/ "FLD SEL" display.

Refer to <Select mode> (page 30).

Folder name display

Displays the current folder name.



Folder number display

Displays the number in the folder belonging to the currently selected folder.

Displays the current folder name.

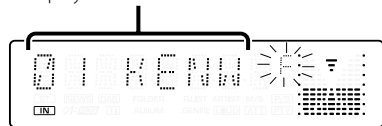

2 Select the folder level*

Push the Control knob towards [FM] or [AM].

With the [FM] button, you move 1 level down and with the [AM] button, 1 level up.

Selecting a folder in the same level

Push the Control knob towards [◀◀] or [▶▶].

With the [◀◀] of the Control knob, you move to the previous folder, and with the [▶▶] of the Control knob, to the next folder.

Returning to the top level*

Press the [3] button.



- * You cannot operate this function when <Switching the Play mode> (page 33) is set to other than "Folder Mode" while playing ACDrive media.

3 Decide the folder to play

Press the Control knob.

The Folder Select mode releases, and the Audio file in the folder being displayed plays.

Function of Audio file

Folder Select 2 mode

Select the target folder within the folders containing audio files. The folder which contains playable audio files is only displayed.

1 Enter Folder Select 2 mode

Press the [F.SEL] button.

Select the "FOLDER SELECT2"/ "FLD SEL2" display.

Refer to <Select mode> (page 30).

Folder name display

Displays the current folder name.



Folder number display

Displays the number in the folder belonging to the currently selected folder.

Displays the current folder name.

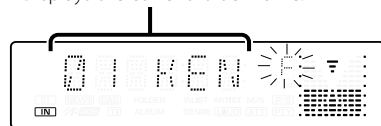

2 Select the folder

Push the Control knob towards [◀◀] or [▶▶].

Each time you push the knob, the folders containing audio files are displayed one after another.

Check the name of upper level folder

Push the Control knob towards [FM] or [AM].

With the [FM] button, the folder name in the upper level is displayed.

With the [AM] button, the folder name in the lower level is displayed.

"□"/"⏏" is displayed while the upper level folder is displayed.

3 Decide the folder to play

Press the Control knob.

The Folder Select mode releases, and the Audio file in the folder being displayed plays.

Function of ACDrive media

Switching the Play mode

Arrange the playing orders of the songs by categories.

Press the [S.MODE] button.

Each time you press the button, the Play mode alternates between the modes shown in the table below.

The Play mode indicator is ON. (DPX501U only)

Play mode	Category which is to be arranged
"PlayList Mode"/ "PLAYLIST"	Play list order.
"Genre Mode"/ "GENRE"	By genre.
"Artist Mode"/ "ARTIST"	By artist.
"Album Mode"/ "ALBUM"	By album.
"Folder Mode"/ "FOLDER"	By the folder recorded in media



- The category information of each song is the data registered in Media Manager when ACDrive media is being generated.
- You can cancel the announcement made when the mode is changed by <Voice Index> (page 43).
- You can select the advancement of the Play mode information by [AM] and [FM] knob.

Function of ACDrive media

Letter Seek

You can search for the song, you want to play, by selecting the initial of Genre name, Artist name, or Album name.

1 Enter the Letter Seek mode

Press the [S.MODE] button for at least 1 second.



- This operation does not function when <All Random Play> (page 30) is ON.
- This function is available only when the Play mode is set Genre, Artist, or Album.

2 Start the Letter Seek

Press the [S.MODE] button.

2 Start the Letter Seek

Push the Control knob towards [◀◀] or [▶▶].

The initial of Genre name, Artist name, or Album name is displayed and announced in order.



- The announcement of the initial can be canceled by <Voice Index> (page 43).
- When you push the Control knob to the reverse [◀◀] or [▶▶] during Letter Seek, the initial is displayed and announced in the reversed order.
- Once Letter Seek starts, it cannot be cancelled.

3 Select the song to play

Press the Control knob when the initial of the song you are searching is displayed and announced.

The selected initial group plays.



- Letter seek can be performed for letters of the alphabet (A-Z).

Text/Title Scroll

Scrolling the displayed CD text, Audio file text, or MD title.

Push the Control knob toward [FM] for at least 2 seconds.



- When the <Display Illumination Control> (page 37) is set to OFF, the display may black out while scrolling.

Menu system

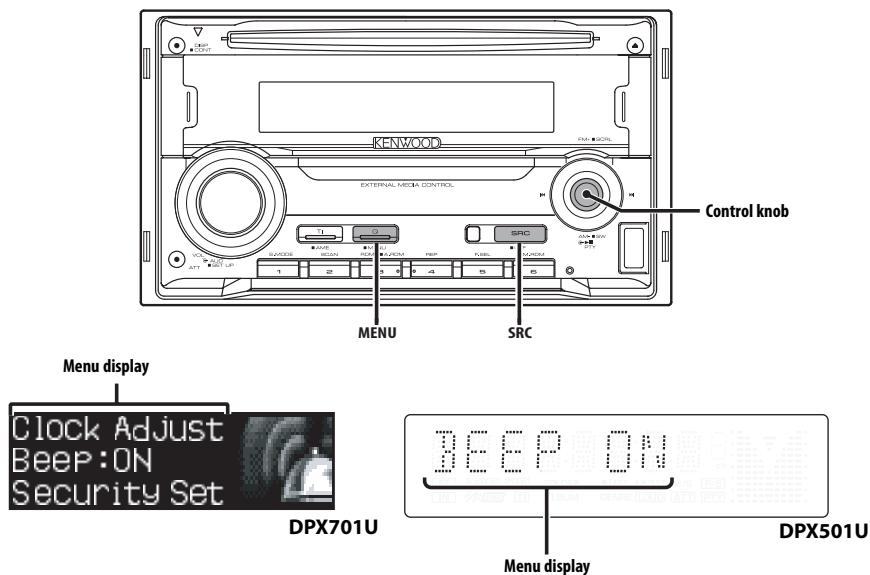

Menu System

Setting beep sound during operation, etc. functions.

The Menu system basic operation method is explained here. The reference for the Menu items and their setting content is after this operation explanation.

1 Enter Menu mode

Press the [MENU] button for at least 1 second.

"MENU" is displayed.

2 Select the menu item

Push the Control knob towards [FM] or [AM].

Example: When you want to set the beep sound select the "Beep"/ "BEEP" display.

3 Set the menu item

Push the Control knob towards [◀◀] or [▶▶].

Example: When you select "Beep"/ "BEEP", each time you push the knob it alternates between "Beep : ON"/ "BEEP ON" or "Beep : OFF"/ "BEEP OFF". Select 1 of them as the setting.

You can continue by returning to step 2 and setting other items.

4 Exit Menu mode

Press the [MENU] button.



- When other items those applicable to the basic operation method above are displayed, their setting content chart is entered. (Normally the setting listed at the top of the chart is the original setting.) Also, the explanation for items that are not applicable (<Manual Clock Adjustment> etc.) are entered step by step.
- Three menu items appear on the display. The menu item displayed at the center is the one you can adjust. (DPX701U only)

In Standby mode

Security Code

Activating the Security Code disables the usage of audio unit by someone else. Once the Security Code is activated, the entry of authorized Security Code is required to turn on the audio unit when it is removed from the vehicle. Indication of this Security Code activation prevents your precious audio unit from stealing.



- Set the Security Code when the <Demonstration mode Setting> (page 44) is set to OFF.
- When you activate the Security Code function, it cannot be released.
Note, your Security Code is the 4 digit number entered in your "Car Audio Passport" in this package.

1 Enter Standby

Press the [SRC] button.

Select the "STANDBY" display.

2 Enter Menu mode

Press the [MENU] button for at least 1 second.

When "MENU" is displayed, "Security Set"/ "CODE SET" is displayed.

3 Enter Security Code mode

Press the Control knob for at least 1 second.

When "Enter"/ "ENTER" is displayed, "Security Set"/ "CODE" is also displayed.

4 Select the digits to enter

Push the Control knob towards [◀◀] or [▶▶].

5 Select the Security Code numbers

Push the Control knob towards [FM] or [AM].

6 Repeat steps 4 and 5, and complete the Security Code.

7 Confirm the Security Code

Press the Control knob for at least 3 seconds.

When "Re-Enter"/ "RE-ENTER" is displayed, "Security Set"/ "CODE" is also displayed.

8 Do the step 4 through 7 step operation, and reenter the security code.

"Approved"/ "APPROVED" is displayed.

The Security Code function activates.



- If you enter a Code different from your Security Code, you have to start over from step 4.

Resetting the Security Code function when the audio unit is first used after removed from the battery power source or the Reset button is pressed

1 Turn the power ON.

2 Do the step 4 through 7 step operation, and reenter the security code.

"Approved"/ "APPROVED" is displayed.

Now, you can use the unit.



- If an incorrect code is entered, "Waiting"/ "WAITING" is displayed, and the input prohibition periods shown in the table below is generated.
After the input prohibition time lapses, "Security"/ "CODE" is displayed, and you can reenter the code.

Number of times the incorrect code was input	Input prohibited time
1	—
2	5 minutes
3	1 hour
4	24 hours

In Standby mode

Touch Sensor Tone

Setting the operation check sound (beep sound) ON/OFF.

Display	Setting
"Beep : ON"/ "BEEP ON"	Beep is heard.
"Beep : OFF"/ "BEEP OFF"	Beep canceled.

Menu system

In Standby mode

Manual Clock Adjustment



- You can do this adjustment when the <Synchronize Clock> (page 36) is set as OFF.

1 Select Clock Adjustment mode

Push the Control knob towards [FM] or [AM].

Select the "Clock Adjust"/ "CLK ADJ" display.

2 Enter Clock Adjust mode

Press the Control knob for at least 1 second.

The clock display blinks.

3 Adjust the hours

Push the Control knob towards [FM] or [AM].

Adjust the minutes

Push the Control knob towards [◀◀] or

[▶▶].

4 Exit Clock adjustment mode

Press the [MENU] button.

Function of the DPX701U

In Standby mode

Date Adjustment

1 Select Date Adjust mode

Push the knob towards [FM] or [AM].

Select the "Date Adjust" display.

2 Enter Date Adjust mode

Press the Control knob for at least 1 second.

The date display blinks.

3 Selecting the item (day, month, or year) to adjust

Push the Control knob towards [◀◀] or

[▶▶].

The items that are blinking are items that you can adjust.

4 Adjust each item

Push the Control knob towards [FM] or [AM].

5 Repeat step 3 and 4 operation and adjust the date.

6 Exit Date adjustment mode

Press the [MENU] button.

Function of the DPX701U

In Standby mode

Date Mode

Setting the date format.

1 Select Date Mode

Push the Control knob towards [FM] or [AM].

Select the "Date Mode" display.

2 Select the date format

Push the Control knob towards [◀◀] or

[▶▶].

3 Exit Menu mode

Press the [MENU] button.

In Standby mode

Synchronize Clock

Synchronizing the RDS station time data and this unit's clock.

Display	Setting
"SYNC : ON" / "SYNC ON"	Synchronizes the time.
"SYNC : OFF" / "SYNC OFF"	Adjust the time manually.



- It takes 3 to 4 minutes to synchronize the clock.

In Standby mode

Indirect Lighting

You can illuminate the area around the display with soft indirect lighting.

Display	Setting
"Lighting : ON" / "LGHT ON"	Turns indirect lighting on.
"Lighting : OFF" / "LGHT OFF"	Turns indirect lighting off.

Display Illumination Control

This function turns off the display when you perform no operation for 5 seconds. This function is effective when you are driving at night.

Display	Setting
"Display : ON"/ "DISP ON"	Keeps the display on.
"Display : OFF"/ "DISP OFF"	Turns off the display when you perform no operation for 5 seconds.



- Set the Display Illumination Control when the <Demonstration mode Setting> (page 44) is set to OFF.
- When the display is off, pressing any key will turn on the display.
- When the display is off, you cannot perform any operation except for the following:
 - Volume
 - Attenuator
 - Selecting the source
 - Ejecting the disc
 - Turning off the power
- During function control, such as the Menu System, the display stays on.

In Standby mode

Dimmer

Dimming this unit's display automatically when the vehicle light switch is turned ON.

Display	Setting
"Dimmer : ON"/ "DIM ON"	The display dims.
"Dimmer : OFF"/ "DIM OFF"	The display doesn't dim.

Function of the DPX501U

In Standby mode

Switching preout

Alternating the preout between the rear and subwoofer. (With the subwoofer the sound outputs without being effected by fader control.)

Display	Setting
"SWPRE R"	Rear preout.
"SWPRE SW"	Subwoofer preout.

In Standby mode

Built-in Amp Setting

Controlling the built-in amplifier.

Turning OFF this control enhances the preout quality.

Display	Setting
"AMP : ON"/ "AMP ON"	The built-in amplifier activates.
"AMP : OFF"/ "AMP OFF"	The built-in amplifier deactivates.

Other than Standby mode/

When the Dual Zone System is ON

Dual Zone System Setting

Setting the Front channel and Rear channel sound in the Dual Zone System.

Display	Setting
"Zone2 : Rear"/ "ZONE2 R"	Sub source (Auxiliary input source) is to be rear channel.
"Zone2 : Front"/ "ZONE2 F"	Sub source (Auxiliary input source) is to be front channel.

Menu system

Other than Standby mode

B.M.S. (Bass Management System)

Adjust the bass boost level of the external amplifier using the main unit.

Display	Setting
"AMP Bass : Flat" / "BMS FLT"	Bass boost level is flat.
"AMP Bass : +6" / "BMS +6"	Bass boost level is low (+6dB).
"AMP Bass : +12" / "BMS +12"	Bass boost level is mid (+12dB).
"AMP Bass : +18" / "BMS +18"	Bass boost level is high (+18dB).



- Refer to the catalog or instruction manual for power amplifiers that can be controlled from this unit.
- For amplifiers, there are the models you can set from Flat to +18 dB, and the models you can set from Flat to +12 dB.
When an amplifier that can only be set to +12 is connected to the unit, "AMP Bass : +18" / "BMS +18" will not work correctly even if it is selected.

Other than Standby mode

B.M.S. Frequency Offset

Setting the central frequency, boosted by B.M.S.

Display	Setting
"AMP FREQ : Normal" / "BMSE NML"	Boost with the normal central frequency.
"AMP FREQ : Low" / "BMSE LOW"	Drop the normal central frequency 20%.

When LX AMP unit connecting

AMP Control

You can control the LX AMP connected to the unit.

1 Select AMP Control mode

Push the Control knob towards [FM] or [AM].

Select the "AMP Control" / "AMP CTRL" display.

2 Enter AMP Control mode

Press the Control knob for at least 1 second.

3 Select the AMP Control item for adjustment

Push the Control knob towards [FM] or [AM].



- For the details on the AMP Control item, see the Instruction manual attached to the LX AMP.

4 Adjust the AMP Control item

Push the Control knob towards [◀◀] or [▶▶].

5 Exit AMP Control mode

Press the [MENU] button.



- You cannot use the LX AMP operation during standby mode.

News Bulletin with Timeout Setting

The tuner automatically changes when a news bulletin starts even if the radio is not being listened to. Also, you can set the time interval when interruption is prohibited.

Display and Setting

"News : OFF" / "NEWS OFF"

"News : 00min" / "NEWS 00M"

⋮

"News : 90min" / "NEWS 90M"

When you set "News : 00min" / "NEWS 00M" — "News : 90min" / "NEWS 90M", the News Bulletin Interrupt function is ON.

When the News Bulletin is ON, the "NEWS" indicator is ON. (DPX501U only)

When the news bulletin starts, "NEWS" is displayed, and the tuner changes to the news bulletin.



- If you choose the "News : 20min" / "20MIN" setting, further news bulletins will not be received for 20 minutes once the first news bulletin is received.
- The news bulletin volume is the same level that was set for <Traffic Information> (page 24).
- This news bulletin function is only available if the desired station sends PTY-code for news bulletin or belongs to <Enhanced Other Network>-Network sending PTY-code for news bulletin.
- When the News Bulletin Interrupt function is ON, the tuner changes to an FM station.

In Tuner mode

Local Seek

Only stations whose reception is good are searched in auto seek tuning.

Display	Setting
"Local Seek : OFF" / "LO.S OFF"	The local seek function is OFF.
"Local Seek : ON" / "LO.S ON"	The local seek function is ON.

In Tuner mode

Tuning Mode

Sets the tuning mode.

Tuning mode	Display	Operation
Auto seek	"Seek Mode : Auto1" / "AUTO 1"	Automatic search for a station
Preset station seek	"Seek Mode : Auto2" / "AUTO 2"	Search in order of the stations in the Preset memory.
Manual	"Seek Mode : Manual" / "MANUAL"	Normal manual tuning control

AF (Alternative Frequency)

When the reception is poor, automatically alternate to another frequency broadcasting the same program in the same RDS network with better reception.

Display	Setting
"AF : ON" / "AF ON"	The AF function is ON.
"AF : OFF" / "AF OFF"	The AF function is OFF.

When the AF function is ON, the "RDS" indicator is ON.



- When no other stations with stronger reception are available for the same program in the RDS network, you may hear the incoming broadcast in bits and snatches. Turn OFF the AF function in such a case.

Menu system

Restricting RDS Region (Region Restrict Function)

You can choose whether or not to restrict the RDS channels, received with the AF function for a particular network, to a specific region.

Display	Setting
"Regional : ON"/ "REG ON"	The Region Restrict Function is ON.
"Regional : OFF"/ "REG OFF"	The Region Restrict Function is OFF.



- If AF function is not restricted to the specified region and network, the AF function sets up to search the station with good reception in the same RDS network.

Auto TP Seek

When the TI function is ON and the reception is poor while listening to a traffic information station, another traffic information station with better reception will be searched for automatically.

Display	Setting
"Auto TP Seek : ON"/ "ATPS ON"	The Auto TP Seek Function is ON.
"Auto TP Seek : OFF"/ "ATPS OFF"	The Auto TP Seek Function is OFF.

In FM reception

Monaural Reception

You can reduce the noise when stereo broadcasts are received as monaural.

Display	Setting
"MONO : OFF"/ "MONO OFF"	The monaural reception is OFF.
"MONO : ON"/ "MONO ON"	The monaural reception is ON.

External Display Control

Changing the display of the External Display connected to this unit.

Display

"DISP Out Select"/ "OEM DISP"

Each time you push the knob towards [◀◀] or [▶▶], the display switches.

Function of the DPX701U

Disc Naming (DNPS)

Attaching a title to a CD.

1 Play the disc you want to attach a name to



- A title cannot be attached to MD or Audio file media.

2 Enter Menu mode

Press the [MENU] button for at least 1 second.

"MENU" is displayed.

3 Select Name set mode

Push the Control knob towards [FM] or [AM].

Select the "Name Set" display.

4 Enter Name set mode

Press the Control knob for at least 1 second.

5 Move the cursor to the enter character position

Push the Control knob towards [◀◀] or [▶▶].

6 Select the character type

Press the Control knob.

Each time you press the knob, the character type alternates between the types shown in the table below.

Character type

Alphabet upper case

Alphabet lower case

Numbers and symbols

Special characters (Accent characters)

7 Select the characters

Push the Control knob towards [FM] or [AM].



- You can enter characters by using a remote control with a number button.
Example: If you enter "DANCE".

Character	Button	Times pressed
"D"	[3]	1
"A"	[2]	1
"N"	[6]	2
"C"	[2]	3
"E"	[3]	2

8 Repeat steps 5 through 7 and enter the name.

9 Exit Menu mode
Press the [MENU] button.

5 Select the Auxiliary input display
Push the Control knob towards [◀◀◀] or [▶▶▶].

Each time you push the knob, the display alternates as listed below.

- "AUX"/ "AUX EXT"
- "DVD"
- "PORTABLE"
- "GAME"
- "VIDEO"
- "TV"

6 Exit Menu mode
Press the [MENU] button.



- When operation stops for 10 seconds, the name at that time is registered, and the Auxiliary input display setting mode closes.
- The Auxiliary Input Display can be set only when the built-in auxiliary input or the auxiliary input of optional KCA-S210A is used.

*Function of the DPX701U (Russian sales area)
In Standby mode*

Selecting Russian Characters

Select Russian as a text display language.

Display	Setting
"Russian : ON"	Displays texts using Russian characters.
"Russian : OFF"	Displays texts using European characters.



- Texts displayed using Russian characters are as follows.
 - Folder name/ File name/ Song title/ Artist name/ Album name
- Texts cannot distinguish upper case and lower case in Russian characters.

Text Scroll

Setting the displayed text scroll.

Display	Setting
"Scroll : Manual"/ "SCL MANU"	Doesn't scroll.
"Scroll : Auto"/ "SCL AUTO"	Scrolls when the display changes.



- The text scrolled is listed below.
 - CD text
 - Folder name/ File name/ Song title/ Artist name/ Album name
 - MD title
 - Radio text

In Standby mode

Built-in Auxiliary input Setting

Set the Built-in Auxiliary Input function.

Display	Setting
"Built in AUX : OFF"/ "AUX OFF"	When selecting the source there's no Auxiliary Input.
"Built in AUX : ON"/ "AUX ON"	When selecting the source there's Auxiliary Input.

In Standby mode

Power OFF Timer

Setting the timer to turn this unit's power OFF automatically when Standby mode continues. Using this setting can save the vehicle's battery power.

Display	Setting
"Power OFF : - - - -"/ "OFF - - -"	Power OFF Timer function is OFF.
"Power OFF : 20min"/ "OFF 20M" (Original setting)	Turns the power OFF after 20 minutes.
"Power OFF : 40min"/ "OFF 40M"	Turns the power OFF after 40 minutes.
"Power OFF : 60min"/ "OFF 60M"	Turns the power OFF after 60 minutes.



- Do this setting after setting <Security Code> (page 35).

In Standby mode

CD Read Setting

When there is a problem with playing a CD with special format, this setting plays the CD by force.

Display	Setting
"CD Read : 1"/ "CD READ 1"	Play CD and Audio file.
"CD Read : 2"/ "CD READ 2"	Play CD by force.



- Setting "CD Read : 2"/ "CD READ 2" cannot play Audio file. Some music CDs may not play even in the "CD Read : 2"/ "CD READ 2" mode.

Function of ACDrive media

Voice Index

Setting the announcement during the play of ACDrive media.

Display	Setting
"Voice Index : ON"/ "V-ID ON"	Guide is announced.
"Voice Index : OFF"/ "V-ID OFF"	Not be announced.



- DPX701U (Russian sales area)
Default setting is "Voice Index : OFF"

In CD/ USB mode

ACDrive firmware version display

Displaying the firmware version with the ACDrive function.

- 1 Select the firmware version display mode**
Push the Control knob towards [FM] or [AM].
Select the "ACD F/W Version"/ "ACD VER" display.
- 2 Display the ACDrive firmware version**
Push the Control knob towards [◀◀] or [▶▶].

In CD/ USB mode

Unique ID display

Displaying the serial number for each product.

- 1 Select the unique ID display mode**
Push the Control knob towards [FM] or [AM].
Select the "ACD Unique ID"/ "ACD ID" display.
- 2 Display the unique ID**
Push the Control knob towards [◀◀] or [▶▶].

Other than Standby mode

Audio Preset Memory

Registering the value setup by Sound Control. The memory cannot be erased by the Reset button.

1 Setup Sound Control

Refer to the following operations to setup the Sound Control.

- <Audio Control> (page 47)
- <Audio Setup> (page 14)

2 Enter Menu mode

Press the [MENU] button for at least 1 second.
"MENU" is displayed.

3 Select Audio Preset mode

Push the Control knob towards [FM] or [AM].
Select the "Audio Preset"/ "A-PRESET" display.

4 Enter Audio Preset mode

Press the Control knob for at least 1 second.

5 Select the Audio Preset Memory

Push the Control knob towards [FM] or [AM].
Select the "Memory"/ "MEMORY" display.

6 Put the Audio Preset in the memory

Press the Control knob for at least 2 seconds.
The "Memory"/ "MEMORY" display blinks 1 time.

7 Exit Audio Preset mode

Press the [MENU] button.



- Register 1 pair of Audio Preset Memory. You cannot register by the source.
- When you press the Reset, all the sources will be the setting value which is registered.
- The following items cannot be registered.
Volume, Balance, Fader, Loudness, Volume offset, Dual Zone System, Rear Volum

Menu system

Other than Standby mode

Audio Preset Recall

Recalling the sound setup registered by <Audio Preset Memory> (page 43).

- 1 Select the source**
Press the [SRC] button.
- 2 Enter Menu mode**
Press the [MENU] button for at least 1 second.
"MENU" is displayed.
- 3 Select Audio Preset mode**
Push the Control knob towards [FM] or [AM].
Select the "Audio Preset"/ "A-PRESET" display.
- 4 Enter Audio Preset mode**
Press the Control knob for at least 1 second.
- 5 Select the Audio Preset Recall**
Push the Control knob towards [FM] or [AM].
Select the "Recall"/"RECALL" display.
- 6 Recall the Audio Preset**
Press the Control knob for at least 2 seconds.
The "Recall"/"RECALL" display blinks 1 time.
- 7 Exit Audio Preset mode**
Press the [MENU] button.



- The User memory of <System Q> (page 12) is changed to the value which was recalled.
- The source tone memory item of <Audio Control> (page 47) is changed to the value which was recalled by the selected source.

In Standby mode

Demonstration mode Setting

Sets the demonstration mode.

- 1 Select the Demonstration mode**
Push the Control knob towards [FM] or [AM].
Select the "DEMO Mode"/ "DEMO" display.
- 2 Set the Demonstration mode**
Press the Control knob for at least 2 seconds.
Each time you press the knob at least 2 seconds, the Demonstration mode alternates between the settings shown in the table below.

Display	Setting
"DEMO Mode : ON"/ "DEMO ON"	The Demonstration mode function is ON.
"DEMO Mode : OFF"/ "DEMO OFF"	Exit Demonstration mode (Normal mode).

Basic Operations of remote control

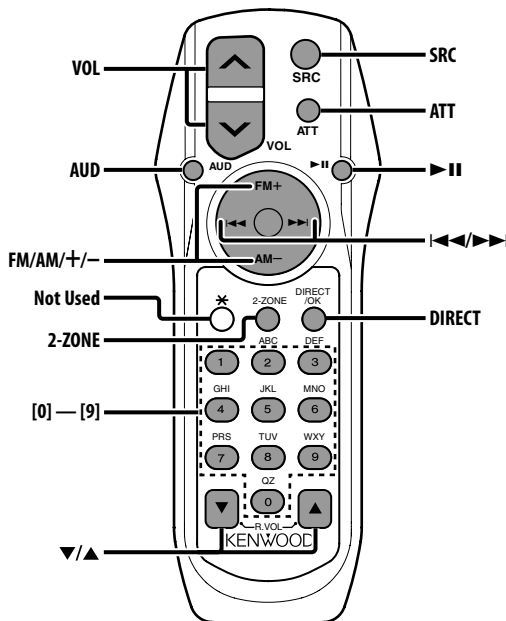

Loading and Replacing the battery

Use two "AA"/ "R6"-size batteries.
 Slide the cover while pressing downwards to remove it as illustrated.
 Insert the batteries with the + and - poles aligned properly, following the illustration inside the case.

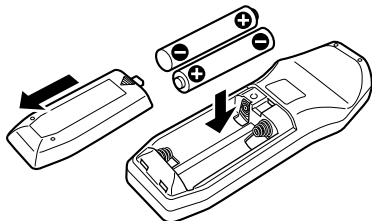

▲WARNING

- Store unused batteries out of the reach of children. Contact a doctor immediately if the battery is accidentally swallowed.



- Do not set the remote control in hot places such as on the dashboard.

Basic operations

[VOL] buttons

Adjusts the volume.

[SRC] button

Each time you press the button, the source alternates.

For the source alternating order refer to <Selecting the Source> (page 11).

[ATT] button

Turns the volume down quickly. When the button is pressed again, the volume returns to the previous level.

Audio Control

[AUD] button

Selects the Audio item to be adjusted.

[VOL] buttons

Adjusts the Audio item.



- Refer to <Audio Control> (page 47) for the operation method, such as the procedures for Audio control and others operations.
- The remote control can only select and adjust the Basic Audio item. Selecting and adjusting of the Detail Audio item cannot be done.

Dual Zone System

[2-ZONE] button

Each time you press the button, "2 ZONE" of <Audio Setup> (page 14) is turned ON or OFF.

[▲]/ [▼] buttons

Adjusts the volume of the rear channel.
The rear channel activates while the Dual Zone System is ON.

In Tuner source

[FM]/ [AM] buttons

Selects the band.
Each time you press the [FM] button, the band alternates between the FM1, FM2, and FM3 bands.

[|◀◀|/ [▶▶|] buttons

Tune up or down band.

[0] — [9] buttons

Press buttons [1] — [6] to recall preset stations.

[DIRECT] button

Enters and cancels the <Direct Access Tuning> (page 22) mode.

[▶ II] button

Enters and cancels the <PTY (Program Type)> (page 25) mode.

In Disc/USB source

[|◀◀|/ [▶▶|] buttons

Going forwards and backwards between track/ files.

[+]/ [-] buttons

Going forwards and backwards between disc/ folders.

[▶ II] button

Each time you press the button, the song pauses or plays.

[0] — [9] buttons

When in <Direct Track/File Search> (page 29) and <Direct Disc Search> (page 29), enters the track/ file/disc number.

Accessories/ Installation Procedure

Accessories

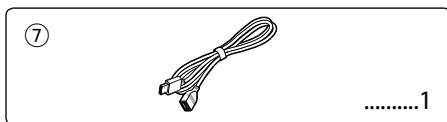
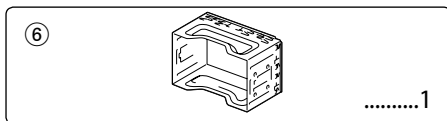
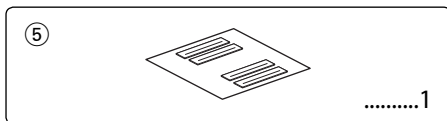
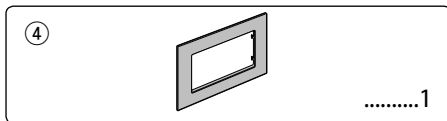
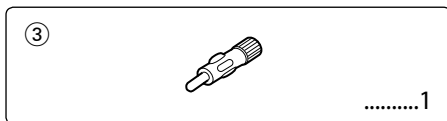
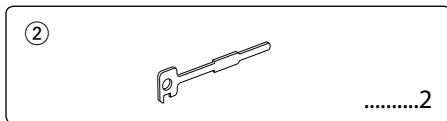
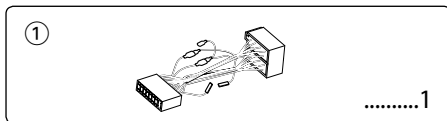

Installation Procedure

1. To prevent short circuits, remove the key from the ignition and disconnect the \ominus terminal of the battery.
2. Make the proper input and output wire connections for each unit.
3. Connect the wire on the wiring harness.
4. Take Connector B on the wiring harness and connect it to the speaker connector in your vehicle.

5. Take Connector A on the wiring harness and connect it to the external power connector on your vehicle.
6. Connect the wiring harness connector to the unit.
7. Install the unit in your car.
8. Reconnect the \ominus terminal of the battery.
9. Press the reset button.



- If the power is not turned ON (or it is ON, but will be OFF immediately), the speaker wire may have a short-circuit or touched the chassis of the vehicle and the protection function may have been activated. Therefore, the speaker wire should be checked.
- If your car is not prepared for this special connection-system, consult your Kenwood dealer.
- Only use antenna conversion adapters (ISO-JASO) when the antenna cord has an ISO plug.
- Make sure that all wire connections are securely made by inserting jacks until they lock completely.
- If your vehicle's ignition does not have an ACC position, or if the ignition wire is connected to a power source with constant voltage such as a battery wire, the power will not be linked with the ignition (i.e., it will not turn on and off along with the ignition). If you want to link the unit's power with the ignition, connect the ignition wire to a power source that can be turned on and off with the ignition key.
- If the fuse blows, first make sure that the wires have not caused a short circuit, then replace the old fuse with one with the same rating.
- Insulate unconnected wires with vinyl tape or other similar material. To prevent short circuits, also do not remove the caps on the ends of the unconnected wires or the terminals.
- Connect the speaker wires correctly to the terminals to which they correspond. The unit may receive damage or fail to work if you share the \ominus wires and/or ground them to any metal part in the car.
- After the unit is installed, check whether the brake lamps, indicators, wipers, etc. on the car are working properly.
- If the console has a lid, make sure to install the unit so that the faceplate does not hit the lid when closing and opening.
- Mount the unit so that the mounting angle is 30° or less.

Connecting Wires to Terminals

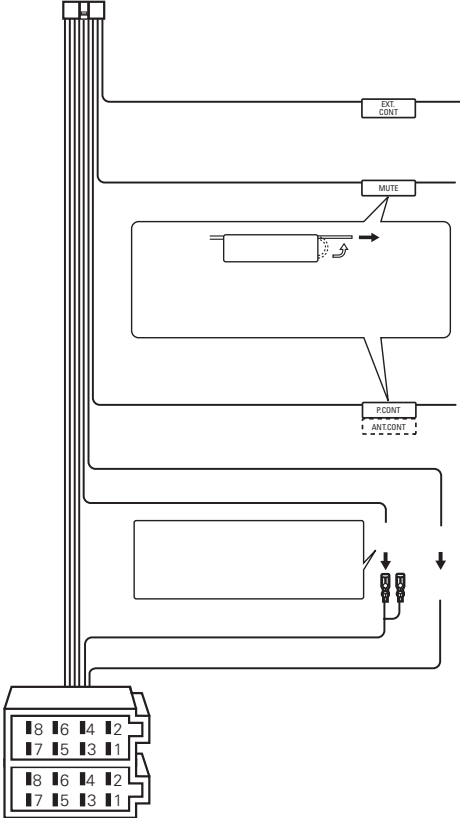

Connecting Wires to Terminals

Connector Function Guide

Pin Numbers for ISO Connectors	Cable Colour	Functions
External Power Connector		
A-4	Yellow	Battery
A-5	Blue/White	Power Control
A-6	Orange/White	Dimmer
A-7	Red	Ignition (ACC)
A-8	Black	Earth (Ground) Connection
Speaker Connector		
B-1	Purple	Rear Right (+)
B-2	Purple/Black	Rear Right (-)
B-3	Gray	Front Right (+)
B-4	Gray/Black	Front Right (-)
B-5	White	Front Left (+)
B-6	White/Black	Front Left (-)
B-7	Green	Rear Left (+)
B-8	Green/Black	Rear Left (-)

▲WARNING

Connecting the ISO Connector

The pin arrangement for the ISO connectors depends on the type of vehicle you drive. Make sure to make the proper connections to prevent damage to the unit. The default connection for the wiring harness is described in [1] below. If the ISO connector pins are set as described in [2] or [3], make the connection as illustrated. Please be sure to reconnect the cable as shown [2] below to install this unit to the **Volkswagen** vehicles etc.

[1] (Default setting) The A-7 pin (red) of the vehicle's ISO connector is linked with the ignition, and the A-4 pin (yellow) is connected to the constant power supply.

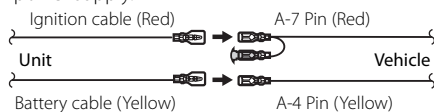

[2] The A-7 pin (red) of the vehicle's ISO connector is connected to the constant power supply, and the A-4 pin (yellow) is linked to the ignition.

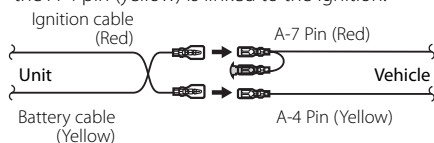

[3] The A-4 pin (yellow) of the vehicle's ISO connector is not connected to anything, while the A-7 pin (red) is connected to the constant power supply (or both the A-7 (red) and A-4 (yellow) pins are connected to the constant power supply).

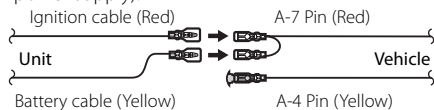

- When the connection is made as in [3] above, the unit's power will not be linked to the ignition key. For that reason, always make sure to turn off the unit's power when the ignition is turned off.

To link the unit's power to the ignition, connect the ignition cable (ACC...red) to a power source that can be turned on and off with the ignition key.

Installing the Escutcheon

For General Motors

- 1 Refer to the section <Removing the Hard Rubber Frame> (page 53) and then remove the hard rubber frame.
- 2 Cut out accessory ④ to meet the shape of the opening of the center console.
- 3 Attach accessory ④ to the unit.

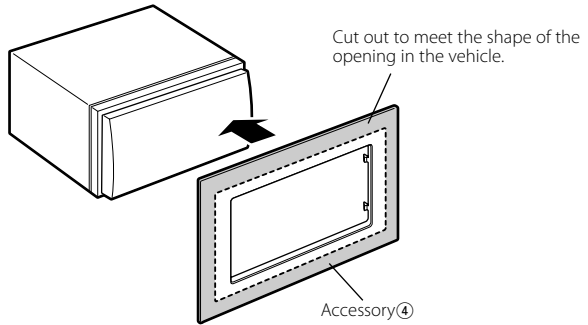

For TOYOTA/ SCION

- 1 Refer to the section <Removing the Hard Rubber Frame> (page 53) and then remove the hard rubber frame.
- 2 Cut out accessory ④ as illustrated.



- When cutting out accessory ④, make sure it fits the opening of the center console.

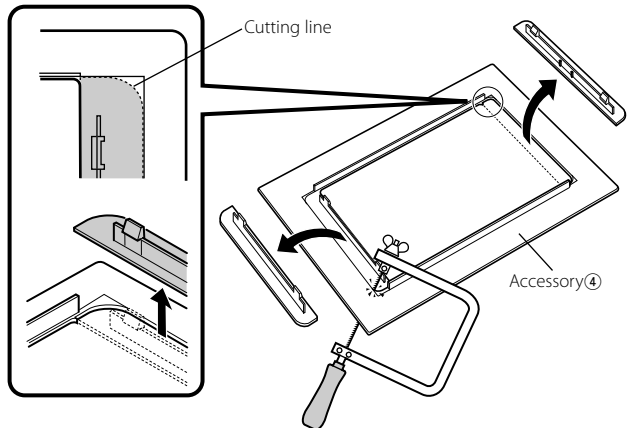

- 3 Fold double-sided adhesive (accessory ⑤) along the slit and attach it to accessory ④ cut-out against the center rib as illustrated. Use 2 pieces of accessory ⑤ for 1 accessory ④ cut-out.
- 4 Attach accessory ④ cut-out to the unit.

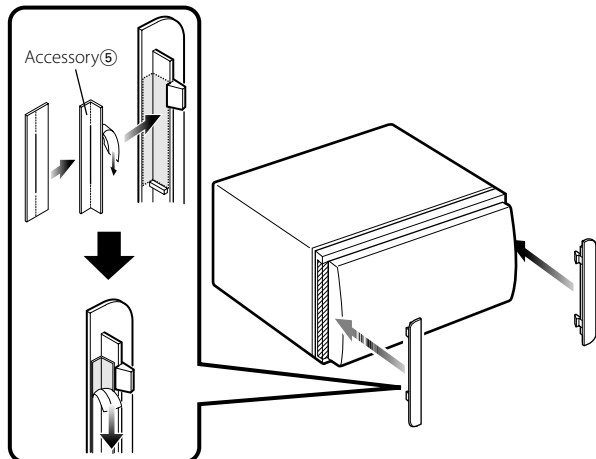

Installation

Installing the Unit

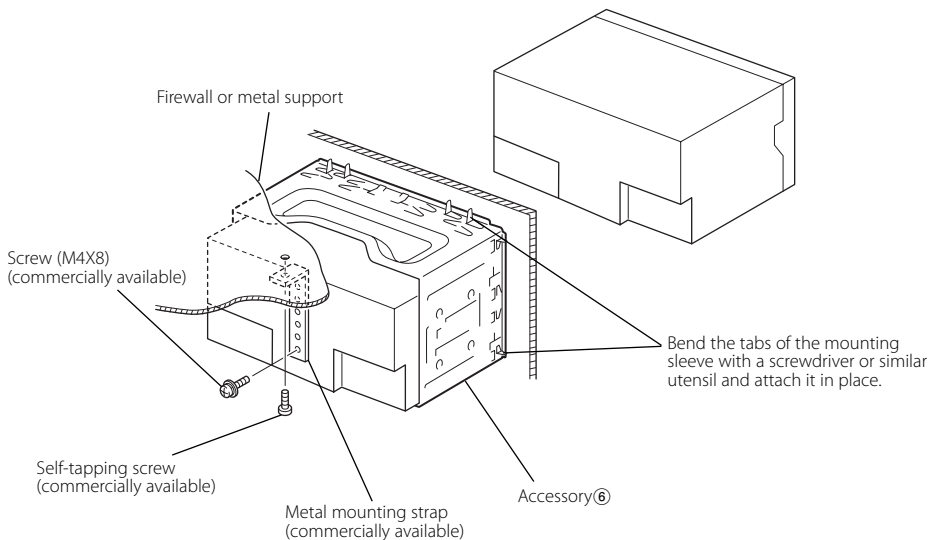

USB Device Connection

- 1 Remove the cap and connect the USB cable (Accessory ⑦).

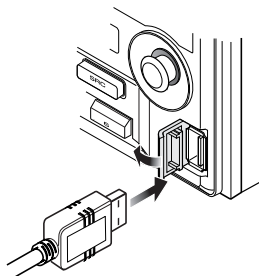

- 2 Connect the USB device to the unit using the supplied cable.

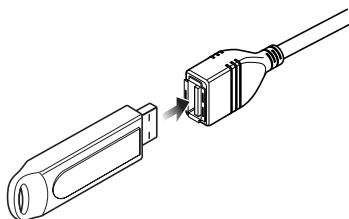

Removing the Hard Rubber Frame (escutcheon)

1 Engage the catch pins on the removal tool ② and remove the two locks on the lower level. Lower the frame and pull it forward as shown in the figure.

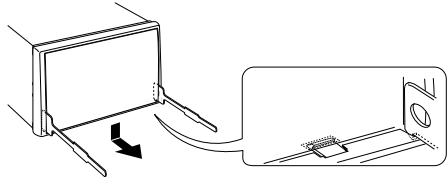

2 When the lower level is removed, remove the upper two locations.

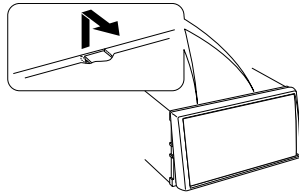

- The frame can be removed from the top side in the same manner.

Removing the Unit

1 Refer to the section <Removing the Hard Rubber Frame> and then remove the hard rubber frame.

2 Remove the Hex-head screw with integral washer (M4X8) on the back panel.

3 Insert the two removal tools ② deeply into the slots on each side, as shown.

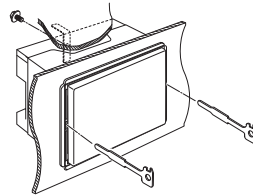

4 Lower the removal tool towards the bottom, and pull out the unit halfway while pressing towards the inside.



- Be careful to avoid injury from the catch pins on the removal tool.

5 Pull the unit all the way out with your hands, carefully not to drop it.

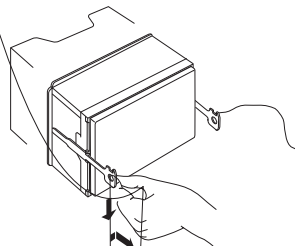

Troubleshooting Guide

What might seem to be a malfunction in your unit may just be the result of slight misoperation or miswiring. Before calling service, first check the following table for possible problems.

General

? The power does not turn ON.

- ✓ The fuse has blown.
 - ☞ After checking for short circuits in the wires, replace the fuse with one with the same rating.

? There's a source you can't switch.

- ✓ There's no media inserted.
 - ☞ Set the media you want to listen to. If there's no media in this unit, you can't switch to each source.
- ✓ The Disc changer isn't connected.
 - ☞ Connect the Disc changer. If the Disc changer isn't connected to its input terminal, You can't switch to an external disc source.

? The memory is erased when the ignition is turned OFF.

- ✓ The ignition and battery wire are incorrectly connected.
 - ☞ Connect the wire correctly, referring to the section on <Connecting Wires to Terminals>.

? There's no loudness effect.

- ✓ You're using Subwoofer preout.
 - ☞ Loudness has no effect in Subwoofer preout.

? The TEL mute function does not work.

- ✓ The TEL mute wire is not connected properly.
 - ☞ Connect the wire correctly, referring to the section on <Connecting Wires to Terminals>.

? The TEL mute function turns ON even though the TEL mute wire is not connected.

- ✓ The TEL mute wire is touching a metal part of the car.
 - ☞ Pull the TEL mute wire away from the metal part of the car.

? Even if Loudness is turned ON, high-pitched tone isn't compensated for.

- ✓ Tuner source is selected.
 - ☞ High-pitched tone isn't compensated for when in Tuner source.

? No sound can be heard, or the volume is low.

- ✓ The fader or balance settings are set all the way to one side.
 - ☞ Center the fader and balance settings.
- ✓ The input/output wires or wiring harness are connected incorrectly.
 - ☞ Reconnect the input/output wires or the wiring harness correctly. See the section on <Connecting Wires to Terminals>.
- ✓ The values of Volume offset are low.
 - ☞ Turn up the Volume offset, referring to the section on <Audio Setup> (page 14).
- ✓ The <Built-in Amp Setting> (page 37) is OFF.
 - ☞ Turn it ON.

? The sound quality is poor or distorted.

- ✓ One of the speaker wires is being pinched by a screw in the car.
 - ☞ Check the speaker wiring.
- ✓ The speakers are not wired correctly.
 - ☞ Reconnect the speaker wires so that each output terminal is connected to a different speaker.

? The Touch Sensor Tone doesn't sound.

- ✓ The preout jack is being used.
 - ☞ The Touch Sensor Tone can't be output from the preout jack.
- ✓ The <Touch Sensor Tone> (page 35) is OFF.
 - ☞ Turn it ON.

? Even though Synchronize Clock is ON, the clock can't be adjusted.

- ✓ The received RDS station isn't sending time data.
 - ☞ Receive another RDS station.

? The Dimmer function does not work.

- ✓ The Dimmer wire is not connected correctly.
 - ☞ Check the Dimmer wire connection.
- ✓ The <Dimmer> (page 37) is OFF.
 - ☞ Turn it ON.

? The sound is not output from Subwoofer or it outputs the different sound.

- ✓ When "2 ZONE"/"2ZON" of <Audio Setup> (page 14) is set to ON.
 - ☞ Set "2 ZONE" of <Audio Setup> to OFF.

? Cannot display the Russian characters.

- ✓ ---
 - ☞ Refer to <Selecting Russian Characters> (page 41).

? The display blacks out while scrolling.

- ✓ <Display Illumination Control> is set to OFF.
 - ☞ Refer to <Display Illumination Control> (page 37).

Tuner source

? Radio reception is poor.

- ✓ The car antenna is not extended.
E38 Pull the antenna out all the way.
- ✓ The antenna control wire is not connected.
E38 Connect the wire correctly, referring to the section on <Connecting Wires to Terminals>.

? The desired frequency can't be entered with the Direct Access Tuning.

- ✓ A station that can't be received is being entered.
E38 Enter a station that can be received.
- ✓ You're trying to enter a frequency with a 0.01 MHz unit.
E38 What can be designated in the FM band is to 0.1 MHz.

? It isn't the set Traffic information sound volume.

- ✓ The set sound volume is less than the tuner sound volume.
E38 If the tuner sound volume is louder than the set sound volume, the tuner sound volume is used.

Disc source

? "AUX EXT" is displayed without achieving External disc control mode.

- ✓ Unsupported disc changer is connected.
E38 Use the disc changer mentioned in the <About CD players/disc changers connected to this unit> (page 4) of the section on <Safety precautions>.

? The specified disc does not play, but another one plays instead.

- ✓ The specified CD is quite dirty.
E38 Clean the CD.
- ✓ The disc is loaded in a different slot from that specified.
E38 Eject the disc magazine and check the number for the specified disc.
- ✓ The disc is severely scratched.
E38 Try another disc instead.

? A CD ejects as soon as it is loaded.

- ✓ The CD is quite dirty.
E38 Clean the CD, referring to the CD cleaning of the section on <About CDs> (page 7).

? Can't remove disc.

- ✓ The cause is that more than 10 minutes has elapsed since the vehicle ACC switch was turned OFF.
E38 The disc can only be removed within 10 minutes of the ACC switch being turned OFF. If more than 10 minutes has elapsed, turn the ACC switch ON again and press the Eject button.

? The disc won't insert.

- ✓ There's already another disc inserted.
E38 Press the [▲] button and remove the disc.

? Direct Search can't be done.

- ✓ Another function is ON.
E38 Turn Random Play or other functions OFF.

? Track Search can't be done.

- ✓ For the discs/folders first or last song.
E38 For each disc/folder, Track Search can't be done in the backward direction for the first song or in the forward direction for the last song.

Troubleshooting Guide

Audio file source

? Cannot play an Audio file.

- ✓ The media is scratched or dirty.
 - ☞ Clean the media, referring to the CD cleaning of the section on <About CDs> (page 7).

? The sound skips when an Audio file is being played.

- ✓ The media is scratched or dirty.
 - ☞ Clean the media, referring to the CD cleaning of the section on <About CDs> (page 7).
- ✓ The recording condition is bad.
 - ☞ Record the media again or use another media.

? The Audio file track time isn't displayed correctly.

- ✓ ---
 - ☞ There are times when it isn't displayed correctly according to the Audio file recording conditions.

USB device source

? The USB device is not detected.

- ✓ The USB connector is disconnected.
 - ☞ Connect the connector of the USB device properly.

? The USB device does not play its audio files.

- ✓ The USB connector is disconnected.
 - ☞ Connect the connector of the USB device properly.

The messages shown below display your systems condition.

Eject/ EJECT: No disc magazine has been loaded in the changer. The disc magazine is not completely loaded.

- ☞ Load the disc magazine properly.
- No CD in the unit.
- ☞ Insert the CD.

No Disc/ NO DISC: No disc has been loaded in the disc magazine.

- ☞ Load a disc into the disc magazine.

TOC Error/ TOC ERR: No disc has been loaded in the disc magazine.

- ☞ Load a disc into the disc magazine. The CD is quite dirty. The CD is upside-down. The CD is scratched a lot.
- ☞ Clean the CD and load it correctly.

Read Error/ READ ERR:

- The number of files or folders which are stored in the connected USB device is above the limitation.
- The file system of the connected USB device is broken.
- ☞ Copy the files and folders for the USB device again referring to www.kenwood.mediamanager.jp. If the error message is still displayed, initialize the USB device or use other USB devices.

Error 05/ E-05: The CD is upside-down.

- ☞ Load the CD correctly.

Blank Disc/ BLANK: Nothing has been recorded on the MD.

No Track/ NO TRACK: No tracks are recorded on the MD, although it has a title.

Error 15/ E-15: Media was played that doesn't have data recorded that the unit can play.

- ☞ Use media that has data recorded that the unit can play.

No Panel/ NO PANEL: The faceplate of the slave unit being connected to this unit has been removed.

- ☞ Replace it.

Error 77/ E-77: The unit is malfunctioning for some reason.

- ☞ Press the reset button on the unit. If the "Error 77/ E-77" code does not disappear, consult your nearest service center.

Mecha Error/ E-99:	Something is wrong with the disc magazine. Or the unit is malfunctioning for some reason. <ul style="list-style-type: none"> ➤ Check the disc magazine. And then press the reset button on the unit. If the "Mecha Error/ E-99" code does not disappear, consult your nearest service center.
Hold Error/ HOLD:	The protective circuit in the unit activates when the temperature inside the automatic disc changer exceeds 60°C (140°F), stopping all operation. <ul style="list-style-type: none"> ➤ Cool down the unit by opening the windows or turning on the air conditioner. As the temperature falls below 60°C (140°F), the disc will start playing again.
No Name:	Attempted to display DNPS during the CD play having no disc names preset.
Waiting/ WAITING:	Radio text data is being received.
Load/ LOAD:	Discs are being exchanged in the Disc changer.
Reading/ READING:	The unit is reading the data on the disc.
IN (Blink):	The CD player section is not operating properly. <ul style="list-style-type: none"> ➤ Reinsert the CD. If the CD cannot be ejected or the display continues to flash even when the CD has been properly reinserted, please switch off the power and consult your nearest service center.
Protect/ PROTECT (Blink):	The speaker wire has a short-circuit or touches the chassis of the vehicle, and then the protection function is activated. <ul style="list-style-type: none"> ➤ Wire or insulate the speaker cable properly and press the reset button.
Unsupported File/ NA FILE:	An Audio file is played with a format that this unit can't support. <ul style="list-style-type: none"> ➤ ----
Copy Protection/ COPY PRO:	A copy-protected file is played. <ul style="list-style-type: none"> ➤ ----
DEMO MODE (Blink):	The Demonstration mode has been selected. <ul style="list-style-type: none"> ➤ The <Demonstration mode Setting> (page 44) is ON. Turn it OFF.
No Device/ NO DVICE:	The USB device is selected as a source although no USB device is connected. <ul style="list-style-type: none"> ➤ Change the source to any source other than USB. Connect an USB device, and change the source to USB again.
N/A Device/ NA DVICE:	An unsupported USB device is connected. <ul style="list-style-type: none"> ➤ For the supported USB devices, refer to <About USB device> (page 10).
No Music Data/ NO MUSIC:	<ul style="list-style-type: none"> • The connected USB device contains no playable audio file. • Media was played that doesn't have data recorded that the unit can play. ➤ Use media that has data recorded that the unit can play.
USB Error/ USB ERR:	The connected USB device is rated a current capacity higher than the allowable limit. <ul style="list-style-type: none"> ➤ Check the USB device with reference to <About USB device> (page 10). Some trouble may have occurred to the connected USB device. ➤ Remove the USB device and then reconnect it. When the same message displays again, use another USB device.

Specifications

Specifications subject to change without notice.

FM tuner section

Frequency range (50 kHz space)
: 87.5 MHz – 108.0 MHz
Usable sensitivity (S/N = 26dB)
: 0.7 μ V /75 Ω
Quieting Sensitivity (S/N = 46dB)
: 1.6 μ V /75 Ω
Frequency response (\pm 3.0 dB)
: 30 Hz – 15 kHz
Signal to Noise ratio (MONO)
: 65 dB
Selectivity (DIN) (\pm 400 kHz)
: \geq 80 dB
Stereo separation (1 kHz)
: 35 dB

MW tuner section

Frequency range (9 kHz space)
: 531 kHz – 1611 kHz
Usable sensitivity (S/N = 20dB)
: 25 μ V

LW tuner section

Frequency range
: 153 kHz – 281 kHz
Usable sensitivity (S/N = 20dB)
: 45 μ V

CD player section

Laser diode
: GaAlAs
Digital filter (D/A)
: 8 Times Over Sampling
D/A Converter
: 1 Bit
Spindle speed (Audio file)
: 500 – 200 rpm (CLV)
Wow & Flutter
: Below Measurable Limit
Frequency response (\pm 1 dB)
: 10 Hz – 20 kHz
Total harmonic distortion (1 kHz)
: 0.008 %
Signal to Noise ratio (1 kHz)
DPX701U: 110 dB
DPX501U: 105 dB
Dynamic range
: 93 dB
MP3 decode
: Compliant with MPEG-1/2 Audio Layer-3
WMA decode
: Compliant with Windows Media Audio

AAC decode
: AAC-LC ".m4a" files

USB Interface

USB Standard
: USB 1.1/ 2.0
Maximum Supply current
: 500 mA
File System
: FAT16/ 32
MP3 decode
: Compliant with MPEG-1/2 Audio Layer-3
WMA decode
: Compliant with Windows Media Audio
AAC decode
: AAC-LC ".m4a" files

Audio section

Maximum output power
: 50 W x 4
Output power (DIN 45324, +B=14.4V)
: 30 W x 4
Speaker impedance
: 4 – 8 Ω
Tone action
Bass : 100 Hz \pm 8 dB
Middle : 1 kHz \pm 8 dB
Treble : 10 kHz \pm 8 dB
Preout level / Load
DPX701U: 5000 mV/10 k Ω (during disc play)
DPX501U: 2500 mV/10 k Ω
Preout impedance
DPX701U: \leq 80 Ω
DPX501U: \leq 600 Ω

Auxiliary input

Frequency response (\pm 1 dB)
: 20 Hz – 20 kHz
Input Maximum Voltage
: 1200 mV
Input Impedance
: 100 k Ω

General

Operating voltage (11 – 16V allowable)
: 14.4 V
Current consumption
: 10 A
Installation Size (W x H x D)
: 182 x 112 x 159 mm
Weight
DPX701U: 1.64 kg
DPX501U: 1.60 kg

KENWOOD