

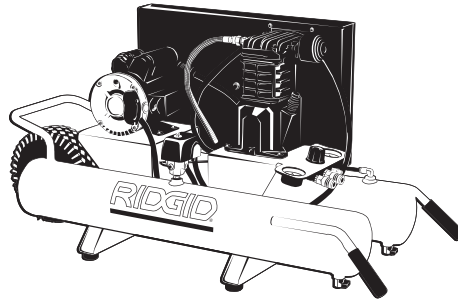

OL90150
OPERATOR'S MANUAL



WHEELBARROW
AIR
COMPRESSOR

⚠WARNING:

To reduce the risk of injury, the user must read and understand the Operator's Manual before using this product.

IN614300AV 9/04

Printed in U.S.A.

Table of Contents

Section	Page	Section	Page
Table of Contents	2	Installation	11
Safety Instructions	3	Getting to Know Your Air Compressor	12
Safety Signal Words	3	Operating Your Air Compressor ...	14
Before Using the Air Compressor	3	Moisture in Compressed Air	14
Spraying Precautions	5	Lubrication	14
Breathable Air Warning	5	Operating Your Air Compressor ...	15
Warning Labels	6	For Trouble-Free Operation	16
Motor Specifications and Electrical Requirements	7	Maintenance	17
Power Supply and Motor Specifications	7	Tank	18
General Electrical Connections	7	Filter Removal, Inspection, and Replacement	18
110-120 Volt, 60 Hz Tool Information	8	Drive Belt	18
Extension Cords	8	Storage	19
Changing Motor Voltage	9	Maintenance Schedule	19
Thermal Overload Protector	10	Troubleshooting	20
Glossary of Terms	10	Repair Parts	24
Unpacking and Checking Contents	11	Warranty	28

Safety Instructions

This manual contains information that is very important to know and understand. This information is provided for SAFETY and to PREVENT EQUIPMENT PROBLEMS. To help recognize this information, observe the following symbols.

Safety Signal Words

▲DANGER: Danger indicates an imminently hazardous situation which, if not avoided, WILL result in death or serious injury.

▲WARNING: Warning indicates a potentially hazardous situation which, if not avoided, COULD result in death or serious injury.

▲CAUTION: Caution indicates a potentially hazardous situation which, if not avoided, MAY result in minor or moderate injury.

NOTICE: Notice indicates important information, that if not followed, may cause damage to equipment.

Before Using the Air Compressor

Since air compressors and other components (material pump, spray gun, filters, lubrications, hoses, etc.) used make up a high pressure pumping system, the following safety precautions should be observed at all times. Only persons well acquainted with these rules of safe operation should be allowed to use the air compressor.

▲WARNING:

All electrical work should be done by a qualified (licensed or certified) electrician. On a properly wired circuit, the black wires supply a voltage potential even when the unit is off.

1. Read instruction manuals for each component carefully, before attempting to assemble, disassemble or operate your particular system.
2. Wear safety glasses (meeting ANSI Z87.1 or in Canada CSA Z94.3-99) and use hearing protection when operating the pump or unit. Everyday glasses are not safety glasses.
3. Do not exceed pressure rating of any component in system.

4. Protect material lines and air lines from damage or puncture. Keep hose and power cable away from sharp objects, chemical spills, oil, solvents, and wet floors.
5. Never point a spray gun at oneself or any other person. Accidental discharge may result in serious injury.
6. Check hoses for weak or worn condition before each use, making certain all connections are secure; do not use if deficiency is found. Notify an authorized service facility for examination or repair.
7. Release all pressures within system slowly; dust and debris may be harmful.

▲WARNING:

Disconnect power and depressurize system before servicing air compressor! (Turn pressure regulator knob fully clockwise after shutting off compressor.)

Safety Instructions (continued) ---

8. Follow all local electrical and safety codes, as well as the National Electrical Code (NEC) and the Occupational Safety and Health Act (OSHA).
9. Wiring and fuses should follow electrical codes, current capacity, and be properly grounded.
10. Electric motors must be securely and adequately grounded. See grounding instructions and extension cord information in this manual.
11. Always disconnect power source before working on or near a motor, or its connected load. If power disconnect point is out-of-sight, lock it in the open position and tag to prevent unexpected application of power.
12. Guard all moving parts; keep visitors away. Never allow children in work area.
13. Use only a properly grounded outlet that will accept a three pronged plug, and wear shoes to prevent shock hazards.
14. Be careful when touching exterior of operating motor; it may be hot enough to cause injury.
15. Protect power cable from coming in contact with sharp objects.
16. Clean electrical or electronic equipment with an approved cleaning agent, such as dry, nonflammable cleaning solvent.
17. To avoid spontaneous combustion, discard waste rags into approved metal waste cans.
18. Never store flammable liquids or gases in vicinity of compressor.
19. When spraying with solvent or toxic chemicals, follow instructions provided by the chemical manufacturer.
20. Spray in a well ventilated area, to keep fumes from collecting and causing health and fire hazards.
21. Do not spray in vicinity of open flames or other places where a spark can cause ignition. Do not smoke when spraying paint, insecticides, or other flammable substances.
22. Use a respirator when spraying.
23. NEVER reset safety valve or pressure switch. Keep safety valve free from paint and other accumulations. This provides safety against over pressure.
24. Do regular maintenance; keep all nuts, bolts, and screws tight, to be sure equipment is in safe working condition .
25. Keep cleaning rags and other flammable waste materials in a tightly closed metal container and dispose of later in the proper fashion.
26. Drain tanks of moisture after each day's use. If unit will not be used for a while, it is best to leave drain cock open until such time as it is to be used. This will allow moisture to completely drain out and help prevent corrosion of inside of tank.
27. Inspect tank yearly for rust, pin holes or any other imperfections that could cause it to become unsafe. NEVER weld or drill holes in air tank.
28. Do not wear loose clothing or jewelry that will get caught in the moving parts of the unit.

Spraying Precautions

⚠WARNING:

Do not spray flammable materials in vicinity of open flame or near ignition sources including the compressor unit.



1. Do not smoke when spraying paint, insecticides, or other flammable substances.

2. Use a face mask/respirator when spraying and spray in a well ventilated area to prevent health and fire hazards.



3. Do not direct paint or other sprayed material at the compressor. Locate compressor as far away from the spraying area as possible to minimize overspray accumulation on the compressor.

4. When spraying or cleaning with solvents or toxic chemicals, follow the instructions provided by the chemical manufacturer.

⚠DANGER:

Breathable Air Warning

This compressor/pump is not equipped and should not be used “as is” to supply breathing quality air. For any application of air for human consumption, the air compressor/pump will need to be fitted with suitable in-line safety and alarm equipment. This additional equipment is necessary to properly filter and purify the air to meet minimal specifications for Grade D breathing as described in Compressed Gas Association Commodity Specification G 7.1 - 1966, OSHA 29 CFR 1910. 134, and/or Canadian Standards Associations (CSA).

DISCLAIMER OF WARRANTIES

In the event the compressor is used for the purpose of breathing air application and proper in-line safety and alarm equipment is not simultaneously used, existing warranties shall be voided, and Campbell Hausfeld disclaims any liability whatsoever for any loss, personal injury or damage.

Safety Instructions (continued)

Warning Labels

Find and read all warning labels found on the air compressor shown below

⚠ WARNING

DRAIN TANK EVERY DAY TO PREVENT CORROSION AND POSSIBLE INJURY DUE TO TANK DAMAGE.

⚠ AVERTISSEMENT

PURGER LE RESERVOIR QUOTIDIENNEMENT AFIN D'ÉVITER LA CORROSION ET LE RISQUE DE BLESSURES CAUSE PAR LE DOMMAGE AU RESERVOIR















⚠ ADVERTENCIA

DRENE EL TANQUE DIARIAMENTE PARA EVITAR QUE SE OXIDE Y EL RIESGO DE HÉRIDAS DEBIDO A UN TANQUE DANADO.

VALVE BELOW
AOUPAPE CI-DESSOUS
VALVULA ABAJO



TO OPEN
POUR OUVRIIR
PARA ABIR

⚠ WARNING	⚠ AVERTISSEMENT	⚠ ADVERTENCIA
<p> READ INSTRUCTION MANUAL BEFORE OPERATING.</p>	<p> LIRE LE MANUEL D'UTILISATION AVANT DE FAIRE FONCTIONNER LE MODÈLE.</p>	<p> LEA EL MANUAL DE INSTRUCCIONES ANTE DE OPERAR.</p>
<p> RISK OF FIRE OR EXPLOSION - DO NOT SPRAY COMBUSTIBLE/FLAMMABLE LIQUID IN A CONFINED AREA. SPRAY AREA MUST BE WELL VENTILATED. DO NOT SMOKE WHILE SPRAYING OR SPRAY WHERE SPARK OR FLAME IS PRESENT. ARCING PARTS - KEEP COMPRESSOR AT LEAST 20 FEET AWAY FROM SPRAYING AREA AND ALL EXPLOSIVE VAPOURS.</p>	<p> RISQUE D'INCENDIE OU D'EXPLOSION - NE PAS PULVÉRISER LES LIQUIDES COMBUSTIBLES/INFLAMMABLES DANS UN ENDRIT CLOS. L'ENDROIT DE PULVÉRISATION DOIT ÊTRE BIEN VENTILÉ. NE PAS FUMER PENDANT LA PULVÉRISATION NI PULVÉRISER DANS L'ENDROIT D'UNE FLAMME OU D'UNE ÉTINCELLE. PIÈCES QUI PROJettent DES ÉTINCELLES - GARDER LE COMPRESSEUR AU MOINS 6.1 M. DE L'ENDROIT DE PULVÉRISATION ET DE TOUTES VAPEURS EXPLOSIVES.</p>	<p> RIESGO DE INCENDIO O EXPLOSIÓN - NO ROCE LÍQUIDOS COMBUSTIBLES/INFLAMMABLES EN UN ÁREA ENCERRADA. EL ÁREA DE TRABAJO DEBE ESTAR BIEN VENTILADA. NO FUME MIENTRAS ESTE ROCIANDO NI ROCE CERCA DE CHISPAS O LLAMAS. PIEZAS QUE PRODUCEN ARCOS ELÉCTRICOS-MANTENGA EL COMPRESOR AL MENOS A 6.1 M. DE DISTANCIA DEL ÁREA DONDE ESTE ROCIANDO O DE DONDE HAYA CUALQUIER TIPO DE VAPORES EXPLOSIVOS.</p>
<p> RISK OF INJURY - DO NOT DIRECT AIR STREAM AT BODY. USE EYE PROTECTION. COMPRESSOR STARTS AUTOMATICALLY. MOVING PARTS. DO NOT TOUCH. KEEP GUARDS IN PLACE. COMPRESSOR DOES NOT SUPPLY BREATHABLE AIR.</p>	<p> RISQUE DE BLESSURE - NE PAS DIRIGER LE JET D'AIR VERS VOTRE CORPS. UTILISER LA PROTECTION OCULAIRE. LE COMPRESSEUR SE DÉMARTE AUTOMATIQUÉMENT. PIÈCES MOBILES NY TOUCHEZ PAS. GARDER LES APPAREILS PROTÉCTEURS EN PLACE. LE COMPRESSEUR NE FOURNIT PAS DE L'AIR RESPIRABLE.</p>	<p> RIESGO DE HÉRIDAS - NO DIRIJA EL FLUJO DE AIRE DIRECTAMENTE AL CUERPO. PROTEJASE LA VISTA. EL COMPRESOR SE ENCENDE AUTOMÁTICAMENTE. PIEZAS QUE SE MUEVEN. NO LAS TOQUE. MANTÉNGALAS PROTEGIDAS. EL COMPRESOR NO LE SUMINISTRA AIRE RESPIRABLE.</p>
<p> RISK OF BURSTING - DO NOT ADJUST REGULATOR TO RESULT IN OUTPUT PRESSURE GREATER THAN MARKED MAXIMUM PRESSURE OF ATTACHMENT IF A REGULATOR HAS NOT BEEN INSTALLED. USE ONLY ATTACHMENT RATED AT 200 PSI OR HIGHER. DO NOT WELD ON OR REPAIR TANK - REPLACE. DO NOT OPERATE WITHOUT PROPER ASME SAFETY VALVE IN PLACE.</p>	<p> RISQUE D'ÉCLATEMENT - NE PAS AJUSTER LE RÉGULATEUR AFIN D'OBTENIR UNE PRESSION DE DÉCHARGE PLUS ÉLEVÉE QUE LA PRESSION MAXIMUM DE L'ACCESSOIRE. S'IL NY A PAS DE RÉGULATEUR, UTILISER SEULEMENT LES ACCESSOIRES QUI SONT CLASSIFIÉS À 1379 kPa OU PLUS. NE PAS SOUDER SUR NI RÉPARER LE RÉSERVOIR - LE REMPLACER. NE PAS FAIRE FONCTIONNER SANS OUILE Y AIT UNE SOUPEPE DE SÛRETÉ ASME EN PLACE.</p>	<p> RIESGO DE EXPLOSIÓN - NO AJUSTE EL REGULADOR PARA OBTENER UNA PRESIÓN DE SALIDA SUPERIOR A LA INDICADA COMO PRESIÓN MÁXIMA DEL ACCESORIO. SI NO HA INSTALADO UN REGULADOR, USE SOLO ACCESORIOS DISEÑADOS PARA PRESIONES DE 13.8 BAR O MÁS. NO SUELDE NI REPARE EL TANQUE - REEMPLÁZALO. NO LO OPERE SIN HABERLE INSTALADO UNA VALVULA DE SEGURIDAD ASME ADECUADA.</p>
<p> RISK OF ELECTRICAL SHOCK - HAZARDOUS VOLTAGE. DISCONNECT FROM POWER SOURCE BEFORE SERVICING. COMPRESSOR MUST BE GROUNDED. DO NOT USE GROUNDING ADAPTORS. DO NOT EXPOSE TO RAIN, STORE INDOORS.</p>	<p> RISQUE DE SECOUSSE ÉLECTRIQUE - TENSION HASARDEUSE. DÉBRANCHER DE LA SOURCE DE PUISSANCE AVANT DE PROCÉDER À L'ENTRETIEN. LE COMPRESSEUR DOIT ÊTRE MIS À LA TERRE. NE PAS UTILISER DES ADAPTEURS DE MISE À LA TERRE. NE PAS EXPOSER À LA PLUIE. L'ENTREPOSER À L'INTÉRIEUR.</p>	<p> RIESGO DE CHOQUE ELÉCTRICO - VOLTAJE PELIGROSO. DESCONÉCTELO DEL TOMACORRIENTES ANTES DE DARLE SERVICIO. EL COMPRESOR SE DEBE CONECTAR A TIERRA. NO USE ADAPTADORES PARA CONECTARLO A TIERRA. NO LO DEJE A LA INTemperIE. ALMACÉNELO BAJO TECHO.</p>
<p>IF CONNECTED TO A CIRCUIT PROTECTED BY FUSES, USE TIME-DELAY FUSE MARKED "D".</p>	<p>SI BRANCHE À UN CIRCUIT PROTÉGÉ PAR DES FUSIBLES, UTILISER UNE FUSIBLE À RETARDÉMENT MARQUÉE "D".</p>	<p>SI LO CONECTA A UN CIRCUITO PROTEGIDO CON FUSIBLES, USE FUSIBLES DE ACCIÓN RETARADA TIPO "D".</p>
<p>COMPLIES WITH CCR462 (L)(2).</p>	<p>SE CONFORME AU CCR462 (L)(2).</p>	<p>CUMPLE CON LAS ESPECIFICACIONES CCR462 (L)(2). <small>DEC724100AV 100</small></p>

Motor Specifications and Electrical Requirements

Power Supply and Motor Specifications

⚠WARNING:

To reduce the risk of electrical hazards, fire hazards or damage to the tool, use proper circuit protection. Your tool is wired at the factory for operation using the voltage shown. Connect tool to a power line with the appropriate voltage and a 15-amp branch circuit. Use a 15-amp time delay type fuse or circuit breaker. To reduce the risk of shock or fire, if power cord is worn or cut, or damaged in any way, have it replaced immediately.

The A-C motor used on this compressor is a capacitor start, capacitor run non-reversible induction type, having the following specifications. It is wired at the factory for operation on 110V-120V AC, 60 Hz service.

Voltage	110-120	220-240
Amperes	15.0	7.5
Hertz (Cycles)	60	
Phase	Single	
RPM	3450	

General Electrical Connections

⚠DANGER:

To reduce the risk of electrocution:

1. Use only identical replacement parts when servicing. Servicing should be performed by a qualified technician.
2. Do not use in rain or where floor is wet. This tool is intended for indoor residential use only.

⚠WARNING:

Do not permit fingers to touch the terminals of plug when installing or removing the plug to or from the outlet.

Motor Specifications and Electrical Requirements (continued)

110-120 volt, 60Hz Tool Information

The plug supplied on your tool may not fit into the outlet you are planning to use. Your local electrical code may require slightly different power cord plug connections. If these differences exist refer to and make the proper adjustments per you local code before your tool is plugged in and turned on.

In the event of a malfunction or breakdown, grounding provides a path of least resistance for electrical current to reduce the risk of electric shock. This tool is equipped with an electric cord having an equipment-grounding conductor and a grounding plug, as shown. The plug must be plugged into a matching outlet that is properly installed and grounded in accordance with all local codes and ordinances.

Do not modify the plug provided. If it will not fit the outlet, have the proper outlet installed by a qualified electrician.

Improper connection of the equipment-grounding conductor can result in a risk of electric shock. The conductor with insulation having an outer surface that is green with or without yellow stripes is the equipment-grounding conductor. If repair or replacement of the electric cord or plug is necessary, do not connect the equipment-grounding conductor to a live terminal.

If the grounding instructions are not completely understood, or if you are in doubt as to whether the tool is properly grounded check with a qualified electrician or service personnel.

⚠WARNING:

If not properly grounded, this tool can cause an electrical shock, particularly when used in damp locations, in proximity of plumbing, or out of doors.

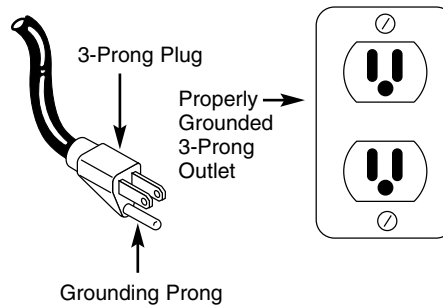

Extension Cords

1. The air compressor should be located where it can be directly plugged into an outlet. An extension cord should not be used with this unit.
2. To avoid loss of power and overheating, additional air hose must be used to reach work area instead of extension cords.

Changing Motor Voltage

NOTE: The motor is prewired at the factory for 120V operation. Use the following procedure to change motor voltage to 240V.

1. Unplug the power cord before making or modifying connections.
2. Remove the hitch pin.
3. Toggle the motor voltage selector switch from 120V to 240V.
4. Install the hitch pin.
5. Unscrew the pressure switch cover retaining screw and remove the pressure switch cover.
6. Remove the black and white wires labeled 'line' and the green ground wire. Loosen the screw for the strain relief.
7. Install a 3 wire, 240 volt, 15 amp U.L. listed cord (not provided). Be sure to connect the white and black wires to the terminals labeled 'line' and the green ground wire to the ground terminal. Also tighten the strain relief screw.
8. Install the pressure switch cover and fasten the pressure switch cover retaining screw.

The unit is now ready for 240 Volt operation.

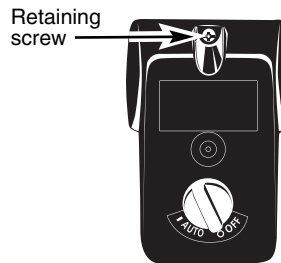
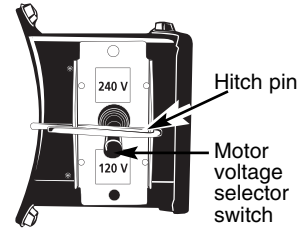

Pressure Switch Cover

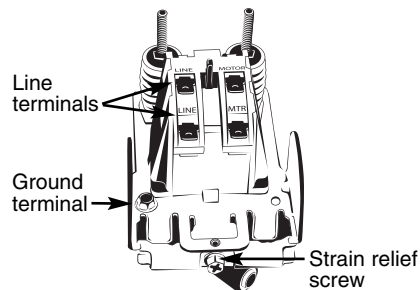

Pressure Switch

⚠WARNING:

If not properly grounded, this tool can cause an electrical shock, particularly when used in damp locations, in proximity of plumbing, or out of doors.

Motor Specifications and Electrical Requirements (continued)

Thermal Overload Protector

⚠CAUTION:

This compressor is equipped with an automatic reset thermal overload protector which will shut off motor if it becomes overheated.

If thermal overload protector shuts motor OFF frequently look for the following causes.

1. Low voltage.
2. Wrong gauge wire.
3. Clogged air filter.

4. Lack of proper ventilation.
5. Unit is being used with an extension cord.

See Troubleshooting Chart for corrective action.

⚠CAUTION:

The motor must be allowed to cool down before start-up is possible. The motor will automatically restart without warning if left plugged into electrical outlet, and the motor is turned on.

Glossary of Terms

ASME Safety Valve

A safety valve that automatically releases the air if the air receiver (tank) pressure exceeds the preset maximum.

PSI (Pounds per Square Inch)

Measurement of the pressure exerted by the force of the air. The actual psi output is measured by a pressure gauge on the compressor.

SCFM (Standard Cubic Feet per Minute)

Sometimes called CFM (Cubic Feet per Minute). Measurement of air volume delivered by the compressor.

Air Delivery

A combination of psi and SCFM. The air delivery required by a tool is stated as (number) SCFM at (number) psi. The combination of these figures determines what size unit is needed.

Air Tank Capacity

The volume of air stored in the tank and available for immediate use. A large tank allows the intermittent use of an air tool with an air requirement higher than the compressor's rated delivery.

Volts or Voltage

A measurement of the force of an electrical current.

Amps or Amperage

A measure of the electrical force minus the resistance on an electrical line. RIDGID air compressors require 15 amps for operation. Be sure the compressor will operate on an electrical line with the proper amps. If other appliances operate on the same line, they will reduce the available amps. If the amperage is not adequate, the result will be blown fuses or tripped circuits.

Glossary of Terms (continued)

Regulator

A control that adjusts the line pressure to the proper amount needed to operate spray guns and air tools.

Tank Pressure Gauge

Indicates tank pressure in psi.

Line Pressure Gauge

Displays the current line pressures. It is regulated by the regulator knob.

Cut-in/Cut-off Pressure

Specific psi at which a compressor starts and stops while refilling the air tank.

Unpacking and Checking Contents

1. Remove the air compressor from the carton.
2. Place the compressor on a secure, stationary work surface and look it over carefully.

▲WARNING:

Do not operate unit if damaged during shipping, handling or use. Damage may result in bursting and cause injury or property damage.

NOTICE:

**THIS UNIT CONTAINS NO OIL!
Follow lubrication instructions before operating compressor.**

▲WARNING:

For your own safety, never operate unit until all assembly steps are complete and until you have read and understood the entire operator's manual.

▲WARNING:

To reduce the risk of injury, if any parts are missing, do not attempt to operate the air compressor until the missing parts are obtained and installed correctly.

Installation

1. Check and tighten all bolts, fittings, etc., before operating compressor.
2. Operate compressor in a ventilated area so that compressor may be properly cooled.
3. Compressor should be located where it can be directly plugged into an outlet. An extension cord should not be used with this unit.
4. To avoid loss of power and overheating, additional air hose must be used to reach work area instead of extension cords.

Getting to Know Your Air Compressor

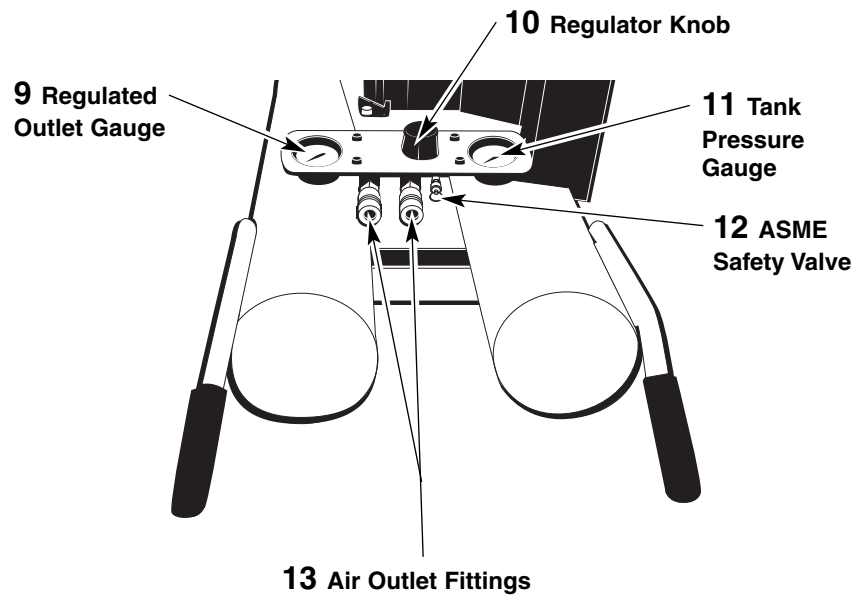
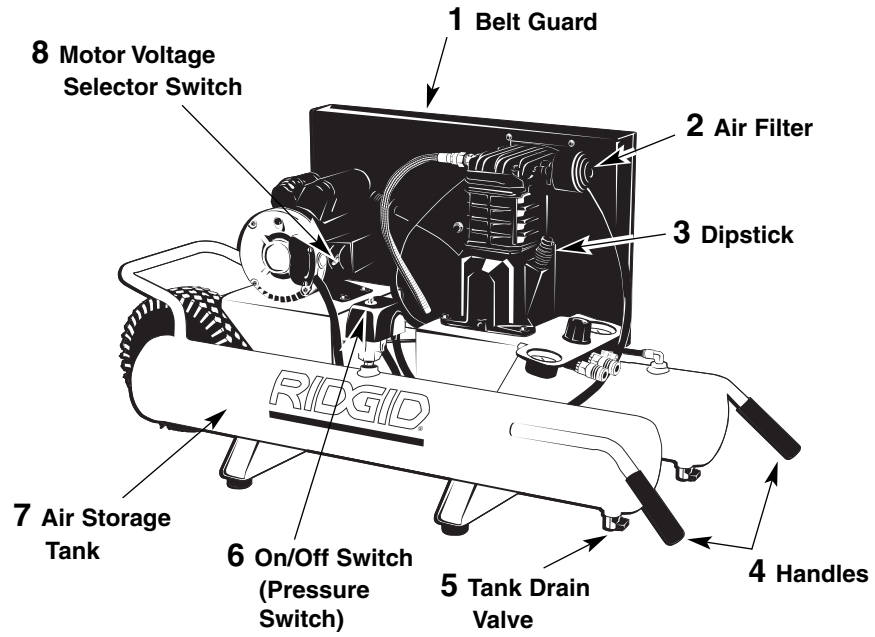

1. **Belt Guard.** The belt guard encloses the pulleys and drive belt. It protects the user from moving parts and directs cooling air to the compressor pump.
2. **Air Filter.** The air filter keeps dirt and debris from entering the compressor pump and reduces compressor noise.
3. **Dipstick.** The dipstick measures the oil level in the compressor pump.

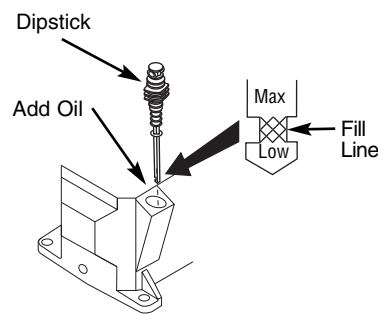

4. **Handles.** Used to move the compressor.
5. **Tank Drain Valve.** The tank drain valve allows moisture to be removed from the tank.
NOTE: Each tank has its own tank drain valve.
6. **On/Off Switch.** This switch allows for manual control of the compressor. Note that when the switch is turned on, the compressor will automatically start and stop depending on tank pressure.
7. **Air Storage Tanks.** The tanks store air for later use.
8. **Motor Voltage Selector Switch.** Allows convenient voltage change from 120 volts to 240 volts.

9. **Regulated Outlet Gauge.** This gauge shows at-a-glance, air pressure at outlet. Air pressure is measured in pounds per square inch (PSI). Most tools have maximum pressure ratings. Never exceed the maximum pressure rating of the tool you are using. Be sure this gauge reads ZERO before changing air tools or disconnecting hose from outlet.

10. **Regulator Knob.** This knob controls air pressure to an air operated tool or paint spray gun. Turning the knob clockwise increases air pressure at the outlet. Turning counterclockwise will lower air pressure at the outlet. Fully counterclockwise will shut off the flow of air completely.

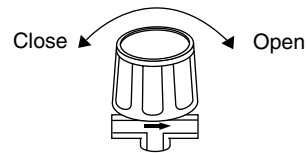

11. **Tank Pressure Gauge.** Gauge shows pressure in air storage tanks indicating compressor is building pressure properly.

12. **ASME Safety Valve.** This valve automatically releases air if the tank pressure exceeds the preset maximum.

13. **Air Outlet Fittings.** These fittings are 1/4" universal-style quick connect fittings and allow rapid tool changes.

Operating Your Air Compressor

All lubricated compressor pumps discharge some condensed water and oil with the compressed air. Install appropri-

ate water/oil removal equipment and controls as necessary for the intended application.

Moisture in Compressed Air

Moisture in compressed air will form into droplets as it comes from an air compressor pump. When humidity is high or when a compressor is in continuous use for an extended period of time, this moisture will collect in the tank. When using a paint spray or sandblast gun, this water will be carried from the tank through the hose, and out of the gun as droplets mixed with the spray material.

IMPORTANT: This condensation will cause water spots in a paint job, especially when spraying other than water based paints. If sandblasting, it will cause the sand to cake and clog the gun, rendering it ineffective.

A filter in the air line, located as near to the gun as possible, will help eliminate this moisture.

Lubrication

NOTICE:
THIS UNIT CONTAINS NO OIL!
Follow lubrication instructions
before operating compressor.

Remove the dipstick and fill pump with 12 ounces of oil. Use single viscosity, ISO 100 (SAE 30), non-detergent compressor oil; or Mobil 1® 5W30 or 10W30 synthetic oil may also be used. See illustration for proper oil fill.

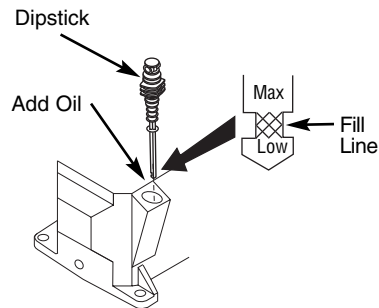

Operating Your Air Compressor

1. Remove the dipstick and fill pump to the proper oil level. See Lubrication Section.
2. Open tank drain valves and turn regulator knob counterclockwise.
3. Turn pressure switch knob to **OFF** position and plug in power cord.
4. **Follow this step only if using your compressor for the first time.** Turn pressure switch knob to **AUTO** position and run unit for 30 minutes to “break in” the pump parts.
5. Close tank drain valves and turn regulator knob fully clockwise. Compressor will build to maximum preset pressure and shut off.
6. Turn regulator knob counterclockwise to cause air to bleed off. Do not proceed to the next step until outlet pressure gauge reaches zero (0).
7. Attach hose. Add chuck or other tool to open end of hose. Turn regulator knob clockwise until desired outlet pressure is reached.
8. After use, turn pressure switch knob to the **OFF** position.
9. If compressor is not used for a long period of time, bleed air from line and use drain valve to drain water from the valves and tank. Afterwards, follow the proper schedule of maintenance.

NOTE: This unit is equipped with a pressure switch that automatically turns the motor OFF when the tank pressure reaches a preset level. After air pressure in the tank drops to a certain level, the pressure switch automatically turns the motor back on.

▲WARNING:

Do not over-pressurize any air tool. Consult air tool instructions for proper air tool pressure.

Operating Your Air Compressor (continued) ———

For Trouble-Free Operation

1. Read instructions: Carefully read through this operator's manual **BEFORE OPERATING** the new air compressor. It contains information about operation and maintenance of the unit.
2. Drain tanks daily: Depressurize system prior to draining tanks. Open tank drain valves and drain moisture from tanks. This helps prevent tank corrosion and keeps oil and moisture out of the compressed air system. Be sure to close tank drain valves before operating compressor.
3. Change air filter: Never run compressor without an air filter nor with a clogged air filter. Replace with a new filter when the element is dirty.

Maintenance

⚠WARNING:

Release all pressure and disconnect power before making any repair.

1. Check compressor for any visible problems, especially check air filter to be sure it is clean.
2. Pull ring on safety valve and allow it to snap back to normal position.

⚠WARNING:

Safety valve must be replaced if it cannot be actuated or it leaks air after ring is released.

3. Drain moisture from tanks daily. Shut compressor off. Depressurize system prior to draining tanks. Drain moisture from tanks by opening the tank drain valves underneath the tanks.

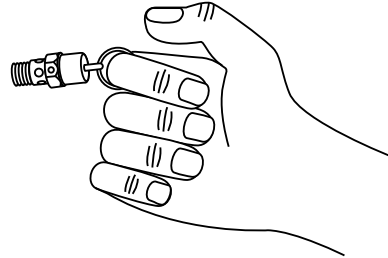

4. Turn power OFF and clean dust and dirt from motor, tank, air lines and pump cooling fins.

NOTE: The air filter in the filter housing on the side of the head must be checked and cleaned periodically, more often if used under very dusty conditions or when a great deal of fog from spraying is allowed to circulate near unit.

IMPORTANT: Unit should be located as far from spraying area as hose will allow to prevent over-spray from clogging filter.

Maintenance (continued)

Tank

⚠ DANGER:

Never attempt to repair or modify a tank! Welding, drilling or any other modification will weaken the tank resulting in damage from rupture or explosion. Always replace worn, cracked or damaged tanks.

NOTICE:

Drain liquid from tanks daily.

The tanks should be carefully inspected at a minimum of once a year. Look for cracks forming near the welds. If a crack is detected, remove pressure from tank immediately and replace.

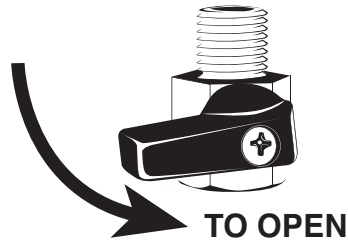
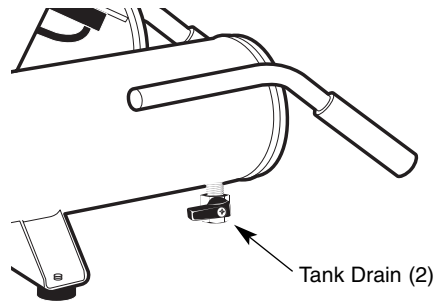

Filter Removal, Inspection and Replacement

To change a filter, pull off the filter housing cover. If filter element is dirty, replace element or entire filter.

Drive Belt

Belt stretch is a result of normal use. When properly adjusted, the belt deflects about 1/2" with five pounds of pressure applied midway between the motor pulley and pump.

To adjust drive belt tension:

1. Before servicing, put on ANSI Z87.1-approved eye protection. Turn off and unplug compressor. Drain all moisture and air from unit by fully opening tank drain valve.

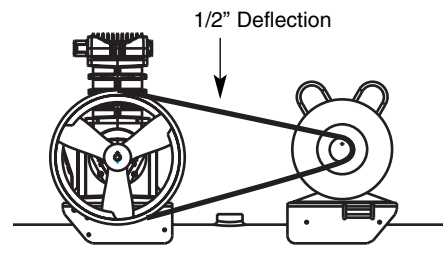

2. With a marker, mark the edge where the motor meets the base (the edge farthest away from the pump).
3. Remove the belt guard bolt and nut.
4. Remove the front belt guard cover.
5. Loosen the four motor mounting bolts.
6. The belt tension will pull the motor toward the pump. Remove the belt from the unit and set it on the ground.
7. Using the reference mark made in step 1, move the motor approximately 1/4" past the mark (moving it away from the pump).
8. Use a straight edge to make sure the motor pulley is in line with the pump flywheel. Tighten down the two motor bolts furthest from the pump.
9. Put the belt on the motor pulley and carefully roll it over the pump flywheel. Do this by starting the other end of the belt over the top of the pump flywheel and turning the flywheel counterclockwise.

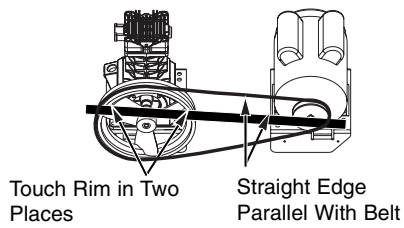

⚠CAUTION:

When installing belt, use caution to avoid injury to fingers or hands.

10. Check belt tension. If still too loose, loosen the front two motor bolts and repeat steps 4-6. (When doing so, move motor an additional 1/4" away from pump).
11. When belt tension is good, tighten the other two motor bolts.
12. Install the front belt guard cover.
13. Install and tighten the belt guard bolt and nut.

Storage

1. When not in use, compressor should be stored in a cool dry place.
2. Tanks should be drained of moisture.
3. Hose should be disconnected and hung open ends down to allow any moisture to drain.

Maintenance Schedule

Operation	Daily	Weekly
Drain Tanks	●	
Check Air Filter		●
Check Safety Valve		●
Blow Dirt From Inside Motor		●

Troubleshooting

⚠WARNING:

For your own safety do not try and run the air compressor while troubleshooting.

TROUBLE	PROBABLE CAUSE	REMEDY
Compressor will not run	<ol style="list-style-type: none"> 1. Unit is plugged into extension cord 2. No electrical power 3. Blown fuse 4. Breaker open 5. Thermal overload open 6. Pressure switch bad 	<ol style="list-style-type: none"> 1. Remove extension cord 2. Verify unit is plugged in. Check fuse/breaker or motor overload 3. Replace blown fuse 4. Reset, determining why problem happened 5. Motor will restart when cool 6. Replace
Motor hums but cannot run or runs slowly	<ol style="list-style-type: none"> 1. Low voltage 2. Unit is plugged into extension cord 3. Shorted or open motor winding 4. Defective check valve or unloader 	<ol style="list-style-type: none"> 1. Check with voltmeter 2. Remove extension cord 3. Replace motor 4. Replace or repair
Fuses blow/circuit breaker trips repeatedly	<ol style="list-style-type: none"> 1. Incorrect size fuse, circuit overloaded 2. Unit is plugged into extension cord 3. Defective check valve or unloader 	<ol style="list-style-type: none"> 1. Check for proper fuse, use time-delay fuse. Disconnect other electrical appliances from circuit or operate compressor on its own branch circuit 2. Remove extension cord 3. Replace or repair

TROUBLE	PROBABLE CAUSE	REMEDY
Thermal overload protector cuts out repeatedly	<ol style="list-style-type: none"> 1. Low voltage 2. Clogged air filter 3. Lack of proper ventilation/room temperature too high 4. Unit is plugged into extension cord 	<ol style="list-style-type: none"> 1. Check with voltmeter 2. Clean filter (see Maintenance section) 3. Move compressor to well ventilated area 4. Remove extension cord
Air tank pressure drops when compressor shuts off	<ol style="list-style-type: none"> 1. Loose connections (fittings, tubing, etc.) 2. Tank drain valve open 3. Check valve leaking 	<ol style="list-style-type: none"> 1. Check all connections with soap and water solution and tighten 2. Close valve 3. Disassemble check valve assembly, clean or replace <p>⚠ DANGER: Do not disassemble check valve with air in tank; bleed tank</p>
Excessive moisture in discharge air	<ol style="list-style-type: none"> 1. Excessive water in air tanks 2. High humidity 	<ol style="list-style-type: none"> 1. Drain tanks 2. Move to area of less humidity; use air line filter
Compressor runs continuously	<ol style="list-style-type: none"> 1. Defective pressure switch 2. Excessive air usage 	<ol style="list-style-type: none"> 1. Replace switch 2. Decrease air usage; compressor not large enough for a requirement
Compressor vibrates	Loose mounting bolts	Tighten
Air output lower than normal	<ol style="list-style-type: none"> 1. Broken inlet valves 2. Intake filter dirty 3. Connections leaking 	<ol style="list-style-type: none"> 1. Have authorized service representative repair unit 2. Clean or replace intake filter 3. Tighten connections

Troubleshooting (continued)

TROUBLE	PROBABLE CAUSE	REMEDY
Low discharge pressure	<ol style="list-style-type: none"> 1. Air leaks 2. Leaking valves 3. Restricted air intake 4. Slipping belts 5. Blown gaskets 6. Low compression 	<ol style="list-style-type: none"> 1. Listen for escaping air. Apply soap solution to all fittings and connections. Bubbles will appear at points of leakage. Tighten or replace leaking fittings or connections 2. Remove head and inspect for valve breakage, weak valves, scored valve seats, etc. Replace defective parts and reassemble <p>⚠CAUTION: Be sure that the old head gasket is replaced with a new one each time the head is removed</p> <ol style="list-style-type: none"> 3. Clean the air filter element 4. Adjust tension (See Drive Belt Section) 5. Replace any gaskets proven faulty on inspection 6. Low pressure can be due to worn rings and cylinder walls. Correction is made by replacing the rings, cylinders, and pistons as required

TROUBLE	PROBABLE CAUSE	REMEDY
Excessive belt wear	<ol style="list-style-type: none"> 1. Pulley out of alignment 2. Belt too loose or too tight 3. Belt slipping 4. Pulley wobbles 	<ol style="list-style-type: none"> 1. Realign motor pulley with compressor pulley 2. Adjust tension (See Drive Belt Section) 3. Adjust tension or replace belt (See Drive Belt Section) 4. Check for worn crankshaft, keyway or pulley bore resulting from running the compressor or motor with loose pulleys. Check for bent pulleys or bent crankshaft
Oil in the discharge air	<ol style="list-style-type: none"> 1. Worn piston rings 2. Compressor air intake restricted 3. Restricted breather 4. Excessive oil in compressor 5. Wrong oil viscosity 6. Connecting rod out of alignment 	<ol style="list-style-type: none"> 1. Replace with new rings 2. Clean filter. Check for other restrictions in the intake system 3. Clean and check breather for free operation 4. Drain down to full level 5. Use SAE 30 (ISO 100) non-detergent compressor oil, Mobil 1 5W30 or Mobil 1 10W30 (See page 14). 6. Replace rod

Repair Parts

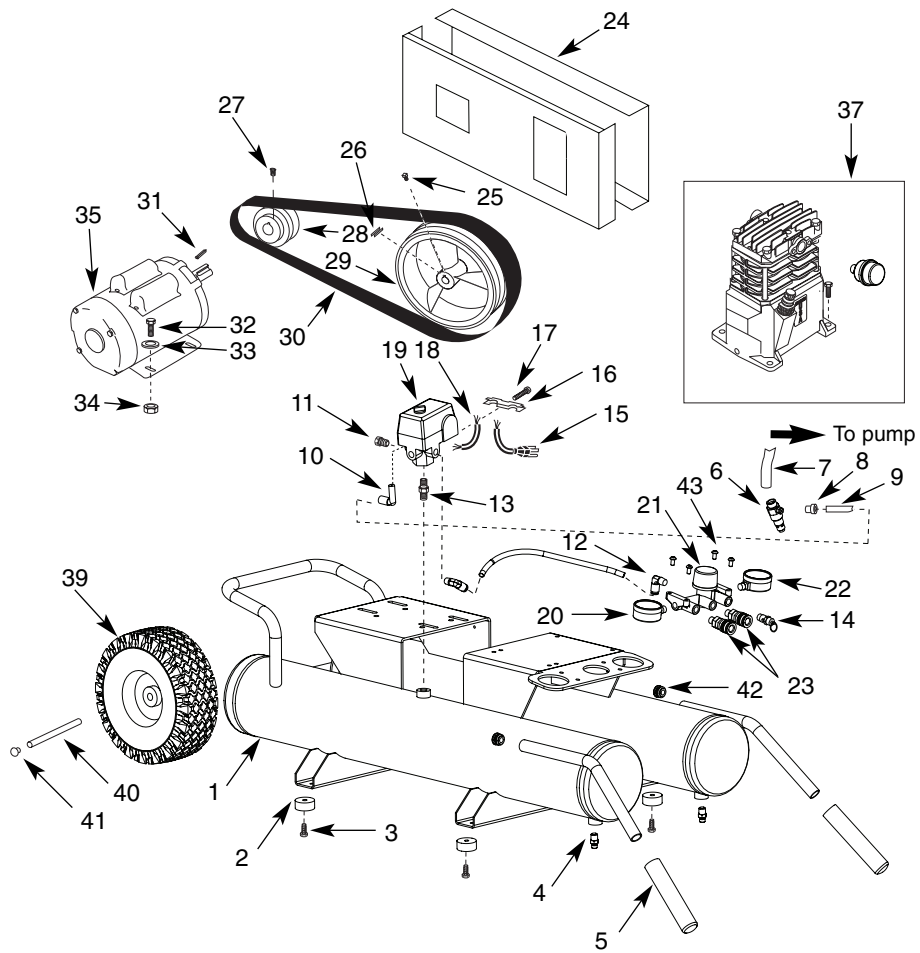

Repair Parts

For Repair Parts, Call 1-800-4-RIDGID

Please provide following information:

- Model number
- Serial number (if any)
- Part description and number as shown in parts list

Ref. No.	Catalog Number	Part Number	Description	Qty
1	20353	AR054700CG	Tank	1
2	17853	ST158300AV	Rubber Foot	4
3	18038	ST116400AV	Screw	4
4	20358	ST085800AV	Drain Valve	2
5	20363	ST160000AV	Handle Grip	2
6	20368	CV221515AV	Check Valve	1
7	20373	ST186601AV	Exhaust Tube	1
8	20378	ST081301AV	Push-In Fitting	1
9	20383	ST117802AV	Unloader Tube	1
10	17883	CW210000AV	Unloader	1
11	17888	ST022500AV	1/4" Plug	2
12	17868	ST119704AV	Elbow	2
13	17898	HF002401AV	Nipple	1
14	17798	V-215106AV	Safety Valve	1
15	20388	EC012602AV	Power Cord	1
16	20393	CW209500AV	Strain Relief	1
17	17753	ST209800AV	Strain Relief Screw	1
18	20398	EC012800AV	Motor Cord	1
19	17908	CW211300AJ	Pressure Switch	1
20	17878	GA016900AV	Outlet Gauge	1
21	17793	WL024501AV	Regulator	1
22	17773	GA016901AV	Tank Gauge	1
23	17873	HF203300AV	Coupler	2
24	20403	BG220200AJ	Belt Guard Assembly	1
25	17998	ST026200AV	3/8" Set Screw	1
26	18088	KE000900AV	3/16" Key	1
27	18093	ST012200AV	1/4" Set Screw	1
28	20408	PU015200AV	Pulley	1
29	18078	PU015900AV	Flywheel	1
30	20413	BT020400AV	Belt	1
31	20418	KE000903AV	Key	1
32	20423	ST016000AV	Motor Bolt	4
33	18113	ST011200AV	5/16" Washer	4
34	20428	ST146001AV	5/16" Nut	4
35	20433	MC018300IP	Electric Motor	1
36	20438	ST073249AV	Tapping Screw	4
37	20443	VT480000KB	Pump	1
38	20448	ST085700AV	Filter	1
39	18053	WA005501AV	Wheel	1
40	18043	AA021800AV	Axle Rod	1
41	18048	ST073613AV	Plug	2
42	20453	ST073611AV	Plug	2
43	20458	ST071626AV	Screw, Torx 1/4 - 20 x 1/2"	4

Repair Parts

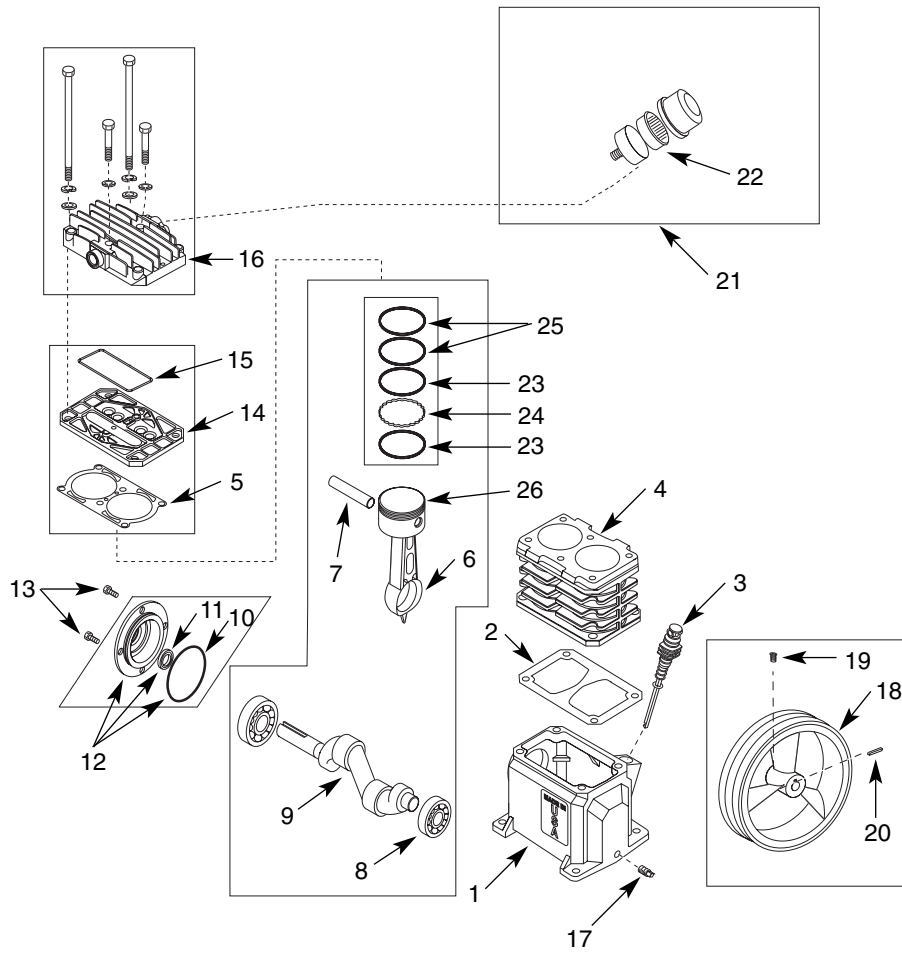

Repair Parts

For Repair Parts, Call 1-800-4-RIDGID

Please provide following information:

- Model number
- Serial number (if any)
- Part description and number as shown in parts list

Ref. No.	Catalog Number	Part Number	Description	Qty
1	18143	VT040300AG	Crankcase	1
2	—	●	Crankcase gasket	1
3	18133	VT041700AJ	Dipstick breather	1
4	18128	VT040750AG	Cylinder	1
5	—	●	Cylinder gasket	1
6	18158	VT040100AG	Connecting rod	2
7	18163	VS001400AV	Piston pin	2
8	18148	ST084202AV	Ball bearing	2
9	18153	VT040600AJ	Crankshaft Assembly	1
10	—	●	O-ring	1
11	18178	ST129700AV, ●	Oil seal	1
12	18173	VT040200AJ	Bearing cap assembly	1
13	18183	ST076840AV	M6-1.00 x 10 cap screw	4
14	18188	VT470800AJ	Valve plate assembly	1
15	—	●	Valve plate gasket	1
16	18193	TQ900800AJ	Cylinder head & fasteners	1
17	18138	ST022300AV	1/8" NPT oil drain plug	1
18	18078	PU015900AV	Flywheel	1
19	17998	ST026200AV	3/8-16 x 3/4" Setscrew	1
20	18088	KE000900AV	3/16" key	1
21	20448	ST085700AV	Air filter	1
22	20488	ST085701AV	Filter element	1
23	—	■	Oil ring	4
24	—	■	Expander	2
25	—	■	Ring	4
26	18168	TQ011900AG, ▲	Piston	2
REPAIR KITS				
●	18198	VT470900AJ	Gasket kit	1
■	18203	VT210400AJ	Piston ring set	1
▲	18208	VT005501AJ	Piston service kit	2



Catalog No. OL90150
Model No. OL90150
Serial No. _____
The model and serial numbers may be found on your unit. You should record both model and serial number in a safe place for future use.

RIDGID AIR COMPRESSOR LIMITED THREE YEAR WARRANTY

This product is manufactured by Campbell Hausfeld. The trademark is licensed from RIDGID, Inc. All warranty communications should be directed to RIDGID air compressor technical service at (toll free) 1-800-4-RIDGID.

WHAT IS COVERED UNDER THE LIMITED THREE YEAR WARRANTY

This warranty covers all defects in workmanship or materials in this RIDGID air compressor for the three-year period from the date of purchase. This warranty is specific to this air compressor. Warranties for other RIDGID products may vary.

HOW TO OBTAIN SERVICE

To obtain service for this RIDGID air compressor you must return it, freight prepaid, to a service center authorized to repair RIDGID air compressors. You may obtain the location of the service center nearest you by calling (toll free) 1-800-4-RIDGID or by logging on to the RIDGID website at www.ridgid.com. When requesting warranty service, you must present the proof of purchase documentation, which includes a date of purchase. The authorized service center will repair any faulty workmanship, and either repair or replace any defective part, at Campbell Hausfeld's option at no charge to you.

WHAT IS NOT COVERED

This warranty applies only to the original purchaser at retail and may not be transferred. This warranty does not cover normal wear and tear or any malfunction, failure or defect resulting from misuse, abuse, neglect, alteration, modification or repair by other than a service center authorized to repair RIDGID branded air compressors. Expendable materials, such as oil, filters, etc. are not covered by this warranty. Gasoline engines and components are expressly excluded from coverage and you must comply with the warranty given by the engine manufacturer, which is supplied with the product. **CAMPBELL HAUSFELD MAKES NO WARRANTIES, REPRESENTATIONS OR PROMISES AS TO THE QUALITY OR PERFORMANCE OF ITS AIR COMPRESSORS OTHER THAN THOSE SPECIFICALLY STATED IN THIS WARRANTY. RIDGID, INC. MAKES NO WARRANTIES OR REPRESENTATIONS, EXPRESS OR IMPLIED, INCLUDING AS NOTED BELOW.**

ADDITIONAL LIMITATIONS

To the extent permitted by applicable law, all implied warranties, including warranties of MERCHANTABILITY or FITNESS FOR A PARTICULAR PURPOSE, are disclaimed. Any implied warranties, including warranties of merchantability or fitness for a particular purpose, that cannot be disclaimed under state law are limited to three years from the date of purchase. Campbell Hausfeld is not responsible for direct, indirect, incidental, special or consequential damages. Some states do not allow limitations on how long an implied warranty lasts and/or do not allow the exclusion or limitation of incidental or consequential damages, so the above limitations may not apply to you. This warranty gives you specific legal rights, and you may also have other rights, which vary from state to state.

QUESTIONS OR COMMENTS

CALL 1-800-4-RIDGID

www.ridgid.com

Please have your Model Number and Serial Number on hand when calling.