

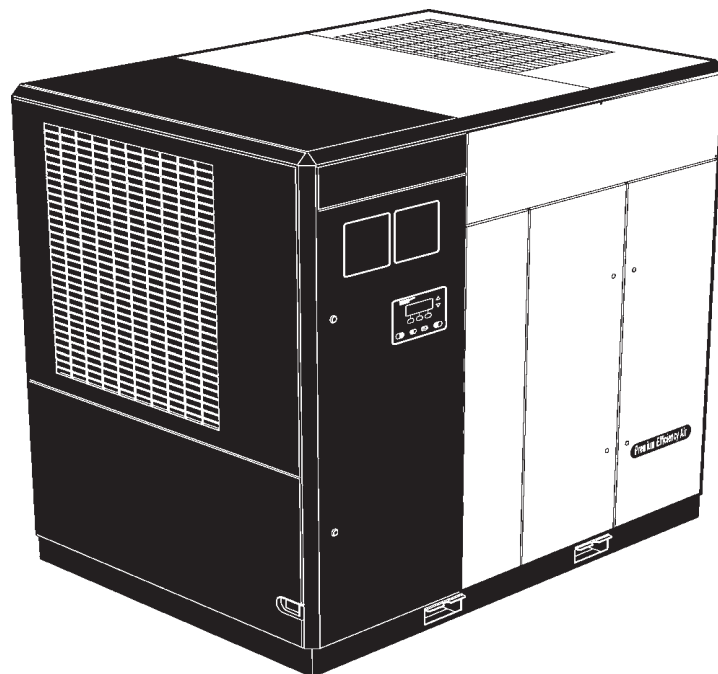

IRN37-160K-CC
IRN50-200H-CC
IRN75-160K-2S
IRN100-200H-2S
IRN250-300H-2S

OPERATION AND MAINTENANCE MANUAL



Ensure that the operator reads and understands the decals and consults the manuals before maintenance or operation.

Ensure that the Operation and Maintenance manual is not removed permanently from the machine.

Ensure that maintenance personnel are adequately trained, competent and have read the Maintenance Manuals.



C.C.N. : 54731245
DATE : DECEMBER 2007
REV. : J

AIR COMPRESSOR GROUP BONDED WARRANTY & REGISTERED START UP

WARRANTY

The Company warrants that the equipment manufactured by it and delivered hereunder will be free of defects in material and workmanship for a period of twelve months from the date of placing the Equipment in operation or eighteen months from the date of shipment from the factory, whichever shall first occur. The Purchaser shall be obligated to promptly report any failure to conform to this warranty, in writing to the Company in said period, whereupon the Company shall, at its option, correct such nonconformity, by suitable repair to such equipment or, furnish a replacement part F.O.B. point of shipment, provided the Purchaser has stored, installed, maintained and operated such Equipment in accordance with good industry practices and has complied with specific recommendations of the Company. Accessories or equipment furnished by the Company, but manufactured by others, shall carry whatever warranty the manufacturers have conveyed to the Company and which can be passed on to the Purchaser. The Company shall not be liable for any repairs, replacements, or adjustments to the Equipment or any costs of labor performed by the Purchaser or others without Company's prior written approval.

The effects of corrosion, erosion and normal wear and tear are specifically excluded. Performance warranties are limited to those specifically stated within the Company's proposal. Unless responsibility for meeting such performance warranties are limited to specified tests, the Company's obligation shall be to correct in the manner and for the period of time provided above.

THE COMPANY MAKES NO OTHER WARRANTY OR REPRESENTATION OF ANY KIND WHATSOEVER, EXPRESSED OR IMPLIED, EXCEPT THAT OF TITLE, AND ALL IMPLIED WARRANTIES OF MERCHANTABILITY AND FITNESS FOR A PARTICULAR PURPOSE, ARE HEREBY DISCLAIMED.

Correction by the Company of nonconformities whether patent or latent, in the manner and for the period of time provided above, shall constitute fulfillment of all liabilities of the Company for such non conformities whether based on contract, warranty negligence, indemnity, strict liability or otherwise with respect to or arising out of such Equipment.

The purchaser shall not operate Equipment which is considered to be defective, without first notifying the Company in writing of its intention to do so. Any such use of Equipment will be at Purchaser's sole risk and liability.

Note that this is Ingersoll Rand standard warranty. Any warranty in force at the time of purchase of the compressor or negotiated as part of the purchase order may take precedence over this warranty.

1.0 CONTENTS

CONTENTS	PAGE	CONTENTS	PAGE
1.0 CONTENTS	1	9.6 OPERATOR SETPOINTS	71
2.0 FOREWORD	2	9.7 OPTIONS	73
3.0 ABBREVIATIONS & SYMBOLS	4	9.8 SENSOR CALIBRATION	74
4.0 PURCHASE ORDER DETAILS	5	9.9 ALARM HISTORY	75
5.0 SAFETY	6	9.10 CLOCK FUNCTIONS	75
5.1 SAFETY INSTRUCTIONS	6	9.11 ENERGY STATUS MESSAGES	76
5.2 SAFETY PRECAUTIONS	6	9.12 WARNINGS	77
5.3 TEXT DECALS	9	9.13 SERVICE WARNINGS	77
5.4 GRAPHIC FORM AND MEANING OF ISO SYMBOLS	13	9.14 INITIAL CHECK ALARMS:	77
6.0 RECEIPT / HANDLING	18	9.15 ALARMS	78
6.1 RECEIPT	18	10.0 MAINTENANCE	79
6.2 UNPACKING AND HANDLING	18	10.1 MAINTENANCE PROMPTS	79
7.0 INSTALLATION	19	10.2 MAINTENANCE CHART	80
7.1 LOCATION IN PLANT	19	10.3 MAINTENANCE PROCEDURES	81
7.2 DISCHARGE AND CONDENSATE PIPING 20		10.4 ROUTINE MAINTENANCE	83
7.3 ELECTRICAL	21	11.0 FAULT FINDING	91
7.4 WATERCOOLED UNITS	23		
7.5 SEA WATERCOOLED UNITS (SELECTED UNITS ONLY)	25		
7.6 OUTDOOR SHELTERED INSTALLATION	26		
8.0 GENERAL INFORMATION	27		
8.1 TECHNICAL INFORMATION	27		
8.2 INSTALLATION DRAWING	33		
8.3 PROCESS AND INSTRUMENTATION DIAGRAM	42		
8.4 ELECTRICAL SCHEMATIC	50		
8.5 GENERAL DESCRIPTION	64		
9.0 OPERATING INSTRUCTIONS	65		
9.1 BASIC OPERATION	65		
9.2 INTELLISYS CONTROLS	67		
9.3 DISPLAY SCREEN	68		
9.4 CURRENT STATUS SCREEN	69		
9.5 MAIN MENU	70		

2.0 FOREWORD

Machine models represented in this manual may be used in various locations worldwide. Machines sold and shipped into European community countries require that the machine display the EC Mark and conform to various directives. In such cases, the design specification of this machine has been certified as complying with EC directives. Any modification to any part is absolutely prohibited and would result in the CE certification and marking being rendered invalid.

The contents of this manual are considered to be proprietary and confidential to Ingersoll Rand and should not be reproduced without the prior written permission of Ingersoll Rand.

Nothing contained in this document is intended to extend any promise, warranty or representation, expressed or implied, regarding the Ingersoll Rand products described herein. Any such warranties or other terms and conditions of sale of products shall be in accordance with the standard terms and conditions of sale for such products, which are available upon request.

This manual contains instructions and technical data to cover all routine operation and scheduled maintenance tasks by operation and maintenance staff.

Major overhauls are outside the scope of this manual and should be referred to an authorized Ingersoll Rand service department.

All components, accessories, pipes and connectors added to the compressed air system should be:

- of good quality, procured from a reputable manufacturer and, wherever possible, be of a type approved by Ingersoll Rand.
- clearly rated for a pressure at least equal to the machine maximum allowable working pressure.
- compatible with the compressor lubricant/coolant.
- accompanied with instructions for safe installation, operation and maintenance.

Ingersoll Rand reserves the right to make changes and improvements to products without notice and without incurring any obligation to make such changes or add such improvements to products sold previously.

Details of approved equipment are available from Ingersoll Rand Service departments.

This machine has been designed and supplied for use only in the following specified conditions and applications:

- Compression of normal ambient air containing no known or detectable additional gases, vapors or particles
- Operation within the ambient temperature range specified in the *GENERAL INFORMATION* section of this manual.

IF IN DOUBT CONSULT SUPERVISION.

The company accepts no responsibility for errors in translation of this manual from the original English version.

The design of this Compressor package and certain features within it are covered by patents held by Ingersoll Rand and patents pending

SSR ULTRA COOLANT is a registered trademark of Ingersoll Rand Company USA.

INTELLISYS is a registered trademark of Ingersoll Rand Company USA.

HPM™, HYBRID PERMANENT MAGNET™ and HPM Logo are trade marks registered by MOTEURS LE-ROY-SOMER

© COPYRIGHT 2007

INGERSOLL RAND COMPANY

2.0 FOREWORD

⚠ WARNING

The use of the machine in any of the situation types listed in table 1:–

- a) Is not approved by Ingersoll Rand,
- b) May impair the safety of users and other persons, and
- c) May prejudice any claims made against Ingersoll Rand.

TABLE 1

⚠ WARNING – NOT PERMITTED

Use of the machine to produce compressed air for:

- a) direct human consumption
- b) indirect human consumption.

Use of the machine outside the ambient temperature range specified in the *GENERAL INFORMATION SECTION* of this manual.

Use of the machine where there is any actual or foreseeable risk of hazardous levels of flammable gases or vapors.

THIS MACHINE IS NOT INTENDED AND MUST NOT BE USED IN POTENTIALLY EXPLOSIVE ATMOSPHERES, INCLUDING SITUATIONS WHERE FLAMMABLE GASES OR VAPOURS MAY BE PRESENT.

Use of the machine fitted with non Ingersoll Rand approved components.

Use of the machine with safety or control components missing or disabled.

Connection to an electrical supply of incorrect voltage and/or frequency.

⚠ WARNING

The use of repair parts other than those included within the Ingersoll Rand approved parts list may create hazardous conditions over which Ingersoll Rand has no control. Therefore Ingersoll Rand cannot be held responsible for equipment in which non–approved repair parts are installed.

⚠ WARNING

The motor rotor contains a powerful magnetic field. This field can effect the operation of digital devices such as watches, mobile phones etc. Assembly or handling of the rotor should not be attempted by personnel with cardiac pacemakers, defibrillators or other implanted electronic medical device.

⚠ WARNING

This compressor contains a variable frequency drive. When it is switched off and the motor is stopped, the internal capacitors store a potentially lethal high voltage. **DO NOT REMOVE THE DRIVE COVER** or attempt any work on the drive unless trained. There are no user serviceable items behind the cover.

⚠ WARNING

The compressor can operate in a pressurised shutdown mode. If the compressor stops automatically, the airend, separator tank and oil system can contain high pressure air. This can be relieved by pressing the emergency stop button and can be verified by unscrewing the coolant fill plug which has a vent hole through which any residual pressure will be vented. Downstream of the separator tank may still contain system pressure which must also be vented.

NOTICE

The manual is intended for worldwide use and contains both metric and imperial data where required.

3.0 ABBREVIATIONS & SYMBOLS

####	Contact Ingersoll Rand for serial number
->####	Up to Serial No.
####->	From Serial No.
*	Not illustrated
†	Option
NR	Not required
AR	As required
SM	Sitemaster/Sitepack
HA	High ambient machine
WC	Watercooled machine
AC	Aircooled machine
ERS	Energy recovery system
T.E.F.C.	Totally enclosed fan cooled motor (IP54)
O.D.P.	Open drip proof (motor)
ppm	parts per million

cs	Czech
da	Danish
de	German
el	Greek
en	English
es	Spanish
et	Estonian
fi	Finnish
fr	French
hu	Hungarian
it	Italian
lt	Lithuanian
lv	Latvian, Lettish
mt	Maltese
nl	Dutch
no	Norwegian
pl	Polish
pt	Portuguese
sk	Slovak
sl	Slovenian
sv	Swedish
zh	Chinese

4.0 PURCHASE ORDER DETAILS

ROTARY SCREW AIR COMPRESSOR

This unit was purchased from

Ingersoll Rand Company reserves the right to make changes or add improvements without notice and without incurring any obligation to make such changes or add such improvements to products sold previously.

No. of units on order: _____

Customer Order No: _____

Ingersoll Rand Co. Order No _____

For ready reference:

Record the serial number and model number of your unit here.

Serial Number: _____

Model Number: _____

5.0 SAFETY

5.1 SAFETY INSTRUCTIONS

Safety instructions in the operators manual are bold-faced for emphasis. The signal words DANGER, WARNING and CAUTION are used to indicate hazard seriousness levels as follows.

Ensure that the operator reads and understands the decals and consults the manuals before maintenance or operation.

DANGER

Indicates the presence of a hazard which **WILL** cause serious injury, death or property damage, if ignored.

WARNING

Indicates the presence of a hazard which **CAN** cause serious injury, death or property damage, if ignored.

Ensure that the Operation and Maintenance manual, and the manual holder, are not permanently removed from the machine.

Ensure that maintenance personnel are adequately trained, competent and have read the Maintenance Manuals.

CAUTION

Indicates the presence of a hazard which **WILL** or **can** cause injury or property damage, if ignored.

NOTICE

Indicates important set-up, operating or maintenance information.

5.2 SAFETY PRECAUTIONS

General Information

Compressed air and electricity can be dangerous. Before undertaking any work on the compressor, ensure that the electrical supply has been isolated, locked off, tagged and the compressor has been relieved of all pressure.

Make sure that all protective covers are in place and that the canopy/doors are closed during operation.

Installation of this compressor must be in accordance with recognized electrical codes and any local Health and Safety Codes.

Use only safety solvent for cleaning the compressor and auxiliary equipment.

Compressed air

Ensure that the machine is operating at the rated pressure and that the rated pressure is known to all relevant personnel.

All air pressure equipment installed in or connected to the machine must have safe working pressure ratings of at least the machine rated pressure.

If more than one compressor is connected to one common downstream plant, effective check valves and isolation valves must be fitted and controlled by work procedures, so that one machine cannot accidentally be pressurized / over pressurized by another.

If a safety valve is installed between the isolation valve and the compressor, it must have sufficient capacity to relieve the full capacity of the compressor(s).

The discharged air contains a very small percentage of compressor lubricating oil and care should be taken to ensure that downstream equipment is compatible.

If the discharged air is to be ultimately released into a confined space, adequate ventilation must be provided.

The use of plastic bowls on line filters without metal guards can be hazardous. Their safety can be affected by either synthetic lubricants, or the additives used in mineral oils. Metal bowls should be used on a pressurized system.

5.0 SAFETY

When using compressed air always use appropriate personal protective equipment.

All pressure containing parts, especially flexible hoses and their couplings, must be regularly inspected, be free from defects and be replaced according to the Manual instructions.

Compressed air can be dangerous if incorrectly handled. Before doing any work on the unit, ensure that all pressure is vented from the system and that the machine cannot be started accidentally.

Avoid bodily contact with compressed air.

The safety valve located in the separator tank must be checked periodically for correct operation.

Whenever pressure is released through the pressure relief valve, it is due to excessive pressure in the system. The cause for the excessive pressure should be investigated immediately.

Materials

The following substances are used in the manufacture of this machine and may be hazardous to health if used incorrectly:

- preservative grease
- rust preventative
- compressor coolant

WARNING

AVOID INGESTION, SKIN CONTACT AND INHALATION OF FUMES

For further information, request and consult the coolant Material Data Sheet (UK ACGP 011/96 –ULTRA COOLANT ACGP 029/90–food grade coolant. For USA served areas, use MSDS sheet APDD 236) from your local IR office, Distributor or Air Center.

Should compressor lubricant come into contact with the eyes, then irrigate with water for at least 5 minutes.

Should compressor lubricant come into contact with the skin, then wash off immediately.

Consult a physician if large amounts of compressor lubricant are ingested.

Consult a physician if compressor lubricant is inhaled.

Never give fluids or induce vomiting if the patient is unconscious or having convulsions.

The above information contains data supplied in support of United Kingdom *Control of Substances Hazardous to Health* (C.O.S.H.H.) regulations

Transport

When loading or transporting machines ensure that the specified lifting and tie down points are used.

It is recommended that the machine be moved using the fork lift slots in the machine base.

Refer to section 8-General Information for reference information.

Electrical

The compressor has high and dangerous voltage in the motor starter and control box. All installations must be in accordance with recognized electrical codes. Before working on the electrical system, be sure to remove voltage from the system by using a manual disconnect switch. A circuit breaker or fuse safety switch must be provided in the electrical supply line leading to the compressor.

Those responsible for installation of this equipment must provide suitable grounds, maintenance clearance and lightning arrestors for all electrical components in accordance with National and Local code requirements.

Keep all parts of the body and any hand-held tools or other conductive objects, away from exposed live parts of the compressor electrical system. Maintain dry footing, stand on insulating surfaces and do not contact any other portion of the compressor when making adjustments or repairs to exposed live parts of the compressor electrical system.

Close and lock all access doors when the compressor is left unattended.

Do not use extinguishers intended for Class A or Class B fires on electrical fires. Use only extinguishers suitable for class BC or class ABC fires.

Attempt repairs only in clean, dry, well lighted and ventilated areas.

Connect the compressor only to electrical systems that are compatible with its electrical characteristics and that are within its rated capacity.

5.0 SAFETY

Condensate disposal

Condensate cannot be discharged into fresh/surface water drains. In some regions compressor condensate containing ULTRA COOLANT can be fed directly into a drainage system that has downstream sewage treatment.

As waste water regulations vary by country and region it is the responsibility of the user to establish the limitations and regulations in their particular area. Ingersoll Rand and its associated distributors are happy to advise and assist in these matters.

Coolant disposal

Steps to be taken in the case of spillage: Soak up with a suitable absorbent material, then sweep into a plastic bag for disposal.

Burn in an approved incinerator, or according to local area or country regulations.

For further information, consult ULTRA COOLANT Material Data Sheets ACGP 011/96 or APDD 236. FOOD GRADE COOLANT Material Data Sheets IRACA145 or APDD190.

⚠ WARNING

This compressor contains a variable frequency drive. When it is switched off and the motor is stopped, the internal capacitors store a potentially lethal high voltage. DO NOT REMOVE THE DRIVE COVER or attempt any work on the drive unless trained. There are no user serviceable items behind the cover.

⚠ WARNING

There is a high discharge air temperature shutdown function built into each compressor. It is factory preset at 109 °C (228° F). This function should be checked at regular intervals for proper operation, once a month is recommended. Refer to maintenance section.

Failure to adhere to these recommendations can result in mechanical failure, property damage and serious injury or death.

- **All air and water inlet, and air and water discharge pipework to and from the inlet and discharge port connections must take into account vibration, pulsations, temperature, maximum pressure applied, corrosion and chemical resistance. In addition, it should be noted that lubricated compressors will discharge some oil into the air stream; therefore, compatibility between discharge piping, system accessories and software must be assured.**
- **For the foregoing reasons, the use of plastic piping and rubber hose as discharge piping is not recommended. In addition, flexible joints and/or flex lines can only be considered for such purposes if their specifications fit the operating parameters of the system.**
- **It is the responsibility of the installer and owner to provide the appropriate service pipework to and from the machine.**

⚠ WARNING

"Ingersoll Rand air compressors are not designed, intended, or approved for breathing air applications. Ingersoll Rand does not approve specialized equipment for breathing air application and assumes no responsibility or liability for compressors used for breathing air services."

⚠ WARNING

No portable communication devices emitting more than 7.5 volts per metre in the frequency range from 250 MHz to 280 MHz should be operated within 5m (16.5ft) of the unit.

⚠ WARNING

The motor rotor contains a powerful magnetic field. This field can effect the operation of digital devices such as watches, mobile phones etc. Assembly or handling of the rotor should not be attempted by personnel with cardiac pacemakers, defibrillators or other implanted electronic medical device.

⚠ WARNING

The specification of this machine is such that the machine is not suitable for use in flammable gas risk areas. If such an application is required then all local regulations, codes of practice and site rules must be observed. To ensure that the machine can operate in a safe and reliable manner, additional equipment such as gas detection and intake (shut-off) valves may be required, dependant on local regulations or the degree of risk involved.

⚠ WARNING

The compressor can operate in a pressurized shutdown mode. If the compressor stops automatically, the airend, separator tank and oil system can contain high pressure air. This can be relieved by pressing the emergency stop button and can be verified by unscrewing the coolant fill plug which has a vent hole through which any residual pressure will be vented. Downstream of the separator tank may still contain system pressure which must also be vented

5.0 SAFETY

Depending on point of manufacture and point of use, the compressor and this manual will show symbols from the following sections. Compressors for use within the European Community must be equipped with symbols from section 5.4. Read and understand thoroughly. Heed warnings and follow instructions. If you do not understand, inform your supervisor.

5.3 TEXT DECALS

NOTICE

To obtain satisfactory compressor operation and maintenance, a minimum of 3 feet clearance on 3 sides is required. 3 1/2 feet is required in front of the control panel (or minimum required by latest National Electrical code or applicable local codes.)

Refer to the Instruction / Operators Manual before performing any maintenance.



DANGER

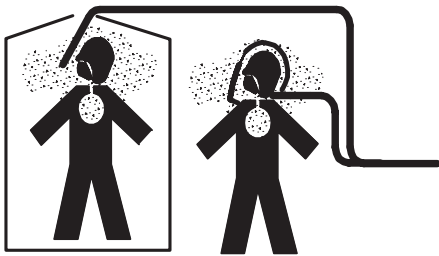

Discharge air.
Can contain carbon monoxide or other contaminants. Will cause severe injury or death.

Do not breathe this air.



WARNING



Hazardous voltage. Can cause severe injury or death.

Disconnect power before servicing.
Lockout/Tagout machine.



WARNING



Rotating fan blade. Can cause severe injury.

Do not operate with covers removed.
Disconnect power. Lock/out and tag out machine.



5.0 SAFETY



CAUTION

Incorrect lifting of machine can cause injury or property damage.

Lift only from base channels



WARNING



High pressure air.
Can cause severe injury or death.

Compressor can operate in a pressurized shutdown mode.

Relieve pressure before removing filter plugs/caps, fittings or covers.



22061915 Rev. A

NOTICE

Air discharge



CAUTION

Use of incorrect coolant can cause system contamination.

Use only SSR ULTRA COOLANT



WARNING

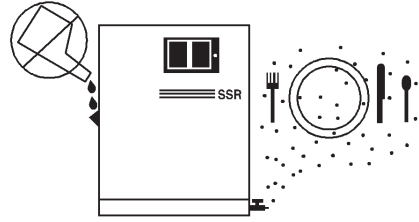

Food contaminant.
Can cause severe injury or death.

Use only Ingersoll Rand SSR H-1F food grade coolant.



39568464 Rev. 03

NOTICE

Lift here



WARNING



Hot surface.
Can cause severe injury.

Do not touch. Allow to cool before servicing.



5.0 SAFETY



CAUTION

Improper coolant filter replacement will cause compressor damage.

Replace filter element after first 150 hours of operation and every 2000 hours thereafter or when coolant is changed.



NOTICE



Rotation

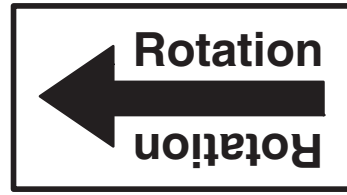

730Vdc



15 mins.



WARNING

Variable frequency drive to be serviced by trained personnel only. After switching off the machine at its local isolator, WAIT AT LEAST 15 MINUTES for the capacitors to fully discharge before removing the drive cover. With caution, verify DC bus voltage is zero before servicing. Proceed with caution.

ADVERTÊNCIA

O módulo conversor de frequência somente deve ser mantido por um técnico capacitado. Depois de desligar o equipamento no seu disjuntor local, ESPERE PELO MENOS 15 MINUTOS para que se descarreguem completamente os capacitores antes da remoção das portas de proteção do módulo. Antes da manutenção, verifique com cautela se a tensão DC bus está em zero. Prosiga com prudência.

ADVERTENCIA

El módulo conversor de frecuencia deberá ser mantenido por un técnico capacitado. Después de desconectar el equipo en su aislador local, ESPERE 15 MINUTOS COMO MÍNIMO para que se descarguen por completo los condensadores antes de quitar la cubierta protectora del módulo. Antes de proveer mantenimiento, verifique con precaución se el voltage DC Bus está en zero. Prosiga con prudencia.

22066302 Rev. D



WARNING HIGH VOLTAGE

Do not attempt any work.
Read manual.
Trained service personnel only.
Remove electrical supply.
Wait 15 minutes.
Check for zero voltage.
Proceed with caution.



WARNING



Moving parts. Can cause severe injury.

Do not operate with covers removed.
Service only with machine blocked to prevent turn over.



39540224 Rev. 04

Air Discharge



39540257 Rev. 04

5.0 SAFETY

Condensate drain.



Electrical power inlet.



WARNING



Hazardous voltage. Can cause severe injury or death.

Disconnect power before servicing.
Lockout/Tagout machine.



NOTICE

To obtain satisfactory compressor operation and maintenance, a minimum of 3 feet clearance on 3 sides is required. 3 1/2 feet is required in front of the control panel (or minimum required by latest National Electrical code or applicable local codes.)

Refer to the Instruction / Operators Manual before performing any maintenance.



Use 75°C copper wire only.
Nur 75°C kupferdraht verwenden.
Utilisez 75°C uniquement fil de cuivre.
Usar solamente cable de cobre para 75°C.
usare 75°C solamente cavi di rame.
Use somente fio de cobre de 75°.



39492384 Rev. 03

Use 75°C copper wire only.



IMPORTANT

Before starting this air compressor unit the shipping brace(s) must be removed. Save the brace(s) for future use. Refer to Operators/Instruction Manual.













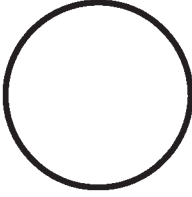
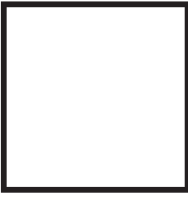

39481130 Rev. 02

IMPORTANT











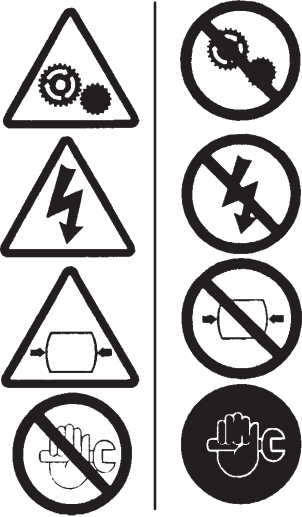

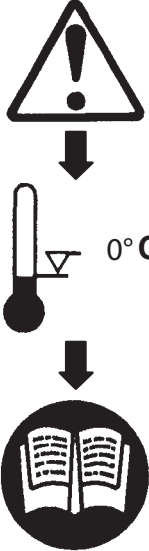
Before starting this air compressor unit the shipping brace(s) must be removed. Save the brace(s) for future use. Refer to Operators / Instruction Manual.

5.0 SAFETY













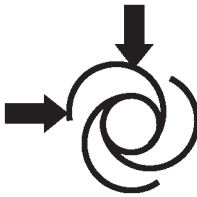
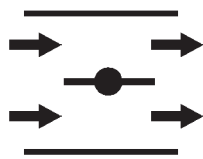

5.4 GRAPHIC FORM AND MEANING OF ISO SYMBOLS

		
Prohibition / Mandatory	Information / Instructions	Warning
 <p style="text-align: center; margin-top: 5px;">WARNING: Electrical shock risk.</p>	 <p style="text-align: center; margin-top: 5px;">WARNING – Pressurized component or system.</p>	 <p style="text-align: center; margin-top: 5px;">WARNING – Hot surface.</p>
 <p style="text-align: center; margin-top: 5px;">WARNING – Pressure control.</p>	 <p style="text-align: center; margin-top: 5px;">WARNING – Corrosion risk.</p>	 <p style="text-align: center; margin-top: 5px;">WARNING – Air/gas flow or Air discharge.</p>
 <p style="text-align: center; margin-top: 5px;">WARNING – Pressurized vessel.</p>	 <p style="text-align: center; margin-top: 5px;">Do not remove the Operating and Maintenance manual from this machine.</p>	 <p style="text-align: center; margin-top: 5px;">WARNING – Flammable liquid.</p>
	 <p style="text-align: center; margin-top: 5px;">WARNING – Rotor magnetic field can affect pacemakers.</p>	

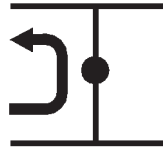
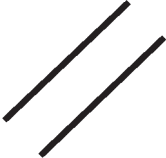
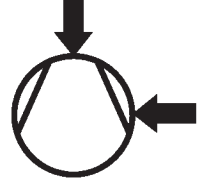
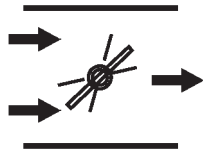



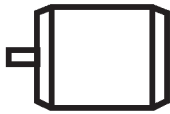







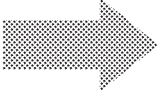
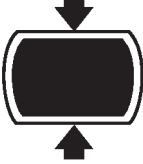



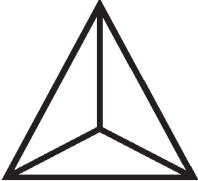
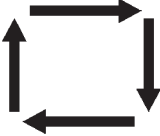

5.0 SAFETY

 <p>WARNING – Do not undertake any maintenance on this machine until the electrical supply is disconnected and the air pressure is totally relieved.</p>	 <p>WARNING – Consult the Operation and Maintenance manual before commencing any maintenance.</p>	 <p>WARNING – For operating temperature below 0°C, consult the Operation and Maintenance manual.</p>
 <p>Read the Operation and Maintenance manual before operation or maintenance of this machine is undertaken.</p>	 <p>Do not stack.</p>	 <p>Do not operate the machine without the guard being in place.</p>
 <p>Do not stand on any service valve or other parts of the pressure system.</p>	 <p>Do not operate with the doors or enclosure open.</p>	 <p>Do not use fork lift truck from this side.</p>
 <p>Do not breathe the compressed air from this machine.</p>	 <p>No naked lights.</p>	 <p>Do not open the service valve before the air hose is attached.</p>

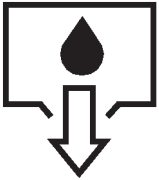

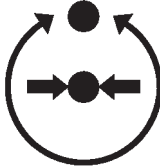







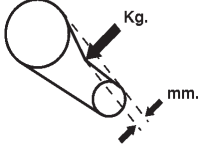
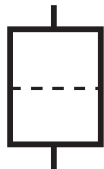

5.0 SAFETY

		
Use fork lift truck from this side only.	Emergency stop.	Tie down point
		
Lifting point.	On (power).	Off (power).
		
SET	SEQUENCER STATUS	LOAD
		
SEQUENCER (AUTOMATIC CONTROL)	COMPRESSOR	OFF LOAD (UNLOADED)
		
RESET	COMPRESSOR STATUS	MODULATE
		
MALFUNCTION	POWER	FOULED FILTER
		
POWER INLET	ELECTRIC MOTOR	HOURS

5.0 SAFETY

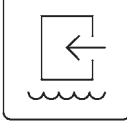
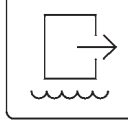
		
COOLANT SEPARATOR	PRESSURE	AIR DISCHARGE
		
PRESSURIZED TANK	ON / OFF CYCLE	COOLANT FILTER
		
AIR FILTER	ON / OFF PUSH BUTTON	COOLANT PRESSURE
		
AIR PRESSURE	STAR DELTA IEC 617-7	AUTOMATIC RESTART
		
HEAT EXCHANGER	MAINTENANCE	MAINTENANCE PROHIBITED
		
COOLANT DRAIN	CONDENSATE DRAIN	PRESSURE CONTROL
		
MANUAL (SELECT)	TEMPERATURE	HIGH TEMPERATURE

5.0 SAFETY

 <p style="text-align: center;">BELT TENSION</p>	 <p style="text-align: center;">FILTER</p>	 <p style="text-align: center;">MOTOR LUBRICATION</p>
 <p style="text-align: center;">FRAGILE</p>	 <p style="text-align: center;">KEEP DRY</p>	 <p style="text-align: center;">THIS WAY UP</p>
 <p style="text-align: center;">USE NO HOOKS</p>	 <p style="text-align: center;">NO SIDE CLAMPS</p>	 <p style="text-align: center;">ROTATION</p>
 <p style="text-align: center;">POWER INLET (AC)</p>	 <p style="text-align: center;">WATER IN</p>	 <p style="text-align: center;">WATER OUT</p>
 <p style="text-align: center;">TRAINED SERVICE PERSONNEL</p>	 <p style="text-align: center;">15 mins. WAIT TIME</p>	 <p style="text-align: center;">CHECK ZERO VOLTS</p>

6.0 RECEIPT / HANDLING

6.1 RECEIPT

When you receive the compressor please inspect it closely. Any indication of careless handling by the carrier should be noted on the delivery receipt especially if the compressor will not be immediately unpacked. Obtaining the delivery persons signed agreement to any noted damages will facilitate any future insurance claims.

IMPORTANT READ THIS LOST OR DAMAGED GOODS

THOROUGHLY INSPECT THIS SHIPMENT IMMEDIATELY UPON ARRIVAL

OUR RESPONSIBILITY FOR THIS SHIPMENT CEASED WHEN THE CARRIER SIGNED BILL OF LADING

If goods are received short or in damaged condition, it is important that you notify the carrier and insist on a notation of the loss or damage across the face of the freight bill. Otherwise no claim can be enforced against the transportation company.

If concealed loss or damage is discovered, notify your carrier at once and request an inspection. This is absolutely necessary. Unless you do this the carrier will not entertain any claim for loss or damage. The agent will make an inspection and grant a concealed damage notation. If you give the transportation company a clear receipt for goods that have been damaged or lost in transit, you do so at your own risk and expense.

WE, AT IR, ARE WILLING TO ASSIST YOU IN EVERY POSSIBLE MANNER TO COLLECT CLAIMS FOR LOSS OR DAMAGE, BUT THE WILLINGNESS ON OUR PART DOES NOT MAKE US RESPONSIBLE FOR COLLECTION OF CLAIMS OR REPLACEMENT OF MATERIAL. THE ACTUAL FILING AND PROCESSING OF THE CLAIM IS YOUR RESPONSIBILITY.

Ingersoll Rand Company

6.2 UNPACKING AND HANDLING

The compressor will normally be delivered with a polyethylene or other cover. If a knife has to be used to remove this cover, ensure that the exterior paintwork of the compressor is not damaged.

Incorporated within the base of the compressor are slots to enable a fork lift truck to move the machine. Ensure truck forks are fully engaged on both sides. Alternatively a special lifting frame can be utilized to enable a crane or hoist to move the compressor. Use only marked lifting points.

Once the packaging and pallet are discarded and the unit is in its final position, remove the transit brackets from the resilient mounts and store for future use or discard.

On N75-160 units remove the screw in the base and slide the separator tank service bracket into the upper position on the slots and tighten screws.

7.0 INSTALLATION

For technical information see section 8.0.

7.1 LOCATION IN PLANT

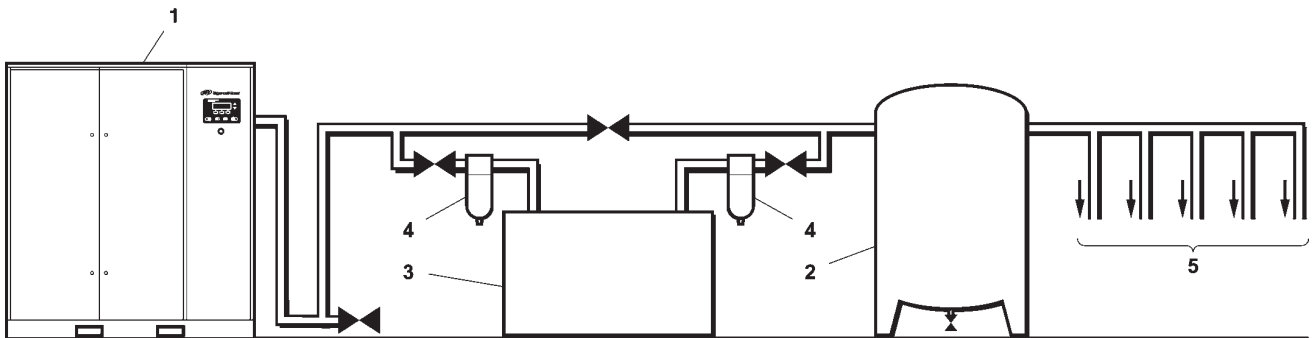

T5713
Revision 01
07/04

Ensure that the correct tie down points are used.

For major overhaul (i.e. motor removal) position the machine to obtain lifting access e.g. fork lift truck.

See diagram in reference section for minimum space requirements for normal operation and maintenance.

Ambient temperatures higher than 46° C (115° F) must be avoided as well as areas of high humidity.

Consider also the environment surrounding or near the compressor. The area selected for the location of the compressor should be free of dust, chemicals, metal filings, paint fumes and overspray.

Hard surfaces may reflect noise with an apparent increase in the decibel level. When sound transmission is important, a sheet of rubber or cork can be installed beneath the machine to reduce noise. Flexible piping may be required.

It is recommended that provision be made for lifting heavy components during major overhaul. Use only lifting points provided.

Minimum space in front of control panel door as required by National or Local codes must be maintained.

The compressor can be installed on any level floor capable of supporting it. A dry, well ventilated area where the atmosphere is as clean as possible is recommended.

Sufficient space all round and above the compressor must be allowed, to enable the effective removal of the cooling air which, in turn, will reduce the risk of recirculating the cooling air back through the compressor.

CAUTION

A minimum of 1 m (3.3ft) all round the compressor is recommended. If headroom is restricted, then the exhaust should be ducted or deflected away from the machine.

Screw type compressors [1] should not be installed in air systems with reciprocating compressors without means of isolation such as a common receiver tank. It is recommended that both types of compressor be piped to a common receiver using individual air lines.

The machine is shipped with the shipping restraints in place. Ensure that these are removed to allow free movement of the drive assembly during operation. Each restraint is painted yellow.

7.0 INSTALLATION

7.2 DISCHARGE AND CONDENSATE PIPING

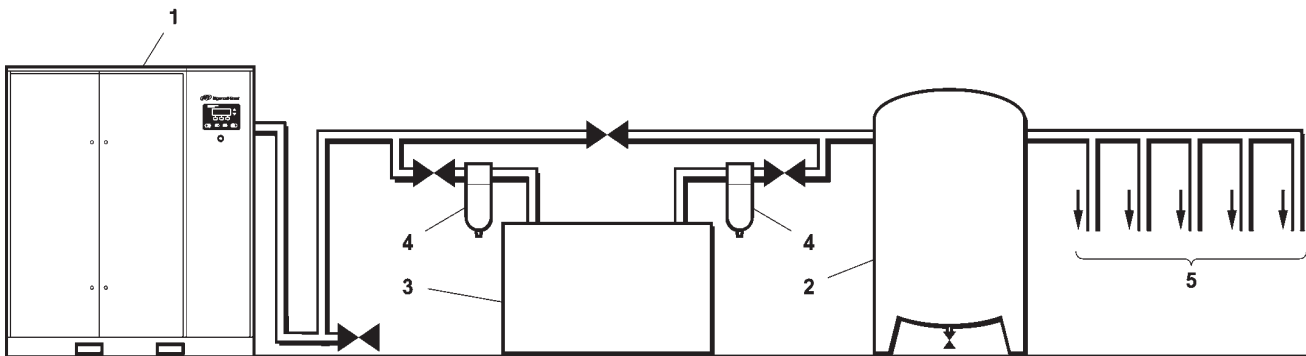

T5713
Revision 01
07/04

It is essential when installing a new compressor [1], to review the total air system. This is to ensure a safe and effective total system. One item which should be considered is liquid carryover. Installation of air dryers [3] is always good practice since properly selected and installed they can reduce any liquid carryover to zero.

A receiver [2] may be necessary to ensure that the total system volume is not less than 2.0 U.S. Gal. per rated delivery C.F.M.

Discharge piping should be at least as large as the discharge connection of the compressor. All piping and fittings should be suitably rated for the discharge pressure.

It is good practice to locate an isolation valve close to the compressor and to install line filters [4].

Include a means [6] to vent the discharge pipework downstream from the minimum pressure check valve located on the separator tank. Upstream of the first system isolation valve [7].

The discharged air contains a very small percentage of compressor lubricating oil and care should be taken to ensure that downstream equipment is compatible.

When two rotary units are operated in parallel, provide an isolation valve and drain trap for each compressor before the common receiver.

The built-in aftercooler reduces the discharge air temperature below the dew point (for most ambient conditions), therefore, considerable water vapor is condensed. To remove this condensation, each compressor with built-in aftercooler is furnished with a combination condensate separator/trap.

A dripleg assembly and isolation valve should be mounted near the compressor discharge. A drain line should be connected to the condensate drain in the base.

IMPORTANT: The drain line must slope downward from the base to work properly. For ease of inspection of the automatic drain trap operation, the drain piping should include an open funnel.

NOTICE

For low volume systems that may not include a receiver [2], compressor response time may need adjusting. Contact your local IR service agent.

CAUTION

The use of plastic bowls on line filters and other plastic air line components without metal guards can be hazardous. Their safety can be affected by either synthetic coolants or the additives used in mineral oils. From a safety standpoint, metal bowls should be used on any pressurized system.

NOTICE

Do not use the compressor to support the discharge pipe.

7.0 INSTALLATION

7.3 ELECTRICAL

⚠ CAUTION

This procedure should only be carried out by a qualified electrician, electrical contractor or your local Ingersoll Rand Distributor or Air Center.

The compressor and drive should be properly grounded / earthed in accordance with Local and National Code requirements.

Installation of this compressor must be in accordance with recognized electrical codes and any local Health and Safety Codes.

The compressor must have its own isolator situated adjacent to it. The fuse protecting the circuit and the compressor must be selected in accordance with local and national code requirements on the basis of the data provided in the general information section

Feeder cables should be sized by the customer/electrical contractor to ensure that the circuit is balanced and not overloaded by other electrical equipment. The length of wiring from a suitable electrical feed point is critical as voltage drops may impair the performance of the compressor.

Cable sizes may vary considerably so the mains terminals will accept up to 50mm² (1awg) (37/45k & 50/60H) and up to 90mm² (3/0awg) (55/75k & 75/100H) cable. The N75K–160K and N100H–200H machines mains terminals will accept 2 x 120mm² (4/0 AWG) cables. The N250H–300H–2S machines main terminals will accept 2 x 400 MCM cables.

Feeder cable connections to incoming terminals L1–L2–L3 should be tight and clean.

The applied voltage must be compatible with the motor and compressor data plate ratings.

The control circuit transformer has different voltage tapings. Ensure that these are set for the specific applied voltage prior to starting.

A hole is provided for incoming power connection. If it is necessary to make a hole in the control box in a different location, care should be taken to not allow metal shavings to enter the starter and other electrical components within the box. If another hole is used, the original hole must be blocked off.

The feeder cable must be suitably glanded into the power drive module (P.D.M.) electrical box to ensure that dirty air does not by-pass the filter pads or degrade the cooling air flow.

On completion of electrical installation, check that blower motor rotation is correct. N250H–300H utilizes a fan.

This machine is designed for use in heavy industrial environments, where the electricity supply is separated from nearby residential and commercial areas. If the machine is to be used in the light industrial, residential or commercial environment where the local supply network is shared, further radio frequency (RF) screening measures may be required. Consult your local distributor/supplier for details of the optional RF filter. RF filter supplied as standard on N250–300H–2S

The compressor has a anti-condensation heater and thermostat in the electrical box. This circuit can be connected to an independent electrical supply of either 110V or 230V single phase, dependant on the country of installation. The supply should be suitable fused and an independent isolator installed adjacent to the compressor.

This should be done in accordance with local and national codes. It is good practice and sometimes mandatory, to display suitable signs warning that the machine has two separate electrical supplies which both must be isolated before any work is attempted.

Alternately it can be supplied from the 110V tapping of the control transformer and connected as shown on schematic wiring diagram.

7.0 INSTALLATION

▲ CAUTION

VERY IMPORTANT

Supply voltage must be kept to a maximum imbalance of 2% on 50Hz and 3% on 60Hz applications. Voltage imbalances greater than these levels can cause permanent damage to the drive.

Compressor must not be subjected to any voltage spikes or surges in excess of 575V. Exposure to spikes/surges in excess of 575V can permanently damage the drive. If the possibility of such exists it is recommended that adequate surge protection is fitted such as an Ingersoll Rand line reactor. See your local Ingersoll Rand representative.

Failure of the drive due to voltage spikes, line notching, harmonics or other power quality related problems, will not be covered by the standard compressor warranty.

The correct type and rating of line input fuse **MUST BE** fitted onto the customers isolator or breaker close to the compressor. For Amp rating see technical information in Section 8.1.

Product Identification Class – J, Class – T, or Semiconductor	Fuse Type Fast Acting Class–J, T or Semiconductor type, Current limiting, Interrupt Rating – 200,000 Amps RMS SYM. Alternate fuse may be used if the time current characteristics are faster than fuses recommended in this section.
--	---

See your local Ingersoll Rand representative for a range of fuses and disconnect isolators matched to your particular machine.

Example of voltage imbalance calculation

U → V 462v

V → W 459v

W → U 453v

$$V(m) = (462 + 459 + 453) / 3 = 458v$$

$$V\Delta \text{ max} = 462 - 453 = 9v$$

$$= (9 / 458) \times 100 = 1.97\%$$

7.0 INSTALLATION

7.4 WATERCOOLED UNITS

Cooling Water Piping

Water piping to and from the compressor package must be 1" diameter or larger for N37/75K (N50/100H), 1 1/2" diameter or larger for N75/160K (N100H/200H) and 2.0" diameter or larger for N250/300H-2S. Isolation valves with side drains should be installed on both the inlet and outlet lines. Also a strainer of 2mm-mesh size should be installed on the inlet line. Strainers are available from Ingersoll Rand. Ingersoll Rand CPN 54689997 (N37/45K & N50/60H) or CPN 54690029 (N55/75K & N75/100H)

A normally closed solenoid valve is fitted to the water outlet side of the compressor package. This is wired into the compressor control circuit and closes when the compressor stops.

Carefully inspect your water system before installing the compressor package. Ensure that the piping is free of scale and deposits that may restrict water flow to the compressor package.

Proper operation of your compressor requires that the water flow listed below be provided at a maximum supply temperature of 46° C (115° F).

Model Range	Minimum cooling water requirement vs water inlet temperatures, in litres per minute (US gallons per minute)			
	10°F / 50°F	21°F / 70°F	32°C / 90°F	46°C / 115°F
N37	23(6.0)	23 (6.0)	38 (10.0)	57(15.0)
N45	27(7.0)	30(8.0)	49(13.0)	76(20.0)
N55	51(13.5)	46(12.0)	38(10.0)	38(10.0)
N75	95(25.0)	68(18.0)	46(12.0)	53(14.0)
N75-2S	175(46.0)	133(35.0)	106(28.0)	76(20.0)
N90	84(22.0)	72(19.0)	65(17.0)	72(19.0)
N110	95(25.0)	80(21.0)	72(19.0)	87(23.0)
N132	110(29.0)	91(24.0)	87(23.0)	106(28.0)
N160	125(33.0)	118(31.0)	106(28.0)	125(33.0)
N250	91(24.0)	110(29.0)	179(47.0)	
N300	95(25.0)	133(35.0)	220(58.0)	

Water temperature and pressure gauges should be installed in the water piping for use in any fault finding of the water system. Water pressure should ideally be between 3 and 5 bar (43.5 and 72.5 psi) but must not be above 10 Bar (145 psi)

Water cleanliness is also extremely important. Cleaning of coolers as a result of fouling is a customer responsibility. Therefore, it is highly recommended that proper water quality must meet the requirements listed in WATER QUALITY RECOMMENDATIONS later in this section.

Venting the water system

At the initial installation or for start-up after draining the water system proceed to vent the system as follows.

1. Locate the water system vent cocks on top of the aftercooler and lubricant cooler.
2. Open the water valve(s) allowing water to flow to the package.
3. Open the vent cocks and allow all air to escape from the system. When water is observed at the vent cocks, close them.

The system is now vented.

Draining the water system

Should it become necessary to completely drain the water system, proceed as follows.

1. Disconnect the inlet and discharge water lines from the connections located at the rear of the unit.
2. Locate the aftercooler and lubricant cooler. Remove the drain plugs located at the bottom of the coolers. Allow the system to completely drain.

N75-160k, N100-200H Watercooled

See piping and instrumentation diagram (Section 8.3). The coolers are piped in a "parallel" water flow arrangement with a manual trim valve controlling the flow through the aftercooler. An additional automatic anti-condensation thermal valve controls the flow of water to the oilcooler. It has a sensor in the separator tank and capillary to signal the valve to open and close in order to avoid water condensing in the tank.

Adjusting the Aftercooler Trim Valve

The anti-condensation valve has no adjustment. The Aftercooler Trim Valve is factory set and should not need adjusting but if disturbed use following procedure. Close valve fully clockwise and then open 1/4 turn. With machine running loaded observe the package discharge temperature Intellisys display. It should be approx 15° F (8° C) above the water inlet temperature. If it is higher, open the valve a little more. Put a 'Warning - Do Not Adjust' label on the valve or fit a lock.

7.0 INSTALLATION

Water quality recommendations

Water quality recommendations Water quality is often overlooked when the cooling system of a water-cooled air compressor is examined. Water quality determines how effective the heat transfer rate, as well as the flow rate will remain during the life of the unit. It should be noted that the quality of water used in any cooling system does not remain constant during the operation of the system. Evaporation, corrosion, chemical and temperature changes, aeration, scale and biological formations effect the water makeup. Most problems in a cooling system show up first in a reduction in the heat transfer rate, then in a reduced flow rate and finally with damage to the system.

Scale: Scale formation inhibits effective heat transfer, yet it does help prevent corrosion. Therefore, a thin uniform coating of calcium carbonate is desired on the inner surface. Perhaps the largest contributor to scale formation is the precipitation of calcium carbonate out of the water. This is dependent on temperature and pH. The higher the pH value, the greater the chance of scale formation. Scale can be controlled with water treatment.

Corrosion: In contrast to scale formation is the problem of corrosion. Chlorides cause problems because of their size and conductivity. Low pH levels promote corrosion, as well as high levels of dissolved oxygen.

Fouling: Biological and organic substances (slime) can also cause problems, but in elevated temperature environments such as cooling processes they are not a major concern. If they create problems with clogging, commercial shock treatment are available.

To ensure good operation life and performance of the compressor cooling system, the recommended acceptable ranges for different water constituents are included below:

Cooling Water Analysis Chart

Substances	Test interval	Acceptable concentration
Corrosivity (Hardness, pH, Total Dissolved Solids, Temperature at inlet Alkalinity)	Monthly - if stable for 3 to 4 months, analyse quarterly.	Langelier Index 0 to 1
Iron	Monthly	<2 ppm
Sulphate	Monthly	<50 ppm
Chloride	Monthly	<50 ppm
Nitrate	Monthly	<2 ppm
Silica	Monthly	< 100 ppm
Desolated Oxygen	Daily - if stable, analyse weekly	0 ppm (as low as possible)
Oil & Grease	Monthly	<5 ppm
Ammonia	Monthly	<1 ppm

7.0 INSTALLATION

7.5 SEA WATERCOOLED UNITS (SELECTED UNITS ONLY)

Water cleanliness is extremely important. Strainers are available from Ingersoll Rand. Cleaning of coolers as a result of fouling is a customer responsibility.

Isolation valves with side drains should be installed on both the inlet and outlet lines.

A normally closed solenoid valve is fitted to the water outlet side of the compressor package.

It is important to ensure that the recommended flow rate cannot be exceeded. This will normally mean that an orifice plate must be fitted in the pipework at least 1m (3.3ft) before the cooler, with the orifice size calculated to ensure that the maximum sea water flow rate cannot be exceeded. If these precautions are not taken, it is possible that the sea water flow rate through the cooler may be several times the recommended maximum, which will lead to rapid failure.

No oil cooler manufacturer can guarantee that its products will have an indefinite life and for this reason, we suggest that the cooling system is designed to minimize any damage caused by a leaking oil cooler. This can be achieved as follows ;

1. The oil pressure should be higher than the sea water pressure, so that in the event of a leak occurring, the oil will not be contaminated.
2. If the sea water pressure is 100PSIG (7BARG) or above it is recommended that the water solenoid valve is changed to the water inlet side. This will protect the system from high pressure surges when not in use.
3. The sea water outlet pipe from the cooler should have a free run to waste.

Sea Water Pressure Bar (psi)	Orifice diameter in mm (inch) to give a maximum sea water flow of 90l/min (23.76 US gall/min)
3 (43.5)	12 (0.472)
4 (58)	11 (0.433)
5 (72.5)	10 (0.394)
6 (87)	9.6 (0.378)
7 (101.5)	9.2 (0.362)
8 (116)	8.9 (0.35)
9 (130.5)	8.7 (0.343)
10 (145)	8.4 (0.33)

7.0 INSTALLATION

7.6 OUTDOOR SHELTERED INSTALLATION

Nirvana compressors are not suitable for outdoor installation.

Installing a Nirvana compressor outside voids the warranty of the compressor.

8.0 GENERAL INFORMATION

TECHNICAL INFORMATION-SINGLE STAGE				
	N37K	N45K	N50H	N60H
General				
Sound pressure level dB(A) *	75	75	75	75
Maximum ambient temperature ° C (° F)	46 (115)	46 (115)	46 (115)	46 (115)
Minimum ambient temperature ° C (° F)	1.7 (35)	1.7 (35)	1.7 (35)	1.7 (35)
Weight Kg (lbs)	1048 (2310)	1048 (2310)	1048 (2310)	1048 (2310)
Maximum pressure barg (psig)	10 (145)	10 (145)	10 (145)	10 (145)
Minimum pressure barg (psig)	4.5 (65)	4.5 (65)	4.5 (65)	4.5 (65)
Coolant capacity litres (US gal)	18 (4.8)	18 (4.8)	18 (4.8)	18 (4.8)
HAT switch setting ° C (° F)	120 (248)	120 (248)	120 (248)	120 (248)
Performance **				
Flow at 7.5 Barg (m ³ /min)	6.43	7.39	–	–
Flow at 8.5 Barg (m ³ /min)	6.12	7.02	–	–
Flow at 10 Barg (m ³ /min)	5.83	6.46	–	–
Flow at 100 psig (cfm)	–	–	235	262
Flow at 125 psig (cfm)	–	–	216	248
Flow at 140 psig (cfm)	–	–	209	233
Air Cooling System				
Cooling air flow m ³ /min (cfm)	184 (6500)	184 (6500)	184 (6500)	184 (6500)
Maximum ΔP in air ducts Pa (inch WG)	124 (0.5)	124 (0.5)	124 (0.5)	124 (0.5)
Compressed air outlet ΔT ° C (° F)	8 (15)	8 (15)	8 (15)	8 (15)
Water Cooling System				
Cooling (clean) water flow l/min (US gallon/min) @ 10 ° C (50 ° F) / 32 ° C (90 ° F)	23/38 (6/10)	27/49 (7/13)	23/38 (6/10)	27/49 (7/13)
Maximum ΔP in air ducts Pa (inch WG)	62 (0.25)	62 (0.25)	62 (0.25)	62 (0.25)
Compressed air outlet ΔT ° C (° F)	14 (25)	14 (25)	14 (25)	14 (25)
Main Power Circuit A/C (W/C) ***				
Package full load current at 220V (A) **	140 (131)	168 (159)	140 (131)	168 (159)
Package full load current at 400V (A) **	75 (70)	90 (85)	–	–
Package full load current at 460V (A) **	–	–	68 (63)	81 (77)
Package full load current at 575V (A) **	–	–	56 (52)	67 (63)
Max fuse size @ 220V (A)	250	250	250	250
Max fuse size @ 400V (A)	125	125	125	125
Max fuse size @ 460V (A)	125	125	125	125
Max fuse size @ 575V (A)	100	100	100	100
Fuse type	Fast acting class J, T or semiconductor type, current limiting interrupt rating 200, 000 Amps RMS SYM.			
Heater Circuit				
110V Single Phase Rating (A)	4	4	4	4
230V Single Phase Rating (A)	4	4	4	4
Fuse type	General purpose			

* In accordance with PNEUROP PN8NTC2.3

** Tolerances in accordance with ISO 1217

*** Always apply local electrical codes for sizing cables and fusing. In the absence of local codes the minimum cable size should be calculated on basis of mean package full load current X1.25 (i.e. 25% margin)

8.0 GENERAL INFORMATION

	N55K	N75K	N75H	N100H
General				
Sound pressure level dB(A) *	75	75	75	75
Maximum ambient temperature ° C (° F)	46 (115)	46 (115)	46 (115)	46 (115)
Minimum ambient temperature ° C (° F)	1.7 (35)	1.7 (35)	1.7 (35)	1.7 (35)
Weight Kg (lbs)	1531 (3374)	1531 (3374)	1531 (3374)	1531 (3374)
Maximum pressure barg (psig)	10 (145)	10 (145)	10 (145)	10 (145)
Minimum pressure barg (psig)	4.5 (65)	4.5 (65)	4.5 (65)	4.5 (65)
Coolant capacity litres (US gal)	30 (8)	30 (8)	30 (8)	30 (8)
HAT switch setting ° C (° F)	120 (248)	120 (248)	120 (248)	120 (248)
Performance				
Flow at 7.5 Barg (m3/min)	10.11	12.94	–	–
Flow at 8.5 Barg (m3/min)	9.29	12.15	–	–
Flow at 10 Barg (m3/min)	8.49	11.50	–	–
Flow at 100 psig (cfm)	–	–	372	479
Flow at 125 psig (cfm)	–	–	328	429
Flow at 140 psig (cfm)	–	–	306	413
Air Cooling System				
Cooling air flow m3/min (cfm)	241 (8500)	241 (8500)	241 (8500)	241 (8500)
Maximum ΔP in air ducts Pa (inch WG)	124 (0.5)	124 (0.5)	124 (0.5)	124 (0.5)
Compressed air outlet ΔT° C (° F)	8 (15)	8 (15)	8 (15)	8 (15)
Water Cooling System				
Cooling (clean) water flow l/min (US gallon/min) @ 10 ° C (50 ° F) / 32 ° C (90 ° F)	51/38 (13.5 /10)	95/46 (25 /12)	51/38 (13.5/10)	95/46 (25/12)
Maximum ΔP in air ducts Pa (inch WG)	62 (0.25)	62 (0.25)	62 (0.25)	62 (0.25)
Compressed air outlet ΔT° C (° F)	14 (25)	14 (25)	14 (25)	14 (25)
Main Power Circuit A/C (W/C) ***				
Package full load current at 220V (A) **	208 (196)	–	208 (196)	–
Package full load current at 400V (A) **	110 (104)	144 (138)	–	–
Package full load current at 460V (A) **	–	–	100 (94)	131 (125)
Package full load current at 575V (A) **	–	–	82 (78)	108 (103)
Max fuse size @ 220V (A)	300	400	300	400
Max fuse size @ 400V (A)	150	200	150	200
Max fuse size @ 460V (A)	150	200	150	200
Max fuse size @ 575V (A)	125	150	125	150
Fuse type	Fast acting class J, T or semiconductor type, current limiting interrupt rating 200, 000 Amps RMS SYM.			
Heater Circuit				
110V Single Phase Rating (A)	4	4	4	4
230V Single Phase Rating (A)	4	4	4	4
Fuse type	General purpose			

* In accordance with PNEUROP PN8NTC2.3

** Tolerances in accordance with ISO 1217

*** Always apply local electrical codes for sizing cables and fusing. In the absence of local codes the minimum cable size should be calculated on basis of mean package full load current X1.25 (i.e. 25% margin)

8.0 GENERAL INFORMATION

	N90K	N110K	N125H	N150H
General				
Sound pressure level dB(A) *	75	75	75	75
Maximum ambient temperature ° C (° F)	46 (115)	46 (115)	46 (115)	46 (115)
Minimum ambient temperature ° C (° F)	1.7 (35)	1.7 (35)	1.7 (35)	1.7 (35)
Weight Kg (lbs)	3175 (6985)	3175 (6985)	3175 (6985)	3175 (6985)
Maximum pressure barg (psig)	10 (145)	10 (145)	10 (145)	10 (145)
Minimum pressure barg (psig)	4.5 (65)	4.5 (65)	4.5 (65)	4.5 (65)
Coolant capacity litres (US gal)	91 (24)	91 (24)	91 (24)	91 (24)
HAT switch setting ° C (° F)	120 (248)	120 (248)	120 (248)	120 (248)
Performance **				
Flow at 7.5 Barg (m3/min)	17.1	20.0	–	–
Flow at 8.5 Barg (m3/min)	15.3	19.2	–	–
Flow at 10 Barg (m3/min)	14.0	17.5	–	–
Flow at 100 psig (cfm)	–	–	655	739
Flow at 125 psig (cfm)	–	–	571	670
Flow at 140 psig (cfm)	–	–	524	610
Air Cooling System				
Cooling air flow m3/min (cfm)	382 (13500)	382 (13500)	382 (13500)	382 (13500)
Maximum ΔP in air ducts Pa (inch WG)	124 (05)	124 (05)	124 (05)	124 (05)
Compressed air outlet ΔT ° C (° F)	8 (15)	8 (15)	8 (15)	8 (15)
Water Cooling System				
Cooling (clean) water flow l/min (US gallon/min) @ 10° C (50° F) / 32° C (90° F)	84/65 (22/17)	95/72 (25/19)	84/65 (22/17)	95/72 (25/19)
Maximum ΔP in air ducts Pa (inch WG)	62 (0.25)	62 (0.25)	62 (0.25)	62 (0.25)
Compressed air outlet ΔT ° C (° F)	14 (25)	14 (25)	14 (25)	14 (25)
Main Power Circuit A/C (W/C) ***				
Package full load current at 400V (A) **	182 (170)	218 (206)	–	–
Package full load current at 460V (A) **	–	–	170 (160)	200 (190)
Package full load current at 575V (A) **	–	–	140 (132)	165 (157)
Max fuse size @ 380V – 415V (A)	250	350	–	–
Max fuse size @ 440V – 480V (A)	–	–	250	250
Max fuse size @ 550V – 575V (A)	–	–	200	200
Fuse type	Fast acting class J, T or semiconductor type, current limiting interrupt rating 200, 000 Amps RMS SYM.			
Heater Circuit				
110V Single Phase Rating (A)	4	4	4	4
230V Single Phase Rating (A)	4	4	4	4
Fuse type	General purpose			

* In accordance with PNEUROP PN8NTC2.3

** Tolerances in accordance with ISO 1217

*** Always apply local electrical codes for sizing cables and fusing. In the absence of local codes the minimum cable size should be calculated on basis of mean package full load current X1.25 (i.e. 25% margin)

8.0 GENERAL INFORMATION

	N132K	N160K	N200H
General			
Sound pressure level dB(A) *	75	75	75
Maximum ambient temperature ° C (° F)	46 (115)	46 (115)	46 (115)
Minimum ambient temperature ° C (° F)	1.7 (35)	1.7 (35)	1.7 (35)
Weight Kg (lbs)	3175 (6985)	3175 (6985)	3175 (6985)
Maximum pressure barg (psig)	10 (145)	10 (145)	10 (145)
Minimum pressure barg (psig)	4.5 (65)	4.5 (65)	4.5 (65)
Coolant capacity litres (US gal)	91 (24)	91 (24)	91 (24)
HAT switch setting ° C (° F)	120 (248)	120 (248)	120 (248)
Performance **			
Flow at 7.5 Barg (m3/min)	23.5	28.0	–
Flow at 8.5 Barg (m3/min)	22.3	26.0	–
Flow at 10 Barg (m3/min)	21.0	25.0	–
Flow at 100 psig (cfm)	–	–	993
Flow at 125 psig (cfm)	–	–	892
Flow at 140 psig (cfm)	–	–	819
Air Cooling System			
Cooling air flow m3/min (cfm)	382 (13500)	382 (13500)	382 (13500)
Maximum ΔP in air ducts Pa (inch WG)	124 (0.5)	124 (0.5)	124 (0.5)
Compressed air outlet ΔT ° C (° F)	8 (15)	8 (15)	8 (15)
Water Cooling System			
Cooling (clean) water flow l/min (US gallon/min) @ 10° C (50° F) / 32° C (90° F)	110/87 (29/23)	125/106 (33/28)	125/106 (33/28)
Maximum ΔP in air ducts Pa (inch WG)	62 (0.25)	62 (0.25)	62 (0.25)
Compressed air outlet ΔT ° C (° F)	14 (25)	14 (25)	14 (25)
Main Power Circuit A/C (W/C) ***			
Package full load current at 400V (A) **	251 (239)	301(289)	–
Package full load current at 460V (A) **	–	–	255 (245)
Package full load current at 575V (A) **	–	–	210 (202)
Max fuse size @ 380V – 415V (A)	350	450	–
Max fuse size @ 440V – 480V (A)	–	–	350
Max fuse size @ 550V – 575V (A)	–	–	300
Fuse type	Fast acting class J, T or semiconductor type, current limiting interrupt rating 200, 000 Amps RMS SYM.		
Heater Circuit			
110V Single Phase Rating (A)	4	4	4
230V Single Phase Rating (A)	4	4	4
Fuse type	General purpose		

* In accordance with PNEUROP PN8NTC2.3

** Tolerances in accordance with ISO 1217

*** Always apply local electrical codes for sizing cables and fusing. In the absence of local codes the minimum cable size should be calculated on basis of mean package full load current X1.25 (i.e. 25% margin)

8.0 GENERAL INFORMATION

8.1 TECHNICAL INFORMATION – TWO STAGE

	N75K	N90K	N110K	N100H	N125H	N150H
General						
Sound pressure level dB(A) *	75	75	75	75	75	75
Maximum ambient temperature ° C (° F)	46 (115)	46 (115)	46 (115)	46 (115)	46 (115)	46 (115)
Minimum ambient temperature ° C (° F)	1.7 (35)	1.7 (35)	1.7 (35)	1.7 (35)	1.7 (35)	1.7 (35)
Weight Kg (lbs)	3650 (8030)	3650 (8030)	3650 (8030)	3650 (8030)	3650 (8030)	3650 (8030)
Maximum pressure barg (psig)	10 (145)	10 (145)	10 (145)	10 (145)	10 (145)	10 (145)
Minimum pressure barg (psig)	4.5 (65)	4.5 (65)	4.5 (65)	4.5 (65)	4.5 (65)	4.5 (65)
Coolant capacity litres (US gal)	95 (25)	95 (25)	95 (25)	95 (25)	95 (25)	95 (25)
HAT switch setting ° C (° F)	120 (248)	120 (248)	120 (248)	120 (248)	120 (248)	120 (248)
Performance **						
Flow at 7.5 Barg (m3/min)	15.7	18.0	22.1	–	–	–
Flow at 8.5 Barg (m3/min)	14.2	17.5	20.4	–	–	–
Flow at 10 Barg (m3/min)	13.1	15.4	18.9	–	–	–
Flow at 14 Barg (m3/min)	–	12.5	15.4	–	–	–
Flow at 100 psig (cfm)	–	–	–	560	690	825
Flow at 125 psig (cfm)	–	–	–	504	621	743
Flow at 140 psig (cfm)	–	–	–	470	580	693
Flow at 200 psig (cfm)	–	–	–	–	443	548
Air Cooling System						
Cooling air flow m3/min (cfm)	382 (13500)	382 (13500)	382 (13500)	382 (13500)	382 (13500)	382 (13500)
Maximum ΔP in air ducts Pa (inch WG)	124 (0.5)	124 (0.5)	124 (0.5)	124 (0.5)	124 (0.5)	124 (0.5)
Compressed air outlet ΔT ° C (° F)	8 (15)	8 (15)	8 (15)	8 (15)	8 (15)	8 (15)
Water Cooling System						
Cooling (clean) water flow l/min (US gallon/min) @ 10° C (50° F) / 32° C (90° F)	175/106 (46/28)	84/65 (22/17)	95/72 (25/19)	175/106 (46/28)	84/65 (22/17)	95/72 (25/19)
Maximum ΔP in air ducts Pa (inch WG)	62 (0.25)	62 (0.25)	62 (0.25)	62 (0.25)	62 (0.25)	62 (0.25)
Compressed air outlet ΔT ° C (° F)	14 (25)	14 (25)	14 (25)	14 (25)	14 (25)	14 (25)
Main Power Circuit A/C (W/C)***						
Package full load current at 400V (A) **	153 (142)	182 (170)	218 (206)	–	–	–
Package full load current at 460V (A) **	–	–	–	139 (129)	170 (160)	200 (190)
Package full load current at 575V (A) **	–	–	–	114 (106)	140 (132)	165 (157)
Max fuse size @ 380V – 415V (A)	250	250	350	–	–	–
Max fuse size @ 440V – 480V (A)	–	–	–	200	250	250
Max fuse size @ 550V – 575V (A)	–	–	–	200	200	200
Fuse type	Fast acting class J, T or semiconductor type, current limiting interrupt rating 200,000 Amps RMS SYM.					
Heater Circuit						
110V Single Phase Rating (A)	4	4	4	4	4	4
230V Single Phase Rating (A)	4	4	4	4	4	4
4Fuse type	General purpose					

* In accordance with PNEUROP PN8NTC2.3

** Tolerances in accordance with ISO 1217

*** Always apply local electrical codes for sizing cables and fusing. In the absence of local codes the minimum cable size should be calculated on basis of mean package full load current X1.25 (i.e. 25% margin)

8.0 GENERAL INFORMATION

	N132K	N160K	N200H	N250H	N300H
General					
Sound pressure level dB(A) *	75	75	75	80	80
Maximum ambient temperature ° C (° F)	46 (115)	46 (115)	46 (115)	46 (115)	46 (115)
Minimum ambient temperature ° C (° F)	1.7 (35)	1.7 (35)	1.7 (35)	1.7 (35)	1.7 (35)
Weight Kg (lbs)	3650 (8030)	3650 (8030)	3650 (8030)	5933 (13,080)	5933 (13,080)
Maximum pressure barg (psig)	10 (145)	10 (145)	10 (145)	10 (145)	10 (145)
Minimum pressure barg (psig)	4.5 (65)	4.5 (65)	4.5 (65)	4.5 (65)	4.5 (65)
Coolant capacity litres (US gal)	95 (25)	95 (25)	95 (25)	152 (40)	152 (40)
HAT switch setting ° C (° F)	120 (248)	120 (248)	120 (248)	120 (248)	120 (248)
Performance **					
Flow at 7.5 Barg (m3/min)	26.2	31.1	–	–	–
Flow at 8.5 Barg (m3/min)	24.2	29.6	–	–	–
Flow at 10 Barg (m3/min)	23.1	27.2	–	–	–
Flow at 14 Barg (m3/min)	18.4	22.2	–	–	–
Flow at 100 psig (cfm)	–	–	1100	1380	1690
Flow at 125 psig (cfm)	–	–	990	1249	1527
Flow at 140 psig (cfm)	–	–	924	1167	1430
Flow at 200 psig (cfm)	–	–	735	–	–
Air Cooling System					
Cooling air flow m3/min (cfm)	382 (13500)	382 (13500)	382 (13500)	679 (24000)	679 (24000)
Maximum ΔP in air ducts Pa (inch WG)	124 (0.5)	124 (0.5)	124 (0.5)	62 (0.25)	62 (0.25)
Compressed air outlet ΔT ° C (° F)	8 (15)	8 (15)	8 (15)	8 (15)	8 (15)
Water Cooling System					
Cooling (clean) water flow l/min (US gallon/min) @ 10° C (50° F) / 32° C (90° F) ****	110/87 (29/23)	125/106 (33/28)	125/106 (33/28)	352 (93)	352 (93)
Maximum ΔP in air ducts Pa (inch WG)	62 (0.25)	62 (0.25)	62 (0.25)	62 (0.25)	62 (0.25)
Compressed air outlet ΔT ° C (° F)	14 (25)	14 (25)	14 (25)	14 (25)	14 (25)
Main Power Circuit A/C (W/C) ***					
Package full load current at 400V (A) **	251 (239)	301 (289)	–	–	–
Package full load current at 460V (A) **	–	–	255 (245)	335 (313)	406 (384)
Package full load current at 575V (A) **	–	–	210 (202)	267 (250)	324 (307)
Max fuse size @ 380V – 415V (A)	350	450	–	–	–
Max fuse size @ 440V – 480V (A)	–	–	350	–	600
Max fuse size @ 550V – 575V (A)	–	–	300	–	500
Fuse type	Fast acting class J, T or semiconductor type, current limiting interrupt rating 200, 000 Amps RMS SYM.				
Heater Circuit					
110V Single Phase Rating (A)	4	4	4	4	4
230V Single Phase Rating (A)	4	4	4	4	4
Fuse type	General purpose				

* In accordance with PNEUROP PN8NTC2.3

** Tolerances in accordance with ISO 1217

*** Always apply local electrical codes for sizing cables and fusing. In the absence of local codes the minimum cable size should be calculated on basis of mean package full load current X1.25 (i.e. 25% margin)

**** Cooling water flow for N250H and N300H are @ 46 deg C (115 deg F)

8.0 GENERAL INFORMATION

8.2 INSTALLATION DRAWING—N37/45K—CC & N50/60H—CC – AIR COOLED

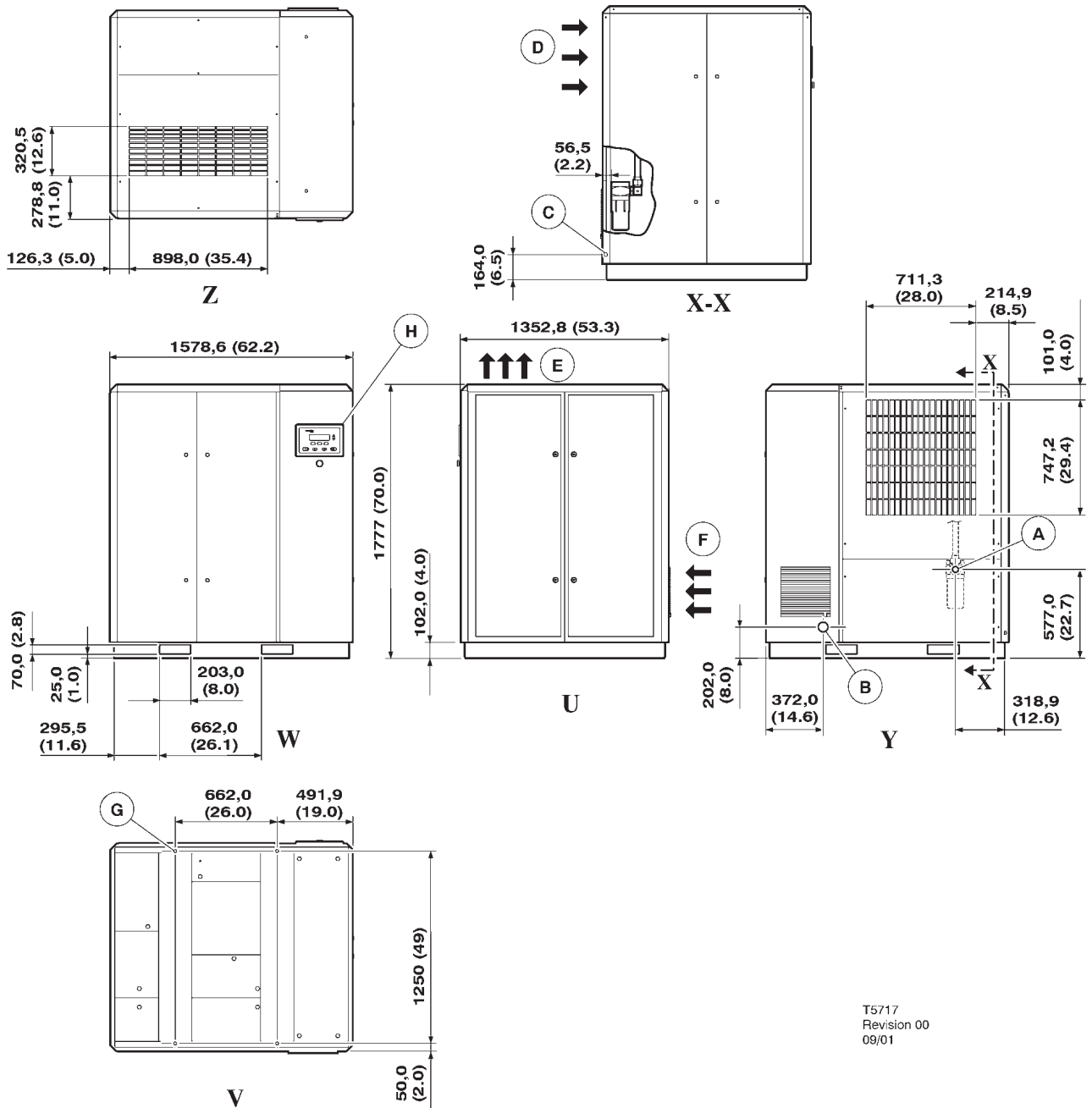

T5717
Revision 00
09/01

KEY

- | | |
|--|--|
| <p>A 11/2" NPT Air discharge (Female) 60Hz units
11/2" BSP Air discharge (Female) 50Hz units</p> <p>B Ø63mm (2.48") Electrical inlet</p> <p>C 0.38" NPT (Female)</p> <p>Note: Pipe condensate drain lines separately to an open drain due to differences in drain pressures. Use drain lines at least as large as the connection. Read operations manual and check local regulations</p> <p>D Cooling airflow</p> <p>E Exhaust airflow</p> <p>F Cabinet cooling airflow</p> | <p>G 4 x Ø 13.0mm (0.5") Compressor should be bolted to the floor with four M10 (0.38") bolts using holes shown. Seal base to floor with cork or rubber.</p> <p>H INTELLISYS Controller</p> <p>U Right</p> <p>V Bottom</p> <p>W Front</p> <p>X-X Section through X-X</p> <p>Y Rear view</p> <p>Z Plan view</p> |
|--|--|

8.0 GENERAL INFORMATION

8.2 INSTALLATION DRAWING– N37/45K–CC & N50/60H–CC – WATER COOLED

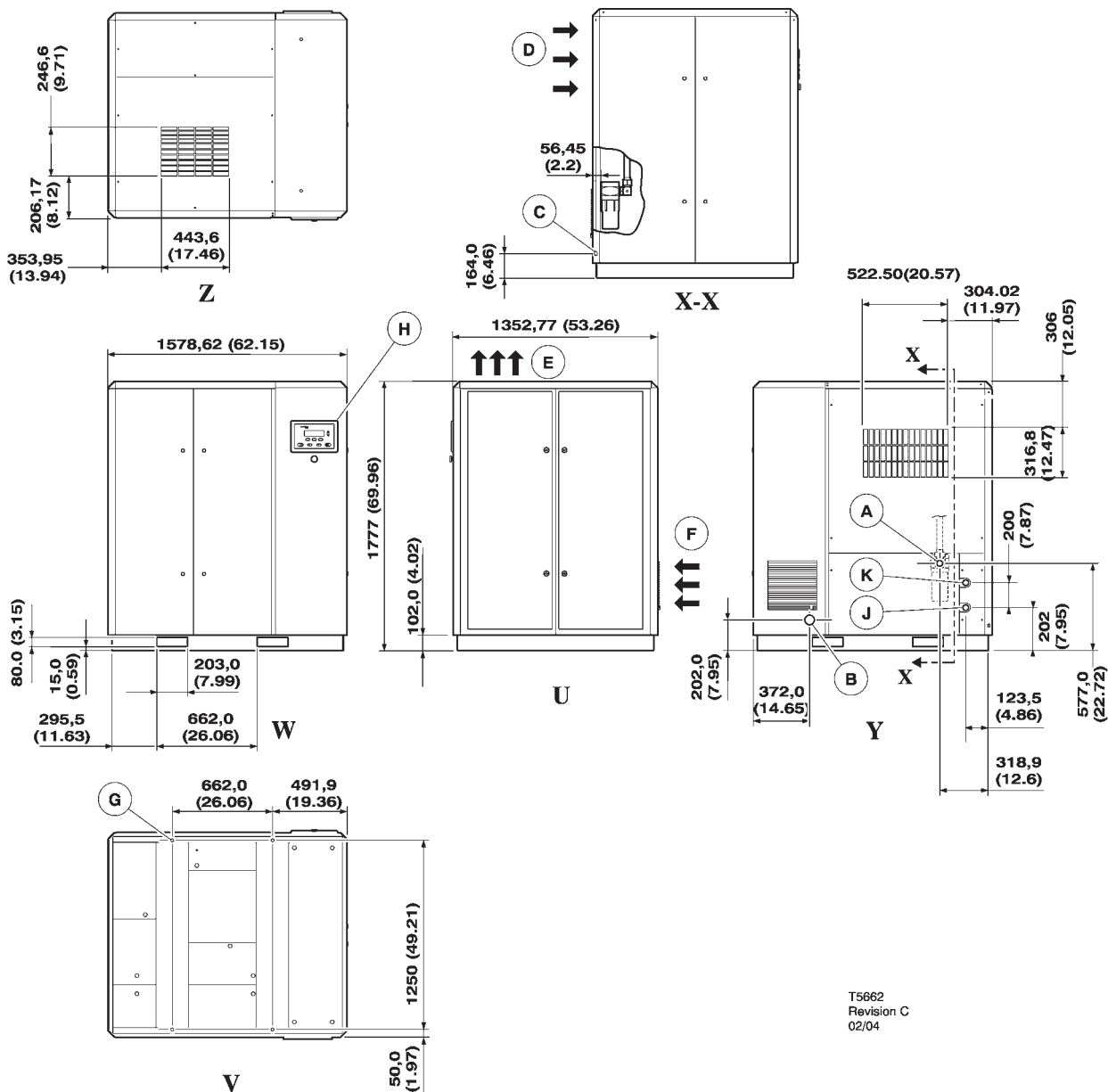

KEY

<p>A 1 1/2" NPT Air discharge (Female) 60Hz units 1 1/2" BSP Air discharge (Female) 50Hz units</p> <p>B Ø63mm (2.48") Electrical inlet</p> <p>C 0.38" NPT (Female)</p> <p>Note: Pipe condensate drain lines separately to an open drain due to differences in drain pressures. Use drain lines at least as large as the connection. Read operations manual and check local regulations</p> <p>D Cooling airflow</p> <p>E Exhaust airflow</p> <p>F Cabinet cooling airflow</p> <p>G 4 x Ø 13.0mm (0,5") Compressor should be bolted to the floor with four M10 (0.38") bolts using holes shown. Seal base to floor with cork or rubber.</p>	<p>H INTELLISYS Controller</p> <p>J 1" NPT Water inlet (Female) 60Hz units 1" BSP Water inlet (Female) 50Hz units</p> <p>K 1" NPT Water outlet (Female) 60Hz units 1" BSP Water outlet (Female) 50Hz units</p> <p>U Right</p> <p>V Bottom</p> <p>W Front</p> <p>X-X Section through X-X</p> <p>Y Rear view</p> <p>Z Plan view</p>
--	--

8.0 GENERAL INFORMATION

8.2 INSTALLATION DRAWING – N55/75K–CC & N75/100H–CC – AIR COOLED

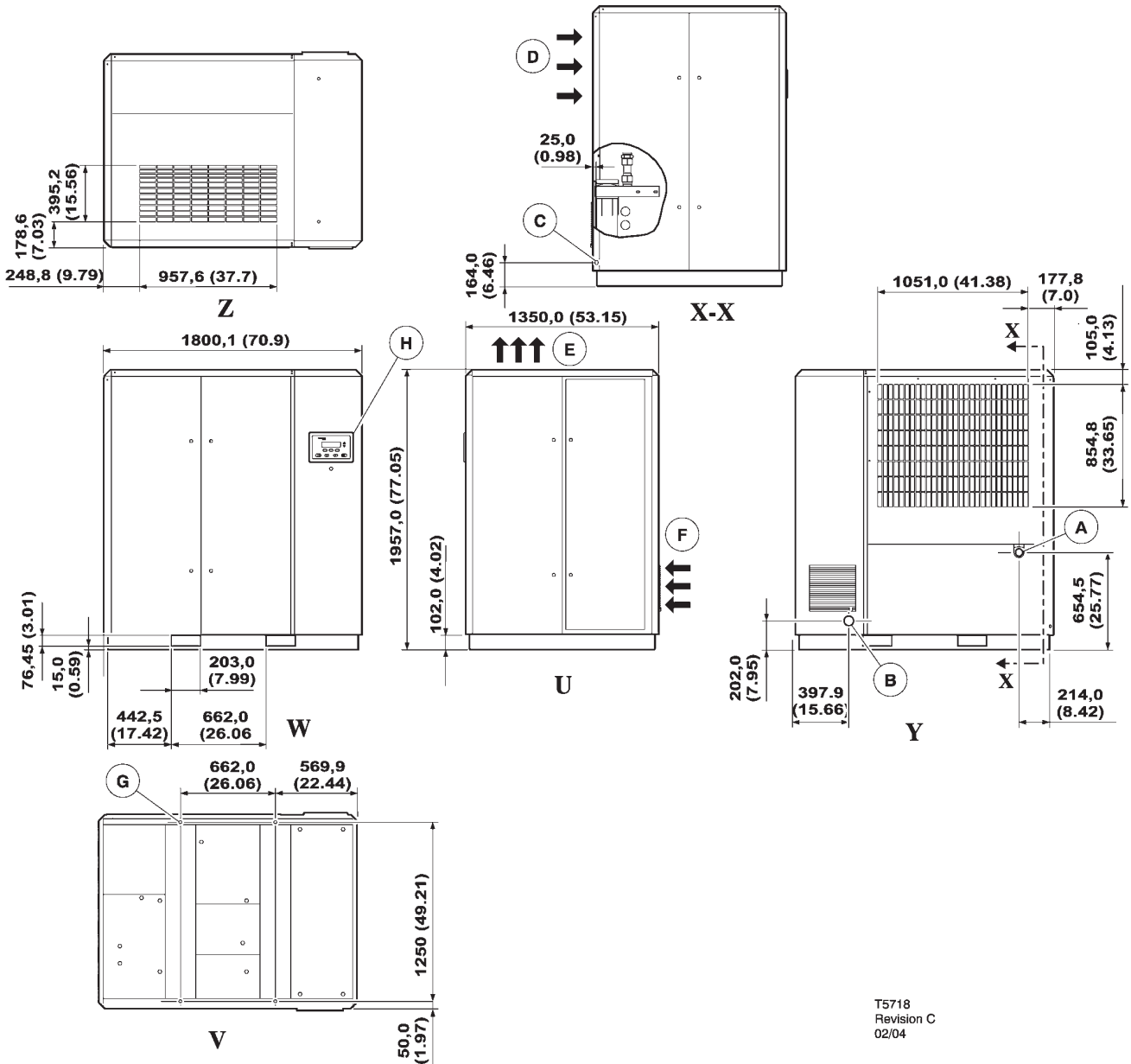

T5718
Revision C
02/04

KEY

- A** 2" NPT Air discharge (Female) 60Hz units
2" BSP Air discharge (Female) 50Hz units
- B** Ø63mm (2.48") Electrical inlet
- C** 0.38" NPT (Female)

Note: Pipe condensate drain lines separately to an open drain due to differences in drain pressures. Use drain lines at least as large as the connection. Read operations manual and check local regulations

- D** Cooling airflow
- E** Exhaust airflow
- F** Cabinet cooling airflow

- G** 4 x Ø 13.0mm (0,5")
Compressor should be bolted to the floor with four M10 (0.38") bolts using holes shown. Seal base to floor with cork or rubber.
- H** INTELLISYS Controller
- U** Right
- V** Bottom
- W** Front
- X-X** Section through X-X
- Y** Rear view
- Z** Plan view

8.0 GENERAL INFORMATION

8.2 INSTALLATION DRAWING—N55/75K—CC & N75/100H—CC—WATER COOLED

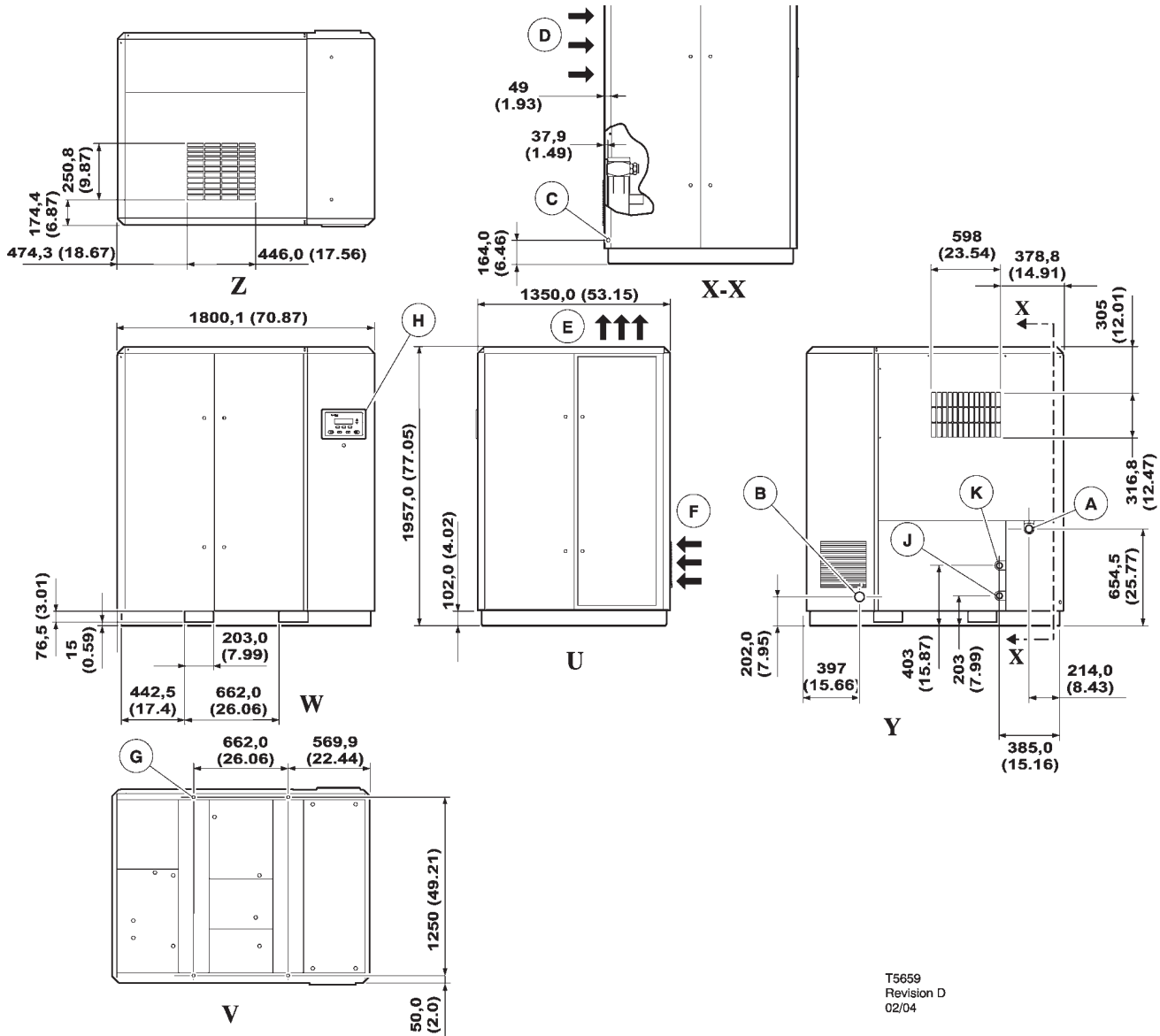

8.0 GENERAL INFORMATION

8.2 INSTALLATION DRAWING – N90/160K – CC SINGLE STAGE & N90/160K – CC TWO STAGE – WATER COOLED

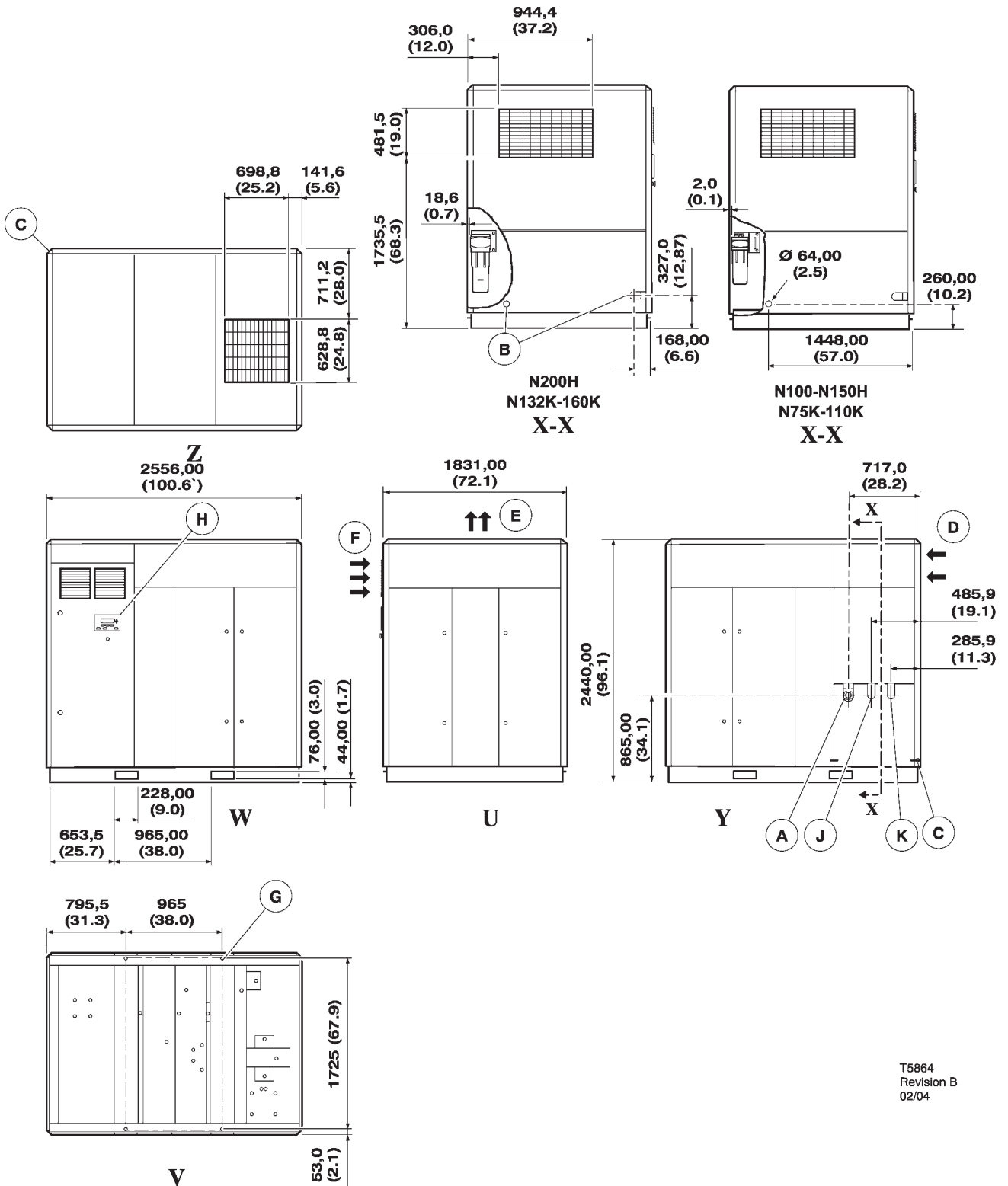

T5864
Revision B
02/04

8.0 GENERAL INFORMATION

KEY

A	2" NPT Air discharge (Female) 60Hz units (N100H–N150H) 2" BSP Air discharge (Female) 50Hz units (N75K–N110K) 2 1/2" NPT Air discharge (Female) 60Hz units (N200H) 2 1/2" BSP Air discharge (Female) 50Hz units (N132K and N160K units)	F	Cabinet cooling airflow
B	Electrical inlet – Ø75mm (3") Ø64mm 575V (Option)	G	4 x Ø 13.0mm (0,5") Compressor should be bolted to the floor with four M10 (0.38") bolts using holes shown. Seal base to floor with cork or rubber.
C	0.38" NPT (Female) Note: Pipe condensate drain lines separately to an open drain due to differences in drain pressures. Use drain lines at least as large as the connection. Read operations manual and check local regulations	H	INTELLISYS Controller
D	Cooling airflow	J	1.5" NPT Water inlet (Female) 60Hz units 1.5" BSP Water inlet (Female) 50Hz units
E	Exhaust airflow	K	1.5" NPT Water outlet (Female) 60Hz units 1.5" BSP Water outlet (Female) 50Hz units
		U	Right
		V	Bottom
		W	Front
		X–X	Section through X–X
		Y	Rear view
		Z	Plan view

8.0 GENERAL INFORMATION

8.2 INSTALLATION DRAWING – N90/160K, N125/200H SINGLE STAGE & N75/160K, N100/200H TWO STAGE – AIR COOLED

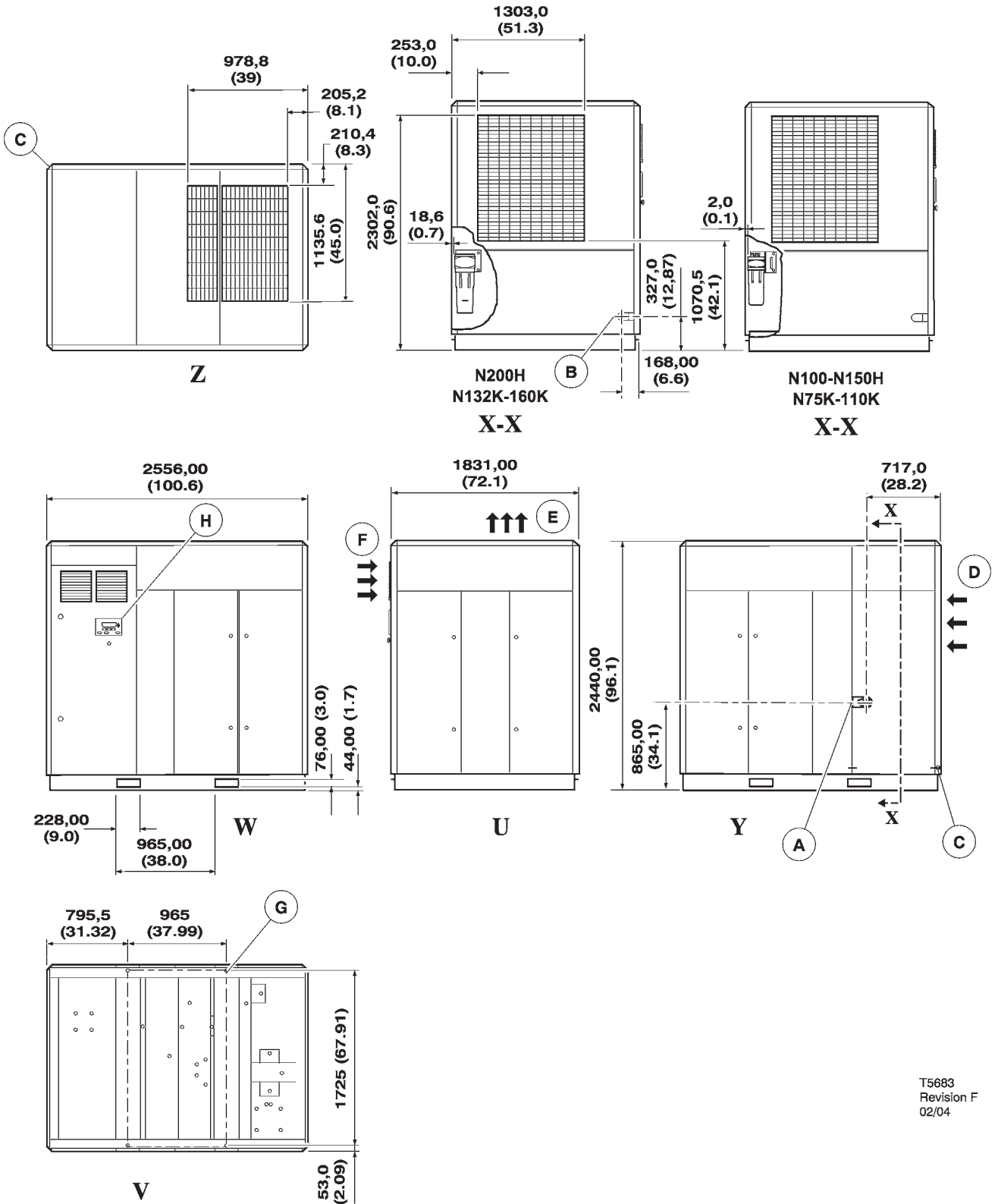

T5683
Revision F
02/04

8.0 GENERAL INFORMATION

KEY

A	2" NPT Air discharge (Female) 60Hz units (N100H–N150H) 2" BSP Air discharge (Female) 50Hz units (N75K–N110K) 2 1/2" NPT Air discharge (Female) 60Hz units (N200H) 2 1/2" BSP Air discharge (Female) 50Hz units (N132K and N160K units)	E	Exhaust airflow
B	Electrical inlet – Ø75mm (3") Ø64mm 575V (Option)	F	Cabinet cooling airflow
C	0.38" NPT (Female)	G	4 x Ø 13.0mm (0,5") Compressor should be bolted to the floor with four M10 (0.38") bolts using holes shown. Seal base to floor with cork or rubber.
Note:	Pipe condensate drain lines separately to an open drain due to differences in drain pressures. Use drain lines at least as large as the connection. Read operations manual and check local regulations	H	INTELLISYS Controller
D	Cooling airflow	U	Right
		V	Bottom
		W	Front
		X–X	Section through X–X
		Y	Rear view
		Z	Plan view

8.0 GENERAL INFORMATION

8.2 INSTALLATION DRAWING – N250/300H TWO STAGE

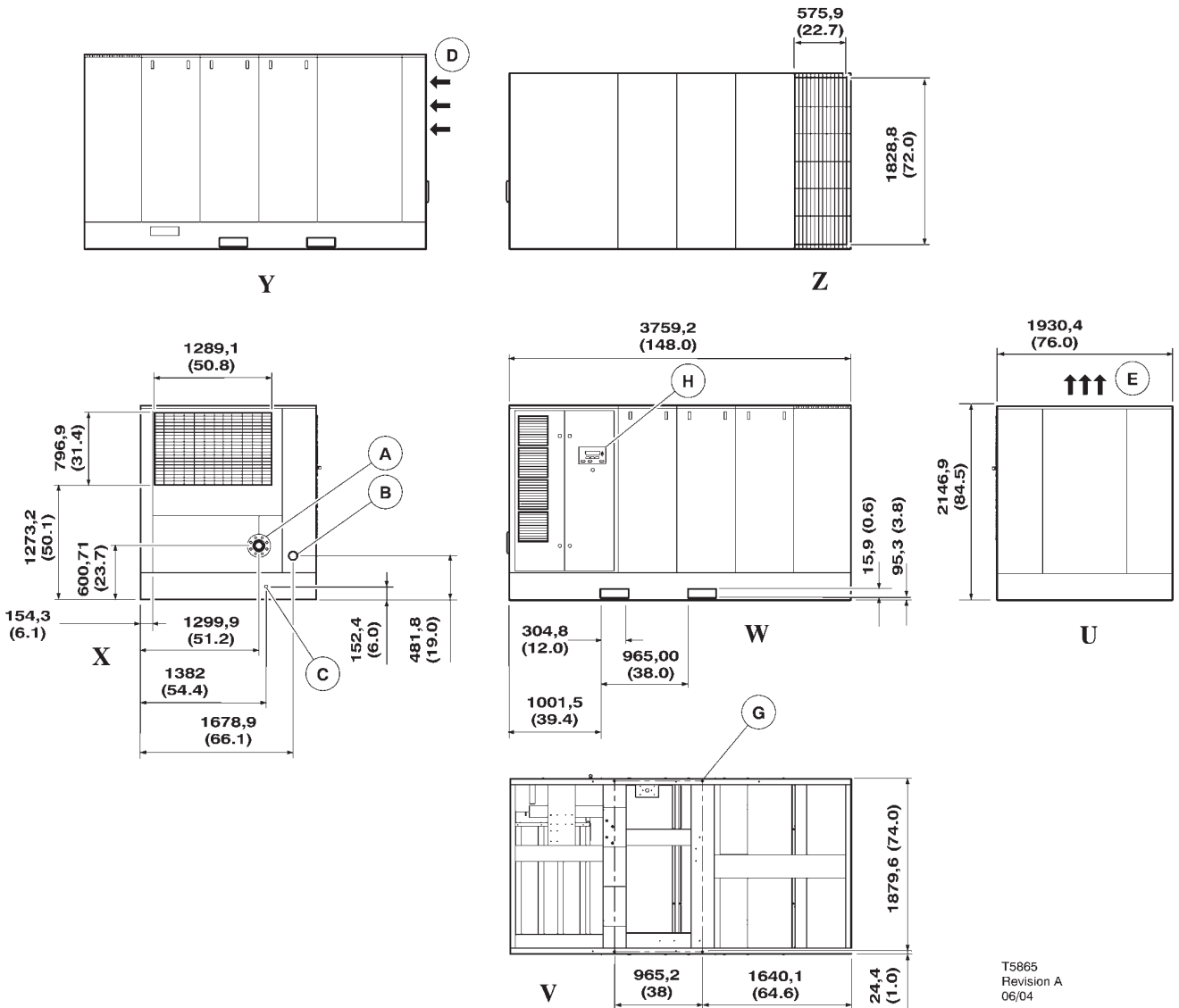

T5865
Revision A
06/04

KEY

A 4" NPT Air discharge (Female)

B Electrical inlet –
Ø75mm (3")

C 0.50" NPT (Female)

Note: Pipe condensate drain lines separately to an open drain due to differences in drain pressures. Use drain lines at least as large as the connection. Read operations manual and check local regulations

D Cooling airflow

E Exhaust airflow

F Cabinet cooling airflow

G 4 x Ø 14.2mm (0.6")

Compressor should be bolted to the floor with four M12 (0.5") bolts using holes shown. Seal base to floor with cork or rubber.

H INTELLISYS Controller

U Right

V Bottom

W Front

X Left view

Y Rear view

Z Plan view

8.0 GENERAL INFORMATION

8.3 PROCESS AND INSTRUMENTATION DIAGRAM N37/45K-CC & N50/60H-CC

22381206
Revision B

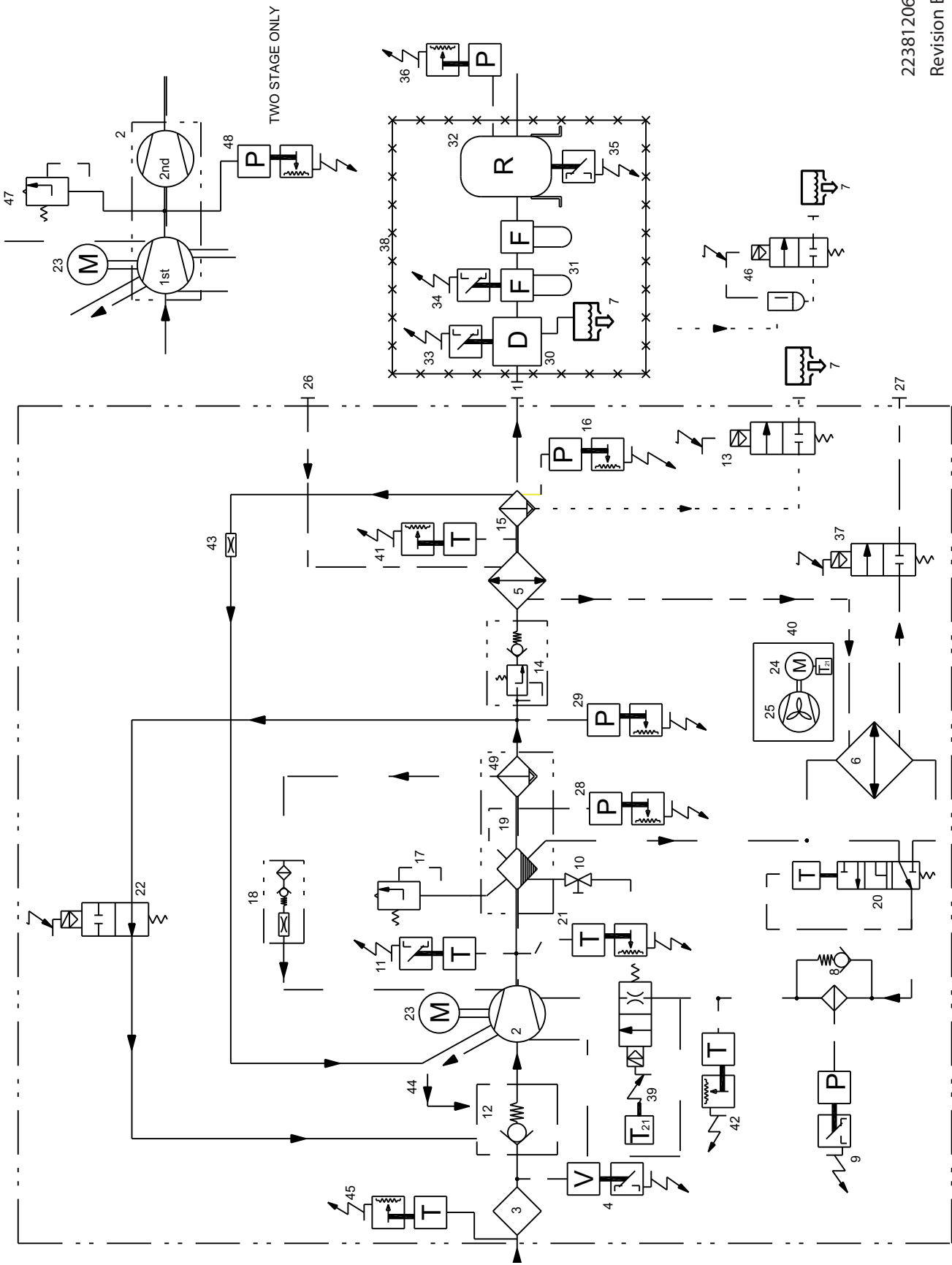

8.0 GENERAL INFORMATION

KEY

1	Air discharge	32	Receivers (customer equipment)
2	Compressor	33	Dryer AUX warning
3	Air filter	34	Line filter AUX warning
4	Vacuum switch 1VAC	35	Receiver trap AUX warning
5	Cooler, air	36	Remote pressure transducer 9APT (optional)
6	Cooler, coolant	37	Water stop valve 4SV
7	Condensate discharge	38	Typical customer downstream air treatment
8	Coolant filter	39	Anti – condensation valve 11SV
9	Pressure switch, coolant filter 1DPS	40	Cooling air exhaust box
10	Drain valve, coolant	41	Package discharge temperature transducer 4ATT
11	Temperature switch 1ATS	42	Injected coolant temperature sensor
12	Air inlet check valve	43	Seal scavenge air supply
13	Timed solenoid condensate drain. (single stage)	44	Seal scavenge line
14	Minimum pressure check valve	45	Air intake temperature sensor. 1ATT
15	Moisture separator	46	Electronic drain trap. Alternative to item 13. (Standard equipment on 2 stage. Optional on single stage).
16	Pressure transducer 4APT	45	Interstage pressure relief valve. (2 stage.)
17	Pressure relief valve	46	Interstage pressure transducer. (2 stage)
18	Scavenge filter / orifice / check	49	Air/Coolant separator element
19	Separator tank (primary/secondary)		
20	Oil temperature control valve	Air/coolant	=====
21	Temperature transducer 2ATT	Air	_____
22	3SV blowdown solenoid valve	Coolant	- - - - -
23	Drive motor	Condensate	-----
24	Blower motor	Cooling water (W.C. only)	-----
25	Cooling air blower	Compressor enclosure
26	Cooling water inlet (W.C. only)	Sensor connection	_____
27	Cooling water outlet (W.C. only)	Equipment downstream of compressor	××××××××
28	Pressure transducer 3APT		
29	Pressure transducer 6APT		
30	Dryer (customer supply equipment)		
31	Line filters (customer equipment)		

8.0 GENERAL INFORMATION

8.3 PROCESS AND INSTRUMENTATION DIAGRAM N55/75K-CC & N75/100H-CC

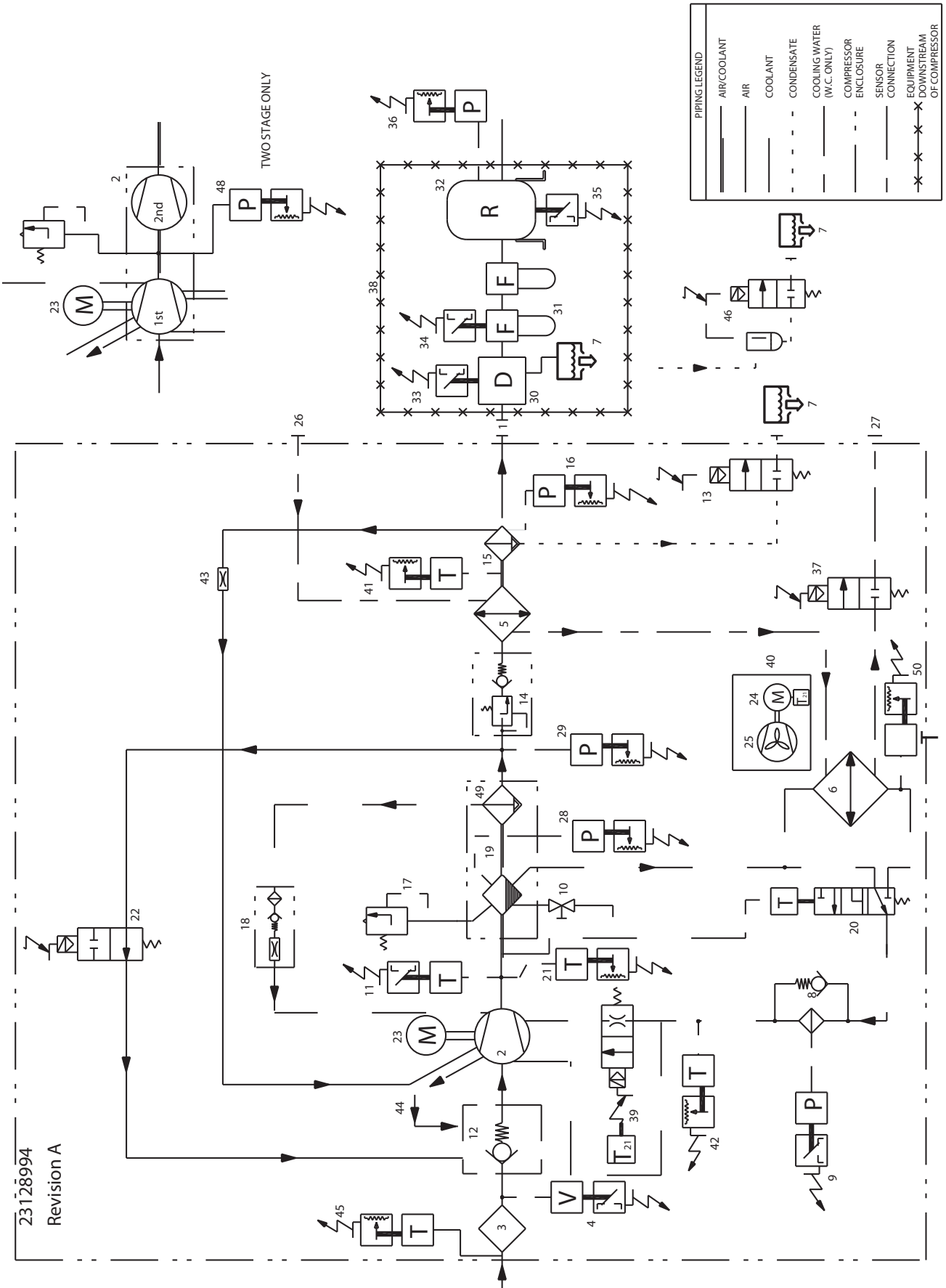

8.0 GENERAL INFORMATION

KEY

1	AIR DISCHARGE	36	REMOTE AIR PRESSURE TRANSDUCER 9APT (OPTIONAL)
2	COMPRESSOR	37	WATER SHUTOFF VALVE 4SV (W.C. ONLY)
3	AIR FILTER	38	TYPICAL CUSTOMER DOWNSTREAM AIR TREATMENT
4	VACUUM SWITCH 1VAC	39	ANTI-CONDENSATION VALVE 11SV
5	COOLER, AIR	40	COOLING AIR EXHAUST BOX
6	COOLER, COOLANT	41	PACKAGE DISCHARGE AIR TEMPERATURE SENSOR 4ATT
7	CONDENSATE DISCHARGE	42	INJECTED COOLANT TEMPERATURE SENSOR 2CTT
8	COOLANT FILTER (S)	43	ORIFICE, SEAL SCAVENGE AIR SUPPLY
9	PRESSURE SWITCH, COOLANT FILTER 1DPS	44	SEAL SCAVENGE LINE DRAIN
10	DRAIN VALVE, COOLANT	45	PACKAGE INTAKE AIR TEMPERATURE SENSOR 1ATT
11	HIGH AIR TEMPERATURE SWITCH 1ATS	46	ELECTRONIC DRAIN TRAP-ALTERNATIVE TO ITEM 13 (STANDARD EQUIPMENT ON 2 STAGE OPTIONAL ON SINGLE STAGE)
12	AIR INLET/CHECK VALVE	47	INTERSTAGE PRESSURE RELIEF VALVE (TWO STAGE)
13	TIMED SOLENOID CONDENSATE DRAIN SINGLE STAGE UNITS ONLY)	48	INTERSTAGE PRESSURE TRANSDUCER (TWO STAGE)
14	MINIMUM PRESSURE CHECK VALVE	49	AIR/COOLANT SEPARATOR ELEMENT
15	MOISTURE SEPARATOR	50	OIL COOLER OUT TEMPERATURE SENSOR 4CTT
16	PRESSURE TRANSDUCER 4APT		Air/coolant =====
17	PRESSURE RELIEF VALVE		Air -----
18	SCAVENGE FILTER / ORIFICE / CHECK VALVE		Coolant - - - - -
19	SEPARATOR TANK (PRIMARY/SECONDARY)		Condensate -----
20	OIL TEMPERATURE CONTROL VALVE		Cooling water (W.C. only) -----
21	TEMPERATURE SENSOR 2ATT		Compressor enclosure
22	BLOWDOWN SOLENOID VALVE 3SV		Sensor connection -----
23	DRIVE MOTOR - VARIABLE SPEED		Equipment downstream of compressor ×××××××
24	MOTOR, BLOWER - VARIABLE SPEED		
25	COOLING AIR BLOWER		
26	COOLING WATER INLET (W.C. ONLY)		
27	COOLING WATER OUTLET (W.C. ONLY)		
28	PRESSURE TRANSDUCER 3APT (WET)		
29	PRESSURE TRANSDUCER 6APT (DRY)		
30	DRYER (CUSTOMER EQUIPMENT)		
31	LINE FILTERS (CUSTOMER EQUIPMENT)		
32	RECEIVERS (CUSTOMER EQUIPMENT)		
33	DRYER AUX WARNING		
34	LINE FILTER AUX WARNING AW1 (WIRE IN SERIES)		
35	RECEIVER TRAP AUX WARNING		

8.0 GENERAL INFORMATION

8.3 PROCESS AND INSTRUMENTATION DIAGRAM N90/160K & N125/200H SINGLE STAGE AND N75/160K & N100/200H TWO STAGE

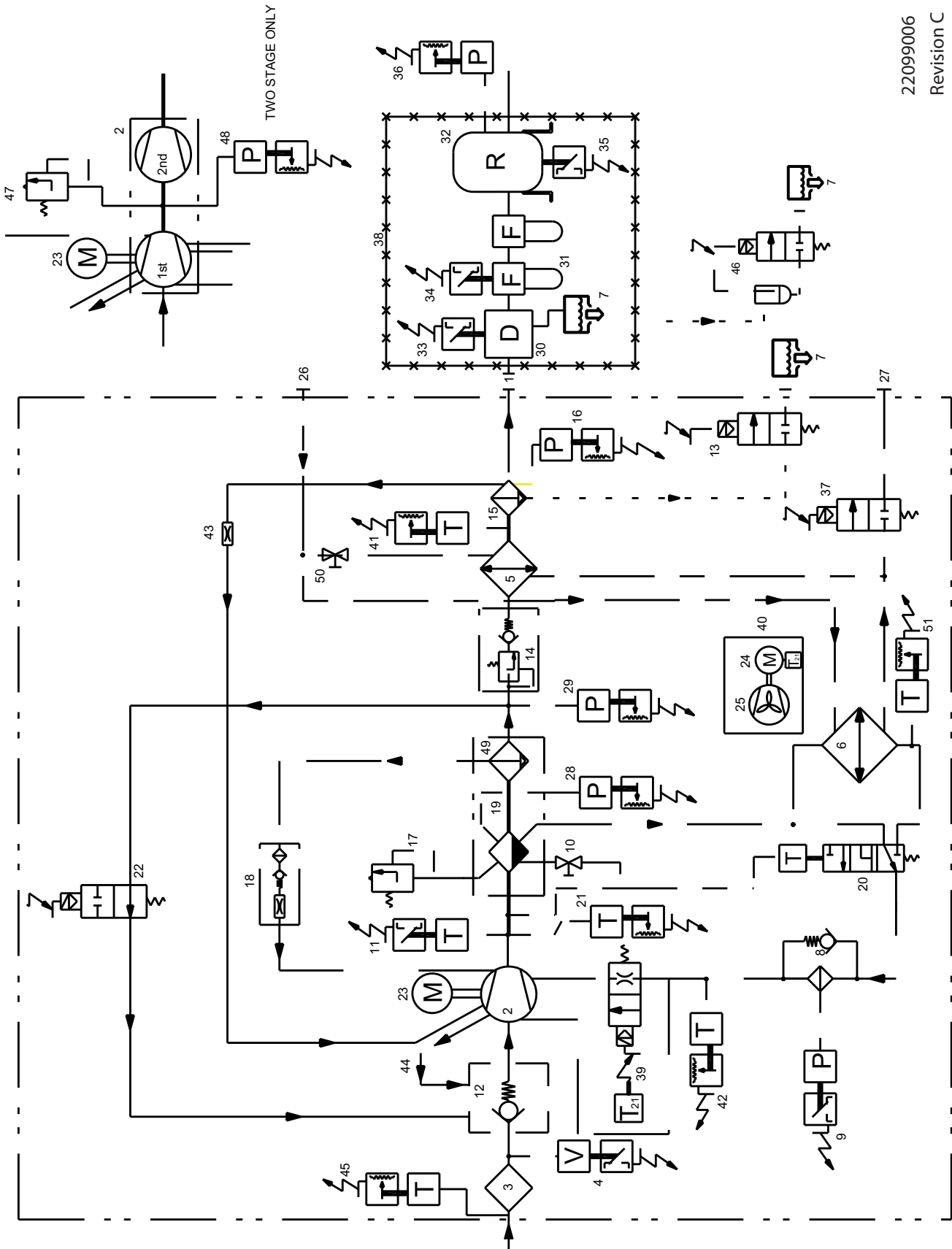

8.0 GENERAL INFORMATION

KEY

1	Air discharge	33	Dryer AUX warning
2	Compressor	34	Line filter AUX warning
3	Air filter	35	Receiver trap AUX warning
4	Vacuum switch 1VAC	36	Remote pressure transducer 9APT (optional)
5	Cooler, air	37	Water stop valve 4SV (W.C. only)
6	Cooler, coolant	38	Typical customer downstream air treatment
7	Condensate discharge	39	Anti – condensation valve 11SV
8	Coolant filter	40	Cooling air exhaust box
9	Pressure switch, coolant filter 1DPS	41	Package discharge temperature transducer 4ATT
10	Drain valve, coolant	42	Injection temperature, transducer 2CTT
11	Temperature switch 1ATS	43	Seal scavenge air supply
12	Air inlet check valve	44	Seal scavenge line
13	Timed solenoid condensate drain. (single stage only)	45	Temperature sensor 1ATT
14	Minimum pressure check valve	46	Electronic drain trap. Alternative to item 13 (Optional on single stage)
15	Moisture separator	47	Interstage pressure relief valve. 2 stage.
16	Pressure transducer 4APT	48	Interstage pressure transducer. 2 stage
17	Pressure relief valve	49	Element, separator
18	Scavenge filter / orifice / check	50	Valve, aftercooler trim (W.C. only)
19	Separator tank (primary/secondary)	51	Valve, airend discharge temperature control (W.C. only)
20	Oil temperature control valve		
21	Temperature transducer 2ATT	Air/coolant	=====
22	3SV blowdown solenoid valve	Air	=====
23	Drive motor	Coolant	- - - - -
24	Blower motor	Condensate	_____ - - - - -
25	Cooling air blower		
26	Cooling water inlet (W.C. only)	Cooling water (W.C. only)	_____ - - - - -
27	Cooling water outlet (W.C. only)	Compressor enclosure	.. _____ .. _____ .. _____
28	Pressure transducer 3APT	Sensor connection	_____ - - - - -
29	Pressure transducer 6APT	Equipment downstream of compressor	××××××××
30	Dryer (customer supply equipment)		
31	Line filters (customer equipment)		
32	Receivers (customer equipment)		

8.0 GENERAL INFORMATION

8.3 PROCESS AND INSTRUMENTATION DIAGRAM N250-300H TWO STAGE

22402135
Revision C

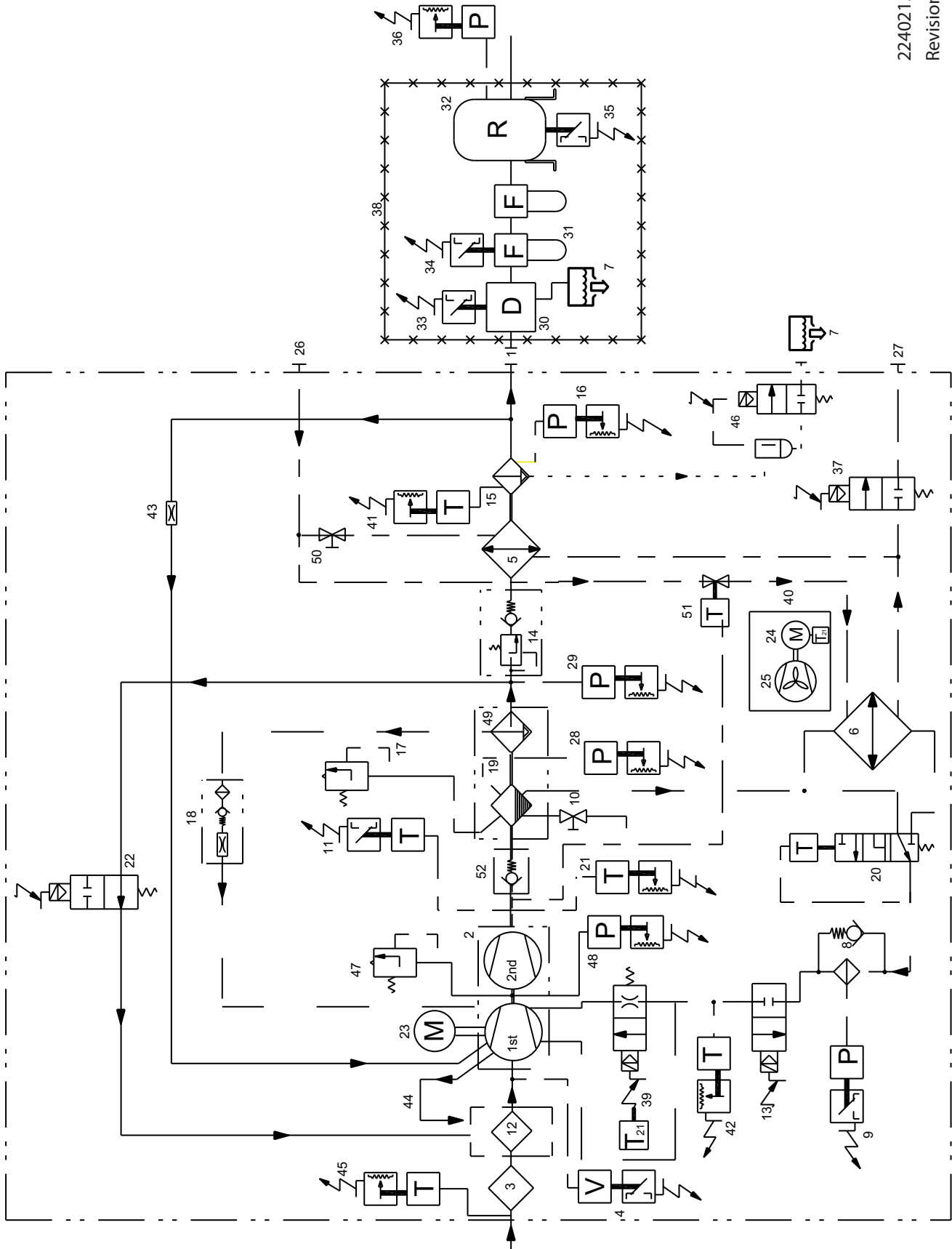

8.0 GENERAL INFORMATION

KEY

1	Air discharge	33	Dryer AUX warning
2	Compressor	34	Line filter AUX warning
3	Air filter	35	Receiver trap AUX warning
4	Vacuum switch 1VAC	36	Remote pressure transducer 9APT (optional)
5	Cooler, air	37	Water stop valve 4SV (W.C. only)
6	Cooler, coolant	38	Typical customer downstream air treatment
7	Condensate discharge	39	Anti – condensation valve 11SV
8	Coolant filter	40	Cooling air exhaust box
9	Pressure switch, coolant filter 1DPS	41	Package discharge temperature transducer 4ATT
10	Drain valve, coolant	42	Injection temperature, transducer 2CTT
11	Temperature switch 1ATS	43	Orifice, seal scavenge air supply
12	Air inlet/adaptor	44	Seal scavenge line
13	Coolant stop solenoid valve 5SV	45	Temperature sensor 1ATT
14	Minimum pressure check valve	46	Electronic drain trap
15	Moisture separator	47	Interstage pressure relief valve. 2 stage.
16	Pressure transducer 4APT	48	Interstage pressure transducer. 2 stage
17	Pressure relief valve	49	Element, separator
18	Scavenge filter / orifice / check	50	Valve, aftercooler trim (W.C. only)
19	Separator tank (primary/secondary)	51	Valve, airend discharge temperature control (W.C. only)
20	Oil temperature control valve	52	Airend discharge check valve.
21	Temperature transducer 2ATT		
22	3SV blowdown solenoid valve		PIPING LEGEND
23	Drive motor	Air/coolant	=====
24	Blower motor	Air	=====
25	Cooling air blower	Coolant	=====
26	Cooling water inlet (W.C. only)	Condensate	-----
27	Cooling water outlet (W.C. only)	Cooling water (W.C. only)	-----
28	Pressure transducer 3APT	Compressor enclosure	-----
29	Pressure transducer 6APT	Sensor connection	-----
30	Dryer (customer supply equipment)	Equipment downstream of compressor	-----X-----X-----X
31	Line filters (customer equipment)		
32	Receivers (customer equipment)		

8.0 GENERAL INFORMATION

8.4 WIRING SCHEMATIC N37K – N45K-CC / N50-60H-CC A/C BLOWER VFD

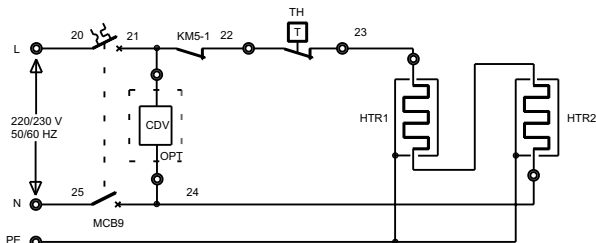
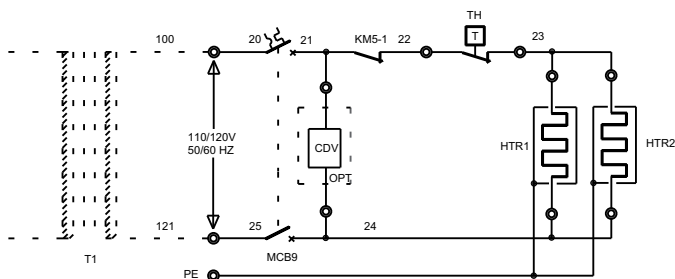
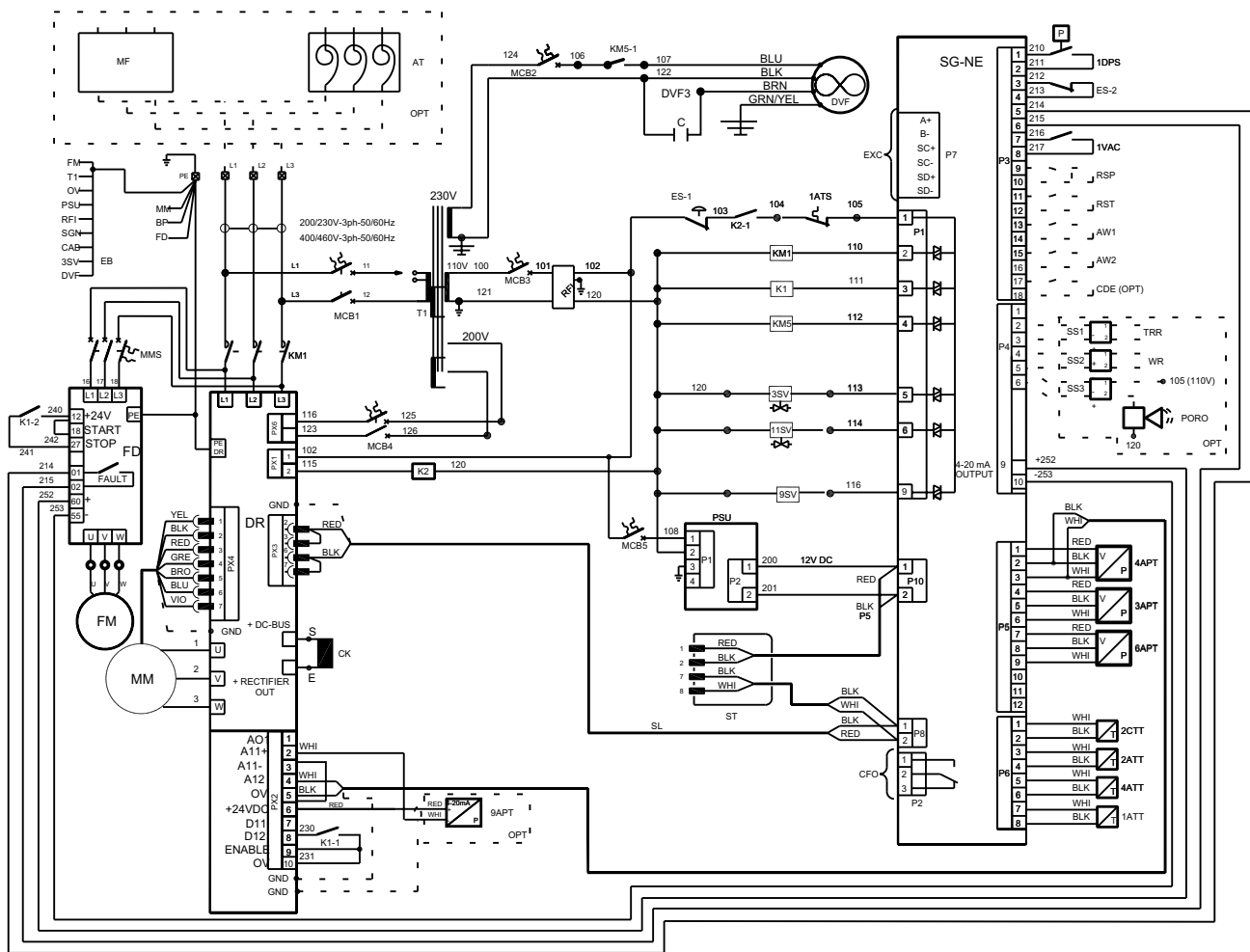

22775738
Revision B

8.0 GENERAL INFORMATION

KEY

1ATS	Switch, high airend discharge temperature	PSU	Power supply unit
1DPS	Switch, fouled oil filter	RFI	Filter, radio frequency interference
1VAC	Switch, fouled air filter	RSP	Remote stop
1ATT	Sensor, airend inlet.	RST	Remote start
2ATT	Sensor, airend discharge temperature	SGNE	Controller, Intellisys
2CTT	Sensor, injected coolant temperature	SL	Serial link
3APT	Transducer, sump pressure, wet side	SS1-3	Relay, solid state
3SV	Valve, blowdown solenoid	ST	Service tool
4APT	Transducer, package air discharge pressure	T1	Transformer, control
4ATT	Sensor, package discharge temperature	TH	Thermostat
4SV	Valve, water stop solenoid (W/C only)	TRR	True running relay
6APT	Transducer, sump air pressure, dry side	WR	General warning
9APT	Transmitter, remote air pressure (optional)		Colors
9SV	Valve, condensate drain	BLK	Black
11SV	Valve, anti – condensation solenoid	BLU	Blue
AT	Autotransformer (if fitted)	BRO	Brown
AW1	Auxiliary warning 1	GRE	Green
AW2	Auxiliary warning 2	PIN	Pink
BP	Backplate	RED	Red
C	Capacitor	SCR	Screened
CAB	Cabinet	VIO	Violet
CDE	Condensate drain error	WHI	White
CDV	Condensate drain valve. (if fitted)	YEL	Yellow
CFO	Common fault output		
CK	Choke		
EXC	External communications		
DR	Drive		
DVF	Fan, drive box ventilation		
EB	Earth bar		
ES	Switch, emergency stop		
FD	Drive, blower		
FM	Motor, blower		
GND	Ground		
HC	Heater circuit		
HTR1	Heater, spacer 25 Watts		
HTR2	Heater, spacer 25 Watts		
K1	Relay, run		
K2	Relay fault		
KM1	Contact, main motor		
KM5	Contact, Drive ventilation fan.		
MCB1	Breaker, miniature circuit, transformer		
MCB2	Breaker, miniature circuit, DVFMCB3		
MCB3	Breaker, miniature circuit, control circuits		
MCB4	Breaker, miniature circuit, VFD supply		
MCB5	Breaker, miniature circuit, PSU		
MCB9	Breaker, miniature circuit, heater		
MF	Mains filter (if fitted)		
MM	Motor, main		
MMS	Breaker, blower motor		
OPT	Optional		
OV	Zero voltage		
PE	Protected earth		
PORO	Power outage restart option (optional)		

Wires

Numbers	Function	Wire color
1-99	Power	Black
100-199	AC Control	Red
200-299	DC Control	Blue
300-399	Auxiliary	Orange

8.0 GENERAL INFORMATION

8.4 WIRING SCHEMATIC - N55-75K-CC / N75-100H-CC A/C BLOWER VFD

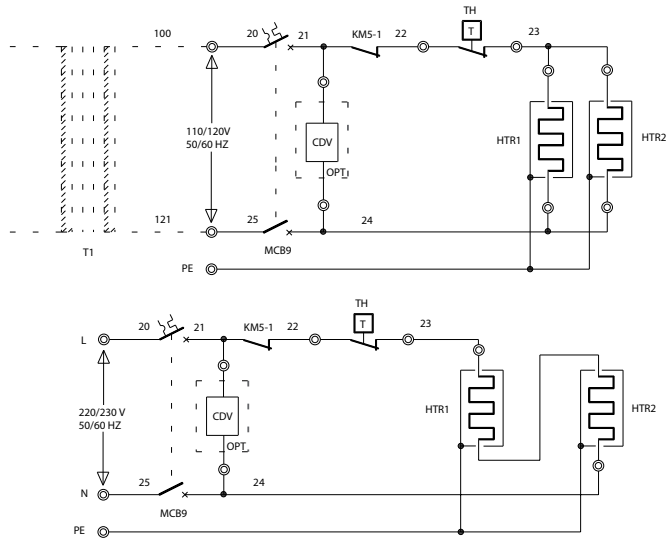
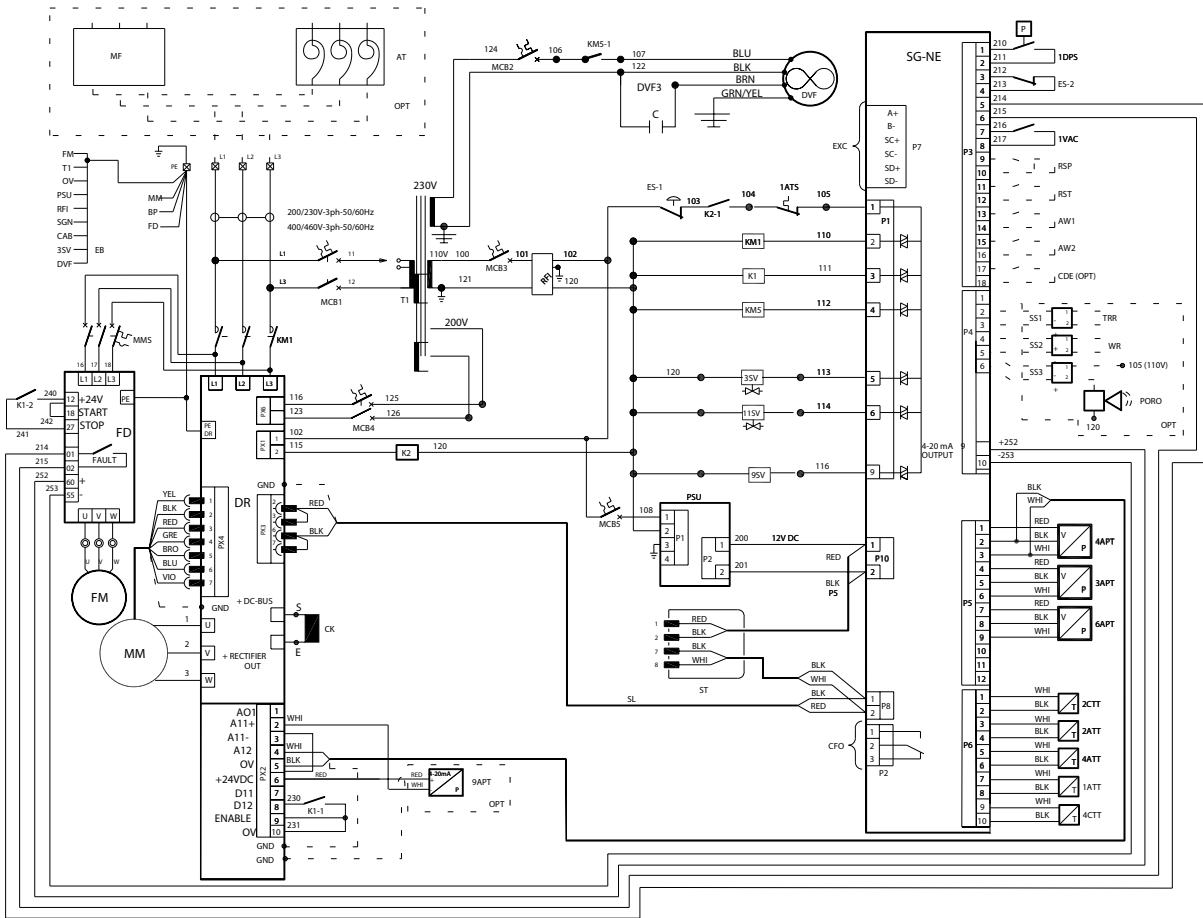

23131337
Revision A

LABEL DESCRIPTION

- 1ATS SWITCH, HIGH AIR END DISCHARGE TEMPERATURE
- 1DPS SWITCH, FOULED OIL FILTER
- 1VAC SWITCH, FOULED AIR FILTER
- 1ATT SENSOR, AIREND INLET
- 2ATT SENSOR, AIREND DISCHARGE TEMPERATURE
- 2CTT SENSOR, INJECTED COOLENT TEMPERATURE

LABEL DESCRIPTION

- 3APT TRANSDUCER, SUMP PRESSURE, WET SIDE
- 3SV VALVE, BLOWDOWN SOLENOID
- 4APT TRANSDUCER, PACKAGE AIR DISCHARGE PRESSURE
- 4ATT SENSOR, PACKAGE AIR DISCHARGE TEMPERATURE
- 4CTT SENSOR, OIL COOLER OUT TEMPERATURE

8.0 GENERAL INFORMATION

KEY

4SV	VALVE, WATER STOP SOLENOID (W/C ONLY)
6APT	TRANSDUCER, SUMP AIR PRESSURE, DRY SIDE
9APT	TRANSMITTER, REMOTE AIR PRESSURE (OPTIONAL)
9SV	VALVE, CONDENSATE DRAIN
11SV	VALVE, ANTI-CONDENSATION SOLENOID
AT	AUTOTRANSFORMER (IF FITTED)
AW1	AUXILIARY WARNING 1
AW2	AUXILIARY WARNING 2
BP	BACKPLATE
C	CAPACITOR
CAB	CABINET
CDE	CONDENSATE DRAIN ERROR
CDV	CONDENSATE DRAIN VALVE (IF FITTED)
CFO	COMMON FAULT OUTPUT
CK	CHOKE
EXC	EXTERNAL COMMUNICATIONS
DR	DRIVE
DVF	FAN, DRIVE BOX VENTILATION
EB	EARTH BAR
ES	SWITCH, EMERGENCY STOP
FD	DRIVE, BLOWER
FM	MOTOR, BLOWER
GND	GROUND
HTR1	HEATER, SPACER 25 WATTS
HTR2	HEATER, SPACER 25 WATTS
K1	RELAY, RUN
K2	RELAY, FAULT
KM1	CONTACTOR, MAIN MOTOR
KM5	CONTACTOR, DRIVE VENTILATION FAN
MCB1	BREAKER, MINIATURE CIRCUIT, TRANSFORMER
MCB2	BREAKER, MINIATURE CIRCUIT, DVF
MCB3	BREAKER, MINIATURE CIRCUIT, CONTROL CIRCUITS
MCB4	BREAKER, MINIATURE CIRCUIT, VFD SUPPLY
MCB5	BREAKER, MINIATURE CIRCUIT, PSU
MCB9	BREAKER, MINIATURE CIRCUIT, HEATERS
MF	MAINS FILTER (IF FITTED)
MM	MOTOR, MAIN
MMS	BREAKER, FAN MOTOR
OPT	OPTIONAL
OV	ZERO VOLTAGE
PE	PROTECTED EARTH
PORO	POWER OUTAGE RESTART OPTION (OPTIONAL)
PSU	POWER SUPPLY UNIT
RFI	FILTER, RADIO FREQUENCY INTERFERENCE
RSP	REMOTE STOP
RST	REMOTE START
SGNE	CONTROLLER, INTELLISYS
SL	SERIAL LINK
SS1-3	RELAY, SOLID STATE
ST	SERVICE TOOL

T1	TRANSFORMER, CONTROL
TH	THERMOSTAT
TRR	TRUE RUNNING
WR	GENERAL WARNING

COLORS

BLK	BLACK
BLU	BLUE
BRO	BROWN
GRE	GREEN
PIN	PINK
RED	RED
SCR	SCREEN
VIO	VIOLET
WHI	WHITE
YEL	YELLOW

Wires

Numbers	Function	Wire color
1-99	Power	Black
100-199	AC Control	Red
200-299	DC Control	Blue
300-399	Auxiliary	Orange

NOTES:

1. FACTORY SUPPLIED AS SHOWN BY CONNECTION TO OUTPUT OF CONTROL TRANSFORMER T1. WIRE NUMBER 100 & 121.
2. ALTERNATIVELY THE SUPPLY MAY BE TAKEN FROM AN INDEPENDENT SOURCE: IN THAT CASE, FACTORY SUPPLIED CONNECTION MUST BE DISCONNECTED.
3. ENSURE PARALLEL CONNECTION OF HEATERS.

NOTES:

1. CONNECTIONS FOR USE ON 200/230V SYSTEMS. THE SUPPLY IS INDEPENDENT OF THE MAIN COMPRESSOR. THE CUSTOMER MUST PROVIDE AN ISOLATOR / DISCONNECT SWITCH ADJACENT TO THE MACHINE FOR THIS SUPPLY. IN THAT CASE, FACTORY SUPPLIED CONNECTION MUST BE DISCONNECTED.
2. ENSURE SERIES CONNECTION OF HEATERS.

8.0 GENERAL INFORMATION

8.4 WIRING SCHEMATIC - N37/45K-CC/N50/60H-CC W/C

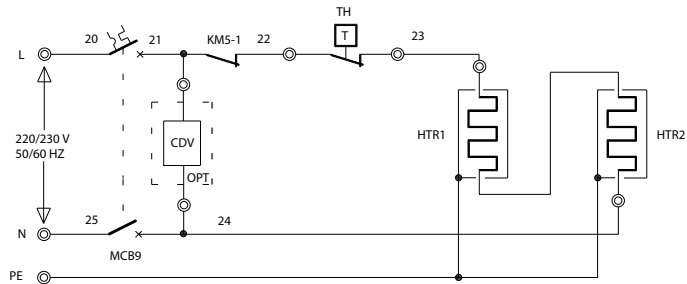
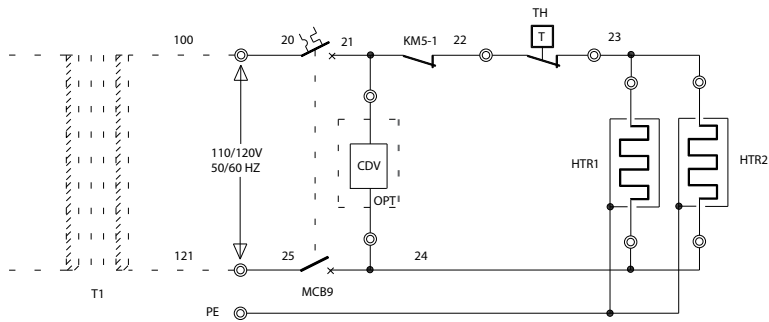
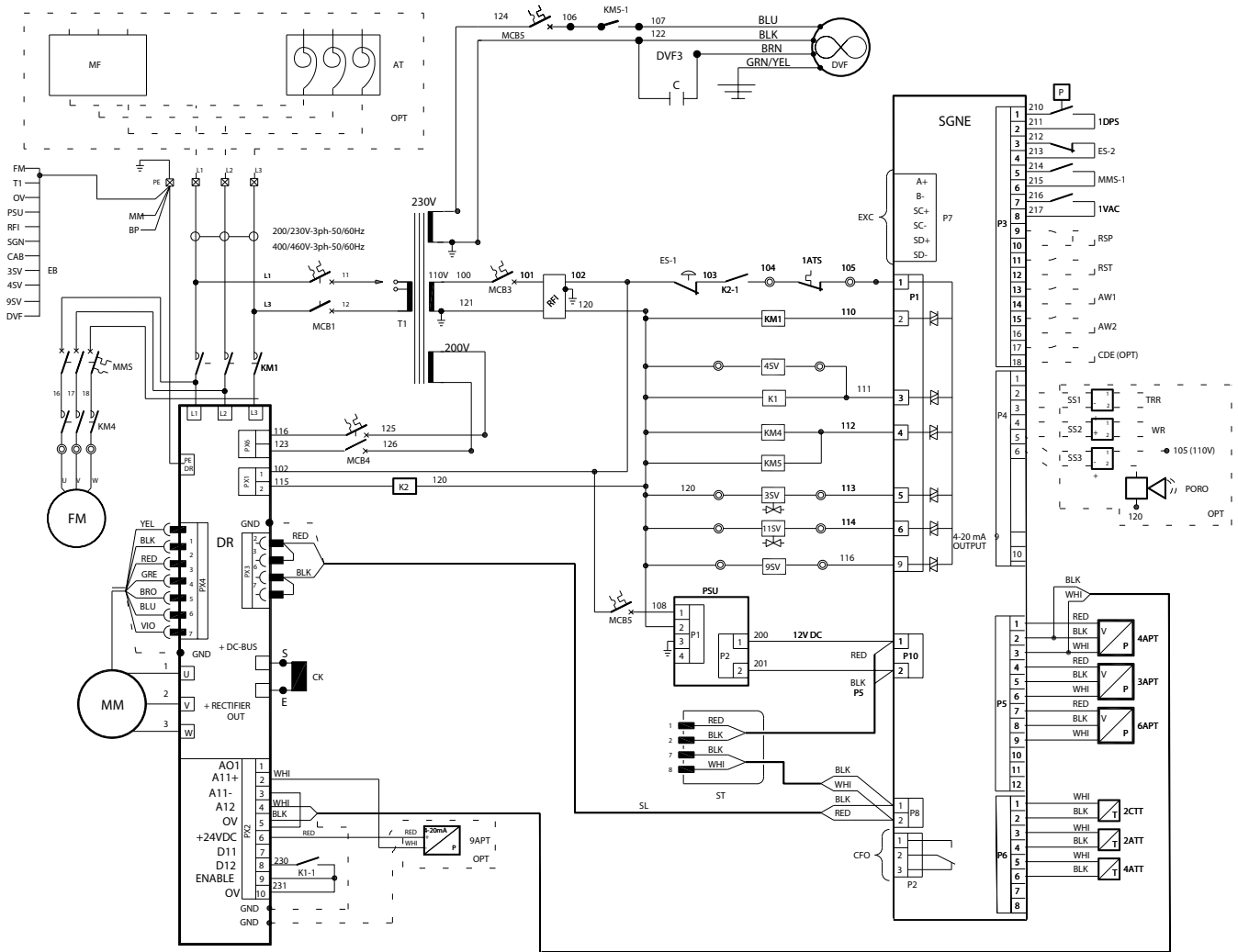

22776520
Revision B

8.0 GENERAL INFORMATION

KEY

1ATS	SWITCH, HIGH AIR END DISCHARGE TEMPERATURE
1DPS	SWITCH, FOULED OIL FILTER
1VAC	SWITCH, FOULED AIR FILTER
1ATT	SENSOR, AIREND INLET
2ATT	SENSOR, AIREND DISCHARGE TEMPERATURE
2CTT	SENSOR, INJECTED COOLENT TEMPERATURE
3APT	TRANSDUCER, SUMP PRESSURE, WET SIDE
3SV	VALVE, BLOWDOWN SOLENOID
4APT	TRANSDUCER, PACKAGE AIR DISCHARGE PRESSURE
4ATT	SENSOR, PACKAGE AIR DISCHARGE TEMPERATURE
4SV	VALVE, WATER STOP SOLENOID (W/C ONLY)
6APT	TRANSDUCER, SUMP AIR PRESSURE, DRY SIDE
9APT	TRANSMITTER, REMOTE AIR PRESSURE (OPTIONAL)
9SV	VALVE, CONDENSATE DRAIN
11SV	VALVE, ANTI-CONDENSATION SOLENOID
AT	AUTOTRANSFORMER (IF FITTED)
AW1	AUXILIARY WARNING 1
AW2	AUXILIARY WARNING 2
BP	BACKPLATE
C	CAPACITOR
CAB	CABINET
CDE	CONDENSATE DRAIN ERROR
CDV	CONDENSATE DRAIN VALVE (IF FITTED)
CFO	COMMON FAULT OUTPUT
CK	CHOKE
EXC	EXTERNAL COMMUNICATIONS
DR	DRIVE
DVF	FAN, DRIVE BOX VENTILATION
EB	EARTH BAR
ES	SWITCH, EMERGENCY STOP
FD	DRIVE, BLOWER (A/C ONLY)
FM	MOTOR, BLOWER
GND	GROUND
HTR1	HEATER, SPACER 25 WATTS
HTR2	HEATER, SPACER 25 WATTS
K1	RELAY, RUN
K2	RELAY, FAULT
KM1	CONTACTOR, MAIN MOTOR
KM4	CONTACTOR, FAN MOTOR (W/C ONLY)
KM5	CONTACTOR, DRIVE VENTILATION FAN
MCB1	BREAKER, MINIATURE CIRCUIT, TRANSFORMER
MCB2	BREAKER, MINIATURE CIRCUIT, DVF
MCB3	BREAKER, MINIATURE CIRCUIT, VFD SUPPLY
MCB4	BREAKER, MINIATURE CIRCUIT, VFD SUPPLY
MCB5	BREAKER, MINIATURE CIRCUIT, PSU
MCB9	BREAKER, MINIATURE CIRCUIT, HEATERS
MF	MAINS FILTER (IF FITTED)
MM	MOTOR, MAIN

MMS	BREAKER, FAN MOTOR
OPT	OPTIONAL
OV	ZERO VOLTAGE
PE	PROTECTED EARTH
PORO	POWER OUTAGE RESTART OPTION (OPTIONAL)
PSU	POWER SUPPLY UNIT
RFI	FILTER, RADIO FREQUENCY INTERFERENCE
RSP	REMOTE STOP
RST	REMOTE START
SGNE	CONTROLLER, INTELLISYS
SL	SERIAL LINK
SS1-3	RELAY, SOLID STATE
ST	SERVICE TOOL
T1	TRANSFORMER, CONTROL
TH	THERMOSTAT
TRR	TRUE RUNNING
WR	GENERAL WARNING

COLOR

BLK	BLACK
BLU	BLUE
BRO	BROWN
GRE	GREEN
PIN	PINK
RED	RED
SCR	SCREEN
VIO	VIOLET
WHI	WHITE
YEL	YELLOW

Wires

Numbers	Function	Wire color
1-99	Power	Black
100-199	AC Control	Red
200-299	DC Control	Blue
300-399	Auxiliary	Orange

NOTES:

1. FACTORY SUPPLIED AS SHOWN BY CONNECTION TO OUTPUT OF CONTROL TRANSFORMER T1. WIRE NUMBER 100 & 121.
2. ALTERNATIVELY THE SUPPLY MAY BE TAKEN FROM AN INDEPENDENT SOURCE: IN THAT CASE, FACTORY SUPPLIED CONNECTION MUST BE DISCONNECTED.
3. ENSURE PARALLEL CONNECTION OF HEATERS.

NOTES:

1. CONNECTIONS FOR USE ON 200/230V SYSTEMS. THE SUPPLY IS INDEPENDENT OF THE MAIN COMPRESSOR. THE CUSTOMER MUST PROVIDE AN ISOLATOR / DISCONNECT SWITCH ADJACENT TO THE MACHINE FOR THIS SUPPLY. IN THAT CASE, FACTORY SUPPLIED CONNECTION MUST BE DISCONNECTED.
2. ENSURE SERIES CONNECTION OF HEATERS.

8.0 GENERAL INFORMATION

8.4 WIRING SCHEMATIC - N55-75K-CC / N75-100H-CC W/C

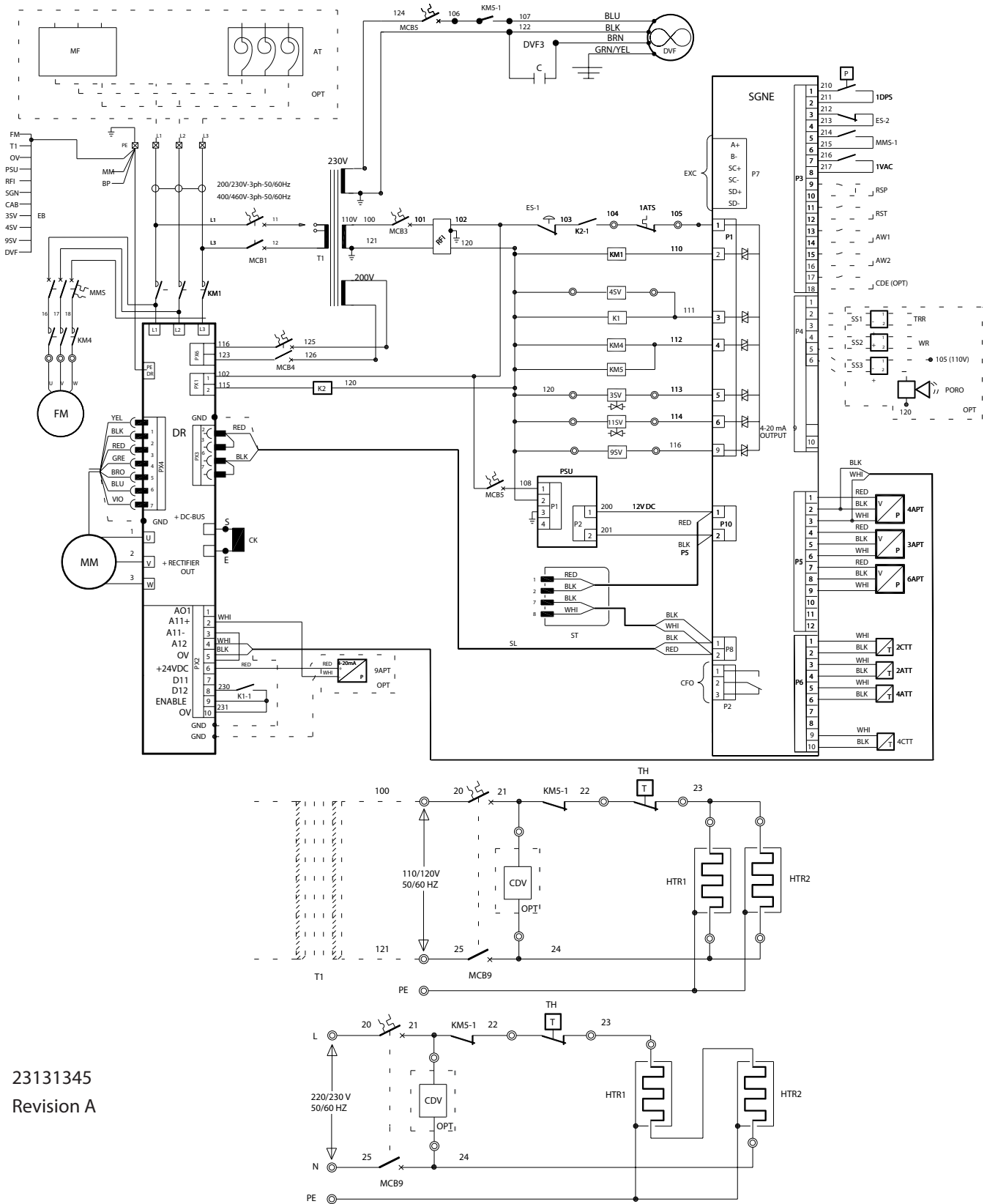

8.0 GENERAL INFORMATION

KEY

1ATS	SWITCH, HIGH AIR END DISCHARGE TEMPERATURE	MM	MOTOR, MAIN
1DPS	SWITCH, FOULED OIL FILTER	MMS	BREAKER, FAN MOTOR
1VAC	SWITCH, FOULED AIR FILTER	OPT	OPTIONAL
1ATT	SENSOR, AIREND INLET	OV	ZERO VOLTAGE
2ATT	SENSOR, AIREND DISCHARGE TEMPERATURE	PE	PROTECTED EARTH
2CTT	SENSOR, INJECTED COOLENT TEMPERATURE	PORO	POWER OUTAGE RESTART OPTION (OPTIONAL)
3APT	TRANSDUCER, SUMP PRESSURE, WET SIDE	PSU	POWER SUPPLY UNIT
3SV	VALVE, BLOWDOWN SOLENOID	RFI	FILTER, RADIO FREQUENCY INTERFERENCE
4APT	TRANSDUCER, PACKAGE AIR DISCHARGE PRESSURE	RSP	REMOTE STOP
4ATT	SENSOR, PACKAGE AIR DISCHARGE TEMPERATURE	RST	REMOTE START
4CTT	SENSOR, OIL COOLER OUT TEMPERATURE	SGNE	CONTROLLER, INTELLISYS
4SV	VALVE, WATER STOP SOLENOID (W/C ONLY)	SL	SERIAL LINK
6APT	TRANSDUCER, SUMP AIR PRESSURE, DRY SIDE	SS1-3	RELAY, SOLID STATE
9APT	TRANSMITTER, REMOTE AIR PRESSURE (OPTIONAL)	ST	SERVICE TOOL
9SV	VALVE, CONDENSATE DRAIN	T1	TRANSFORMER, CONTROL
11SV	VALVE, ANTI-CONDENSATION SOLENOID	TH	THERMOSTAT
AT	AUTOTRANSFORMER (IF FITTED)	TRR	TRUE RUNNING
AW1	AUXILIARY WARNING 1	WR	GENERAL WARNING
AW2	AUXILIARY WARNING 2		
BP	BACKPLATE		
C	CAPACITOR		
CAB	CABINET		
CDE	CONDENSATE DRAIN ERROR		
CDV	CONDENSATE DRAIN VALVE (IF FITTED)		
CFO	COMMON FAULT OUTPUT		
CK	CHOKE		
EXC	EXTERNAL COMMUNICATIONS		
DR	DRIVE		
DVF	FAN, DRIVE BOX VENTILATION		
EB	EARTH BAR		
ES	SWITCH, EMERGENCY STOP		
FD	DRIVE, BLOWER (A/C ONLY)		
FM	MOTOR, BLOWER		
GND	GROUND		
HTR1	HEATER, SPACER 25 WATTS		
HTR2	HEATER, SPACER 25 WATTS		
K1	RELAY, RUN		
K2	RELAY, FAULT		
KM1	CONTACTOR, MAIN MOTOR		
KM4	CONTACTOR, FAN MOTOR (W/C ONLY)		
KM5	CONTACTOR, DRIVE VENTILATION FAN		
MCB1	BREAKER, MINIATURE CIRCUIT, TRANSFORMER		
MCB2	BREAKER, MINIATURE CIRCUIT, DVF		
MCB3	BREAKER, MINIATURE CIRCUIT, VFD SUPPLY		
MCB4	BREAKER, MINIATURE CIRCUIT, VFD SUPPLY		
MCB5	BREAKER, MINIATURE CIRCUIT, PSU		
MCB9	BREAKER, MINIATURE CIRCUIT, HEATERS		
MF	MAINS FILTER (IF FITTED)		

COLOR

BLK	BLACK
BLU	BLUE
BRO	BROWN
GRE	GREEN
PIN	PINK
RED	RED
SCR	SCREEN
VIO	VIOLET
WHI	WHITE
YEL	YELLOW

Wires

Numbers	Function	Wire color
1-99	Power	Black
100-199	AC Control	Red
200-299	DC Control	Blue
300-399	Auxiliary	Orange

NOTES:

1. FACTORY SUPPLIED AS SHOWN BY CONNECTION TO OUTPUT OF CONTROL TRANSFORMER T1. WIRE NUMBER 100 & 121.
2. ALTERNATIVELY THE SUPPLY MAY BE TAKEN FROM AN INDEPENDENT SOURCE: IN THAT CASE, FACTORY SUPPLIED CONNECTION MUST BE DISCONNECTED.
3. ENSURE PARALLEL CONNECTION OF HEATERS.

NOTES:

1. CONNECTIONS FOR USE ON 200/230V SYSTEMS. THE SUPPLY IS INDEPENDENT OF THE MAIN COMPRESSOR. THE CUSTOMER MUST PROVIDE AN ISOLATOR / DISCONNECT SWITCH ADJACENT TO THE MACHINE FOR THIS SUPPLY. IN THAT CASE, FACTORY SUPPLIED CONNECTION MUST BE DISCONNECTED.
2. ENSURE SERIES CONNECTION OF HEATERS.

8.0 GENERAL INFORMATION

8.4 WIRING SCHEMATIC - N75-160K-CC / N125-200H-CC A/C

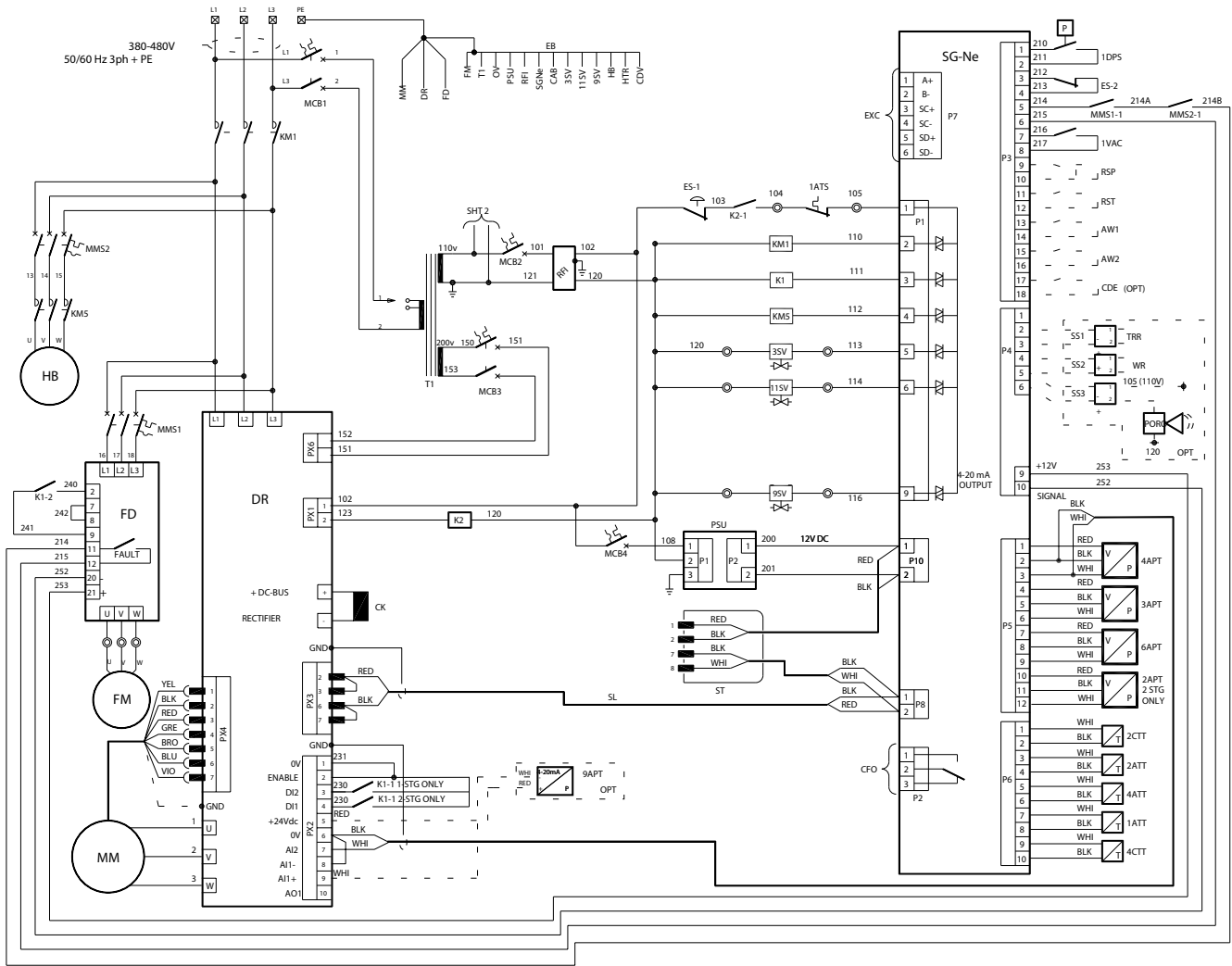

HEATER CIRCUITS:-

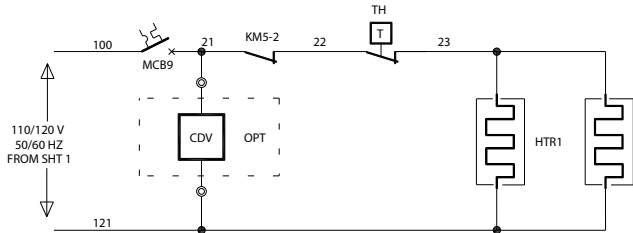

STANDARD HEATER CONNECTIONS AS DELIVERED

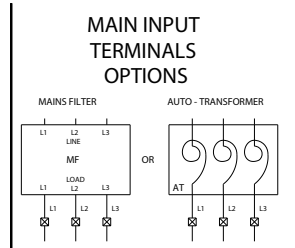

MAIN INPUT TERMINALS OPTIONS

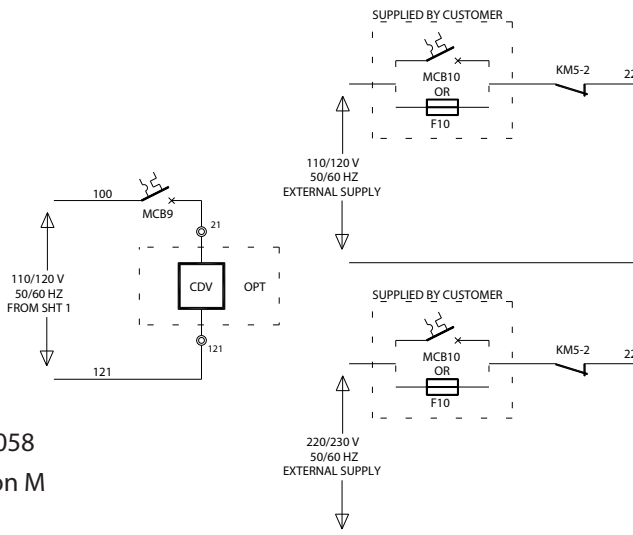

ALTERNATIVE HEATER CONNECTION FOR EXTERNAL 110 / 120 V SUPPLY

ALTERNATIVE HEATER CONNECTION FOR EXTERNAL 220 / 230 V SUPPLY

22093058
Revision M

8.0 GENERAL INFORMATION

KEY

1ATS	SWITCH, HIGH AIR END DISCHARGE TEMPERATURE	MM	MOTOR, MAIN
1ATT	SENSOR, INLET TEMPERATURE	MMS1	BREAKER, FAN MOTOR
1DPS	SWITCH, FOULED OIL FILTER	MMS2	BREAKER, HEATSINK BLOWER
1VAC	SWITCH, FOULED AIR FILTER	OPT	OPTIONAL
2APT	SENSOR, INTERSTAGE PRESSURE (2STG ONLY)	OV	ZERO VOLTAGE
2ATT	SENSOR, AIREND DISCHARGE TEMPERATURE	PE	PROTECTIVE EARTH
2CTT	SENSOR, INJECTED COOLENT TEMPERATURE	PORO	POWER OUTAGE RESTART OPTION (OPTIONAL)
3APT	TRANSDUCER, SUMP PRESSURE, WET SIDE	PSU	POWER SUPPLY UNIT
3SV	VALVE, BLOWDOWN SOLENOID	RFI	FILTER, RADIO FREQUENCY INTERFERENCE
4APT	TRANSDUCER, PACKAGE AIR DISCHARGE PRESSURE	RSP	REMOTE STOP
4ATT	SENSOR, PACKAGE AIR DISCHARGE TEMPERATURE	RST	REMOTE START
4CTT	SENSOR, OIL COOLER OUT TEMPERATURE	SGNe	CONTROLLER, INTELLISYS
6APT	TRANSDUCER, SUMP AIR PRESSURE, DRY SIDE	SL	SERIAL LINK
9APT	TRANSDUCER, REMOTE AIR PRESSURE (OPTIONAL)	SS1-3	RELAY, SOLID STATE
9SV	VALVE, CONDENSATE DRAIN	ST	SERVICE TOOL
11SV	VALVE, ANTI-CONDENSATION SOLENOID 1	T1	TRANSFORMER, CONTROL
AT	AUTOTRANSFORMER (IF FITTED)	TH	THERMOSTAT
AW1	AUXILIARY WARNING 1	TRR	TRUE RUNNING
AW2	AUXILIARY WARNING 2		
BP	BACKPLATE		
C	CAPACITOR		
CAB	CABINET		
CDE	CONDENSATE DRAIN ERROR (OPTIONAL)		
CDV	CONDENSATE DRAIN VALVE (IF FITTED)		
CFO	COMMON FAULT OUTPUT		
CK	CHOKE		
DR	DRIVE		
EB	EARTH BAR		
ES	SWITCH, EMERGENCY STOP		
EXC	EXTERNAL COMMUNICATIONS		
F10	FUSE, EXTERNAL HEATER SUPPLY		
FD	FAN DRIVE		
FM	MOTOR, BLOWER		
GND	GROUND		
HB	HEATSINK BLOWER		
HTR1	HEATER, 125 WATTS		
K1	RELAY, RUN		
K2	RELAY, FAULT		
KM1	CONTACTOR, MAIN MOTOR		
KM5	CONTACTOR, HEATSINK BLOWER		
MCB1	BREAKER, MINIATURE CIRCUIT, TRANSFORMER		
MCB2	BREAKER, MINIATURE CIRCUIT, CONTROL CIRCUITS		
MCB3	BREAKER, MINIATURE CIRCUIT, DR		
MCB4	BREAKER, MINIATURE CIRCUIT, PSU		
MCB9	BREAKER, MINIATURE CIRCUIT, HEATER		
MCB10	BREAKER, MINIATURE CIRCUIT, HEATER (EXTERNAL)		
MF	MAINS FILTER (IF FITTED)		

COLOR

BLK	BLACK
BLU	BLUE
BRO	BROWN
GRE	GREEN
PIN	PINK
RED	RED
SCR	SCREEN
VIO	VIOLET
WHI	WHITE
YEL	YELLOW

Wires

Numbers	Function	Wire color
1-99	Power	Black
100-199	AC Control	Red
200-299	DC Control	Blue
300-399	Auxiliary	Orange

NOTES:

1. FACTORY SUPPLIED AS SHOWN BY CONNECTION TO OUTPUT OF CONTROL TRANSFORMER T1. WIRE NUMBER 100 & 121.
2. ALTERNATIVELY THE SUPPLY MAY BE TAKEN FROM AN INDEPENDENT SOURCE: IN THAT CASE, FACTORY SUPPLIED CONNECTION MUST BE DISCONNECTED.
3. ENSURE PARALLEL CONNECTION OF HEATERS.

NOTES:

1. CONNECTIONS FOR USE ON 200/230V SYSTEMS. THE SUPPLY IS INDEPENDENT OF THE MAIN COMPRESSOR. THE CUSTOMER MUST PROVIDE AN ISOLATOR / DISCONNECT SWITCH ADJACENT TO THE MACHINE FOR THIS SUPPLY. IN THAT CASE, FACTORY SUPPLIED CONNECTION MUST BE DISCONNECTED.
2. ENSURE SERIES CONNECTION OF HEATERS.

8.0 GENERAL INFORMATION

8.4 WIRING SCHEMATIC - N75-160K-CC / N125-200H-CC W/C

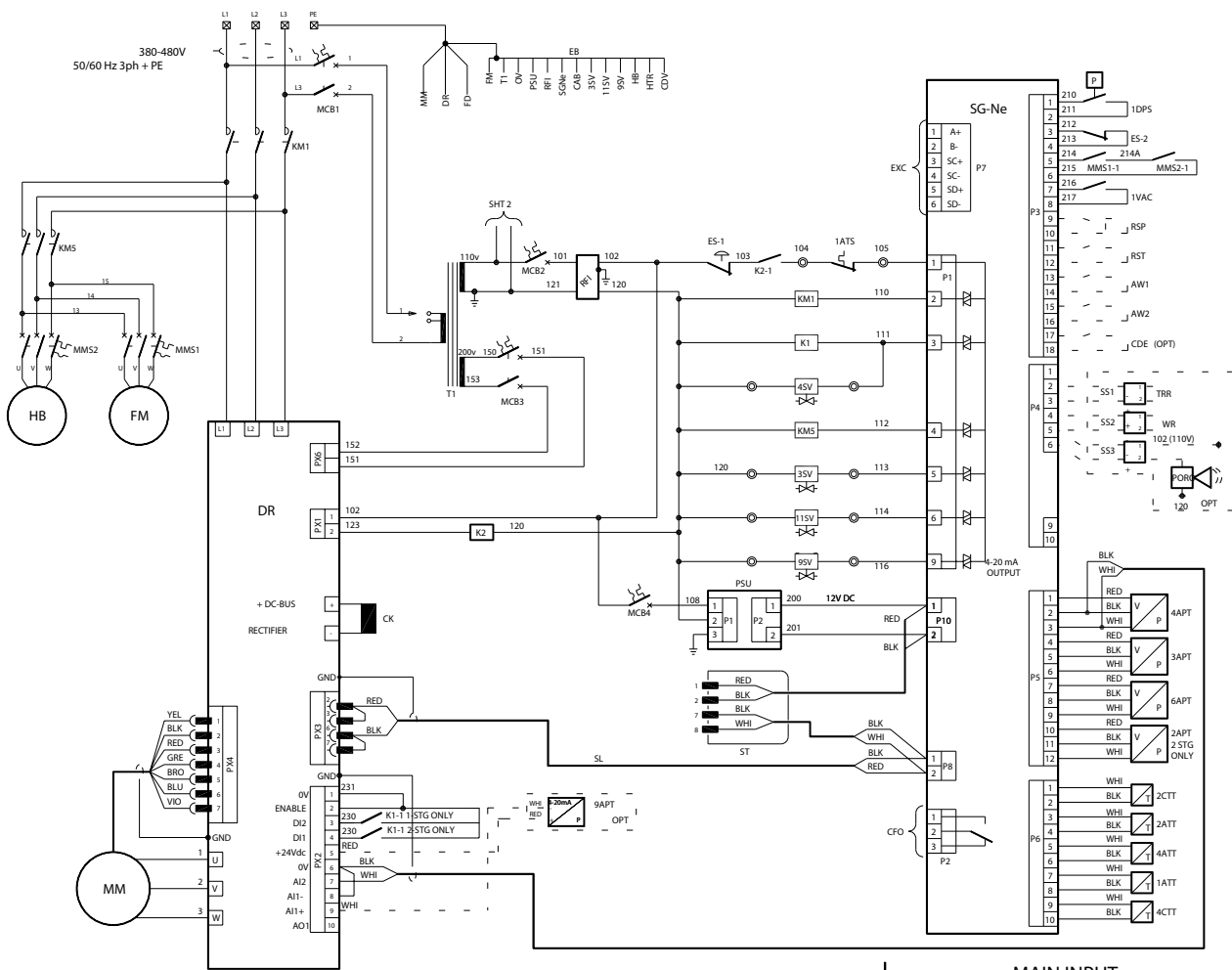

HEATER CIRCUITS:-

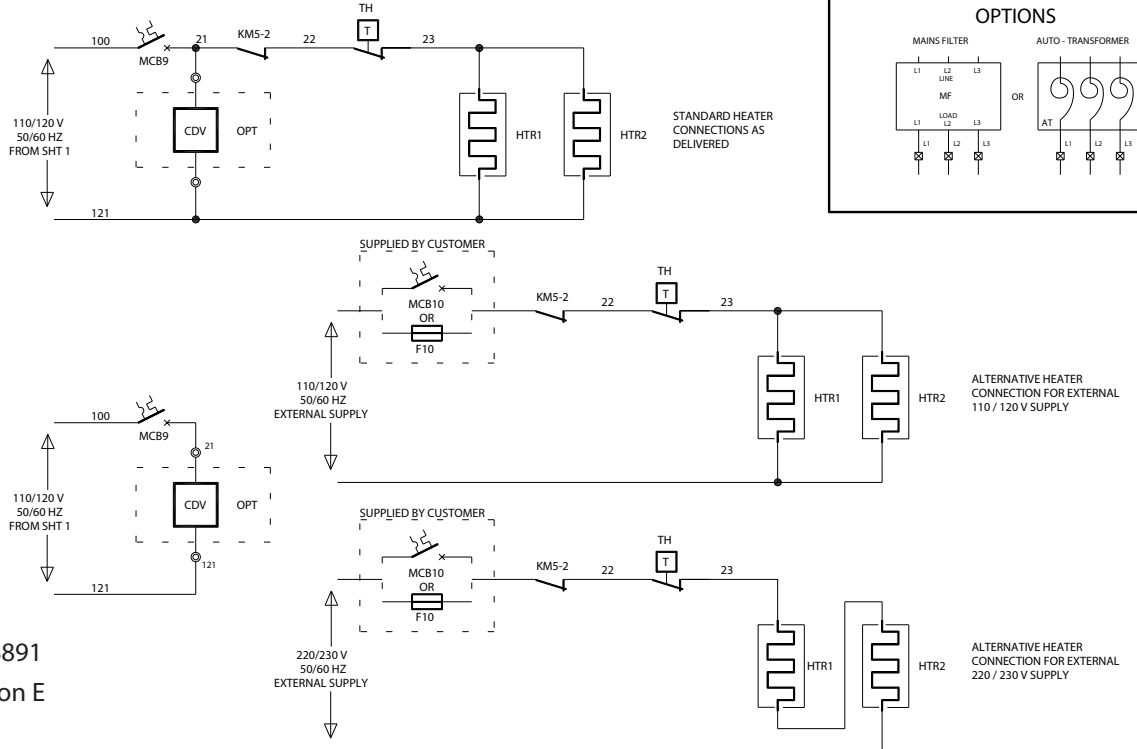

MAIN INPUT TERMINALS OPTIONS

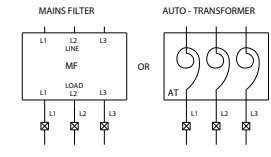

22258891
Revision E

8.0 GENERAL INFORMATION

KEY

1ATS	SWITCH, HIGH AIR END DISCHARGE TEMPERATURE	MM	MOTOR, MAIN
1ATT	SENSOR, INLET TEMPERATURE	MMS1	BREAKER, FAN MOTOR
1DPS	SWITCH, FOULED OIL FILTER	MMS2	BREAKER, HEATSINK BLOWER
1VAC	SWITCH, FOULED AIR FILTER	OPT	OPTIONAL
2APT	SENSOR, INTERSTAGE PRESSURE (2STG ONLY)	OV	ZERO VOLTAGE
2ATT	SENSOR, AIREND DISCHARGE TEMPERATURE	PE	PROTECTED EARTH
2CTT	SENSOR, INJECTED COOLENT TEMPERATURE	PORO	POWER OUTAGE RESTART OPTION (OPTIONAL)
3APT	TRANSDUCER, SUMP PRESSURE, WET SIDE	PSU	POWER SUPPLY UNIT
3SV	VALVE, BLOWDOWN SOLENOID	RFI	FILTER, RADIO FREQUENCY INTERFERENCE
4APT	TRANSDUCER, PACKAGE AIR DISCHARGE PRESSURE	RSP	REMOTE STOP
4ATT	SENSOR, PACKAGE AIR DISCHARGE TEMPERATURE	RST	REMOTE START
4CTT	SENSOR, OIL COOLER OUT TEMPERATURE	SGNe	CONTROLLER, INTELLISYS
4SV	VALVE, WATER STOP	SL	SERIAL LINK
6APT	TRANSDUCER, SUMP AIR PRESSURE, DRY SIDE	SS1-3	RELAY, SOLID STATE
9APT	TRANSMITTER, REMOTE AIR PRESSURE (OPTIONAL)	ST	SERVICE TOOL
9SV	VALVE, CONDENSATE DRAIN	T1	TRANSFORMER, CONTROL
11SV	VALVE, ANTI-CONDENSATION SOLENOID 1	TH	THERMOSTAT
AT	AUTOTRANSFORMER (IF FITTED)	TRR	TRUE RUNNING
AW1	AUXILIARY WARNING 1	COLOR	
AW2	AUXILIARY WARNING 2	BLK	BLACK
BP	BACKPLATE	BLU	BLUE
C	CAPACITOR	BRO	BROWN
CAB	CABINET	GRE	GREEN
CDE	CONDENSATE DRAIN ERROR (OPTIONAL)	PIN	PINK
CDV	CONDENSATE DRAIN VALVE (IF FITTED)	RED	RED
CFO	COMMON FAULT OUTPUT	SCR	SCREEN
CK	CHOKE	VIO	VIOLET
DR	DRIVE	WHI	WHITE
EB	EARTH BAR	YEL	YELLOW
ES	SWITCH, EMERGENCY STOP		
EXC	EXTERNAL COMMUNICATIONS	Wires	
F10	FUSE, EXTERNAL HEATER SUPPLY		
FM	MOTOR, BLOWER		
GND	GROUND		
HB	HEATSINK BLOWER		
HTR1	HEATER, 125 WATTS		
K1	RELAY, RUN		
K2	RELAY, FAULT		
KM1	CONTACTOR, MAIN MOTOR		
KM5	CONTACTOR, HEATSINK BLOWER		
MCB1	BREAKER, MINIATURE CIRCUIT, TRANSFORMER		
MCB2	BREAKER, MINIATURE CIRCUIT, CONTROL CIRCUITS		
MCB3	BREAKER, MINIATURE CIRCUIT, DR		
MCB4	BREAKER, MINIATURE CIRCUIT, PSU		
MCB9	BREAKER, MINIATURE CIRCUIT, HEATER		
MCB10	BREAKER, MINIATURE CIRCUIT, HEATER (EXTERNAL)		
MF	MAINS FILTER (IF FITTED)		

Numbers	Function	Wire color
1-99	Power	Black
100-199	AC Control	Red
200-299	DC Control	Blue
300-399	Auxiliary	Orange

NOTES:

1. FACTORY SUPPLIED AS SHOWN BY CONNECTION TO OUTPUT OF CONTROL TRANSFORMER T1. WIRE NUMBER 100 & 121.

2. ALTERNATIVELY THE SUPPLY MAY BE TAKEN FROM AN INDEPENDENT SOURCE: IN THAT CASE, FACTORY SUPPLIED CONNECTION MUST BE DISCONNECTED.

3. ENSURE PARALLEL CONNECTION OF HEATERS.

NOTES:

1. CONNECTIONS FOR USE ON 200/230V SYSTEMS. THE SUPPLY IS INDEPENDENT OF THE MAIN COMPRESSOR. THE CUSTOMER MUST PROVIDE AN ISOLATOR / DISCONNECT SWITCH ADJACENT TO THE MACHINE FOR THIS SUPPLY. IN THAT CASE, FACTORY SUPPLIED CONNECTION MUST BE DISCONNECTED.

2. ENSURE SERIES CONNECTION OF HEATERS.

8.0 GENERAL INFORMATION

8.4 WIRING SCHEMATIC - N250-300H

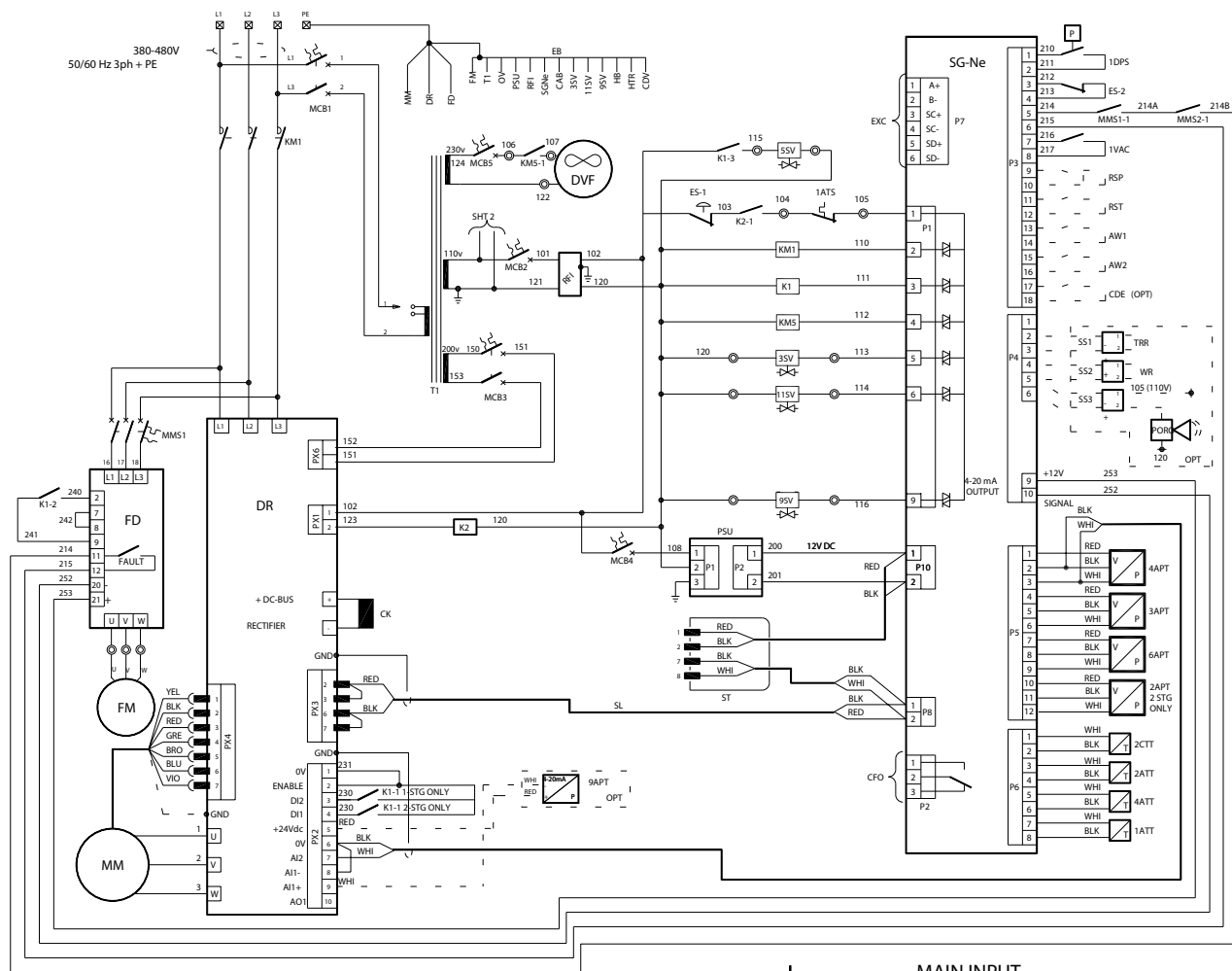

HEATER CIRCUITS:-

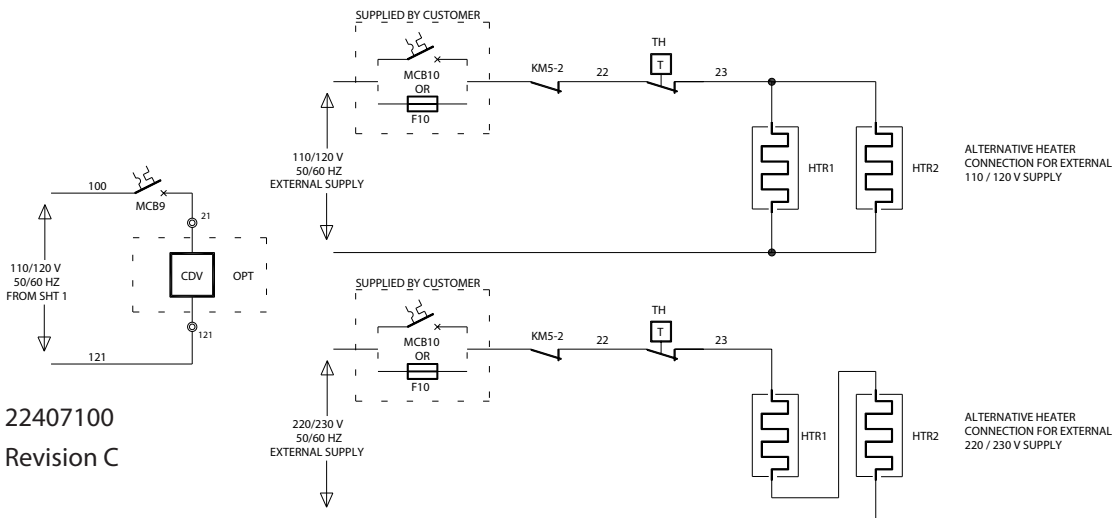
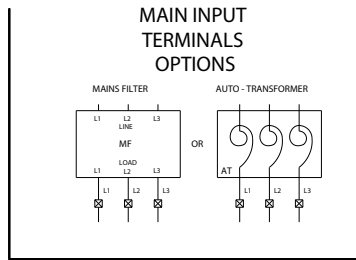
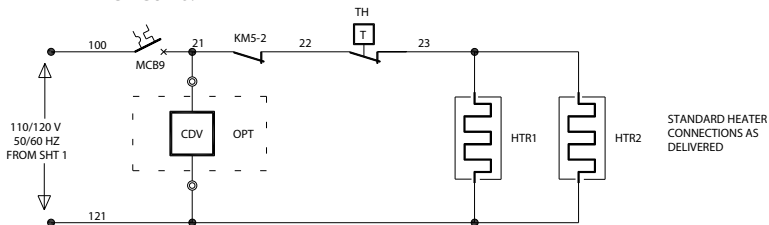

22407100
Revision C

8.0 GENERAL INFORMATION

KEY

1ATS	SWITCH, HIGH AIR END DISCHARGE TEMPERATURE	MMS1	BREAKER, FAN MOTOR															
1ATT	SENSOR, INLET TEMPERATURE	OPT	OPTIONAL															
1DPS	SWITCH, FOULED OIL FILTER	OV	ZERO VOLTAGE															
1VAC	SWITCH, FOULED AIR FILTER	PE	PROTECTIVE EARTH															
2APT	SENSOR, INTERSTAGE PRESSURE (2STG ONLY)	PORO	POWER OUTAGE RESTART OPTION (OPTIONAL)															
2ATT	SENSOR, AIREND DISCHARGE TEMPERATURE	PSU	POWER SUPPLY UNIT															
2CTT	SENSOR, INJECTED COOLENT TEMPERATURE	RFI	FILTER, RADIO FREQUENCY INTERFERENCE															
3APT	TRANSDUCER, SUMP PRESSURE, WET SIDE	RSP	REMOTE STOP															
3SV	VALVE, BLOWDOWN SOLENOID	RST	REMOTE START															
4APT	TRANSDUCER, PACKAGE AIR DISCHARGE PRESSURE	SGNe	CONTROLLER, INTELLISYS															
4ATT	SENSOR, PACKAGE AIR DISCHARGE TEMPERATURE	SL	SERIAL LINK															
6APT	TRANSDUCER, SUMP AIR PRESSURE, DRY SIDE	SS1-3	RELAY, SOLID STATE															
9APT	TRANSDUCER, REMOTE AIR PRESSURE (OPTIONAL)	ST	SERVICE TOOL															
9SV	VALVE, CONDENSATE DRAIN	T1	TRANSFORMER, CONTROL															
11SV	VALVE, ANTI-CONDENSATION SOLENOID 1	TH	THERMOSTAT															
AT	AUTOTRANSFORMER (IF FITTED)	TRR	TRUE RUNNING															
AW1	AUXILIARY WARNING 1	DVF	FAN, DRIVE VENTILATION															
AW2	AUXILIARY WARNING 2	5SV	VALVE, COOLANT STOP															
BP	BACKPLATE	COLOR																
C	CAPACITOR	BLK	BLACK															
CAB	CABINET	BLU	BLUE															
CDE	CONDENSATE DRAIN ERROR (OPTIONAL)	BRO	BROWN															
CDV	CONDENSATE DRAIN VALVE (IF FITTED)	GRE	GREEN															
CFO	COMMON FAULT OUTPUT	PIN	PINK															
CK	CHOKE	RED	RED															
DR	DRIVE	SCR	SCREEN															
EB	EARTH BAR	VIO	VIOLET															
ES	SWITCH, EMERGENCY STOP	WHI	WHITE															
EXC	EXTERNAL COMMUNICATIONS	YEL	YELLOW															
F10	FUSE, EXTERNAL HEATER SUPPLY	Wires																
FD	FAN DRIVE	<table border="1" style="width: 100%; border-collapse: collapse;"> <thead> <tr> <th style="text-align: center;">Numbers</th> <th style="text-align: center;">Function</th> <th style="text-align: center;">Wire color</th> </tr> </thead> <tbody> <tr> <td>1-99</td> <td>Power</td> <td>Black</td> </tr> <tr> <td>100-199</td> <td>AC Control</td> <td>Red</td> </tr> <tr> <td>200-299</td> <td>DC Control</td> <td>Blue</td> </tr> <tr> <td>300-399</td> <td>Auxiliary</td> <td>Orange</td> </tr> </tbody> </table>		Numbers	Function	Wire color	1-99	Power	Black	100-199	AC Control	Red	200-299	DC Control	Blue	300-399	Auxiliary	Orange
Numbers	Function			Wire color														
1-99	Power			Black														
100-199	AC Control			Red														
200-299	DC Control	Blue																
300-399	Auxiliary	Orange																
FM	MOTOR, BLOWER																	
GND	GROUND																	
HTR1	HEATER, 125 WATTS																	
K1	RELAY, RUN	NOTES:																
K2	RELAY, FAULT	1. FACTORY SUPPLIED AS SHOWN BY CONNECTION TO OUTPUT OF CONTROL TRANSFORMER T1. WIRE NUMBER 100 & 121.																
KM1	CONTACTOR, MAIN MOTOR	2. ALTERNATIVELY THE SUPPLY MAY BE TAKEN FROM AN INDEPENDENT SOURCE: IN THAT CASE, FACTORY SUPPLIED CONNECTION MUST BE DISCONNECTED.																
KM5	CONTACTOR, HEATSINK BLOWER	3. ENSURE PARALLEL CONNECTION OF HEATERS.																
MCB1	BREAKER, MINIATURE CIRCUIT, TRANSFORMER	NOTES:																
MCB2	BREAKER, MINIATURE CIRCUIT, CONTROL CIRCUITS	1. CONNECTIONS FOR USE ON 200/230V SYSTEMS. THE SUPPLY IS INDEPENDENT OF THE MAIN COMPRESSOR. THE CUSTOMER MUST PROVIDE AN ISOLATOR / DISCONNECT SWITCH ADJACENT TO THE MACHINE FOR THIS SUPPLY. IN THAT CASE, FACTORY SUPPLIED CONNECTION MUST BE DISCONNECTED.																
MCB3	BREAKER, MINIATURE CIRCUIT, DR	2. ENSURE SERIES CONNECTION OF HEATERS.																
MCB4	BREAKER, MINIATURE CIRCUIT, PSU																	
MCB9	BREAKER, MINIATURE CIRCUIT, HEATER																	
MCB10	BREAKER, MINIATURE CIRCUIT, HEATER (EXTERNAL)																	
MF	MAINS FILTER																	
MM	MOTOR, MAIN																	

8.0 GENERAL INFORMATION

8.5 GENERAL DESCRIPTION

The compressor is an electric motor driven, contact cooled screw compressor, complete with all necessary components piped, wired and baseplate mounted. It is a totally self contained air compressor package.

The standard compressor is designed to operate in an ambient range of 1.7° C to 46° C (35° F to 115° F). The standard maximum temperature of 46° C (115° F) is applicable up to an elevation of 1000m (3280ft) above sea level. Above this altitude significant reductions in ambient temperature are required if a standard motor is to be used.

The compressor is managed by the onboard electronic controller. The controller and drive system operate together to vary the speed of the compressor to deliver compressed air at the target pressure.

Panel instrumentation is provided to indicate the compressor operating conditions and general status.

The air/coolant mixture discharges from the compressor into the separation system. This system removes all but a few PPM of the coolant from the discharge air. The coolant is returned to the cooling system and the air passes to the aftercooler and out of the compressor through the moisture separator.

Air is pulled into the machine by the cooling blower (N250-300H use a propeller fan for cooling) and through the combined cooler / aftercooler.

By cooling the discharge air, much of the water vapor naturally contained in the air is condensed and is drained from the built-in moisture separator and drain.

The coolant system consists of a sump, cooler, thermostatic valve, anti-condensation valve and a filter. When the unit is operating, coolant is forced by air pressure from the separator tank to the thermostatic element. The position of the element (a direct result of coolant temperature) will determine whether the coolant circulates through the cooler, bypasses the cooler, or mixes the two paths together to maintain an optimum compressor injection temperature. The two position anti-condensation valve can reduce the coolant flow and hence the temperature rise of coolant through the compressor. This temperature is controlled to preclude the possibility of water vapor condensing. By injecting coolant at a sufficiently high temperature, the discharge air coolant mixture temperature will be kept above the dew point. On the N90/160K, N125/200H-SS, N75/160K-2S, N100/200H-2S and N250/300H-2S, the system is enhanced by a control logic that varies the cooling blower speed dependant on the intake and discharge temperatures and hence controls the injection temperature even closer while saving blower motor energy.

The compressor is provided with a temperature sensor which will shut the unit down in case of excessive temperature, 109° C (228° F).

Effective coolant filtration is provided by the use of a screw on, heavy duty coolant filter.

NOTICE

Nirvana air compressors are factory filled with SSR ULTRA COOLANT which is designed to operate for 8,000 hours or two years, whichever comes first.

Units supplied with optional Food Grade Coolant are designed to operate 1000 hours or 6 months, whichever comes first.

The coolant must be changed at these intervals to avoid breakdown and equipment damage.

9.0 OPERATING INSTRUCTIONS

9.1 BASIC OPERATION

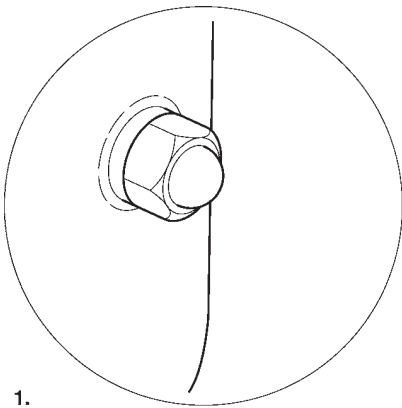

1.

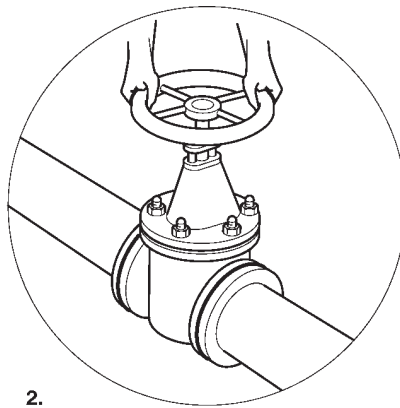

2.

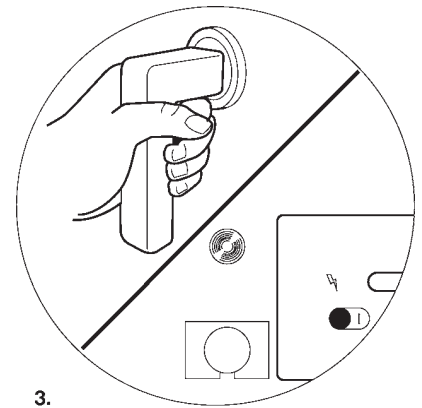

3.

T5716
Revision 00
06/01

⚠ WARNING

Ensure that all protective covers/guards are in place before attempting to start the machine.

⚠ WARNING

The compressor can operate in a pressurized shutdown mode. If the compressor stops automatically, the airend, separator tank and oil system can contain high pressure air. This can be relieved by pressing the emergency stop button and can be verified by unscrewing the coolant fill plug which has a vent hole through which any residual pressure will be vented. Downstream of the separator tank may still contain system pressure which must also be vented.

NOTICE

The language and units of measure displayed on the Intellisys controller will be pre-set before leaving the factory. If these are required to be changed, contact your local Ingersoll Rand Service Department, Distributor or Air Center.

Prior to starting

Refer to diagram T5716 above.

Check that the coolant level is at least visible in the center of the sight glass, add coolant if necessary. Refer to maintenance procedures for setting correct level.

Ensure that the discharge air isolation valve is open. Switch on the main electrical isolation switch. The control panel will illuminate, indicating that the line and control voltages are available.

The contrast of the display may be adjusted by turning the small screw which is on the right hand side of the controller when accessed through the starter cabinet door.

Initial check sequence

The controller will perform an initial check sequence if the compressor (1) receives initial power to the controller or (2) has experienced an alarm reset. While the initial check sequence occurs, the controller will display a "Checking Machine" message.

During the initial check sequence, the controller will check the control system for proper operation. During this time, if any items are found inoperative an alarm will occur and the unit will not start.

After completion of the initial check sequence, the controller will then display "READY TO START". This process should be completed within 10 seconds.

9.0 OPERATING INSTRUCTIONS

Start sequence

The compressor will initially start by the operator pressing the local start button or receiving a remote start command. The compressor will start loaded and will ramp up the motor speed to its minimum speed. Once the minimum speed has been achieved, the compressor will begin to control pressure by using its speed regulation. When the system pressure reaches the target pressure, the compressor will start to slow. If the system pressure rises to the immediate stop pressure setpoint the compressor will stop. If the system pressure rises to the auto stop setpoint and the compressor is at minimum speed, if the blowdown mode is set to off, the compressor will stop. However if the blowdown mode is set to on, the compressor will open the blowdown valve for up to 10 seconds or until the pressure in the separator tank falls to 2.4 Bar (35 psi) before stopping. The compressor will restart once the system pressure falls below the target pressure.

Stop sequence

The compressor can be stopped by a local or remote stop, a shutdown due to an alarm or an emergency stop. All of the above conditions will cause the compressor to stop immediately, except the local or remote stop. A local or remote stop will open the blowdown valve and the compressor will run for up to 10 seconds or until the pressure in the separator tank falls to 35 psi before stopping. The compressor will stop if the system pressure reaches the automatic stop or immediate stop pressure setpoints. However, if the compressor stops for this reason, it will automatically restart when the system pressure falls below the target pressure.

The N250/300H – 2S compressor will operate for 30 seconds with the blowdown valve open and at reduced speed before stopping. This sequence occurs for local or remote stops and when the system pressure reaches the automatic or immediate stop pressure setpoints. The compressor will automatically restart when the system pressure falls below the target pressure.

Important: Depress the emergency stop button when the compressor must be stopped immediately.

Blowdown mode

All 2 stage compressors will blowdown when compressor is signaled to stop. Intellisys indicates that Blowdown Mode is “not installed”.

If the blowdown mode is set to on, the compressor will open the blowdown valve anytime that it stops. This will release pressure from the airen and separator tank. If the blowdown mode is set to off, the blowdown valve will remain closed when the compressor stops due to an automatic stop

Blower control N37/160K–1S, N50/200H–1S & N75/160–2S, N100/200H–2S Fan control N250/300H–2S

The blower speed varies in some conditions to assist in controlling the coolant injection temperature. The blower motor has its own variable speed drive and will ramp up and down as the compressor starts and stops.

Stopping the machine in an emergency

If the machine has to be stopped in an emergency **DEPRESS THE EMERGENCY STOP BUTTON LOCATED UNDERNEATH THE INSTRUMENT PANEL.**

This will over-ride the normal unload/stop button and will immediately stop the machine.

Restarting after an emergency

If the unit has been switched off because of a machine malfunction, identify and correct the fault before attempting to restart.

If the unit has been switched off for reasons of safety, ensure that the machine can be operated safely before restarting.

Refer to the *PRIOR TO STARTING* and *START SEQUENCE* instructions earlier in this section before restarting the machine.

9.0 OPERATING INSTRUCTIONS

9.2 INTELLISYS CONTROLS

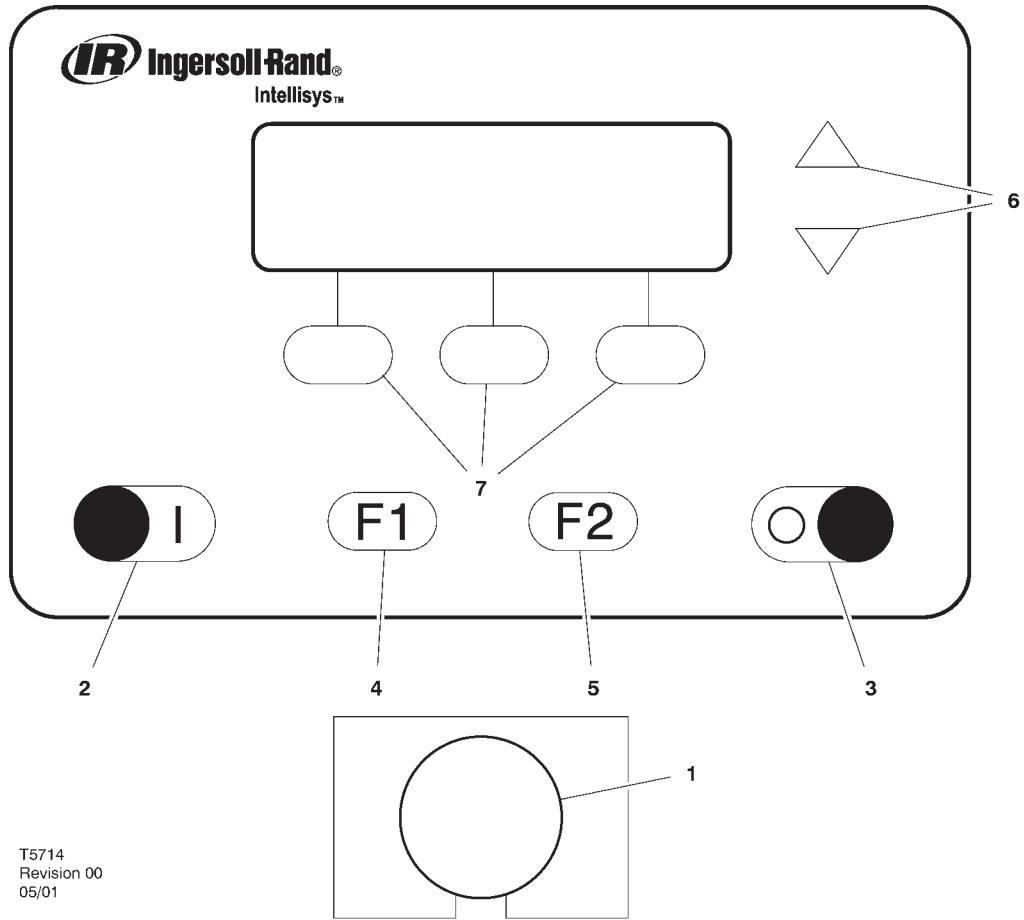

1. Emergency stop

Pressing this switch stops the compressor immediately. The blowdown valve will open to vent pressure in the separator tank to atmosphere. Note: the system downstream of the separator tank may still contain pressure. The compressors can not be restarted until the switch is manually reset. Turn the switch knob clockwise and press the reset button twice to reset.

On reset the controller will display a message, indicating that the compressor is ready to start.

2. Start

Pressing this button will activate the start sequence.

3. Stop

Pressing this button will activate the stop sequence.

4. F1

Not used.

5. F2

Not used.

6. Arrows

These up and down buttons have multiple functions relating to the right half of the display screen. When lists are presented, the buttons are used to move up or down through the items on the list. The small arrow(s) displayed in the upper right hand corner of the display screen indicate when you can move up (designated by arrow head pointing up) and/or down (designated by arrow head pointing down) through the list.

When the value of a specific machine operating parameter is highlighted on the display screen for the purpose of changing that value, the buttons are used to change the value itself.

7. Display buttons

The functions of the three buttons below the display screen change and are defined by the words immediately above them in the bottom line of the screen. Each function, such as MAIN MENU, STATUS, etc., is described in appropriate sections in this manual.

9.0 OPERATING INSTRUCTIONS

9.3 DISPLAY SCREEN

The display screen is divided into three functional areas, as seen in the typical CURRENT STATUS screen shown here.

The left side continuously shows the package discharge pressure in large numbers with the line directly below showing the running condition of the machine

<div style="border: 1px solid black; display: inline-block; padding: 2px 10px;">100</div> PSI READY TO START	– CURRENT STATUS – PACKAGE DISCHARGE TEMP 102° F AIREND DISCHARGE TEMP 192° F
MAIN MENU	

The right side shows various items or lists such as the machine's CURRENT STATUS readings, the MAIN MENU, the OPERATOR SETPOINTS list, etc. Any of the lists can be moved up or down by pressing the arrow buttons to the right of the screen. The small arrow(s) displayed in the upper right corner of the screen indicate when you can move up and/or down through a list. The arrow buttons are also used to change an individual item's value. At certain times, items and/or their values are "highlighted". This means that they are displayed as light characters on a dark background.

The bottom of the screen is divided into thirds with the words in each small box showing the function of the button directly beneath it. The words will change in these boxes depending on what actions are permitted at any particular time. The action resulting from pressing each of these buttons is indicated in the Operator Panel Flow Diagram later in this section. This can be used as a quick reference of how to step the controller screen through any desired function.

9.0 OPERATING INSTRUCTIONS

9.4 CURRENT STATUS SCREEN

The CURRENT STATUS screen is considered to be the "normal" display that the controller shows.

The following items and their present values can be displayed on the right side of the screen by pressing the up and down arrow buttons

The controller automatically returns the display to this CURRENT STATUS screen from other screens if no buttons are pressed within 30 seconds.

Use the UP and DOWN arrows to move between selections.

CURRENT STATUS items

- 1 % Energy Saving
- 2 % Capacity
- 3 Package kW
- 4 Package Discharge Temperature
- 5 Airend Discharge Temperature
- 6 Injected Coolant Temperature
- 7 Inlet Temperature
- 8 Sump Pressure
- 9 Separator Pressure Drop
- 10 Interstage Pressure
- 11 Coolant Filter
- 12 Inlet Filter
- 13 Total Hours

- 14 Motor Speed
- 15 Motor Current
- 16 Motor Voltage
- 17 Input Voltage
- 18 DC Bus Voltage
- 19 Remote Pressure (optional)
- 20 Time and Date
- 21 Program Name
- 22 Version of Drive Software

When the CURRENT STATUS screen is displayed, pressing the ENERGY STATUS button will toggle the display to the ENERGY STATUS screen. Likewise, when the ENERGY STATUS screen is displayed, pressing the STATUS button will toggle the display to the CURRENT STATUS screen.

The ENERGY STATUS screen displays the following items.

ENERGY STATUS Items

- 1 Average Package kW-hr
- 2 Average % Capacity
- 3 Average Capacity
- 4 Energy Cost
- 5 Energy Savings
- 6 Lifetime Energy Savings

9.0 OPERATING INSTRUCTIONS

9.5 MAIN MENU

The MAIN MENU screen can be accessed from the CURRENT STATUS screen by pressing the MAIN MENU button, identified by the words "MAIN MENU" in the bottom line of the screen directly above the center button.

The MAIN MENU screen is the point from which various operator functions can be accessed. Refer to the Operator Panel Flow Diagram.

Each of the functions can be chosen by using the up and down arrows to highlight it on the screen.

The controller will go to the highlighted function if the SELECT button is pressed or will return to the CURRENT STATUS screen if the STATUS button is pressed.

The language and units of measure are pre-set prior to the compressor leaving the factory.

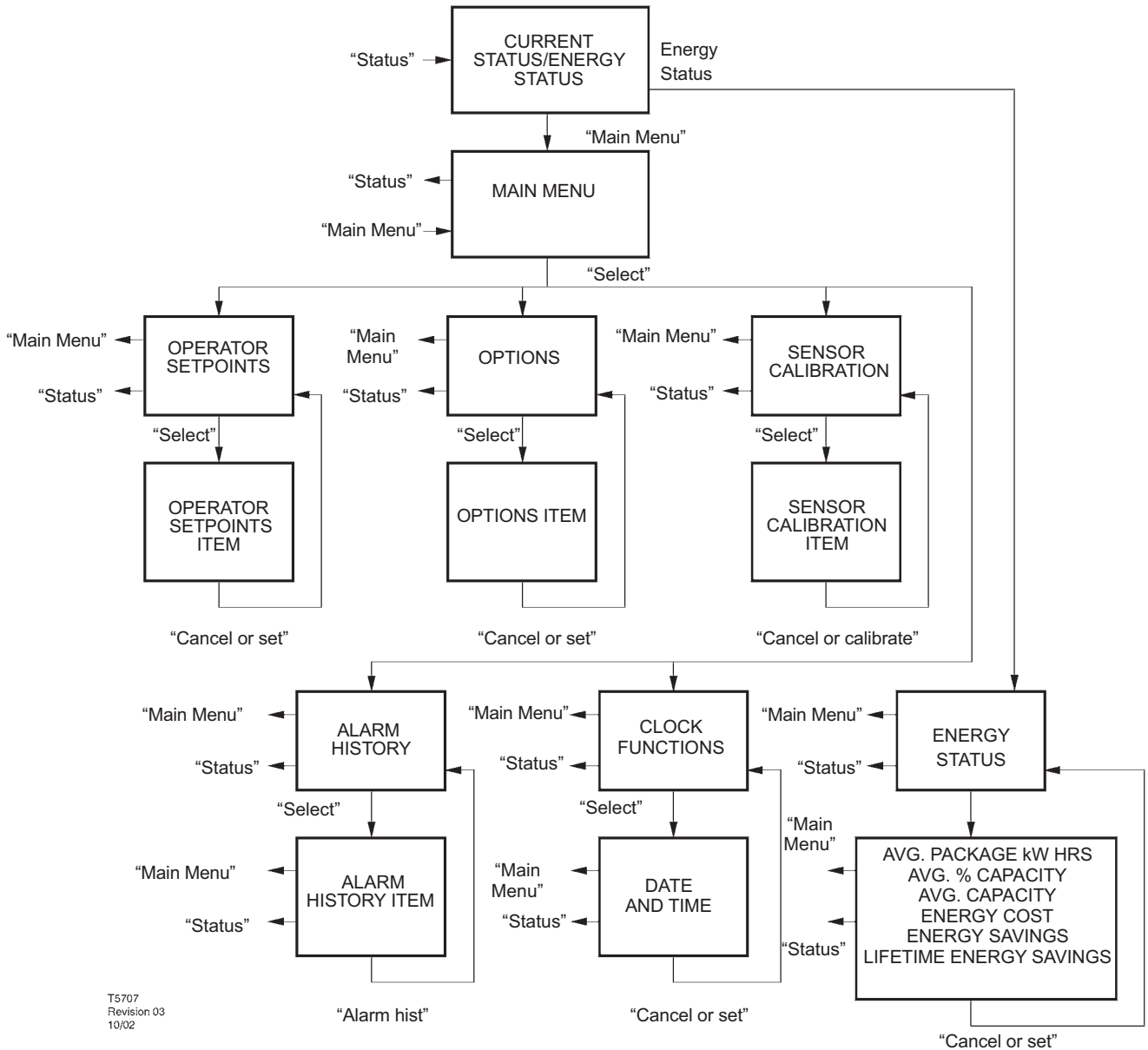
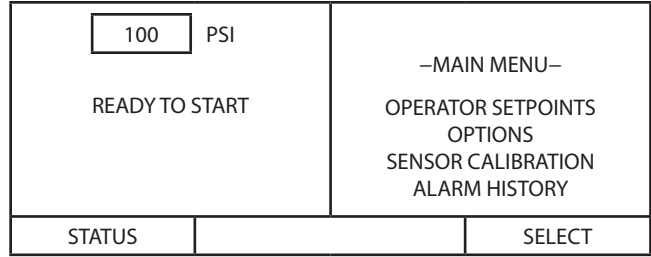

T5707
Revision 03
10/02

9.0 OPERATING INSTRUCTIONS

9.6 OPERATOR SETPOINTS

Setpoints are user-adjustable variables in the controller logic that can be set using the OPERATOR SETPOINTS screen shown opposite.

The name and value of each of the setpoints listed can be seen on the screen by moving the list up and down using the arrow buttons.

Setpoints associated with options are described in the OPTIONS sections.

<div style="border: 1px solid black; display: inline-block; padding: 2px 10px;">100</div> PSI READY TO START	OPERATOR SETPOINTS– TARGET PRESSURE 105 psi	
STATUS	MAIN MENU	SELECT

FACTORY DEFAULTS

OPERATOR SETPOINTS	DEFAULT	MIN.	MAX.	STEP	UNIT
Target pressure	100	65	145 / 203	1	PSI
Automatic stop pressure	110	Target +1	Target +10	1	PSI
Immediate stop pressure	120	Auto	Auto +10	1	PSI
Blowdown mode	Off	Off	On	–	–
Condensate release	5	2	20	1	SEC.
Condensate interval	180	90	270	1	SEC.
% savings compared to	Modulation	–	–	–	–
Energy Rate	0	0	9999.999	–	–
Reset Avg.	--	–	–	Reset Date	–
Service menu	1	1	25535	1	–

A setpoint's value can be changed by first highlighting the item and its value and pressing the SELECT button to highlight just the value. When the value line is highlighted by itself, the value can be adjusted using the up and down arrow buttons. The CANCEL and SET buttons appear at this time. Press the SET button to enter the new value or press the CANCEL button to return the value of the setpoint prior to using the arrows. The displayed value will flash twice to indicate that it has been entered into the setpoint and the pair of setpoint item and value display lines will again be highlighted together.

Unit	Min	Max (1S / 2S)	Step
PSI	65	145 / 203	1
BAR	4.4	10 / 14	0.1
kPa	440	1000 / 1400	10
KGCM2	4.5	10.2 / 14.2	0.1

Note: the max target pressure for N250/300H–2S is 145 PSI, 10 BAR, 1000 kPa, 10.2 KGCM2.

Operator setpoints can be exited by pressing the STATUS or MAIN MENU buttons. If no buttons are pressed within 30 seconds, the display will return to the CURRENT STATUS screen.

Target pressure

The compressor will try to operate at this pressure setting. The target pressure ranges and step sizes for each unit of measure are listed in the table below.

9.0 OPERATING INSTRUCTIONS

Automatic stop pressure

The compressor will stop once the system pressure rises to this pressure and the compressor is operating at the minimum speed. The range for this setpoint will be the target pressure+1 to target pressure+10 psi if the target pressure is 145 psi or less, to target pressure+7 psi if the target pressure is greater than 145, but less than or equal to 175 psi, or target pressure +5 psi if the target pressure is greater than 175 psi. If the remote sensor is 'on', the maximum automatic stop pressure will always be target pressure +5 psi.

Immediate stop pressure

The compressor will stop if the system pressure rises to this pressure. The range for this setpoint will be the automatic stop pressure to automatic stop pressure+10 psi if the target pressure is 145 psi or less, to automatic stop pressure+7 psi if the target pressure is greater than 145, but less than or equal to 175 psi, or automatic stop pressure +5 psi if the target pressure is greater than 175 psi. If the remote sensor is 'on', the maximum immediate stop pressure will always be automatic stop pressure +5 psi.

Blowdown Mode

2 stage compressors will always blowdown when signaled to stop.

If this mode is selected to ON the compressor will open the blowdown valve anytime that it stops. This will vent pressure from the airend and the separator tank. If this mode is selected to OFF the blowdown valve will remain closed when the compressor stops due to an automatic stop. Blowdown mode is set on at all times for 2 stage models. Blowdown mode will be shown as "Not Installed" at the controller display.

Condensate Release

This is the number of seconds that the condensate solenoid will be open (energized) when blowing out the condensation.

Condensate Interval

This is the time interval between condensation blowdowns

% savings compared to

This setpoint is to determine what Nirvana's percent of savings is compared to. The modes of operation for comparing Nirvana to are modulation, online/offline, and geometry. The percent savings value is displayed by the status message, % energy savings

Energy Rate

The energy cost and the energy savings items on the ENERGY STATUS screen will use this value for their calculations. It is intended to be a monetary value representing the user's power cost per kilowatt hour.

Reset Averaging

When this setpoint is selected and the SET button is pressed, the items on the ENERGY STATUS screen will be reset, and the date the reset occurred will be displayed in this setpoint. This selects the beginning of the time period over which the ENERGY STATUS information will be calculated. Note that the "Lifetime Energy Savings" item will not be reset.

Service Menu

For use by IR personnel only.

9.0 OPERATING INSTRUCTIONS

9.7 OPTIONS

Options are turned on or off and their associated values are set using the OPTION screen shown opposite.

Some options are purchased, they require additional machine hardware and must first be enabled by service personnel. The name and value of each of the following options can be seen by moving the list up and down using the arrow buttons

An Option item's value can be changed the same way that OPERATOR SETPOINTS values are changed.

<div style="border: 1px solid black; display: inline-block; padding: 2px 10px;">100</div> PSI READY TO START	-OPTIONS- REMOTE START/STOP ON REMOTE START/STOP ON	
STATUS	MAIN MENU	SELECT

OPTIONS Items	SELECTION	MIN.	MAX.	Step	Unit	Installed Option Required
Remote Pressure Sensor	ON/OFF					No
Sequencer	ON/OFF					No
Remote Start/Stop	ON/OFF					Yes
Power Out Restart	ON/OFF					Yes
Power Out Restart Time		10	600	1	SEC	Yes
Scheduled Start Day		day	day	1	day	Yes
Scheduled Start		00:00	23:59	1	time	Yes
Scheduled Stop Day		day	day	1	day	Yes
Scheduled Stop		00:00	23:59	1	time	Yes
Modbus Protocol	ON/OFF/ICU					No
Modbus Address		1	247	1		No

Remote pressure sensor

If this setting is set to ON, the compressor will use a remote mounted pressure sensor for controlling system pressure by comparing it to the Target Pressure setting and the Auto Stop Pressure setting. The pressure measured by this sensor is shown in the CURRENT STATUS display as the Remote Pressure reading. The local sensor at the package discharge is still used for Immediate Stop, for certain Alarm conditions and for display on the left side of the screen.

Sequencer

If this setting is set to ON, the compressor will be able to start and stop by commands from a host device. When the Intellisys receives a load command from the host device, the compressor will start. When the Intellisys receives an unload command the compressor will respond as though executing an immediate stop.

Remote start/stop

If the remote start/stop option is installed and this setting is set to ON, the compressor can be started and stopped from a remote device.

Power out restart

If this setting is set to ON, the compressor will automatically restart when power is returned to the compressor if it was operating when power was removed.

Note:

A kit including instruction manual is required to install this option.

Power out restart time

If the power out restart setting is set to ON, this is the number of seconds from the time power is restored until the compressor starts. The power out restart horn will sound during this time.

Scheduled start day

This option is the selection for the day that a scheduled start will take place. The selections are Sunday, Monday, Tuesday, Wednesday, Thursday, Friday, Saturday, Daily (Su- Sa), Weekdays (M - F), or Weekends. This option setpoint will work with the scheduled start setpoint.

9.0 OPERATING INSTRUCTIONS

Scheduled start

This option will cause the unit to start on the scheduled start day, at the time stored in this setpoint. To disable this option, set the value of scheduled start equal to the value of scheduled stop.

Scheduled stop day

This option is the selection for the day that a scheduled stop will take place. The selections are Sunday, Monday, Tuesday, Wednesday, Thursday, Friday, Saturday, Daily (Su - Sa), Weekdays (M - F), or Weekends. This option setpoint will work with the scheduled stop setpoint.

Scheduled stop

This option will cause the unit to stop on the scheduled stop day, at the time stored in this setpoint. To disable this option, set the value of scheduled stop equal to the value of scheduled start.

Modbus protocol and address

See the Modbus manual.

9.8 SENSOR CALIBRATION

Pressure sensor calibration is done through the SENSOR CALIBRATION screen. Sensor calibration can only take place when the machine is stopped. Calibration needs to be done only after a sensor has been replaced or the Intellisys controller has been replaced.

100 PSI		-SENSOR CALIBRATION-	
READY TO START		SENSOR 4APT CALIBRATE SENSOR 3APT CALIBRATE	
STATUS	MAIN MENU	SELECT	

Each of the sensors listed below can be chosen by using the up and down arrow buttons to highlight it on the screen.

SENSOR CALIBRATION Items

Sensor 4APT (Package Discharge)
Sensor 3APT (Wet Side Sump)
Sensor 6APT (Dry Side Sump)
Sensor 2APT (Interstage)
Sensor 9APT (Remote Sensor)

Select the highlighted sensor by pressing the SELECT button. Press the CALIBRATE button to start the automatic calibration procedure, or press the CANCEL button to not calibrate it and return to the sensor list.

The calibration screen can be exited by pressing either the STATUS or MAIN MENU buttons. If no buttons are pressed within 30 seconds, the display will return to the CURRENT STATUS screen.

9.0 OPERATING INSTRUCTIONS

9.9 ALARM HISTORY

Alarm History displays each of the Alarm messages for the last 15 Alarms experienced by the machine. It also gives access to displaying the machine operating conditions that existed at the time of each Alarm. The first one shown, "Alarm History 1", was the most recent Alarm to occur. Note that multiple, consecutive EMERGENCY STOP Alarms are not recorded as separate Alarms, only the first one will be shown.

100 PSI		READY TO START		-ALARM HISTORY- ALARM HISTORY 1 BLOWER MOTOR OVERLOAD ALARM HISTORY 2 HIGH AIREND DISCH TEMP	
STATUS		MAIN MENU		SELECT	

Each of the last 15 Alarm messages can be seen by moving the Alarm History list up and down using the arrow buttons. Pressing the SELECT button when one of the Alarms is highlighted will display the list of machine values that existed at the time that particular Alarm occurred.

The name and value of each of the items can be seen by moving the list up and down using the arrow buttons. Pressing the ALARM HIST. button will return the display to the ALARM HISTORY screen.

Alarm histories can be exited by pressing either the STATUS or MAIN MENU buttons. If no buttons are pressed within 30 seconds, the display will return to the CURRENT STATUS screen.

9.10 CLOCK FUNCTIONS

100 PSI		READY TO START		-CLOCK FUNCTIONS- Time 01:15 Date Jan 01, 00	
STATUS		MAIN MENU		SELECT	

The date and time for the real time clock is set through the CLOCK FUNCTIONS screen. Use the up and down arrows to highlight either TIME or DATE. Select the highlighted setting by pressing SELECT.

If TIME is selected, first the hours will be highlighted. Adjust the hours (00–23 hour clock) by using the up and down arrows. Once the correct time is in the display, press SET to highlight the minutes. Adjust the minutes (00–59) and then press SET to complete setting the time.

If DATE is selected, first the month will be highlighted. Adjust the month by using the up and down arrows and then press SET to highlight the date. Once the correct date is displayed, press SET to highlight the year. Once the correct year is displayed, press SET to complete setting the date.

9.0 OPERATING INSTRUCTIONS

9.11 ENERGY STATUS MESSAGES

<div style="border: 1px solid black; display: inline-block; padding: 2px 5px;">100</div> PSI	–ENERGY STATUS– AVERAGE PACKAGE kW HRS AVERAGE % CAPACITY– –AVERAGE CAPACITY
READY TO START	
STATUS	MAIN MENU SELECT

AVERAGE CAPACITY – Displays the compressor’s average capacity in cfm or m3 for the time period that was started by selecting the reset averaging setpoint.

ENERGY COST – Displays the energy cost of the compressor for the time period that was started by selecting the reset averaging setpoint. This is calculated by multiplying the kW hours of the motor and the blower by the energy rate.

ENERGY SAVINGS – Displays the energy savings of the compressor for the time period that was started by selecting the reset averaging setpoint as compared to a conventional compressor. This value is determined by calculating how much a conventional compressor motor would cost to operate at the same average capacity and then subtracting the motor energy cost of the Nirvana compressor from it. It is assumed that the blower cost is the same in both packages.

LIFETIME ENERGY SAVINGS – Displays the lifetime energy savings of the compressor at the existing energy rate and at the average percent capacity as compared to a conventional compressor.

The Energy Status display can be selected by pressing the ENERGY STATUS button. The following items and their present values will be displayed on the right side of the screen by pressing the up and down arrows.

AVERAGE PACKAGE kW HOURS – This displays the average package kW per hour for the time period that was started by selecting the reset averaging setpoint. This value includes the blower power usage.

AVERAGE % CAPACITY – Displays the compressor’s average percent capacity for the time period that was started by selecting the reset averaging setpoint. The value is determined by taking the average package kW per hour, removing the blower power usage and then dividing that number by the motor kW per hour for that size of compressor at 100% capacity.

9.0 OPERATING INSTRUCTIONS

9.12 WARNINGS

When a WARNING occurs, a large question mark will flash on the display screen.

If multiple WARNINGS exist, the small up/down arrows will appear in the upper right corner of the display screen. The multiple WARNINGS can be seen by pressing the up and down arrow buttons. Pressing the STATUS button will display the CURRENT STATUS screen with the WARNING button indicating that a WARNING still exists.

A WARNING will not cause the unit to shut down. The unit will continue to run in its normal operation and the WARNING will remain displayed until reset.

A Warning needs to be reset by the operator by pressing the RESET button twice.

The possible Warning messages are as follows;

HIGH AIREND DISCHARGE TEMP – This will occur if the Airend Discharge exceeds 97% of the alarm limit, 109° C (228° F) and is not adjustable.

CHANGE COOLANT FILTER – This warning will occur if the high side pressure is 1.4 bar (20 psig) greater than the low side pressure.

CHANGE INLET FILTER – This will occur if the Inlet Vacuum is greater than 0.05 bar (0.7 psig).

CHANGE SEPR ELEMENT – This will occur if the pressure differential across the separator is 1.0 bar (12 psig).

SENSOR FAILURE – This will occur if a sensor is recognized as missing or broken.

HIGH DISCHARGE PRESS – Will occur if the unit is under the control of an external device, such as an ISC, and the discharge pressure is greater than the immediate stop pressure.

AUXILIARY WARNING 1 or 2 – Will occur if the auxiliary warning input closes.

REMOTE PRESSURE SENSOR FAILURE (option) – This will occur if the remote pressure sensor fails. If this happens, the Intellisys will start using the package discharge pressure sensor to measure system pressure.

CONDENSATE DRAIN ERROR – On 2 stage units, this will occur if the condensate drain error contacts close while the unit is running.

9.13 SERVICE WARNINGS

SERVICE – Service warnings occur when the unit has operated a certain number of hours, based on the total hours, or has operated for a certain number of months, based on the real time clock. Service warnings can have multiple levels, depending on the service level selection.

This will be set prior to the compressor being shipped from the factory. When a service warning occurs, contact your local IR service representative.

9.14 INITIAL CHECK ALARMS:

The following alarms will only occur when the machine is not running. These alarms are related to high temperature, power loss, and sensor calibration. They will have the same display mode as other alarms.

HIGH AIREND DISCH TEMP – Will occur if airend discharge temperature is greater than 95% of 109° C (228° F).

CHECK SETPOINTS – Will occur if the controller has determined that some of the data stored in memory contains unacceptable values.

INVALID CALIBRATION – Will occur if the sensor zero value is –10% to +1% of its scale. See Sensor Calibration.

9.0 OPERATING INSTRUCTIONS

9.15 ALARMS

When an Alarm occurs, a large exclamation mark in a triangle will flash on the display screen. The display message will indicate what caused the Alarm.

The compressor will stop and cannot be re-started again until the alarm condition no longer exists and the alarm message reset.

Pressing the STATUS button will display the STATUS screen. The presence of the ALARM button indicates that an Alarm condition still exists. Alarm Status is the list of machine operating conditions that existed at the time of the Alarm.

The name and value of each of the items listed can be seen by moving the list up and down using the arrow buttons. Pressing the ALARM button will return the display to the Alarm screen and the RESET button.

The Alarm needs to be reset by the operator by pressing the RESET button twice. Any exceptions to this are explained in the alarm descriptions.

100 PSI		-ALARM STATUS- PACKAGE DISCH PRESSURE 100 psi PACKAGE DISCHARGE TEMP 103° F
STOPPED BY ALARM		
ALARM	MAIN MENU	

The possible Alarm messages are as follows;

EMERGENCY STOP– This will occur if the Emergency Stop button is engaged. The button must be disengaged before the alarm can be cleared.

BLOWER FAULT– This will occur if a blower fault is sensed.

HIGH AIREND DISCH TEMP– This will occur if the airend discharge temperature is greater than 109° C (228° F).

REMOTE START FAILURE– This will occur if the Remote Start button is pressed after the machine is running or if the Remote Start button remains closed.

REMOTE STOP FAILURE– This will occur if the Remote Stop button remains open and either Start button is pressed.

SENSOR FAILURE – This will occur if a sensor is recognized as missing or broken.

VSD FAULT – The VSD fault is read from the drive. The Intellisys will read the status menu of the variable speed drive. If a fault condition is returned in the status information, the Intellisys will issue a VSD FAULT alarm and display the number of the fault condition.

CONTROL POWER LOSS – This will occur if the control circuit is broken by a bad connection or safety switch (e.g. HAT Switch/ Phase Monitor). Any fall of voltage below 100VAC for more than 2 seconds will cause this alarm trip.

STOP FAILURE – This will occur if the compressor should be stopped but the motor is still running above minimum speed 4 seconds after the stop signal is given.

HIGH START PRESSURE – If the sump pressure is above 100 psi (6.9 bar) when the compressor starts, the Intellisys will open the blowdown valve during the first few seconds of starting (3 to 7 seconds). If the sump pressure does not fall to 100 psi (6.9 bar) during that time period, this shutdown will occur.

CHECK MOTOR ROTATION – This will occur if the Intellisys reads a negative speed from the VSD when starting .

VSD COMMUNICATION FAILURE – This will occur if the Intellisys does not receive a response from the VSD when requesting information. This alarm will take about 8 seconds to occur.

VSD INITIALIZATION FAULT – Will occur if the Intellisys is unable to establish communications with the VSD after a power up.

LOW SUMP PRESSURE – Will occur if the compressor is operating at or above the minimum speed and the sump pressure drops below 15psi (1.03 bar) for 15 seconds.

REPLACE COOLANT FILTER – This will occur if the coolant filter is blocked and requires changing.

INCORRECT VSD TYPE – Will occur at power up if the VSD type does not match the size of the compressor

125HP (90kW) machines and above also have the following alarm messages;

CONTROL POWER LOSS – This will occur if the compressor should be running and the AC input voltage, as read from the VSD, falls below 100 VAC. There is a delay of 2 seconds on this alarm in case the power quickly returns. An open HAT switch or phase monitor are two things that can cause this alarm.

STOP FAILURE – This will occur if the compressor should be stopped, but the motor speed has not dropped below the minimum motor speed setpoint. The Intellisys will wait 4 seconds for the compressor to stop before issuing this alarm.

HIGH INTERSTAGE PRESSURE – If the interstage pressure is over 100psi while the unit is running and the unit is a 2-stage.

10.0 MAINTENANCE

10.1 MAINTENANCE PROMPTS

The service warning and flashing LED will appear at intervals, dependant on the service level selected. Refer to operating instructions.

The customer can only reset the warning for 24 hours by pressing the "set" button.

IR service engineers will master reset the warning after completing the service work.

The service warning will return each subsequent 2000 hours.

The machine will be master reset after service work conducted prior to the 2000 hour interval to prevent false indication.

10.0 MAINTENANCE

10.2 MAINTENANCE CHART

The MAINTENANCE CHART indicates the various components and the intervals when maintenance has to take place. Where a service interval is stated in both hours and months, it is the sooner of the two intervals that must be adhered to. Coolant capacities etc can be found in the GENERAL INFORMATION section of this manual. Note that any Local or National codes that require specific maintenance that exceeds the requirements of this section must be adhered to.

		Maintenance Schedule				
	Hours:	150 (1st time only)	500 1000 1500 2500 3000	2000 6000 10000 14000 18000	4000 12000 20000	8000 16000
	Daily					
Coolant filter		Change		Change	Change	Change
Air filter **				Check pressure	Change	Change
Separator element ***				Check pressure	Change	Change
ULTRA COOLANT*	Check			Sample	Sample	Change
Power Drive Module filter *			Check	Change	Change	Change
Scavenge screen **				Check / clean	Check / clean	Check / clean
Hoses ***					Check / clean	Check / clean
High Air Temperature sensor			Check	Check	Check	Check
Pressure relief valve				Check	Check	Check
Cooler Core(s)			Check / clean	Check / clean	Check / clean	Check / clean
Moisture separator			Check / clean	Check / clean	Check / clean	Check / clean
Motor cowl			Check / clean	Check / clean	Check / clean	Check / clean
Vibration Analysis				Analysis	Analysis	Analysis
Coolant Analysis				Analysis	Analysis	Analysis
Food Grade Coolant *			Analysis at every 500 Change at every 1000			
Blower Motor / Fan Motor					Regrease	Regrease

If the compressor is run less than 4,000 hours per year,

HPM 250L motor Regrease at 2000hrs and 4000hrs N250/300H-2S only

* Maintain every 6 months

** Maintain every year

*** Maintain every 2 years

10.0 MAINTENANCE

Note:

On some sea watercooled models the oil cooler and aftercooler are fitted with sacrificial zinc anodes (pencils) that are located in the end bonnets of the coolers. These sacrificial zinc anodes should be checked after the **first 50 hours** of operation to determine if corrosive conditions exist. If satisfactory this interval may be extended to 500 hours.

NOTE:

1. If sacrificial zinc anode is 50% corroded it should be replaced.
2. Coastal/harbor waters can contain corrosive chemicals from pollution and may reduce anode/cooler life.
3. Effects of corrosion or erosion are specifically excluded from warranty considerations.

10.3 MAINTENANCE PROCEDURES

CAUTION

Before beginning any work on the compressor, read and understand the safety instructions earlier on in this manual. Open, lock and tag the main electrical disconnect and close the isolation valve on the compressor discharge. Do not under any circumstances open any drain valve or remove components from the compressor until this has been carried out. Ensure that all pressure has been vented from the compressor. Verify this by slowly unscrewing the coolant fill cap one turn. Unscrewing the fill cap opens a vent hole, drilled in the cap, allowing pressure to release to atmosphere. Do not remove the fill cap until all pressure has vented from the unit. Note that pipework downstream of the separator tank may still contain pressure that must also be vented to atmosphere before beginning any work.

CAUTION

When using any form of liquid for cleaning, ensure that all electrical components are protected or covered to prevent ingress of liquid.

WARNING

This compressor contains a variable frequency drive. When it is switched off and the motor is stopped, the internal capacitors store a potentially lethal high voltage. **DO NOT REMOVE THE DRIVE COVER** or attempt any work on the drive unless trained. There are no user serviceable items behind the cover.

DANGER

This compressor contains a variable frequency drive. When it is switched off and the motor is stopped, the internal capacitors store a potentially lethal high voltage electric charge which gradually falls to zero over time. After switching off the machine at its local isolator **WAIT AT LEAST 15 MINUTES** for the capacitors to fully discharge before opening the power drive module doors.

WARNING

The compressor can operate in a pressurised shutdown mode. If the compressor stops automatically, the airend, separator tank and oil system can contain high pressure air. This can be relieved by pressing the emergency stop button and can be verified by unscrewing the coolant fill plug which has a vent hole through which any residual pressure will be vented. Downstream of the separator tank may still contain system pressure which must also be vented.

WARNING

Use suitable equipment for lifting heavy items and ensure loose components are adequately supported to eliminate risk of dropping.

WARNING

The motor rotor contains a powerful magnetic field. This field can effect the operation of digital devices such as watches, mobile phones etc. Assembly or handling of the rotor should not be attempted by personnel with cardiac pacemakers, defibrillators or other implanted electronic medical device.

10.0 MAINTENANCE

Compressed air can be dangerous if incorrectly handled. Before doing any work on the unit, ensure that all pressure is vented from the system and that the machine cannot be started accidentally.

Ensure that maintenance personnel are adequately trained, competent and have read the Maintenance Manuals.

Prior to attempting any maintenance work, ensure that:–

- all air pressure is fully discharged and isolated from the system. If the automatic blowdown valve is used for this purpose, then allow enough time for it to complete the operation.
- the machine cannot be started accidentally or otherwise, by posting warning signs and/or fitting appropriate anti–start devices.
- all residual electrical power sources (mains and battery) are isolated.

Prior to opening or removing panels or covers to work inside a machine, ensure that:–

- anyone entering the machine is aware of the reduced level of protection and the additional hazards, including hot surfaces and intermittently moving parts.
- the machine cannot be started accidentally or otherwise, by posting warning signs and/or fitting appropriate anti–start devices.

Prior to attempting any maintenance work on a running machine, ensure that:–

- the work carried out is limited to only those tasks which require the machine to run.
- the work carried out with safety protection devices disabled or removed is limited to only those tasks which require the machine to be running with safety protection devices disabled or removed.
- all hazards present are known (e.g. pressurized components, electrically live components, removed panels, covers and guards, extreme temperatures, inflow and outflow of air, intermittently moving parts, safety valve discharge etc.).
- appropriate personal protective equipment is worn.
- loose clothing, jewelry, long hair etc. is made safe.
- warning signs indicating that Maintenance Work in Progress are posted in a position that can be clearly seen.

Upon completion of maintenance tasks and prior to returning the machine into service, ensure that:–

- the machine is suitably tested.
- all guards and safety protection devices are refitted.
- all panels are replaced, canopy and doors closed.
- hazardous materials are effectively contained and disposed of.

10.0 MAINTENANCE

10.4 ROUTINE MAINTENANCE

This section refers to the various components which require periodic maintenance and replacement.

For all other maintenance, contact your local Ingersoll Rand office, Distributor or Air Center.

Refer to safety information and maintenance procedures prior to carrying out any of the maintenance in the following sections.

Prior to starting

Coolant level checking procedure

The coolant level should be checked daily. A coolant level sight glass is located on the side of the separator tank and while the machine is running on load, coolant should always be visible in the sight glass. The normal position is half way.

Stop the machine and ensure coolant is still visible in the sight glass.

Adding coolant

Run the compressor for a minimum of 40 seconds, the coolant level should be visible in the sight glass. If not, stop the compressor, depressurize by isolating the compressor from the system, pressing the emergency stop to vent the separator tank & air end & then slowly unscrew the coolant fill plug to verify all pressure has been released and add coolant. Replace the coolant fill plug, restart the compressor and recheck the coolant level. Repeat until the coolant level is visible in the sight glass with the compressor both running and stopped.

Do not add coolant through the intake of the compressor, as this can result in overfilling, saturation of the separator filter element, and coolant carry-over downstream.

⚠ DANGER

Under no circumstance should the compressor be operated with the coolant fill plug removed.

Coolant change procedure

⚠ WARNING

The coolant filter and coolant may be hot!

The compressor features a 'no drip' coolant drain feature which requires no special tools and minimizes the risk of coolant spillage.

It is better to drain the coolant immediately after the compressor has been operating as the liquid will drain faster and any contaminant will still be in suspension

- Remove the cap from the drain valve located at the front of the separator vessel.
- Place a suitable container close to the drain valve.
- Screw the coolant drain hose onto the drain valve. As the threads engage, the valve will automatically open and the coolant will drain.
- Remove the drain hose. The valve will automatically close and seal.
- Replace the cap on the drain valve.
- For a complete drain, remove the plug near the vessel inlet flange and replace when complete.
- Replace the coolant filter element.
- Refill with correct quantity of coolant. See 8.0 General Information.

10.0 MAINTENANCE

Drain sequence for N250/300H–2S

- Remove plug from drain valve located on the bottom of the separator tank.
- Install supplied drain hose and fitting assembly in end of drain valve and place end of hose in a suitable pan.
- Open drain valve to start drainage.
- After draining is complete, close valve, remove hose and fitting assembly from valve, and store in a suitable location for future use.
- Replace plug in end of drain valve.
- Do not store drain hose in starter box after it has been used to drain the separator tank.

Coolant fill quantity
250–300 hp – 2 stage
40.0 gallons (152 liters)

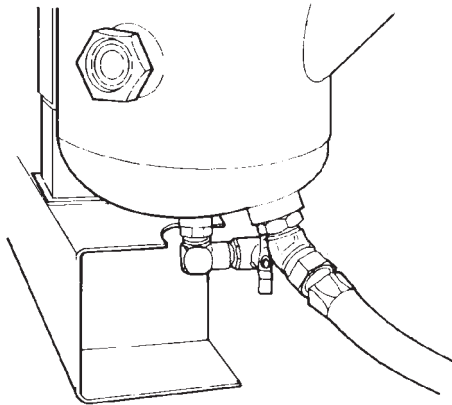

COOLANT DRAIN

CAUTION

Do not mix coolant types. Use only coolant specified by IR

- Start the compressor and check for leaks.
- Check the coolant level, refilling if necessary.
- Dispose of waste coolant in accordance with local and governmental regulations.

NOTICE

Shorter coolant drain intervals may be necessary if the compressor is operated in adverse conditions.

Food Grade Coolant option

- SSR Food Grade Coolant is a polyalphaolefin base coolant. Change after 1000 hours or every 6 months whichever comes first. Do not operate unit past this 1000 hour change interval, as coolant degradation will occur.

Coolant filter change procedure

- Loosen filter element with the correct tool.
- Remove the element from the housing.
- Place the old element in a sealed bag and dispose of in a safe way.
- Clean the mating face of the housing.
- Remove the new Ingersoll Rand replacement element from its protective package.
- Apply a small amount of coolant to the element seal.
- Screw the new element down until the seal makes contact with the housing, then hand tighten a further half turn.
- Start the compressor and check for leaks and check the coolant level.

Separator element checking procedure

With the compressor running on load, check the separator differential pressure via the Intellisys controller. It will be necessary to change the element if the differential pressure equals zero or exceeds 1 bar (12 psig).

Separator element change procedure

- Remove all the capscrews securing the cover to the tank except the screw opposite the pivot bolt which should be left engaged by 2–3 threads with at least 6.5mm (0.25") clearance from the screw head to the lid. Rotate the jacking bolt clockwise until the cover lifts off the tank at least 2mm (0.08") all the way around the tank. The cover can now be rotated to allow access to inside the tank.
- Carefully lift out the element spacer and retain for reassembly. Do not damage the flat surfaces of the spacer as this may cause higher oil carryover or leaks. A hoist is available for 175HP (90kW) machines and above if required.
- Carefully withdraw the used element, place it in a sealed bag and dispose of it safely.
- Remove the O-rings from the top of the tank, the separator element sealing face and the scavenge tube sealing face.
- Clean the surfaces on both the tank and the cover.
- Install new O-rings
- Install replacement element remembering to fit the small O-ring on the scavenge tube and positioning the tube into the matching hole in the Separator Tank
- Re-fit the separator element spacer with the notch over the scavenge tube.
- Rotate the tank cover back into position taking care not to damage the O-ring, and locate the cover using 2 capscrews but do not tighten down.

10.0 MAINTENANCE

Separator element change procedure for N250/300H-2S

- Disconnect the scavenge tube at the airend.
- Loosen the fitting that holds the scavenge tube into the tank and withdraw the tube assembly
- Disconnect the piping from the tank cover. Tag the lines if required.
- Use a suitable wrench and remove the bolts that hold the tank cover in position. Remove cover by lifting up and away.
- Carefully lift the separator element up and out of the tank. Discard the faulty element.
- Clean the gasket surface on both the tank and its cover. Exercise care to prevent pieces of the old gasket from falling down into the tank.
- Check the tank to be absolutely certain that no foreign objects such as rags or tools have been allowed to fall into the tank. Install replacement element down into the tank after checking the new element gaskets for possible damage. Center the element up within the tank.
- Place the tank cover in its correct position and install bolts. Tighten the bolts in a cross-pattern to prevent over-tightening one side of the cover. An improperly tightened cover will likely result in a leak.
- Tank cover bolt torque values
250-300 HP
3/4-10 UNC
210ft-lb. (285 n-M)
- Inspect tank scavenge screen and orifice. Clean if necessary following instructions in Section 4.7.
- Install scavenge tube down into the tank until the tube just touches the separator element and then raise it 1/8inch (3.2 mm). Tighten fittings.
- Install the regulation lines in their original position.
- Start unit, check for leaks, place in service.

RECOMMENDED BOLT TIGHTENING CROSS PATTERN

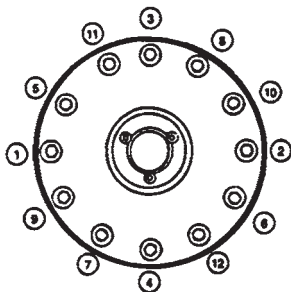

250 - 300 HP

Scavenge screen clean/check procedure

The screen/orifice assemblies are similar in appearance to a straight tubing connector and will be located between two pieces of 1/4 inch O.D. scavenge line tubing.

The main body is made from 1/2 inch hexagon shaped steel and the diameter of the orifice and a direction-of-flow arrow is stamped in flat areas of the hexagon.

A removeable screen and orifice is located in the exit end of the assembly. (see figure) and will require clearing as outlined in the Maintenance Schedule Section 10.2.

To remove the screen/orifice, disconnect the scavenge line tubing from each end. Hold the center section firmly and use a pair of pliers to gently grasp the exit end of the assembly that seals against the scavenge line tubing. Pull the end out of the center section while using care to prevent damage to the screen or sealing surfaces.

Clean and inspect all parts prior to reinstallation.

When the assembly is installed, confirm the direction of flow to be correct. Observe the small arrow stamped in the center section and ensure the direction flow to be from the separator tank to the airend.

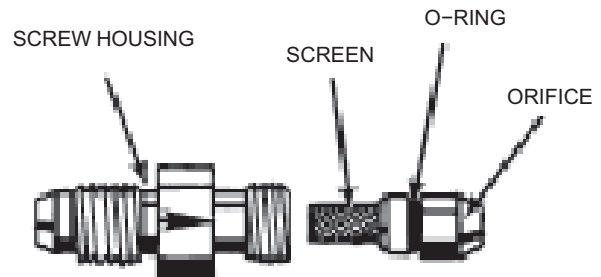

SEPARATOR TANK SCAVENGE SCREEN/ORIFICE

⚠ WARNING

Unscrew the jacking bolt sufficiently to ensure that the cover can be fully tightened down without imparting any stress onto the jacking points. Tighten down the cover setscrews.

- Start the compressor and check for leaks and coolant level.

⚠ CAUTION

Do not use any form of sealant on either the separator tank or the separator tank cover faces.

Separator tank / Pressure system

At 2000 hour intervals, inspect the external surfaces of the airend and separator tank, including all fittings, for visible signs of impact damage, excessive corrosion and abrasions. When changing the separator element inspect the internal components and surfaces. Any suspect parts should be replaced before the compressor is put back into service.

The separator tank should also be tested and inspected in accordance with any national or local codes that may exist.

10.0 MAINTENANCE

Blower motor Re-Grease

(N75-160 Aircooled units)
6 Months or 4000 Hrs

Apply high melting point grease into the blower motor drive end bearing using a grease gun at the nipple provided.

Stop when excess grease is seen at the relief port.

Main motor Re-Grease instructions

HPM 250L motor Re-Grease (N250/300N-2S units only)
Every 2000 hours

Apply Exxon Polyrex - EM or Mobilith - CHC 220 grease into main motor drive end and non-drive end bearings using a grease gun at the nipple provided.

Drive end and non-drive end grease quantity 75 grams.

Stop when excess grease is seen at the relief port.

Coolant hoses

- The flexible hoses that carry coolant through the cooling system may become brittle with age and will require replacement. Have your local Ingersoll Rand Distributor or Air Center inspect them every 3 months and replace them as needed or every 2 years.
- Depending on the location of the hose, it may contain compressor coolant. It is recommended to drain the coolant into a clean container. Cover the container to prevent contamination. If the coolant is contaminated, a new charge of coolant must be used.
- Remove the hose.
- Install the new hose and refill the unit with coolant. Start the compressor, check for leaks and check coolant level. Refill as necessary

Pressure relief valve check

The pressure relief valve must be frequently tested and regularly maintained. Remove from the machine and check for the correct operating pressure. Adjust as necessary. If operating conditions are particularly severe, the frequency of testing and maintenance must be increased accordingly. A pressure relief valve check must also be performed at the end of any non-service period. The user must establish the frequency of such tests as it is influenced by such factors as the severity of the operating environment.

CAUTION

High pressure air will discharge through the discharge ports of the valve during pressure relief valve check. Wear ample clothing, gloves, safety glasses and ear protection during valve testing.

Run the compressor for about 10 minutes by venting air from the system to let the unit warm up. With the unit running, test at or near the maximum operating pressure by opening the valve for the minimum period required to flush the valve seat free of debris. This can be accomplished by holding the test lever fully open or unscrewing the spring pressure retaining cap, depending on the type of valve installed. If there is no evidence of discharge or the valve does not fully close, discontinue use of equipment and contact a licensed contractor or qualified service personnel.

The pressure relief valve should also be tested and re-calibrated in accordance with any national or local codes that may exist. If no code exists, IR recommend that the pressure relief valve is recalibrated at intervals of one year.

Air filter change procedure

- Unclip the retaining cap and withdraw the old element.
- Fit the new element and refit the retaining cap.

Air filter change procedure N250/300H-2S

- Loosen wing nut on top of inlet filter housing. Lift cover up and away to expose elements.
- Carefully remove the old element to prevent dirt from entering the the compressor inlet.
- Thoroughly clean the element housing and wipe all surfaces
- Install new element and inspect to ensure that they have seated properly.
- Install top of inlet filter housing.
- Inspect the rubber seal on the retainer wing nut and replace seal if required.
- Tighten wing nuts.

Aircooled Cooler Cleaning

Ensure that the compressor is isolated from the compressed air system and is vented of all pressure. When undertaking any work on the compressor always use certified lifting equipment and employ sound working principles.

Ensure that the main power disconnect switch is locked off and tagged.

Visually check the outside of the cooler cores to be certain that a complete cleaning of the cooler is required. Frequently, dirt, dust or other foreign material may only need to be removed with a vacuum to remedy the problem.

When the cooler is covered with a combination of oil, grease or other heavy substances that may affect the unit's cooling, then it is recommended that the cooler cores be thoroughly cleaned on the outside.

If it is determined that the compressor operating temperature is higher than normal due to the external passages between the fins of the cooler cores being restricted with deposits of foreign material, then the cooler should be removed for cleaning.

10.0 MAINTENANCE

N50/100H (N37/75K)

Following are instructions for tilting the cooler away from the enclosure and cleaning of the cooler.

- Remove 6 screws from lower rear fixed panel and remove panel.
- Remove 10 screws from the rear intake panel and remove panel.
- Loosen clamp and disconnect the air inlet hose from the intake plenum.
- Remove intake plenum. **Note, plenum is unsupported, before removing the 8 screws from the intake plenum, block underside of plenum prior to removing screws to prevent plenum from falling.**
- Remove hose from elbow in aftercooler inlet. Plug elbow in inlet hole of aftercooler.
- Unscrew the fitting connecting the aftercooler to the discharge tube.
- Loosen mounting bolts on moisture separator to allow moisture separator to slide down in mounting bracket. Once lowered, remove the discharge tube connecting the moisture separator to the aftercooler outlet.
- Plug aftercooler discharge hole.
- To tilt cooler forward, remove 6 screws holding the cooler in place. **While removing the last screw, hold the top of the cooler in place to prevent the cooler from tilting.** Once the screw is removed, allow the cooler to tilt forward until the pivot brackets touch the pivot stops. The cooler will stop tilting at 45 degrees.
- Cover the main drive motor with plastic sheeting to prevent cleaning solution from entering the motor.
- Before cleaning coolers, check to ensure aftercooler intake and discharge holes are plugged to prevent contamination of compressor system. Clean coolers with a mild cleaning solution.

WARNING

Strong cleaners can harm aluminium cooler parts. Follow cleaner manufacturers instructions for use. Wear appropriate safety equipment.

- After cleaning is complete, reassemble in reverse order.

N125/200H (N90/160K) SINGLE STAGE and N100/200H (N75K-160K) TWO STAGE

The coolers in these machines can either be cleaned by removing the complete cooler for off site cleaning or 'back flushing' in place using a high pressure hose and gaining access through the holes in the intermediate plenum.

Instructions for cleaning the coolers while installed in the compressor.

While cleaning coolers, great care must be taken to protect the rest of the machine from moisture and contamination by covering sensitive parts with plastic sheeting.

- Remove 4 screws from enclosure panel below moisture separator and remove panel.
- Remove 4 screws from enclosure panel above moisture separator and remove panel.
- Remove the 16 screws securing the access panels on the cooling plenum and remove covers.
- Cover main drive motor, PDM Heat sink blower motor, drain valve, and cooling motor variable speed drive with plastic sheeting to prevent damage from entrance of cleaning solution.
- Cover inlet of blower wheel with plastic sheeting to prevent entrance of cleaning fluid.
- Cover the inlet grill of the intake panel with plastic sheeting to prevent cleaning solution from exiting the compressor.
- Attach drain hose to the coupling on the bottom of the plenum to allow the cleaning solution to drain outside the compressor. Alternately, place large bucket underneath plenum to collect cleaning fluid.
- Use an extended length nozzle and a mild cleaning solution to clean the coolers.

WARNING

Strong cleaners can harm aluminium cooler parts. Follow cleaner manufacturers instructions for use. Wear appropriate safety equipment.

- Cleaning fluid will collect on both sides of the cooler core. If required, periodically drain fluid from intake plenum and bucket to prevent them from overflowing.
- After cleaning is complete, dry off plenum, intake, and cooler core. Reassemble parts in reverse order.

If the cooler cores are unable to be cleaned while installed in the compressor, remove cooler as follows:

- Remove 5 screws from panel below the intake panel and remove panel. Be careful not to damage the electrical leads entering the panel.
- Remove 8 screws from the intake panel and remove panel.
- Remove 8 screws from the intake plenum supports and remove the supports.
- Remove the 10 screws securing the intake plenum and remove the plenum
- Disconnect both oil lines and both air lines from the cooler. Plug all 4 inlets to prevent cleaning fluid from entering the cooler cores.

10.0 MAINTENANCE

- Remove 6 screws from top panel above cooler and remove panel.
- Using lifting device from above, attach lifting straps to lifting supports on each side of cooler.
- With the weight of the cooler supported by the lifting device, remove the 10 screws securing the cooler and remove the cooler.
- Clean coolers with a mild cleaning solution.

⚠ WARNING

Strong cleaners can harm aluminium cooler parts. Follow cleaner manufacturers instructions for use. Wear appropriate safety equipment.

- After cleaning is complete, reassemble in reverse order.

N250/300H–TWO STAGE

COOLANT COOLERS

- Following are instructions for removal and internal cleaning of coolant coolers.
- Remove panels and top cover.
- Drain the coolant. See Section 4.6.
- Remove side panels from coolant cooler box.
- Disconnect piping from coolant cooler inlet and outlet ports.
- Plug cooler inlet and outlet ports to prevent possible contamination.
- Remove coolant cooler holding screws from sides of coolant cooler and remove cooler through side of cooler shroud.
- It is recommended the cooler be taken to a professional cooler service shop for flushing with an appropriate environmentally safe cleaning agent.
- Reassemble in reverse order.
- Make sure fan guards are replaced.
- Refill the compressor with coolant. If contamination is suspected, replace with new coolant.
- Replace fill plug.
- Run compressor for ten minutes. Check for possible leaks. Check coolant level.
- Replace enclosure panels.

⚠ WARNING

Strong cleaners can harm aluminum cooler parts. Follow cleaner manufacturer's instructions for use. Wear appropriate safety equipment.

AFTERCOOLER

- Following are instructions for the removal and internal cleaning of aftercoolers.

- Disconnect hose from aftercooler inlet flange.
- Disconnect tube from aftercooler outlet flange.
- Remove aftercooler holding screws from aftercooler support and remove cooler.
- It is recommended the cooler be taken to a professional cooler service shop for flushing with an appropriate environmentally safe cleaning agent.
- Reassemble in reverse order.
- Replace enclosure panels.

Watercooled Cooler Cleaning

A periodic inspection and maintenance program should be implemented for watercooled heat exchangers. The following steps should be taken:

- Inspect filters in system and replace or clean as required.
- Carefully examine cooler tubes for scale and clean if necessary. If a cleaning solution is used, be sure to wash out all chemicals thoroughly with clean water before returning the compressor to service. After cleaning, examine the cooler for erosion or corrosion.
- The internal cooler tubes can be cleaned by several methods. Flushing a high velocity stream of water through the tubes will remove many forms of deposits. More severe deposits may require running wire brushes or rods through the tubes. Also, rubber plugs can be forced through the tubes if a special air or water gun is available for this procedure.
- A qualified cleaning service should be used for the cleaning process. These organizations can evaluate the type of deposit to be removed and supply the appropriate solution and method for a complete cleaning job.
- When reinstalling bonnets to cooler shell, tighten bolts uniformly in a cross-pattern. Overtightening can result in cracking of the bonnet.
- Cleaning solutions must be compatible with the metallurgy of the cooler
- Care must be taken to avoid damaging tubes if mechanical cleaning procedures are used.

Airend bearings

Airend bearings are lubricated by the compressor coolant and require no maintenance.

High Airend Temperature Sensor checking procedure

It is recommended that the discharge temperature sensor (2ATT) is checked regularly as follows:

Aircooled machines

Stop the cooling blower by opening the blower / fan motor circuit breaker.

10.0 MAINTENANCE

Watercooled machines

Shut off the cooling water.

The machine should trip at 109° C (228° F).

⚠ CAUTION

Under no circumstances should these discharge temperatures be exceeded. If the machine fails to trip A FAULT EXISTS. Investigate immediately.

Separator tank scavenge check valve/orifice

- Disconnect tubing at each end of check valve/ screen/ orifice assembly.
- Check orifice and clean if required. Use suitable tool and remove orifice from its housing. Be careful not to damage flared end of fitting or O-ring. Wash housing in safety solvent and blow dry.
- Press the check valve/orifice into fitting block.
- Assemble the check valve/orifice assembly to the tubing lines. The fitting must be re-installed with the check valve on the upstream side of the orifice as indicated by the flow arrow.

Blower / fan Motor Bearing Maintenance (Stored units)

- Prior to placing a unit in storage for extended intervals, rotate the blower motor several revolutions by hand in the direction of rotation.
- On N75 – 160, N250 – 300H aircooled units, whilst rotating the motor, pump grease into the bearing until grease is seen at the relief port.
- Thereafter rotate the motor as described above every three months until such time as the unit is placed in service.
- If the storage time is to exceed a total of nine (9) months duration, the compressor must be ordered for long term storage.

Motor cowl cleaning N75–160 units only

- Ensure compressor is electrically isolated for at least 15 minutes before commencing any maintenance work.
- Remove panels from the compressor.
- Using a clean dry cloth, remove dust from the surface of the motor cowl and ensure all ventilation slots are free of obstructions.
- Replace panels to the compressor.

Drive Box Filter Removal / Replacement

- Ensure compressor is electrically isolated for at least 15 minutes before commencing any maintenance work.
- Unclip the front grill of the drive box filter.

- Remove the filter pad from the housing and replace with a new filter pad from Ingersoll Rand.
- Replace front grill to the drive box filter.

Moisture Separator Check / Cleaning

- Ensure compressor is electrically isolated for at least 15 minutes, before commencing any maintenance work.
- Isolate the compressor from the system and fully discharge the compressed air within the unit.
- Remove plastic tube from the fitting located on the bottom of the moisture separator.
- Remove the bowl of the moisture trap, clean and replace.

Condensate (Moisture) Drain Valve / Trap

- Ensure compressor is electrically isolated for 15 minutes and all pressure is relieved from system.
- Remove all pipes going to and from the valve (or trap).
- Disconnect any electrical cables to the valve (or trap).
- Determine the type of condensate drain device and continue in the appropriate section below:–

Timed Solenoid Drain Valves (where fitted) Check / Cleaning

- Remove the central nut and then the electrical coil.
- Remove screws holding bonnet of valve and carefully split the valve. Clean and inspect all internal parts.
- Similarly check and clean the ball valve and needle valve.
- Replace any defective parts as identified in parts manual.
- Re-assemble and later, with machine running, check that condensate and air is expelled at frequency and duration set into the INTELLISYS controller (see section 9.6).

10.0 MAINTENANCE

No Loss Drain Trap (where fitted) Check / Cleaning

- Remove the four socket head screws then carefully split the trap. Clean and inspect all internal parts with particular attention to the water level sensor(s).
- If the stainless steel strainer mesh is blocked, remove it and clean in a weak detergent solution.
- Replace any defective parts (see parts manual for repair kit).
- Re-assemble and later, with machine running, check that condensate is expelled at regular period and no alarms are signaled on trap or on INTELLISYS display.

Fluid and Vibration Monitoring

Ingersoll Rand recommends incorporating predictive maintenance, specifically the use of coolant and vibration analysis, into all Preventative Maintenance programs. Predictive Maintenance is designed to increase system reliability and prevent costly downtime. Through the use of sophisticated diagnostic tools, including fluid, vibration, and optional air analysis, IR Certified Service Technicians can identify and correct potential problems BEFORE they can cause expensive unscheduled downtime.

How does predictive analysis work? By establishing an initial baseline for normal operation, and then regularly monitoring fluid and vibration conditions, any sudden deviation or significant increase from this baseline can be identified and investigated to pinpoint the cause. More quickly diagnosing potential problems can directly save money by preventing costly failures and reducing or eliminating downtime. In addition, regular condition monitoring also helps to maximize the time between expensive preventative maintenance intervals, such as component rebuilds and coolant changes.

Coolant Sampling Procedure

Bring unit up to operating temperature. Draw sample, using pump kit, from separator tank port. DO NOT draw sample from drain port or oil filter. Use a new hose on pump for each sample, failure to do this can give false readings.

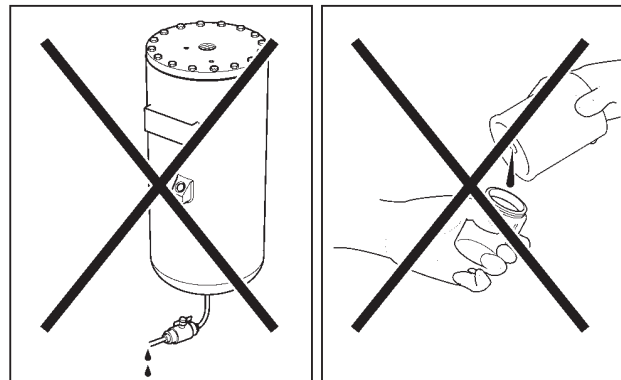
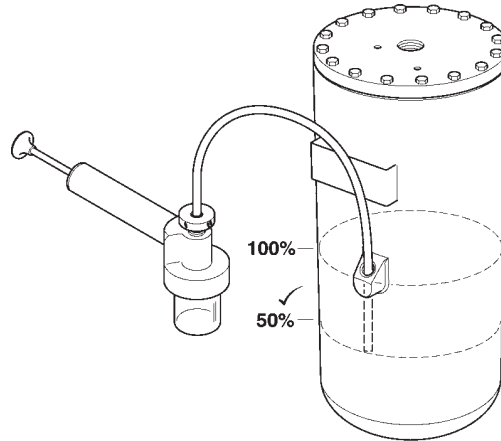

TS660
Revision 00
12/02

11.0 FAULT FINDING

11.1 GENERAL FAULTS

⚠ WARNING

When attempting to identify and remedy any fault or failure, ensure it is only attempted by qualified personnel and that the safety and maintenance sections of this manual have been read and are fully understood and followed. Major overhauls should only be carried out by a qualified Ingersoll Rand representative. Failures caused by fitting parts not recommended by Ingersoll Rand or non-authorized Ingersoll Rand personnel may not be covered by the terms of any warranty agreement

SYMPTOM	FAULT	REMEDY
Compressor will not start	No power supply to package	Check supply is switched on. If so, contact a qualified electrician.
	Intellisys controller failure	Check supply to unit. Replace unit.
	Starter failure	Isolate supply, lock off and tag. Replace failed component or contact your local Ingersoll Rand representative
Compressor stops and will not restart	Drive controller has tripped	See section 11.2 & 11.3
	Intellisys controller has tripped the compressor	See section 11.2 & 11.3
	Maximum number of starts per hour exceeded	
Compressor is stopped and will not restart	Intellisys controller has tripped the compressor and has not been reset	See section 11.2 & 11.3
	Emergency stop has been pressed and not released	Identify reason why, repair fault, disengage button and reset Intellisys controller
	Emergency stop has been pressed and released but Intellisys controller has not been reset	Repair fault and reset Intellisys controller

11.0 FAULT FINDING

SYMPTOM	FAULT	REMEDY
Compressor will not meet pressure required by system	Compressor not sized to meet system requirements or requirements have been changed.	Contact your local IR representative
	Air loss due to pipe, hose, joint or seal failure	Overhaul or replace
	Air loss due to blowdown valve stuck open	Overhaul or replace
	Air loss through pressure relief valve not seating or set incorrectly	Overhaul or replace
	Air loss due to moisture separator drain trap stuck open	Overhaul or replace
	Motor speed too low caused by drive incorrectly set	Contact your local IR representative
	Motor speed too low caused by fault in drive settings	See section on drive faults
	Intellisys controller fault	Overhaul or replace
	Drive motor fault	See section on drive faults
	Pressure transducer faulty, incorrectly calibrated or EMF interference	Recalibrate or replace
	Incorrect Intellisys controller settings	Check and modify settings
	Inlet grill or ducting is blocked	Check and clean
	Air filter dirty or collapsed	Replace
	Inlet valve not opening fully	Overhaul or replace
	Separator element dirty or collapsed	Replace
	Pipe / Hoses blocked or collapsed	Clean or replace
	Cooler core blocked	Clean or replace
	Minimum pressure check valve not functioning correctly	Overhaul or replace
Equipment between compressor and customer measuring point causing pressure drop / pressure loss	Review system requirements	

11.0 FAULT FINDING

SYMPTOM	FAULT	REMEDY
Pressure produced by compressor is too high/compressor is too high due to speed not reducing as demand reduces	Intellisys set incorrectly	Check and modify settings
	Pressure transducer may be faulty, incorrectly calibrated or not receiving pressure signal	Recalibrate or replace
	Drive settings fault	Contact your local IR representative
Compressor discharge air too hot	High ambient temperature	Review installation and system parameters
	Insufficient cooling air	Check ducting and cooling air path, check direction of blower rotation
	Blocked aftercooler matrix	Clean or replace
Compressor package produces excessive noise	Panels or doors are not closed properly	Rectify fault
	Air leaks from internal pipework / components	Overhaul or replace
	Blower or blower motor bearings worn	Overhaul or replace
	Loose debris impacting on blower during rotation	Remove and rectify any damage
	Blowdown valve stuck open	Overhaul or replace
	Pressure relief valve not seating correctly	Overhaul or replace
	Vibration due to motor, airend or blower imbalance	Overhaul or replace
	Airend requires overhaul	Contact your local IR representative
Discharge air is contaminated with coolant	Scavenge pipe is blocked, broken or o-ring is not sealing	Clean or replace
	Separator element is punctured, or incorrect, or requires changing, or not sealing correctly	Replace
	Incorrect coolant has been added	Drain system, check for damage. Clean, refill with correct coolant.
	System has been overfilled with coolant	Check for damage, drain excess.

11.0 FAULT FINDING

SYMPTOM	FAULT	REMEDY
Discharge air is contaminated with condensate	Aftercooler not functioning correctly	Clean or replace
	Moisture separator drain trap faulty	Overhaul or replace
	Continuous low speed / low ambient operation causing condensate build up	Review system requirements and contact your local IR representative
Compressor package draws too much current	Compressor operating above rated pressure	Check and modify settings. Review system requirements and contact your local IR representative
	Separator filter element dirty or blocked	Replace
	Voltage supply is low or unbalanced	Contact your local IR representative or a qualified electrician
	Airend is damaged	Contact your local IR representative
Excessive coolant consumption	Coolant system leak	Overhaul or replace
	See also 'discharge air is contaminated with coolant'	See above

11.2 INTELLISYS FAULTS (INDICATED ON THE INTELLISYS CONTROLLER)

FAULT	CAUSE	REMEDY
Emergency Stop	Emergency stop button has been pressed.	Identify reason why, repair fault, disengage button and reset Intellisys controller
Blower motor overload	Blower is blocked, damaged or blower motor is faulty.	Remove blockage, repair or replace damaged components
High airend discharge temperature	Compressor operating above rated pressure	Check and modify settings. Review system requirements and contact your local IR representative
	Low coolant level	Check for leaks. See also 'discharge air is contaminated with coolant'. Top up coolant.
	High ambient temperature	Review installation and system parameters
	Insufficient cooling air	Check ducting and cooling air path.
	Blocked coolant cooler matrix	Clean or replace
	Blower motor direction of rotation incorrect	Wire correctly
Check setpoints	Controller software has been changed	Recalibrate all sensors and check setpoints

11.0 FAULT FINDING

FAULT	CAUSE	REMEDY
Remote start failure	Remote start button is pressed after machine is running or remote start button remains closed.	Check operation of buttons or operating procedures
Remote stop failure	Remote stop button remains open and either start button is pressed	Check operation of buttons or operating procedures
Sensor failure	Sensor is missing or faulty	Install, repair or replace faulty sensor
Compressor trips indicating a high compressor temperature.	Insufficient cooling taking place	If machine is watercooled or sea watercooled, check that the cooling water is flowing. Check that there is no air in the water cooling system. Check that the strainer is not blocked.
Intellisys controller has tripped the compressor	A fault has occurred	Repair fault / reset Intellisys controller
Invalid Calibration	Calibration done with pressure in compressor.	Depressurise and re calibrate with pressure pipe to sensor disconnected. If fault still exists, replace pressure transducer.
Low sump pressure	System leak	Located and repair
	Minimum pressure check valve faulty	Repair with service kit
	Blowdown valve faulty	Repair with service kit
	Loss of control power	Check 110V circuit breaker Check wiring Check contactor KM1
Check motor rotation	Drive system fault	Contact your local IR representative
VSD communication failure	Communication wiring faulty	Check and replace if required
	Drive faulty	Contact your local IR representative
	Intellisys faulty	Contact your local IR representative
VSD initialisation fault	Communication wiring faulty	Check and replace if required
	Drive faulty	Contact your local IR representative
	Intellisys faulty	Contact your local IR representative

11.0 FAULT FINDING

11.3 DRIVE FAULTS (INDICATED ON THE INTELHYS CONTROLLER)

The drive controller is directly linked to the Intellisys controller. Faults in the drive controller will be displayed on the Intellisys controller as 'VSD fault 0, VSD fault 1' etc.

The following VSD faults may be investigated and remedied at source. For all other VSD faults, contact your local IR customer support representative.

FAULT	CAUSE	ACTION
VSD Fault 1	Over-current	Check separator element. Check cooler, pipework and moisture separator for blockages. Check operation of minimum pressure check valve.
VSD Fault 3	Drive temperature too high	Check drive filter, replace if necessary Check drive cooling fan circuit breaker Check wiring



A series of horizontal lines for writing, spanning the width of the page. The lines are evenly spaced and extend from the left margin to the right edge of the page. There are 25 lines in total, starting from the top margin and ending at the bottom margin.



A series of horizontal lines for writing, spanning the width of the page. The lines are evenly spaced and extend from the left margin to the right margin. There are 25 lines in total, starting from the top margin and ending at the bottom margin.