

# OWNER'S/ OPERATOR'S MANUAL

## MODEL NO.'s

**GLB-2200**

**GLB-3000**

**GLB-330**

**GLB-340**

### **CAUTION**

For Safe Operation  
Read Rules And  
Instructions Carefully

SINO LEEINGLES, PIDA AYUDA  
A AIGUIEN QUE SI LO LEA  
PARA QUE LE TRADUZCA LAS  
MEDIDAS DE SEGURIDAD.

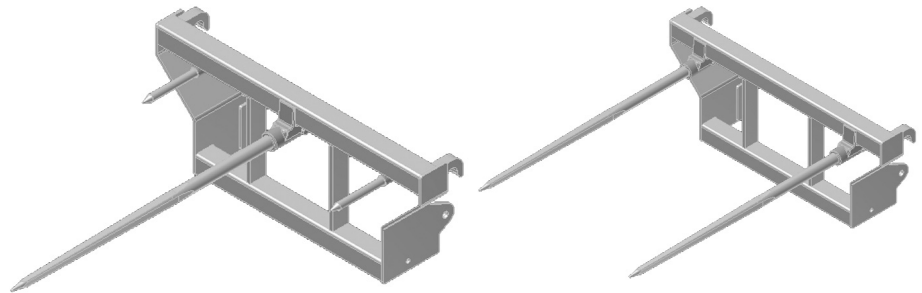

**GLB-2200**

**GLB-3000**

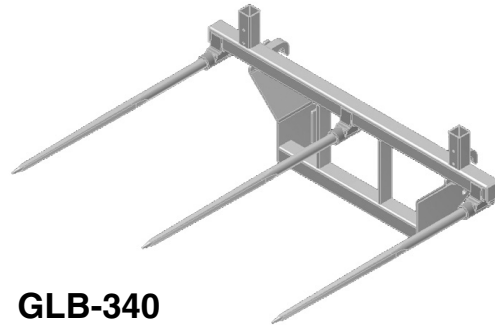

**GLB-340**

## **GLOBAL/EURO-HOOK STYLE INTEGRATED DESIGN BALE SPEAR ATTACHMENTS**

**Safety Instructions  
Assembly & Mounting  
Operating Instructions**

**Maintenance  
Repair Parts**

### **CAUTION**

#### **THE FOLLOWING SAFETY PRECAUTIONS SHOULD BE THOROUGHLY UNDERSTOOD BEFORE ATTEMPTING TO BEGIN ASSEMBLING THIS MACHINE**

1. Select an area for assembly that is clean and free of any debris which might cause persons working on the assembly to trip.
2. Do not lift heavy parts or assemblies. Use crane, jack, tackle, fork trucks or other mechanical devices.
3. Preview the assembly instructions in your operator's manual before proceeding further.
4. If the assembly instructions call for parts or assemblies to be blocked up, use only blocking material that is in good condition and is capable of handling the weight of the assembly to be blocked. Also insure that the blocking material is on a clean, dry surface.
5. Never put hands, or any part of body, under blocked up assemblies if at all possible.
6. After completing assembly, thoroughly inspect the machine to be sure that all nuts, bolts, hydraulic fittings or any other fastened assemblies have been thoroughly tightened.
7. Before operating the machine, thoroughly read the operation section of your operator's manual.
8. Before operating, read the maintenance section of your operator's manual to be sure that any parts requiring lubrication, such as gearboxes, are full, to avoid any possible damage.
9. **Before operating equipment – If you have any questions regarding the proper assembly or operation, contact your dealer or representative.**

# TABLE OF CONTENTS

WARRANTY .....	2
SAFETY INFORMATION .....	3
SAFETY SIGNS .....	13
PREPARATION INSTRUCTIONS .....	14
OPERATING INSTRUCTIONS .....	15
OWNER SERVICE .....	18
PARTS LISTS .....	19 - 23

SINO LEEINGLES, PIDA AYUDA A AIGUIEN QUE SI LO LEA PARA QUE LE TRADUZCA LAS MEDIDAS DE SEGURIDAD.

## STATEMENT OF POLICY

It is the policy of Worksaver, Inc. to improve its products where it is possible and practical to do so. Worksaver, Inc. reserves the right to make changes or improvements in design and construction at any time, without incurring the obligation to make these changes on previously manufactured units.

## TO THE OWNER:

Read this manual before using your Bale Spear Attachment. This manual is provided to give you the necessary operating and maintenance instructions for keeping your Bale Spear Attachment in top operating condition. Please read this manual thoroughly. Understand what each control is for and how to use it. Observe all safety signs on the machine and noted throughout the manual for safe operation of implement. Keep this manual handy for ready reference.

Like all mechanical products, it will require cleaning and upkeep.

Use only genuine Worksaver, Inc. service parts. Substitute parts will void the warranty and may not meet standards required for safe and satisfactory operation. Record the model and serial number of your Attachment here:

Model: \_\_\_\_\_ Serial Number: \_\_\_\_\_

---

---

## RETAIL CUSTOMER'S RESPONSIBILITY

**It is the Retail Customer and/or Operator's responsibility to read the Operator's Manual, to operate, lubricate, maintain, and store the product in accordance with all instructions and safety procedures. Failure of the operator to read the Operator's Manual is a misuse of this equipment.**

**It is the Retail Customer and/or Operator's responsibility to inspect the product and to have any part(s) repaired or replaced when continued operation would cause damage or excessive wear to other parts or cause a safety hazard.**

**It is the Retail Customer's responsibility to deliver the product to the authorized Worksaver Dealer, from whom he purchased it, for service or replacement of defective parts which are covered by warranty. Repairs to be submitted for warranty consideration must be made within forty-five (45) days of failure.**

**It is the Retail Customer's responsibility for any cost incurred by the Dealer for traveling to or hauling of the product for the purpose of performing a warranty obligation or inspection.**

# LIMITED WARRANTY



Worksaver warrants to the original purchaser of any new Bale Spear Attachment, that the equipment be free from defects in material and workmanship for a period of six (6) months for non-commercial, state, and municipalities. Use sixty (60) days for commercial use from date of retail sale.

Replacement or repair parts installed in the equipment covered by this warranty are warranted for ninety (90) days from the date of purchase of such part or to the expiration of the applicable new equipment warranty period, whichever occurs later.

Such parts shall be provided at no cost to the user during regular working hours. Worksaver reserves the right to inspect any equipment or parts which are claimed to have been defective in material or workmanship.

## DISCLAIMER OF IMPLIED WARRANTIES & CONSEQUENTIAL DAMAGES

Worksaver's obligation under this warranty, to the extent allowed by law, is in lieu of all warranties, implied or expressed, including implied warranties of merchantability and fitness for a particular purpose and any liability for incidental and consequential damages with respect to the sale or use of the items warranted. Such incidental and consequential damages shall include but not be limited to: transportation charges other than normal freight charges; cost of installation other than cost approved by Worksaver; duty; taxes; charges for normal service or adjustments; loss of crops or any other loss of income; rental of substitute equipment, expenses due to loss, damage, detention or delay in the delivery of equipment or parts resulting from acts beyond the control of Worksaver.

## THIS WARRANTY SHALL NOT APPLY:

1. To vendor items which carry their own warranties, such as hydraulic cylinders, tires, and tubes.
2. If the unit has been subjected to misapplication, abuse, misuse, negligence, fire or other accident.
3. If parts not made or supplied by Worksaver have been used in connection with the unit, if, in sole judgement of Worksaver such use affects its performance, stability, or reliability.
4. If the unit has been altered or repaired outside of an authorized Worksaver dealership in a manner which, in the sole judgement of Worksaver affects its performance, stability or reliability.
5. To normal maintenance service and normal replacement items such as gearbox lubricant, hydraulic fluid, worn blades, or to normal deterioration of such things as belts and exterior finish, due to use or exposure.
6. To expendable or wear items such as teeth, chains, sprockets, belts, springs and other items that in the company's sole judgement is a wear item.

NO EMPLOYEE OR REPRESENTATIVE OF WORKSAVER IS AUTHORIZED TO CHANGE THIS WARRANTY IN ANY WAY OR GRANT ANY OTHER WARRANTY UNLESS SUCH CHANGE IS MADE IN WRITING AND SIGNED BY WORKSAVER'S SERVICE MANAGER, POST OFFICE BOX 100, LITCHFIELD, ILLINOIS 62056-0100.



# To the Owner/Operator/Dealer

All implements with moving parts are potentially hazardous. There is no substitute for a cautious, safe-minded operator who recognizes the potential hazards and follows reasonable safety practices. The manufacturer has designed this implement to be used with all its safety equipment properly attached to minimize the chance of accidents.

## BEFORE YOU START!!

**Read the safety messages on the implement and shown in your manual.  
Observe the rules of safety and common sense!**



**THIS SYMBOL MEANS**

- ATTENTION!
- BECOME ALERT!
- YOUR SAFETY IS INVOLVED!

THIS SAFETY ALERT SYMBOL IDENTIFIES IMPORTANT SAFETY WARNING MESSAGES. CAREFULLY READ EACH WARNING MESSAGE THAT FOLLOWS. FAILURE TO UNDERSTAND AND OBEY A SAFETY WARNING, OR RECOGNIZE A SAFETY HAZARD, COULD RESULT IN AN INJURY OR DEATH TO YOU OR OTHERS AROUND YOU. THE OPERATOR IS ULTIMATELY RESPONSIBLE FOR THE SAFETY OF HIMSELF, AS WELL AS OTHERS, IN THE OPERATING AREA OF THE TRACTOR AND ATTACHED EQUIPMENT.

---

## UNDERSTAND SIGNAL WORDS

Note the use of the signal words **DANGER**, **WARNING** and **CAUTION** with the safety messages. The appropriate signal word for each has been selected using the following guidelines:

**DANGER:** Indicates an imminently hazardous situation that, if not avoided, will result in death or serious injury. This signal word is to be limited to the most extreme situations typically for machine components which, for functional purposes, cannot be guarded.

**WARNING:** Indicates a potentially hazardous situation that, if not avoided, could result in death or serious injury, and includes hazards that are exposed when guards are removed. It may also be used to alert against unsafe practices.

**CAUTION:** Indicates a potentially hazardous situation that, if not avoided, may result in minor or moderate injury. It may also be used to alert against unsafe practices.

If you have questions not answered in this manual or require additional copies or the manual is damaged, please contact your dealer or the manufacturer directly.

---

## IMPORTANT SAFETY INFORMATION!

Working with unfamiliar equipment can lead to careless injuries. Read this manual, and the manual for your tractor, before assembly or operating, to acquaint yourself with the machines. It is the implement owner's responsibility, if this machine is used by any person other than yourself, is loaned or rented, to make certain that the operator, prior to operating:

1. Reads and understands the operator's manuals.
2. Is instructed in safe and proper use.













The use of this equipment is subject to certain hazards which cannot be protected against by mechanical means or product design. All operators of this equipment must read and understand this entire manual, paying particular attention to safety and operating instructions, prior to using. If there is something in this manual you do not understand, ask your supervisor, or your dealer, to explain it to you.

# SAFETY INSTRUCTIONS (continued)







## EQUIPMENT SAFETY GUIDELINES

-  Safety of the operator is one of the main concerns in designing and developing a new piece of equipment. Designers and manufacturers build in as many safety features as possible. However, every year many accidents occur which could have been avoided by a few seconds of thought and a more careful approach to handling equipment. You, the operator, can avoid many accidents by observing the following precautions in this section. To avoid personal injury, study the following precautions and insist those working with you, or for you, follow them.
  
-  In order to provide a better view, certain photographs or illustrations in this manual may show an assembly with a safety shield removed. However, equipment should never be operated in this condition. Keep all shields in place. If shield removal becomes necessary for repairs, replace the shield prior to use.
  
-  Replace any CAUTION, WARNING, DANGER or instruction safety sign that is not readable or is missing. Location of such safety signs is indicated in this booklet.
  
-  Never use alcoholic beverages or drugs which can hinder alertness or coordination while operating this equipment. Consult your doctor about operating this machine while taking prescription medications.
  
-  Review the safety instructions with all users annually.
  
-  This equipment is dangerous to children and persons unfamiliar with its operation. The operator should be a responsible adult familiar with farm machinery and trained in this equipment's operations. **Do not allow persons to operate or assemble this unit until they have read this manual and have developed a thorough understanding of the safety precautions and of how it works.**
  
-  To prevent injury or death, use a tractor equipped with a Roll-Over Protective System (ROPS). Do not paint over, remove or deface any safety signs or warning signs on your equipment. Observe all safety signs and practice the instruction on them.
  
-  Never exceed the limits of a piece of machinery. If its ability to do a job, or to do so safely, is in question – **DON'T TRY IT.**
  
-  Do not modify the equipment in any way. Unauthorized modification may impair the function and/or safety and could affect the life of the equipment.
  
-  In addition to the design and configuration of this implement, including Safety Signs and Safety Equipment, hazard control and accident prevention are dependent upon the awareness, concern, prudence, and proper training of personnel involved in the operation, transport, maintenance, and storage of the machine. Refer also to Safety Messages and Operation Instructions in each of the appropriate sections of the Tractor and Loader Manuals. Pay close attention to the Safety Signs affixed to the Tractor and the Loader.







# SAFETY INSTRUCTIONS (continued)



## SAFETY SIGNS





-  Keep safety signs clean and legible at all times.
-  Replace safety signs that are missing or have become illegible.
-  Replaced parts that displayed a safety sign should also display the current sign.
-  Safety signs are available from your Distributor or Dealer Parts Department or the factory.

### **How to Install Safety Signs:**

-  Be sure that the installation area is clean and dry.
-  Be sure temperature is above 50°F (10°C).
-  Decide on the exact position before you remove the backing paper.
-  Remove the smallest portion of the split backing paper.
-  Align the sign over the specified area and carefully press the small portion with the exposed sticky backing in place.
-  Slowly peel back the remaining paper and carefully smooth the remaining portion of the sign in place.
-  Small air pockets can be pierced with a pin and smoothed out using the piece of sign backing paper.



## TIRE SAFETY

-  Failure to follow proper procedures when mounting a tire on a wheel or rim can produce an explosion which may result in serious injury or death.
-  Do not attempt to mount a tire unless you have the proper equipment and experience to do the job.
-  Inflating or servicing tires can be dangerous. Whenever possible, trained personnel should be called to service and/or mount tires.
-  Always order and install tires and wheels with appropriate capacity to meet or exceed the anticipated weight to be placed on the equipment.

# **SAFETY INSTRUCTIONS (continued)**



## **SAFETY TRAINING**

 Safety is a primary concern in the design and manufacture of our products. Unfortunately, our efforts to provide safe equipment can be wiped out by a single careless act of an operator.

 In addition to the design and configuration of equipment, hazard control and accident prevention are dependent upon the awareness, concern, prudence and proper training of personnel involved in the operation, transport, maintenance and storage of equipment.

 It has been said, “The best safety device is an informed, careful operator.” We ask you to be that kind of an operator. It is the operator’s responsibility to read and understand ALL Safety and Operating instructions in the manual and to follow these. Accidents can be avoided.

 Working with unfamiliar equipment can lead to careless injuries. Read this manual, and the manual for your tractor, before assembly or operating, to acquaint yourself with the machines. It is the equipment owner’s responsibility, if this machine is used by any person other than yourself, is loaned or rented, to make certain that the operator, prior to operating:

1. Reads and understands the operator’s manuals.
2. Is instructed in safe and proper use.

 Know your controls and how to stop tractor, engine, and implement quickly in an emergency. Read this manual and the one provided with your tractor.

 Train all new personnel and review instructions frequently with existing workers. A person who has not read and understood all operating and safety instructions is not qualified to operate the machine. An untrained operator exposes himself and bystanders to possible serious injury or death.

 Do not allow children to operate this machine.



## **PREPARATION**

 Never operate the tractor, loader, and attachment until you have read and completely understand this manual, the Tractor Operator’s Manual, and each of the Safety Messages found on the safety signs on the tractor, loader, and attachment.

# SAFETY INSTRUCTIONS (continued)



## PREPARATION (continued)



Personal protection equipment including hard hat, safety glasses, safety shoes, and gloves are recommended during assembly, installation, operation, adjustment, maintaining, repairing, removal, or moving the implement. Do not allow long hair, loose fitting clothing or jewelry to be around moving parts.



### **PROLONGED EXPOSURE TO LOUD NOISE MAY CAUSE PERMANENT HEARING LOSS!**

Tractors with or without equipment attached can often be noisy enough to cause permanent, partial hearing loss. We recommend that you wear hearing protection on a full-time basis if the noise in the Operator's position exceeds 80db. Noise over 85db on a long-term basis can cause severe hearing loss. Noise over 90db adjacent to the Operator over a long-term basis may cause permanent, total hearing loss. **NOTE:** Hearing loss from loud noise (from tractors, chain saws, radios, and other such sources close to the ear) is cumulative over a lifetime without hope of natural recovery.



Operate the loader attachment only with a tractor equipped with an approved Roll-Over Protective System (ROPS). Always wear your seat belt on tractors equipped with a ROPS. Serious injury or even death could result from falling off the tractor – particularly during a turnover when the operator could be pinned under the ROPS or the tractor. Keep foldable ROPS systems in “locked up” position at all times.



Operate only in daylight or good artificial light.



Always check to be sure the loader attachment is properly latched on the loader or that lock pins are installed.



Ensure that all safety shielding and safety signs are properly installed and in good condition.



Never permit any person other than the operator to ride or board the tractor or implement at any time. **ALLOW NO RIDERS!**



The use of any loader attachment is NOT recommended on tractor with a tricycle wheel arrangement. Tricycle type tractors are unstable for front loader use.



A heavy load can cause instability in driving a tractor. Make sure the front or rear of the tractor is properly counter-balanced with weights. Always drive slowly – especially around turns. An unstable tractor could steer badly and possibly tip over, causing injury or death.



## OPERATIONAL SAFETY



















The use of this equipment is subject to certain hazards which cannot be protected against by mechanical means or product design. All operators of this equipment must read and understand this entire manual, paying particular attention to safety and operating instructions, prior to using. If there is something in this manual you do not understand, ask your supervisor, or your dealer, to explain it to you.



# SAFETY INSTRUCTIONS (continued)















## OPERATIONAL SAFETY (continued)

-  Most accidents occur because of neglect or carelessness. Keep all helpers and bystanders at a safe distance. REMEMBER FALLING BALES CAN ROLL OR TUMBLE.
-  Beware of low electrical wires when loader is raised. Serious injury or death can result if contact is made.
-  Always insert spears into the bale – NEVER under the bale. Failure to insert spears into bale can allow bale to roll back when loader is raised, causing serious injury or death.
-  Do not handle bales that exceed the bale weight limitations of the loader. Watch for bales that are frozen to the ground.
-  Carry the bale slowly and as low as possible to the ground.
-  Operate the loader controls smoothly, avoiding jerky operation.
-  When handling round bales on a slope, always approach the bale with the tractor facing uphill.
-  Never use the tractor/loader to stop a rolling bale.
-  Only use a tractor equipped with a ROPS cab or rollover protective structure. Keep foldable ROPS systems in “locked up” position at all times. Keep seat belt fastened.
-  When stacking bales, ALWAYS MAKE SURE BALES ARE PLACED SO THE STACK IS STABLE.
-  For operator safety, always keep bale in front of tractor hood. NEVER position bale back over operator. ALWAYS BE CAREFUL!
-  Always load rear of tractor first and unload last when using a front loader.
-  Beware of lift clearance when raising loader to maximum height.
-  Keep alert and watch the rear as well as the front when working with the loader.
-  When maneuvering close to buildings or passing through narrow areas, be sure to allow sufficient clearance for the tractor, loader, and bale. Drive slowly.
-  Operate loader from operator’s seat only. Remain at controls until operating cycle is complete.
-  Stop loader gradually when lowering or lifting loads.

# SAFETY INSTRUCTIONS (continued)



















## OPERATIONAL SAFETY (continued)

-  Allow for additional length of loader and bale on tractor while turning.
-  Never allow anyone to walk or work under a raised loader. Do not use loader for a work platform. Do not lift or carry anyone on loader or in bucket or on attachment.
-  Set both front and rear tractor wheels wide for increased stability.
-  Be sure that people, livestock, or pets are not standing near the machine while operating.
-  ALWAYS lower loader to the ground or block securely before performing any maintenance work.
-  Stay alert for holes, rocks and roots in the terrain and other hidden hazards. Keep away from drop-offs.
-  Use extreme care and maintain minimum ground speed when transporting on hillside, over rough ground and when operating close to ditches or fences. Be careful when turning sharp corners.
-  Reduce speed on slopes and sharp turns to minimize tipping or loss of control. Be careful when changing directions on slopes. Do not start or stop suddenly on slopes. Avoid operation on steep slopes.
-  When using a unit, a minimum 20% of tractor and equipment weight must be on tractor front wheels. Without this weight, tractor could tip over, causing personal injury or death. The weight may be attained with a front end loader, front wheel weights, ballast in tires of front tractor weights. When attaining a minimum 20% of tractor and equipment weight on the front wheels, you must not exceed the ROPS weight certification. Weigh the tractor and equipment. Do not guess or estimate!
-  Avoid excessive speed during operation.
-  ALWAYS lower spear points to the ground when parking tractor. Raised spear points could cause injury to people or livestock.
-  Always shut off tractor and shift to “Park” or set brakes when leaving tractor. Always lower bucket or attachment to ground. Remove key when leaving tractor unattended.
-  Before operating equipment: if you have any questions regarding the proper assembly or operation, contact your dealer or representative.

# SAFETY INSTRUCTIONS (continued)



## TRANSPORT SAFETY

-  Comply with state and local laws governing highway safety and movement of farm machinery on public roads.
-  The use of flashing amber lights is acceptable in most localities. However, some localities prohibit their use. Local laws should be checked for all highway lighting and marking requirements.
-  When driving the tractor and equipment on the road or highway under 20 mph (32 kph) at night or during the day, use flashing amber warning lights and a slow moving vehicle (SMV) identification emblem.
-  Always be sure the implement is in the proper raised position for transport.
-  Reduce speed when transporting mounted implements to avoid bouncing and momentary loss of steering control.
-  Plan your route to avoid heavy traffic.
-  Make sure large round bales transported on tractor rear 3 pt. hitch do not obstruct visibility of tractor's flashing lights or SMV sign.
-  When transporting large round bales, keep load as low as practical to maximize tractor stability.
-  Transporting large round bales on front loaders can limit visibility. Keep load low and go slow if visibility is obstructed. Always use extra care.
-  Do not exceed 20 mph (32 kph). Reduce speed on rough roads and surfaces.
-  Do not drink and drive!
-  Watch for traffic when operating near or crossing roadways.
-  Turn curves or go up or down hills only at a low speed and at a gradual steering angle. Make certain that at least 20% of the tractor's weight is on the front wheels to maintain safe steering. Slow down on rough or uneven surfaces, and loose gravel.
-  Use extreme care and maintain minimum ground speed when transporting on hillside, over rough ground and when operating close to ditches or fences. Be careful when turning sharp corners.
-  Never allow riders on either tractor or implement. Falling off can kill.
-  Be a safe and courteous driver. Always yield to oncoming traffic in all situations, including narrow bridges, intersections, etc.

# SAFETY INSTRUCTIONS (continued)



## MAINTENANCE SAFETY



Good maintenance is your responsibility. Poor maintenance is an invitation to trouble.



Follow good shop practices.

- Keep service area clean and dry.
- Be sure electrical outlets and tools are properly grounded.
- Use adequate light for the job at hand.



Make sure there is plenty of ventilation. Never operate the engine of the prime mover in a closed building. The exhaust fumes may cause asphyxiation.



Before working on this machine, drive to a level area, disengage the PTO, lower implement (or if working underneath, raise and block securely), shut off the engine, set the brakes, and remove the ignition keys.



Be certain all moving parts on attachments have come to a complete stop before attempting to perform maintenance.



Never work under equipment unless it is blocked securely. Never depend on hydraulic system to keep implement in raised position.



Keep all persons away from operator control area while performing adjustments, service, or maintenance.



Always use personal protection devices such as eye, hand and hearing protectors, when performing any service or maintenance.



Periodically tighten all bolts, nuts and screws and check that all cotter pins are properly installed to ensure unit is in a safe condition.



When completing a maintenance or service function, make sure all safety shields and devices are installed before placing unit in service.



Never use your hands to locate a hydraulic leak on attachments. Use a small piece of cardboard or wood. Hydraulic fluid escaping under pressure can penetrate the skin.









Openings in the skin and minor cuts are susceptible to infection from hydraulic fluid. If injured by escaping hydraulic fluid, see a doctor at once. Gangrene and death can result. Without immediate medical treatment, serious infection and reactions can occur.

# SAFETY INSTRUCTIONS (continued)









## MAINTENANCE SAFETY (continued)

-  After servicing, be sure all tools, parts and service equipment are removed.
-  Check to ensure all safety signs are installed and in good condition. (See safety sign section for location drawing.)
-  Do not allow grease or oil to build up on any deck or platform.
-  Never replace hex bolts with less than grade five bolts unless otherwise specified, i.e. shear bolts. Refer to bolt torque chart for head identification marking.
-  Where replacement parts are necessary for periodic maintenance and servicing, genuine factory replacement parts must be used to restore your equipment to original specifications. The manufacturer will not claim responsibility for use of unapproved parts and/or accessories and other damages as a result of their use.
-  If equipment has been altered in any way from original design, the manufacturer does not accept any liability for injury or warranty.
-  A fire extinguisher and first aid kit should be kept readily accessible while performing maintenance on this equipment.



## STORAGE SAFETY

-  Following operation or when unhooking, stop the tractor, set the brakes, disengage the PTO, shut off the engine and remove the ignition keys.
-  Never unhitch without using the tongue jack. The tongue is very heavy. Attempting to lift the tongue without using the tongue jack could cause strains. Allowing the tongue to fall suddenly and unexpectedly could result in crushing injury. Use the tongue jack for lifting the implement only. Overloading the jack can cause failure with possible serious bodily injury or even death.
-  Store the unit in an area away from human activity.
-  Do not park equipment where it will be exposed to livestock for long periods of time. Damage and livestock injury could result.
-  Do not permit children to play on or around the stored unit.
-  Make sure all parked machines are on a hard, level surface and engage all safety devices.
-  If blocking is used, make sure it is solid and secure before leaving area.

# SAFETY SIGNS

## **WARNING**

Always insert spears in bale – never under bale.

Failure to do this can allow bale roll back when loader is raised, causing serious injury or death.

101127

(Models GLB-3000, GLB-330, GLB-340)

## **BE CAREFUL!**

Use a clean, damp cloth to clean safety decals. Avoid spraying to close to decals when using a pressure washer; high-pressure water can enter through very small scratches or under edges of decals causing them to peel or come off.

## **REMEMBER:**

If Safety Signs have been damaged, removed, become illegible or parts replaced without Signs, new Safety Signs must be applied. New Safety Signs are available from your authorized distributor or factory.

## **WARNING**

- Read and follow owner's manual before installing, operating, or performing maintenance on this attachment. Observe safety recommendations in manual.
- Do not exceed weight limit of attachment or tractor.
- Do not lift or carry anyone on attachment.
- Attachment should be used with the proper weight package on front of tractor or with a loader installed. When handling loads on both ends of tractor, load rear first and unload last.
- Set wheels wide for increased stability.
- Never raise load to extreme heights on steep inclines.
- When handling large round bale, keep load as low as practical to maximize tractor stability.
- Make sure large round bale transported on tractor rear three point hitch attachment does not obstruct visibility of tractor's flashing lights or SMV sign.
- Do not stand or work under raised attachment.
- Stop engine, lower arms, relieve all hydraulic pressure, and lock brakes before leaving operator's seat.
- Failure to observe the above precautions can result in serious injury or death.

101277

# INSTRUCTIONS

## TRACTOR AND LOADER REQUIREMENTS AND PREPARATION

The Bale Spear Attachments are designed to fit Loaders equipped with a tool carrier that accepts Global or Euro Hook Style attachments.

The required size of the tractor and front loader will be determined by the size and weight of the bales to be handled.

Remember, high moisture hay (silage) bales are very heavy in relation to similar size dry hay bales.

Always use a power unit/loader large enough to safely handle your bales.

Always be sure your power unit is properly counterbalanced for a safe operation. **⚠ It is a good practice to use a loader with an equal or greater SAE operating load capacity.**

The maximum recommended weight of large round bales that can be handled by the various single/two spear models and weights of rectangular bales that can be handled by three spear units are as follows:

<u>Model</u>	<u>Spear Type</u>	<u>Bale Weight</u>
GLB-2200	Forged	Up to 2200 lbs.
GLB-3000	Forged (2)	Up to 3000 lbs.
GLB-330	Forged (3)	Up to 3000 lbs.
GLB-340	Forged (3)	Up to 4000 lbs.

### **⚠ WARNING! ⚠**

For multiple spear Models GLB-3000, GLB-330, GLB-340, always insert spears into the bale – NEVER under the bale. Failure to insert spears into bale can allow bale to roll back when loader is raised, causing serious injury or death.

Always use a tractor and front loader large enough to safely handle your bales.

Check your tractor and front loader to make sure they are in good working condition. Check all loader mounting bolts to make sure they are tight.

Check the tractor's hydraulic system. Be sure the hydraulic oil and filter have been serviced according to manufacturer's recommendations. Refer to your tractor or loader operator's manual or dealer for any adjustments necessary to put the hydraulic system in good working order.

Be sure tires and rims are in good condition. Inflate tires to the proper recommended air pressure.

### **⚠ CAUTION! ⚠**

Be sure your tractor and loader is in good condition. Read all the safety precautions and make sure all equipment operators are familiar with the safety rules of operation.

### **⚠ WARNING! ⚠**

■ Power unit must be equipped with ROPS or ROPS cab and seat belt. Keep seat belt securely fastened. Falling off power unit can result in death from being run over or crushed. Keep foldable ROPS systems in "locked up" position at all times.

■ Do not exceed the maximum recommended bale weight listed for each of the loader spear models. Damage to the equipment or serious personal injury could result.

■ A heavy load can cause instability in driving a tractor. Make sure the rear of the tractor is properly counter-balanced with weights. Always drive slowly – especially around turns. An unstable tractor could steer badly and possibly tip over, causing injury or death.

# INSTRUCTIONS (continued)

## ASSEMBLY

---

Refer to the “exploded views” on pages 19-23 of this manual.

Carefully follow instructions for final assembly.

Remove the bucket from your front end loader. Check your loader to make sure it is in good working order. Check all frame mounting bolts to make sure they are tight.

Place the main frame of the bale spear attachment on the universal euro tool carrier on the loader.

Raise loader slightly and retract tilt cylinders until latch closes.

**NOTE: Latch automatically closes on global carrier.**



**ALWAYS CHECK LATCH PINS BEFORE TILTING OR OPERATING ANY ATTACHMENT.**

Raise the loader and main frame slightly so that the bottom of the main frame is about two or three inches off the ground. Engage tractor parking brake and shut off the engine.

Place some solid blocking under the main frame of the bale spear attachment for safety.

**A.** On the Model GLB-2200, insert the long, forged main spear into the casting socket and align the cross hole in the spear with the hole in the socket. Install the  $\frac{1}{2}$ " x 3" bolt and tighten the nut.

Place the two short stabilizer spears into the sockets on the bottom of the main frame. Secure with the  $\frac{5}{16}$ " x  $1\frac{3}{4}$ " bolts provided.

**B.** On the Models GLB-3000, GLB-330, and GLB-340, install the long, forged main spears into the casting sockets in the main frame and align the cross hole in the spear with the hole in the socket. Install the  $\frac{1}{2}$ " x 3" bolt and tighten the nut on each spear.

## OPERATION

---

The operator is responsible for the safe operation of this equipment. The operator must be properly trained. Operators should be familiar with the attachment, tractor, and loader and all safety practices before starting operation.

Make sure all operators have read the Owner's/Operator's Manual and are familiar with the instructions and the safety rules of operation.

Be sure tractor is properly counter-balanced with weights before attempting to lift any load with the Bale Spear attachment.

If you are handling bales with both the front end loader and the 3 pt. hitch on the tractor, always load the 3 pt. attachment first and unload last.

The bale spear is to be used only for handling hay bales. Do not use for digging rocks, pulling out fence, or as a craning device with a chain over the spear.

### LARGE ROUND BALES:

Using the bucket tilt cylinders, adjust the angle of the spear(s) so they are parallel with the center of the hay bale.

With the tractor, push the spear(s) into the large hay bale. Make sure you have penetrated the hay bale far enough so the bale doesn't want to come off the end of the spear(s). If, when you initially pick the bale up, it tends to droop forward, this would indicate you have not penetrated the bale far enough.

Tilt the ends of the spear(s) upward (about 15-20 degrees) when transporting the hay bales. This will reduce any tendency for the bale to slide off the spear(s) while being transported.

When you have placed the hay bale in the desired location, it is recommended to tilt the spear ends slightly downward (5-7 degrees) so as you pull away from the bale it will slide off the spear(s) more easily. Different location and circumstances will determine the best withdraw angle to use.

**NOTE:** Always make sure bale spear fully penetrates the bale. Partial penetration locates all the weight of the bale on the outer end and can damage spear.



# INSTRUCTIONS (continued)

## **OPERATION (continued)**

**NOTE:** In cold weather, a bale frozen to the ground may exceed the lifting capacity of spear and loader. Damage to spear or loader may occur. Not covered under warranty.

**NOTE:** Soft center bales will tend to droop after being lifted by a single spear. Placing the spear in a lower position in the bale will allow for more lifting height and lessen the load on the stabilizer spears.



**NEVER LET ANYONE CLIMB ON STACKED ROUND HAY BALES!**

## **RECTANGULAR BALES:**

Using the bucket tilt cylinders, adjust the angle of the spear(s) so they are parallel with the center of the hay bale. Center the spears with the width of the bale.

With the power unit, push the spear(s) into the large hay bale. Make sure you have penetrated the hay bale far enough so the bale doesn't want to come off the end of the spear(s). If, when you initially pick the bale up, it tends to droop forward, this would indicate you have not penetrated the bale far enough.

Tilt the ends of the spear(s) upward (about 15-20 degrees) when transporting the hay bales. This will reduce any tendency for the bale to slide off the spear(s) while being transported.

When you have placed the hay bale in the desired location, it is recommended to tilt the spear ends slightly downward (5-7 degrees) so as you pull away from the bale it will slide off the spear(s) more easily. Different location and circumstances will determine the best withdraw angle to use.

**NOTE:** Optional bolt-on uprights are available to transport two rectangular bales at a time (see page 23). Order #831095 (one pair of uprights).

**NOTE:** Always make sure bale spear fully penetrates the bale. Partial penetration locates all the weight of the bale on the outer end and can damage spear.

**NOTE:** In cold weather, a bale frozen to the ground may exceed the lifting capacity of spear and loader. Damage to spear or loader may occur. Not covered under warranty.



**NEVER try to handle two rectangular bales at once without the 831095 optional bolt-on uprights installed. Failure to use the uprights can allow the top bale to roll back when loader is raised, causing serious injury or death.**

## **HANDLING ALL BALES:**

When stacking bales, ALWAYS MAKE SURE BALES ARE PLACED SO THE STACK IS STABLE.

Keep all bystanders at a safe distance. REMEMBER – FALLING BALES CAN ROLL OR TUMBLE.

When stacking hay bales or loading vehicles, make sure you are operating in an area AWAY FROM OVER-HEAD WIRES.



**Beware of low electrical wires when loader is raised. Serious injury or death can result if contact is made.**

**Do not leave the operator's seat if any part of the tractor or implement contacts electric lines.**



**Beware of lift clearance when raising loader to maximum height.**



■ **Never exceed the lift capacity of the tractor-loader used with the spear attachment.**

■ **A heavy load can cause instability in driving a tractor. Make sure the rear of the tractor is properly counter-balanced with weights or a bale. Always drive slowly – especially around turns. An unstable tractor could steer badly and possibly tip over, causing injury or death.**

# INSTRUCTIONS (continued)

## **HANDLE BALES SAFELY**

Improper use of loaders to handle bales can result in serious injury or death to the operator. This could be caused by the bale tumbling back down the loader into the operator's station.

For optimum stability and visibility:

- Become familiar with controls.
- Be sure anyone operating the loader is aware of safe operation and potential hazards. Read and observe safety recommendations in loader manual.
- Operate loader from operator's seat only. Remain at controls until operating cycle is complete.
- Carry the bale slowly and as low as possible to the ground.
- Operate the loader hydraulic controls smoothly, avoiding jerky operation.
- When handling round bales on a slope, always approach the bale with the power unit facing uphill.
- Never use the tractor/loader to stop a rolling bale.
- Stop loader gradually when lowering or lifting loads.
- Use particular care when working on inclines and hillsides.
- Avoid holes, ditches, and obstructions which may cause tractor/loader to tip.
- Allow for additional length of loader on tractor while turning.
- Never allow anyone to walk or work under a raised loader.
- Be sure that people, livestock, or pets are not standing near the machine while operating.
- Travel slowly over rough ground or when making turns.
- Drive slowly through gates and doors.
- Lower bucket or attachment to ground when loader is unattended.

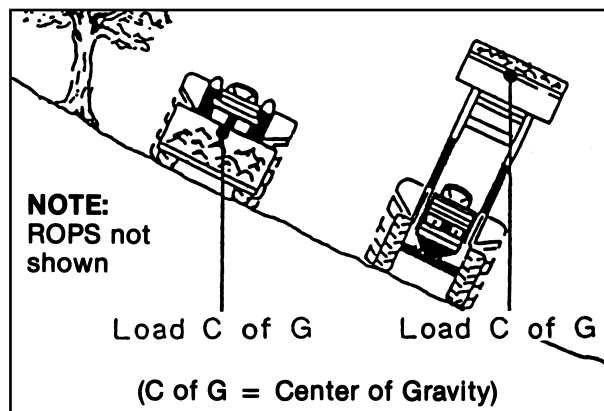

When working on side hills, **DO NOT RAISE LOADER TOO HIGH.** Keep an eye on terrain changes. Keep load low.

## **WARNING!**

For multiple spear models, always insert spears into the bale – **NEVER** under the bale. Failure to insert spears into bale can allow bale to roll back when loader is raised, causing serious injury or death.

## **TRANSPORTING**

### **CAUTION!**

When traveling on public roads, whether at night or during the day, use accessory light and devices for adequate warnings to operators of other vehicles. Comply with all federal, state and local laws.

Carry load low.

Check visibility. If visibility is impaired, reduce speed or consider other means of bale transport.

Allow for additional length of loader and spear attachment on tractor while turning.

Select a safe ground travel speed when transporting from one area to another. When traveling on roadways, transport in such a way that faster moving vehicles may pass you safely.

When traveling over rough or hilly terrain or when making turns, slow down and use extra care.

Read all the safety warnings in the front of this manual and in the manual of tractor.

# OWNER SERVICE

---

## MAINTENANCE

---



Always stop the tractor, set brake, shut off engine, remove key, and lower loader to ground before attempting to service. Never leave equipment unattended with engine running.



Do not work under a raised loader unless it is securely blocked or held in position. Do not depend on the hydraulic system to hold loader and attachment in place.

Check the pins at the ends of the loader arms. Make sure they are locked in place.

Periodically check all bolts to make sure they are tight.

Check the bolt on the forged spears to make sure it is tight.

Lubricate loader as per instructions in loader manual.

Replace safety signs and instruction decals if damaged or missing.

Replace any worn or damaged parts immediately. Do not use attachment with any damaged parts.

## STORAGE

---

- Never store equipment with fuel in the tank inside a building where fumes may reach an open flame or spark. Allow engine to cool before storing in an enclosure.
- Do not run engine indoors – exhaust gasses contain carbon monoxide, and odorless and deadly poison.
- At the end of the working season or when the attachment will not be used for a long period, it is good practice to clean off any dirt or grease that may have accumulated.
- Inspect the attachment for loose, damaged or worn parts and adjust or replace if needed.
- Sand areas where paint is chipped or worn and repaint to prevent rust.
- Storage location should be level and solid to make hitching and unhitching easy.
- Always store in a clean, dry location away from children and livestock.

**REPLACE SAFETY SIGNS  
IF DAMAGED OR MISSING.**

## GLB-2200 PARTS LIST

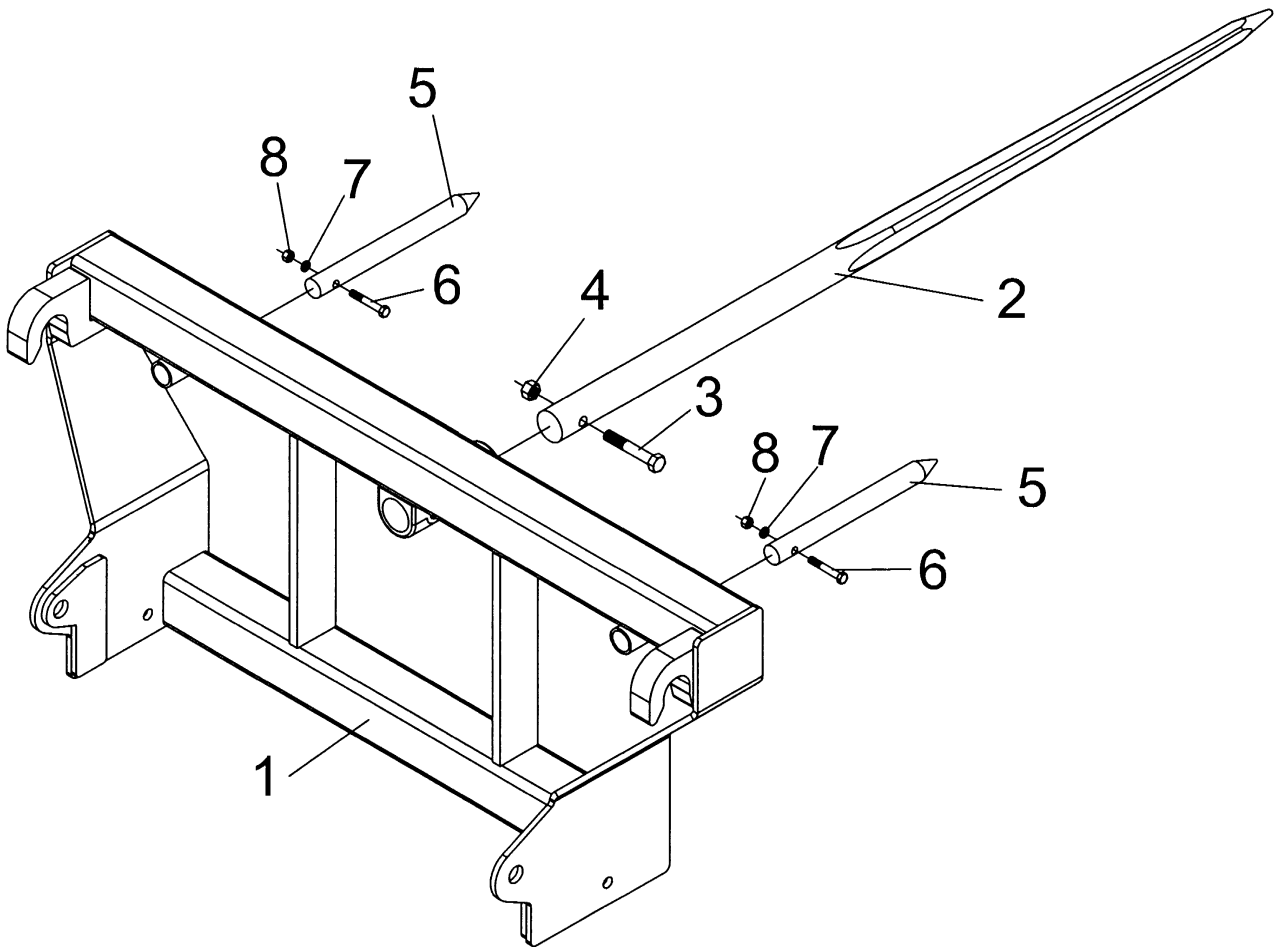

Ref. No.	Part No.	Description	No. Req'd.
1	832204	Main Frame Weldment (GLB-2200)	1
2	830928	Spear, Bolt-In (47.25")	1
3	2503012	Bolt 1/2"-13NC x 3" Hex Head Gr.2	1
4	2500054	Nut 1/2"-13NC Hex Stamplock	1
5	830213	Balance Spike	2
6	2503119	Bolt 5/16"-18NC x 2" Hex Head Gr. 2	2
7	2502011	Washer 5/16" Spring Lock	2
8	2500011	Nut 5/16"-18NC Full Hex	2

# GLB-3000 PARTS LIST

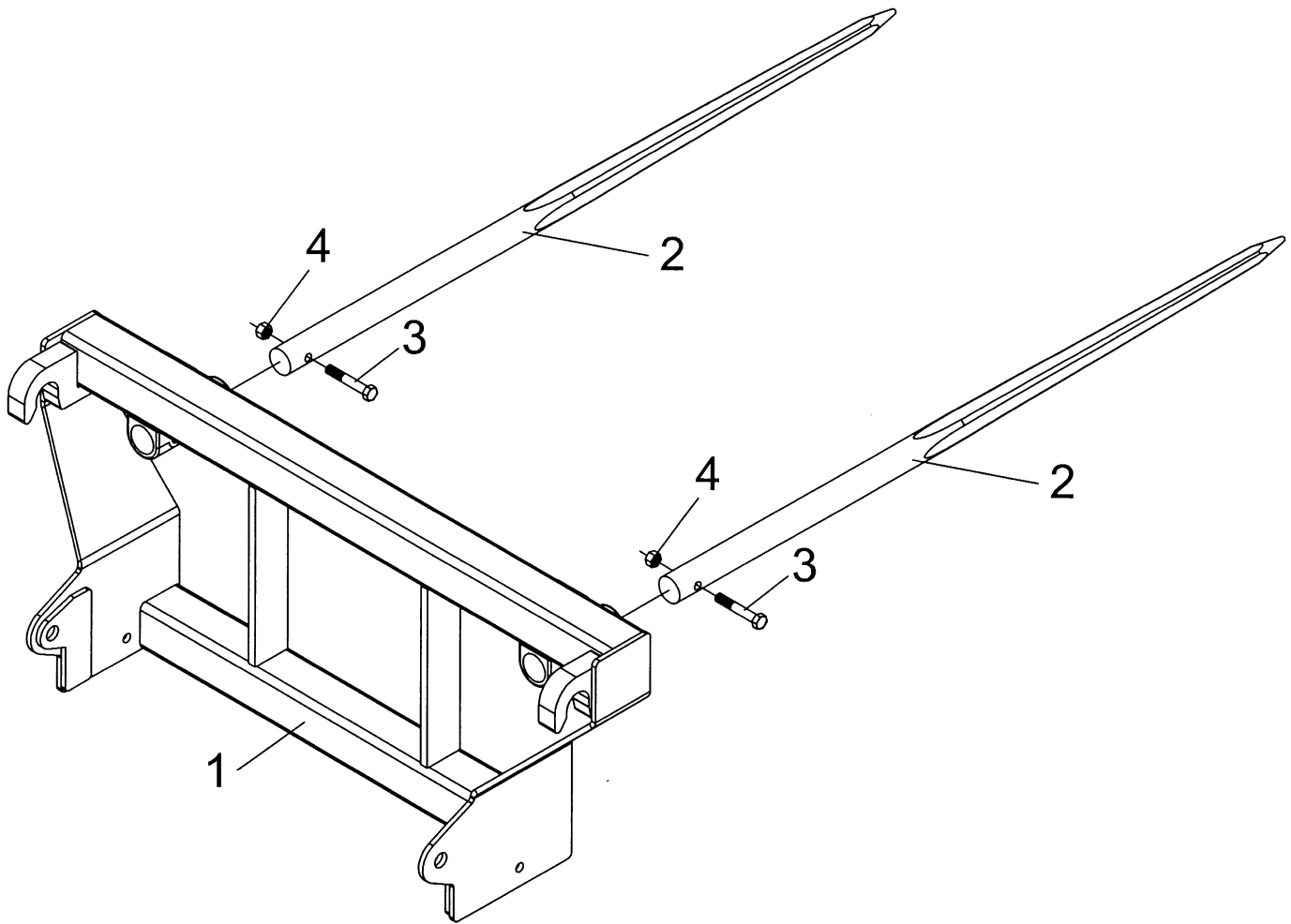

Ref. No.	Part No.	Description	No. Req'd.
1	832221	Main Frame Weldment (GLB-3000)	1
2	830928	Spear, Bolt-In (47.25")	2
3	2503012	Bolt 1/2"-13NC x 3" Hex Head Gr.2	2
4	2500054	Nut 1/2"-13NC Hex Stamplock	2

# GLB-330 PARTS LIST

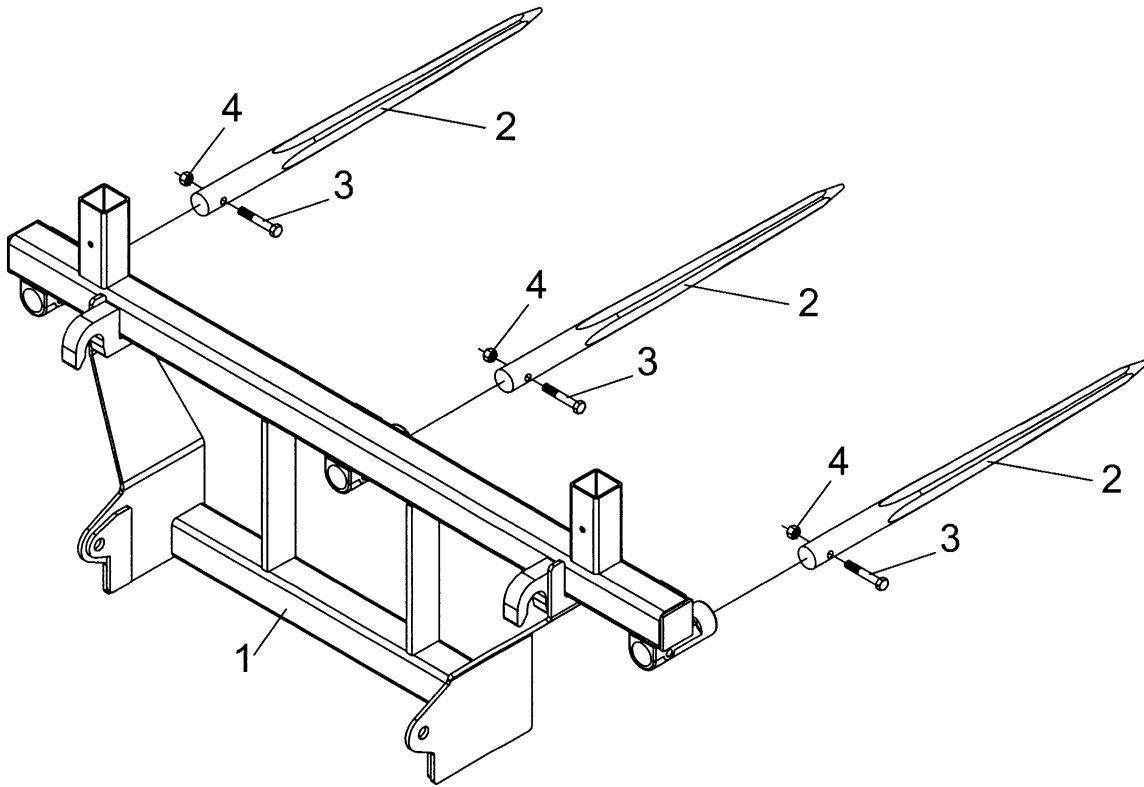

Ref. No.	Part No.	Description	No. Req'd.
1	832241	Main Frame Weldment (GLB-330/340)	1
2	830924	Spear, Bolt-In (31.50")	3
3	2503012	Bolt 1/2"-13NC x 3" Hex Head Gr.2	3
4	2500054	Nut 1/2"-13NC Hex Stamplock	3

# GLB-340 PARTS LIST

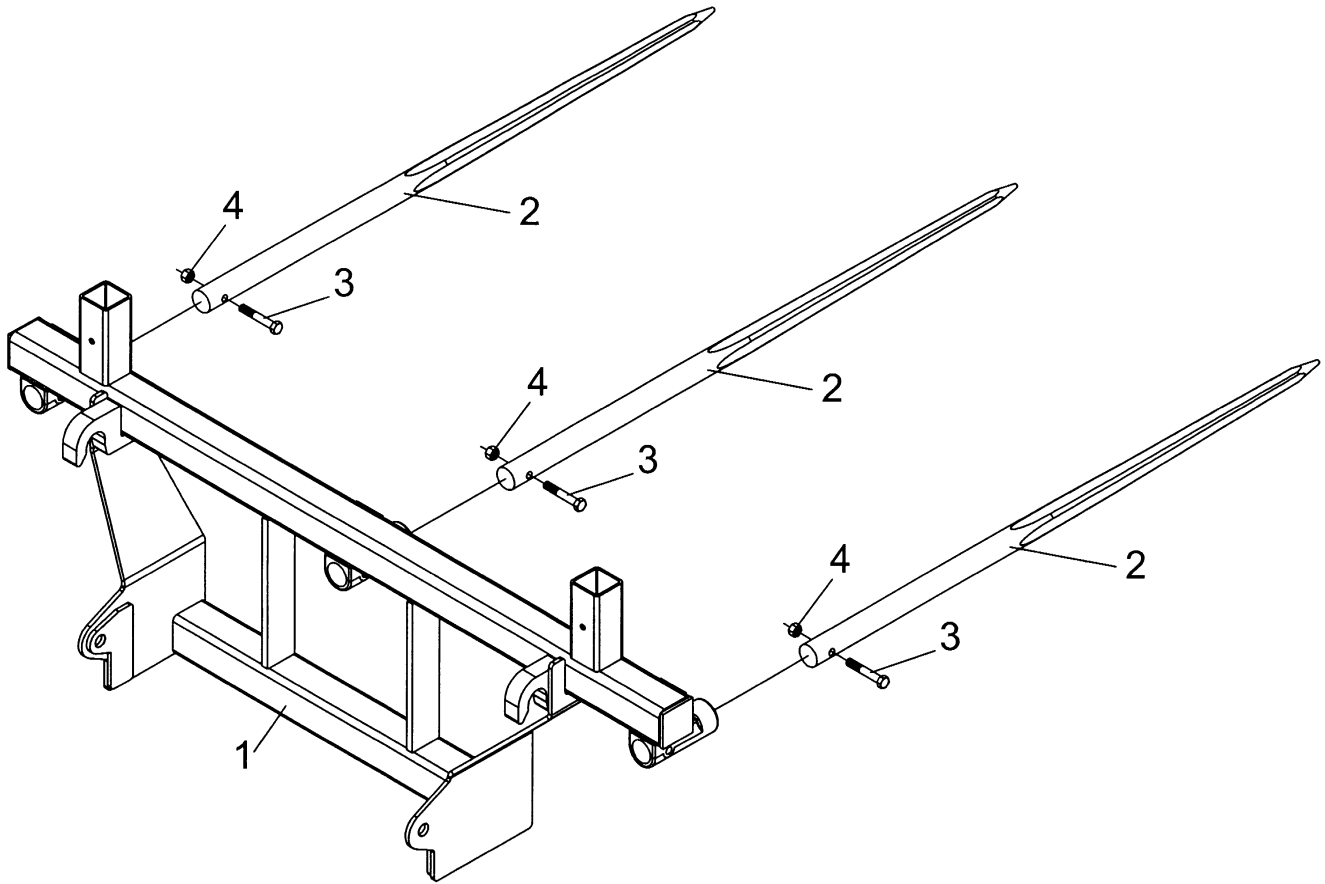

Ref. No.	Part No.	Description	No. Req'd.
1	832241	Main Frame Weldment (GLB-330/340)	1
2	830928	Spear, Bolt-In (47.25")	3
3	2503012	Bolt 1/2"-13NC x 3" Hex Head Gr.2	3
4	2500054	Nut 1/2"-13NC Hex Stamplock	3

# OPTIONAL UPRIGHT KIT PARTS LIST

## (#831095)

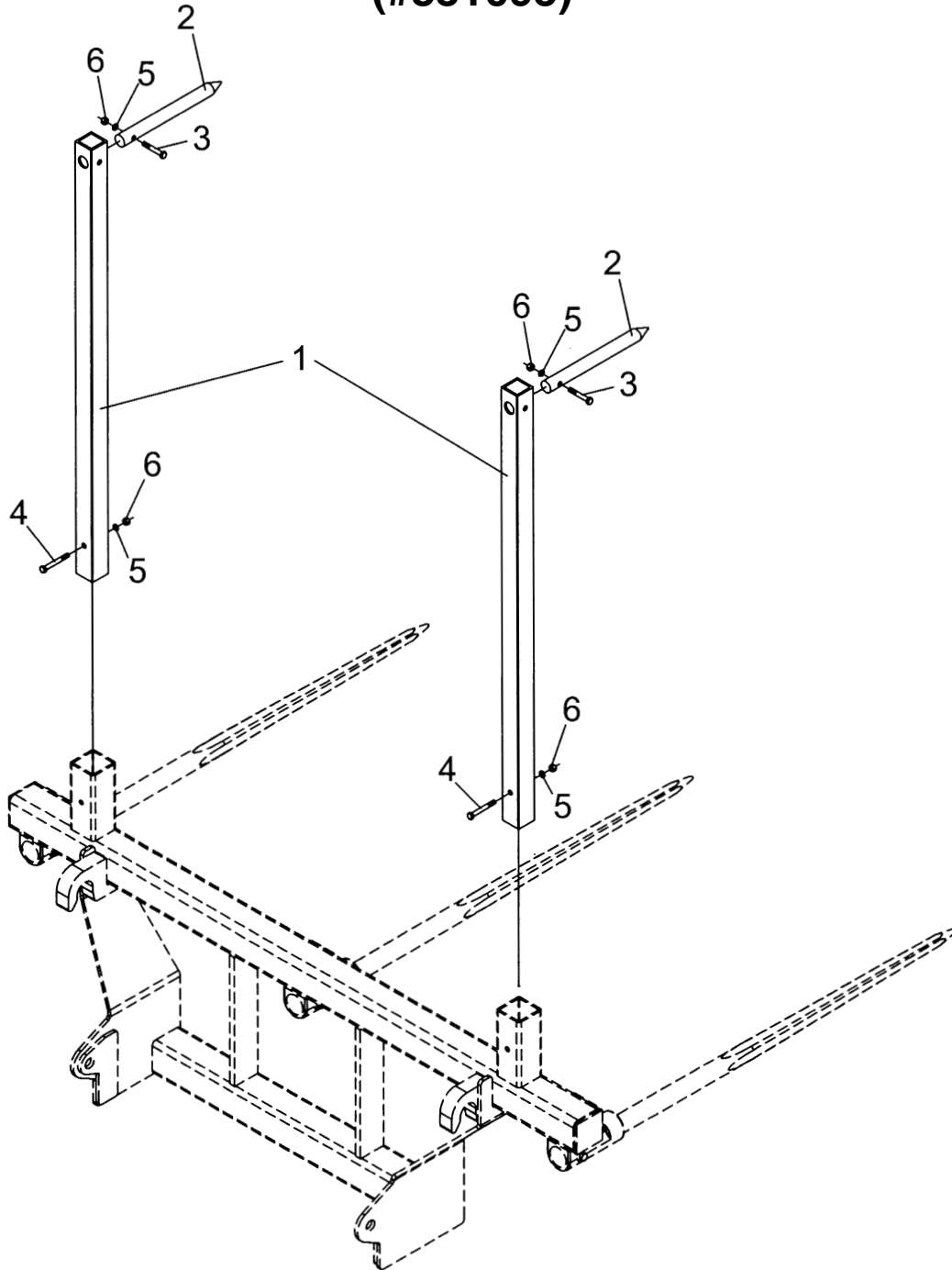

Ref. No.	Part No.	Description	No. Req'd.
1	832285	Tube, Vertical Backstop	2
2	830213	Balance Spike	2
3	2503039	Bolt 3/8"-16NC x 2 1/2" Hex Head Gr.2	2
4	2503209	Bolt 3/8"-16NC x 3" Hex Head Gr.2	2
5	2502008	Washer 3/8" Springlock	4
6	2500004	Nut 3/8"-16NC Full Hex	4



# **⚠ SAFETY PRECAUTIONS ⚠**

**MOST ACCIDENTS OCCUR BECAUSE OF NEGLIGENCE OR CARELESSNESS.  
AVOID NEEDLESS ACCIDENTS BY FOLLOWING ALL OF THE SAFETY PRECAUTIONS LISTED BELOW.**

- Machinery should be operated only by those who are responsible and are authorized to do so.
- Stop the engine, lower all equipment, lock the brakes, and remove the ignition key before dismounting from the tractor.
- Never stand between tractor and implement while tractor is being backed to hitch.
- Loose fitting clothing should not be worn, to avoid catching on various parts.
- Detach implement in area where children normally do not play.
- When performing adjustments or maintenance on an implement, first lower it to the ground or block it securely at a workable height.
- Only a qualified operator should be permitted on tractor when in operation; no riders allowed.
- Make certain everyone is in the clear before starting tractor or raising or lowering equipment.
- Operate the tractor and implement only while seated in the driver's seat.
- Reduce speed when transporting mounted implements to avoid bouncing and momentary loss of steering control.
- A heavy load can cause instability of the tractor. Use extreme care during road travel. Slow down on turns and watch out for bumps. Tractor may need front counterweights to counter-balance the weight of the implement.
- Reduce speed on hillsides or curves so there is no danger of tipping.
- Avoid driving too close to the edge of ditches or creeks.
- Do not transport implement on public roads without reflectors and slow moving vehicle emblem in daylight and with approved warning lights at night and other periods of poor visibility.
- Due to the width of some implements, use extra caution on highways, farm roads, and when approaching gates.
- Always be sure the implement is in the proper position for transport.
- Keep alert and watch the front as well as the rear when working with the implement.

## **OWNER'S/ OPERATOR'S MANUAL**

### **MODEL NO.'s**

**GLB-2200**

**GLB-3000**

**GLB-330**

**GLB-340**

**SINO LEEINGLES, PIDA AYUDA  
A AIGUIEN QUE SI LO LEA  
PARA QUE LE TRADUZCA LAS  
MEDIDAS DE SEGURIDAD.**

MAY 2008

## **GLOBAL/EURO-HOOK STYLE INTEGRATED DESIGN BALE SPEAR ATTACHMENTS**

**WHEN ORDERING REPAIR PARTS,  
ALWAYS GIVE THE FOLLOWING INFORMATION:**

1. PART NUMBER
2. PART DESCRIPTION
3. MODEL NUMBER
4. NAME OF ITEM

**MAKE EVERY DAY  
A HOLIDAY  
FROM ACCIDENTS!**

**WORKSAVER, INC.**

P.O. BOX 100 LITCHFIELD, IL 62056-0100 (217) 324-5973  
WEB: <http://www.worksaver.com> E-MAIL: [sales@worksaver.com](mailto:sales@worksaver.com)