

*User Guide*

# Basic 32 Loader Control

**B32 Model**

*Installation*

*Operation*

*Maintenance*

*Troubleshooting*



*Instant Access  
Parts and Service  
(800) 458-1960  
(814) 437-6861*

*[www.conairnet.com](http://www.conairnet.com)*



The Conair Group, Inc.  
One Conair Drive  
Pittsburgh, PA 15202  
Phone: (412) 312-6000  
Fax: (412)-312-6001

UGC007/0702

---

*Please record your equipment's model and serial number(s) and the date you received it in the spaces provided.*

It's a good idea to record the model, serial and software version numbers of your equipment and the date you received it in the User Guide. Our service department uses this information, along with the manual number, to provide help for the specific equipment you installed.

Please keep this User Guide and all manuals, engineering prints and parts lists together for documentation of your equipment.

<b>Date:</b>
<b>Manual Number: UGC007/0702</b>
<b>Model number:</b>
<b>Serial number(s):</b> ..... .....
<b>Software version number(s):</b> ..... .....

**DISCLAIMER:** The Conair Group shall not be liable for errors contained in this User Guide or for incidental, consequential damages in connection with the furnishing, performance or use of this information. Conair makes no warranty of any kind with regard to this information, including, but not limited to the implied warranties of merchantability and fitness for a particular purpose.

# TABLE OF CONTENTS

---

<b>INTRODUCTION</b> .....	<b>1-1</b>
Purpose of the User Guide.....	1-2
How the Guide is Organized .....	1-2
Your Responsibility as a User .....	1-2
ATTENTION: Read this so no one gets hurt .....	1-3
<b>DESCRIPTION</b> .....	<b>2-1</b>
What is the B32? .....	2-2
Typical Applications .....	2-2
How it Works .....	2-3
Specifications .....	2-4
<b>INSTALLATION</b> .....	<b>3-1</b>
Unpacking the Boxes .....	3-2
Preparing for Installation .....	3-3
Installing the B32 .....	3-4
Wiring Considerations .....	3-4
Mounting the Control .....	3-5
Connecting to the B32 .....	3-6
Wiring Loaders to the B32 .....	3-7
Wiring Pumps to the B32 .....	3-7
Wiring Purge Valves to the B32 .....	3-7
Connecting Main Power to the B32 .....	3-8
Initial Setup .....	3-9
Setting Loader Parameters .....	3-10
Enabling Loaders .....	3-11
Enabling Pumps .....	3-11
Selecting a Password .....	3-12
<b>OPERATION</b> .....	<b>4-1</b>
B32 Control Features .....	4-2
Viewing Loader Status .....	4-3
Enabling and Disabling Loaders .....	4-4
Enabling and Disabling Pumps .....	4-5
Configuring Loaders .....	4-6
Assigning Pumps and Loaders .....	4-7
Assigning a Backup Pump .....	4-8
Configuring the Alarm .....	4-9
Backing up the PLC Program .....	4-10
<b>MAINTENANCE</b> .....	<b>5-1</b>
Preventive maintenance checklist .....	5-2

---

# TABLE OF CONTENTS

<b>TROUBLESHOOTING</b> .....	<b>6-1</b>
Before Beginning .....	6-2
A Few Words of Caution .....	6-2
Identifying the Cause of a Problem .....	6-3
Clearing Interface Alarms .....	6-4
Clearing CPU and I/O alarms .....	6-5
Conveying System Alarms .....	6-6
Operator Interface Problems .....	6-8
Processor and power problems .....	6-8
CPU faults .....	6-9
I/O errors .....	6-9

## APPENDIX

Customer service information .....	A-1
Warranty information .....	A-2
Restoring the Program .....	B-1

## PARTS/DIAGRAMS

Wiring Diagrams
Recommended Spare Parts

---

# INTRODUCTION

- *Purpose of the User Guide .....1-2*
- *How the guide is organized .....1-2*
- *Your responsibilities as a user ...1-2*
- *ATTENTION: Read this so  
no one gets hurt .....1-3*

---

## PURPOSE OF THE USER GUIDE

This User Guide describes the Conair Basic 32 Loader Control and explains step-by-step how to install, operate, maintain and repair this equipment.

Before installing this product, please take a few moments to read the User Guide and review the diagrams and safety information in the instruction packet. You also should review manuals covering associated equipment in your system. This review won't take long, and it could save you valuable installation and operating time later.

---

## HOW THE GUIDE IS ORGANIZED

Symbols have been used to help organize the User Guide and call your attention to important information regarding safe installation and operation.



Symbols within triangles warn of conditions that could be hazardous to users or could damage equipment. Read and take precautions before proceeding.



Numbers within shaded squares indicate tasks or steps to be performed by the user.



A diamond indicates the equipment's response to an action performed by the user.



An open box marks items in a checklist.



A shaded circle marks items in a list.

---

## YOUR RESPONSIBILITY AS A USER

You must be familiar with all safety procedures concerning installation, operation and maintenance of this equipment. Responsible safety procedures include:

- Thorough review of this User Guide, paying particular attention to hazard warnings, appendices and related diagrams.
- Thorough review of the equipment itself, with careful attention to voltage sources, intended use and warning labels.
- Thorough review of instruction manuals for associated equipment.
- Step-by-step adherence to instructions outlined in this User Guide.

---

We design equipment with the user's safety in mind. You can avoid the potential hazards identified on this machine by following the procedures outlined below and elsewhere in the User Guide.

 **ATTENTION:**  
**READ THIS SO NO**  
**ONE GETS HURT**



**WARNING: Improper installation, operation or servicing may result in equipment damage or personal injury.**

This equipment should be installed, adjusted, and serviced by qualified technical personnel who are familiar with the construction, operation and potential hazards of this type of equipment.

All wiring, disconnects and fuses should be installed by qualified electrical technicians in accordance with electrical codes in your region. Always maintain a safe ground. Do not operate the equipment at power levels other than what is specified on the the equipment serial tag and data plate.



**WARNING: Electrical shock hazard**

This equipment is powered by electrical voltage as specified on the machine serial tag and data plate.

A properly sized conductive ground wire from the incoming power supply must be connected to the chassis ground terminal inside the Input/Output enclosure. Improper grounding can result in personal injury and erratic machine operation.

Always disconnect and lock out the incoming main power source before opening the electrical enclosure or performing non-standard operating procedures such as troubleshooting or routine maintenance. Only qualified personnel should perform troubleshooting procedures requiring access to the electrical enclosure while power is on.





---

## DESCRIPTION

- *What is the B32?* . . . . .2-2
- *Typical Applications* . . . . .2-2
- *How it Works* . . . . .2-3
- *Specifications* . . . . .2-4

---

## WHAT IS THE B32?

The control is mounted on the front of the I/O station. Inside is a processor with base, containing up to 8 input/output modules. The number of input and output modules will vary with the number of vacuum receivers and conveying options.

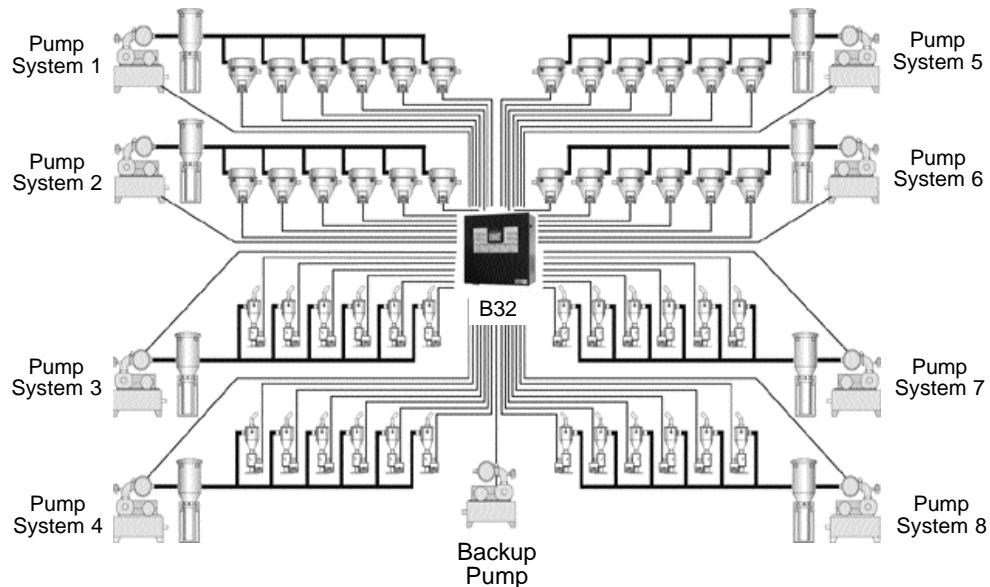

The controller and control automatically turn on when power is applied to the I/O station. After a bootup sequence the home screen displays. From the home screen the operator can scroll to all monitoring and control functions.

---

## TYPICAL APPLICATIONS

The Basic 32 has been designed for basic conveying applications.

Loader-pump assignments are completely flexible. Individual vacuum receivers can be assigned to any one of the eight loading systems. Each receiver can be configured for one of the following:

- Single-material loading.
- Ratio loading, with or without automatic material layering.
- Positive (air-operated) receiver discharge.
- Material line purging.
- Loader fill alarm to work with an optional fill sensor mounted in the receiver body or direct feed chamber.
- Hopper fill alarm to work with an optional demand sensor mounted in a drying hopper or other material vessel.
- No alarm.

---

## HOW IT WORKS

The B32 communicates with each pump, vacuum receiver and material valve wired to Input/Output modules within the control enclosure. The B32 controls conveying operation based on settings the operator enters on the HMI.

When receivers in a pump system demand material, the B32 turns on the vacuum pump and dust collector in the appropriate pump system. It then opens the correct vacuum and material valves to convey material to satisfy the demand.



The overview screen lets the operator monitor the status of all vacuum receivers at a glance. Icons indicate the real-time status of each receiver.

Other screens allow you to change system settings or to view pump systems, loader details, alarm histories.



# SPECIFICATIONS

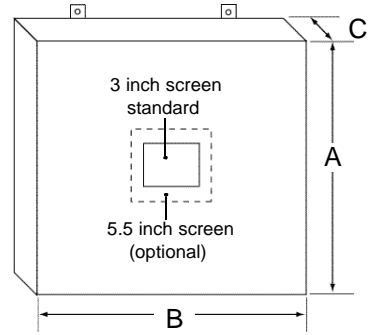

MODEL	B32
<b>Performance characteristics</b>	
Maximum number of vacuum receivers	32
Maximum number of vacuum pumps	8 (plus back-up)
Programmable logic controller	Allen Bradley Micrologix 1500
Touchscreen operator interface	Allen Bradley PV300 Micro
Communications with master control	DH485
Screen size, inches {mm}	2.87 X 1.67 {73 X 42}
User interface method	Keypad
Output voltage to receivers/valves	24 VDC
Sensor voltage to receivers	24 VDC
Output voltage to pumps	24 VDC
<b>Dimensions</b> inches {mm}	
Master control cabinet	
A - Height	31.4 {998}
B - Width	23.8 {606}
C - Depth	12.5 {318}
<b>Weight</b> lb {kg}	
Installed	70 {32}
Shipping	85 {39}
<b>Voltages</b> Total amps	
115V/1 phase/60Hz (master control)	10

## SPECIFICATION NOTES:

**B32 loader control cable:** 18 gauge shielded, 8-conductor may be used for standard vacuum receivers with up to one optional output and input, otherwise 10-conductor cable is required.

Specifications can change without notice. Check with your Conair representative for the most current information.

## APPLICATION NOTES:

Conair vacuum receivers come equipped with a quick-disconnect connector set that includes 10 feet of cable. Junction boxes must be provided to connect the system cable and each vacuum receiver's connector set.

## CALCULATING CABLE LENGTH:

Total the distances from the Input/output Station(s) location to each vacuum receiver on the system. Be sure to account for reasonable slack at each loading station for connections, cable routing, etc.

---

# INSTALLATION

- ***Unpacking the Boxes*** .....3-2
- ***Preparing for Installation*** .....3-3
- ***Installing the B32*** .....3-4
- ***Wiring Considerations*** .....3-4
- ***Mounting the Control*** .....3-5
- ***Connecting to the B32*** .....3-6
- ***Wiring Loaders to the B32*** .....3-7
- ***Wiring Pumps to the B32*** .....3-7
- ***Wiring Purge Valves to the B32*** ...3-7
- ***Connecting Main Power*** .....3-8
- ***Initial setup*** .....3-9
- ***Setting Loader Parameters*** .....3-10
- ***Enabling Loaders*** .....3-11
- ***Enabling Pumps*** .....3-11
- ***Selecting a Password*** .....3-12

---

# UNPACKING THE BOXES

The B32 central loading control comes in one box. The box should include:

- 1** Carefully remove the B32 components from their shipping containers, and set upright.
- 2** Remove all packing material, protective paper, tape and plastic.
- 3** Carefully inspect all components to make sure no damage occurred during shipping. Notify the shipper immediately if damage is found.
- 4** Take a moment to record serial numbers, the software version number and electrical power specifications in the blanks provided on the back of the the User Guide's title page. The information will be helpful if you ever need service or parts.
- 5** You are now ready to begin installation. Follow the preparation steps on the next page, paying particular attention to all wiring consideration and recommendations.

---

You should plan the location of the B32 control to ensure easy access and minimal wiring.

## PREPARING FOR INSTALLATION

### 1 Select a mounting location for the control.

The interface and Input/Output enclosure can be mounted on a wall or other stable vertical surface.

#### Select a location that:

**Is central to loaders that the B32 will control.** Keep the B32 Input/Output station as close as possible to the loading stations to minimize the amount of wire needed to connect the vacuum receivers to the control.

**Provides adequate clearance for safe operation and maintenance.** The control should be mounted at a height that allows the operator to easily see and touch the screen. Maintain at least 3 feet (1m) clearance in front of the control for safe access to the Input/Output enclosure.

**Provides a clean, dry, vibration-free environment.** Exposure to wide temperature variations, high ambient temperature, power line fluctuations, caustic fumes or excessive amounts of dust, dirt, vibration, shock and moisture could harm performance and reduce the life of this equipment.

**Provides a grounded source of 115 VAC power.** The three-prong power cord supplied with the B32 control requires a grounded 115 VAC outlet rated for at least 15 amp service.

### 2 Plan the power/communication cable routes.

**Review all wiring guidelines and diagrams** provided in the manuals and electrical diagrams supplied with the B32 control and your conveying equipment before beginning installation. See **WIRING CONSIDERATIONS**.

**Keep communication wires away from sources of static electricity.** Static electricity can damage the controls. Communication cables should *not* be run near the material lines and hoses, which produce large amounts of static electricity when material is conveyed. You should use shielded cable unless you run wires through metal conduit.

**Avoid running communication cables across power feed lines.** If you must run the cable across power feed lines, run the cable at right angles to the lines.

---

## INSTALLING THE B32

Installation of the B32 control consists of:

- Mounting the enclosure.
- Wiring loaders to the control.
- Wiring pumps to the control.
- Wiring material valves to the control.
- Connecting the control to a main power source.
- Initial setup of the system control.

---

## WIRING CONSIDERATIONS



**WARNING: Improper installation may result in equipment damage or personal injury.**

- Disconnect and lock out the main power supply to equipment in the conveying system before wiring power and communication cables between the B32 control, vacuum receivers, pumps, dust collectors and material valves.
- Install all wiring, disconnects and fuses in accordance with electrical codes in your region. All electrical installations should be done only by qualified electrical technicians.
- Always refer to the wiring diagrams supplied with your control before making electrical connections. The diagrams show the most accurate electrical component information.
- Protect communication cables from sources of static electricity and electrical noise.
- Use shielded cable or run wire through a contiguous metal conduit or wireway. Failure to use a metal shield can expose the controls to static electricity, which can damage electronic components.
- Do not run communication cables near material lines and hoses, which produce large amounts of static electricity when conveying material.
- Keep communication cables at least 5 ft. (1.5 m) from electric motors, transformers, rectifiers, arc welders, generators, induction furnaces and sources microwave radiation.
- Avoid running communication cable across power feed lines. If you must run cable across power lines, run the cable at right angles to the line. Keep the cable at least 6 inches (0.15 m) from AC power lines of less than 20 A; 1 foot (0.30 m) from lines of 20A to 100 kVA; and 2 feet (0.60 m) from lines of 100 kVA or more.





**WARNING: Improper installation may result in equipment damage or personal injury.**

- Always maintain a safe ground. Follow the safe grounding procedures in the wiring diagram package. Ground the shielded cable inside the Input/Output enclosure only.
- Do not operate the equipment at power levels other than those specified on the the equipment data plate.

---

The B32 Input/Output enclosure should be mounted on a wall, or other secure vertical surface, at a height providing easy access and a clear view of the touchscreen panel.

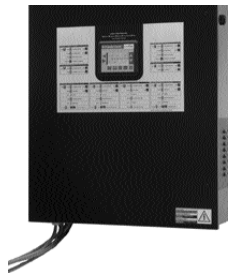

## MOUNTING THE CONTROL

**1 Bolt the control to the** mounting surface. Use the mounting brackets on the I/O enclosure.

**2 Ground the control enclosure.** Connect a ground wire to the control. Follow procedures outlined by your regional electrical codes and the wiring diagrams included with this manual.

# CONNECTING TO THE B32



**WARNING: Improper installation may result in equipment damage or personal injury.**

Always refer to the wiring diagrams that came with your controls before making electrical connections. The diagrams show the most accurate electrical component information.

Use shielded cable unless you run wires in metal conduit. Failure to use a metal shield will expose the controls to static electricity, which can damage electronic components.

When using shielded cable, make sure the shield is grounded inside the I/O stations only. It is also important to keep the communication wires away from conveying lines, which can produce large amounts of static electricity.

Each vacuum receiver, pump and material valve in the system must be wired to power or common/ground terminals and Input/Output modules inside the B32 control enclosure.

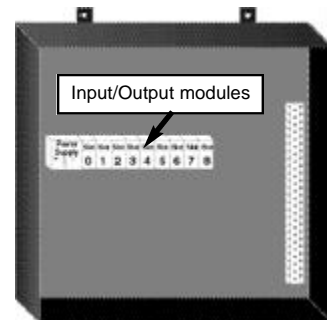

Each loader requires at least six wire connections to the Input/Output enclosure.

One additional wire is required for each option or for a three-wire sensor used for either demand or loader full inputs. Connect the loader cable wires to the I/O station according to the color codes:

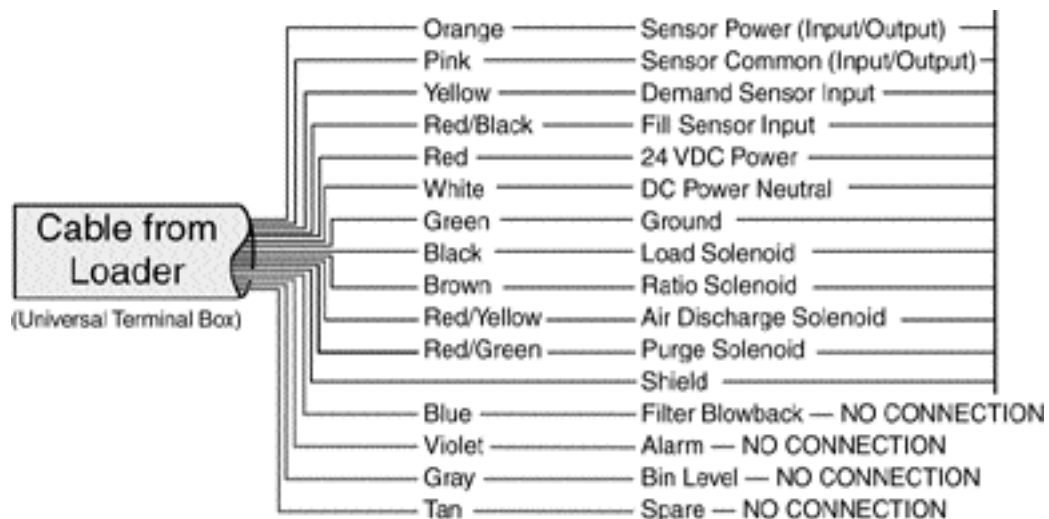

---

The loader wires connect to power terminals or terminals on the I/O modules inside the control enclosure. The number of loaders and options in the conveying system will determine the number of connections that are required.

Refer to the electrical prints included with this manual for all electrical connections to the loader control. All loader outputs are 24 VDC and all demand and fill sensor inputs are 24 VDC.

A general list of loader electrical connections is included in the appendix.

## WIRING LOADERS TO THE B32

**IMPORTANT:** Always refer to the wiring diagrams that came with your controls before making electrical connections. The diagrams show the most accurate electrical component information.

---

The B32 can run eight vacuum pumps and one backup pump. Refer to the electrical prints included with this manual for all electrical connections to the loader control. All pump outputs are 24 VDC and all overload inputs are 24 VDC.

## WIRING PUMPS TO THE B32

---

The B32 can operate up to 32 purge valves, which are used to remove material from the lines at the end of a loading cycle. Since purge valves are located at the material source instead of at the loader, separate wiring connections to the B32 are required.

## WIRING PURGE VALVES TO THE B32

(OPTIONAL)

---

# CONNECTING MAIN POWER TO THE B32

The B32 Input/Output enclosure is equipped with a three-prong plug and power cord. Each optional remote touchscreen panel also has its own plug and power cord.

- 1 Plug the power cord(s) into a grounded 115 VAC outlet rated for at least 15 Amp service.**
- 2 Make sure the control enclosure is grounded.**



## **WARNING: Electrical shock hazard**

Failure to provide proper grounding can cause control malfunctions and could result in personal injury from electrical shock.

The control must be connected to a grounded power source. A properly sized conductive ground wire must be connected to the chassis ground terminal inside the Input/Output enclosure.

# INITIAL SETUP

Before you can begin conveying, you must configure and identify the loaders and conveying features you want to use.

Procedures on the following pages will explain how to:

- Set loader parameters
- Enable pumps and loaders
- Select security password

To begin Initial Setup:

**1 Turn on power to the B32.**

The Power ON/OFF switch is on the left side of the control enclosure.

**2 Wait for the control to boot.**

Do not touch the control until it completes the bootup and initialization process. Process takes a few seconds. When the control has initialized, the Main Screen displays.

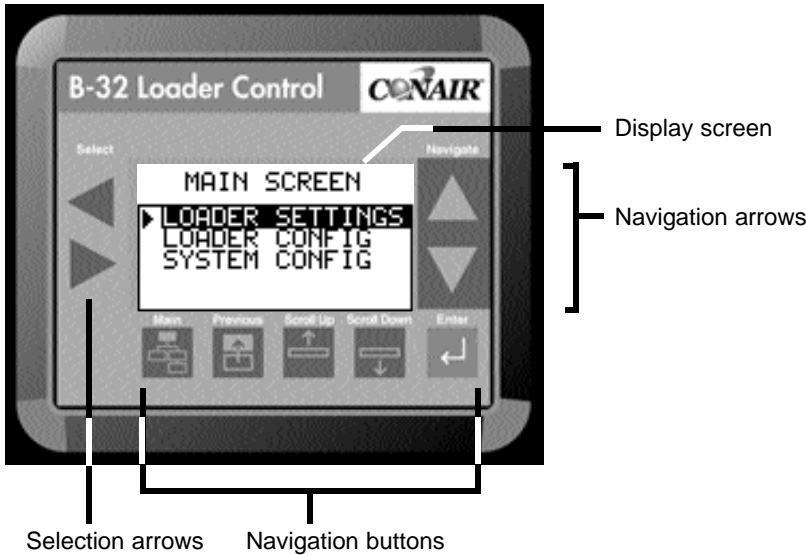

# SETTING LOADER PARAMETERS





## CAUTION: Incorrect configurations will cause the B32 control to stop.



Before enabling loaders and loading functions, make sure the loader, valve or option has been installed in the system. Each loader and feature must be wired to a correctly installed and enabled input or output module. The B32 will fault and the loading control will stop if the required I/O module has not been installed for the feature you enabled.

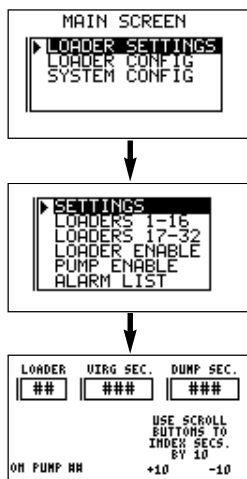

The loader must be correctly installed and wired before setting parameters.

To set loader parameters from the main screen:



- 1 Use the Up/Down arrows to scroll to Loader Settings.** 

- 2 Press the Enter arrow.**  
The Loader Settings screen displays. Use the up/down arrows to scroll to Settings.   

- 3 Press the Enter arrow.**  
The Settings screen displays. Use the left/right arrows to scroll to move the cursor to the Loader field. Use the up/down arrows to select loader.   
  

- 4 Use the Scroll Down/Up buttons to set the loader parameters: loader number, virgin time in seconds, dump time in seconds and pump number.** 

To enable the loaders from the main screen:

- 1 Use the Up/Down arrows to scroll to Loader Settings.**



- 2 Press the Enter arrow.**  
The Loader Settings screen displays. Use the up/down arrows to scroll to Loader Enable.



- 3 Press the Enter arrow.**  
The Loader Enable screen displays. Use the up/down arrows to increase and decrease the loader number. Use the scroll down/up buttons to enable/disable the loader.



## ENABLING LOADERS

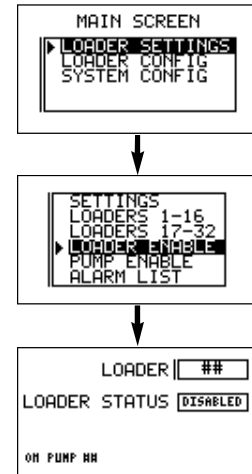

To enable the pumps from the main screen:

- 1 Use the Up/Down arrows to scroll to Loader Settings.**



- 2 Press the Enter arrow.**  
The Loader Settings screen displays. Use the up/down arrows to scroll to Pump Enable.



- 3 Press the Enter arrow.**  
The Pump Enable screen displays. Use the up/down arrows to increase and decrease the pump number. Use the scroll down/up buttons to enable/disable the pump.



## ENABLING PUMPS

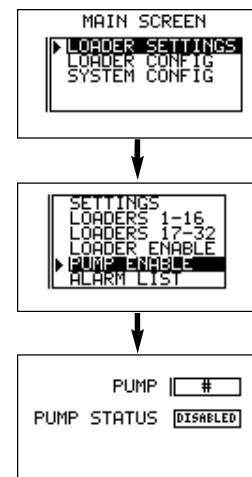

# SELECTING A PASSWORD

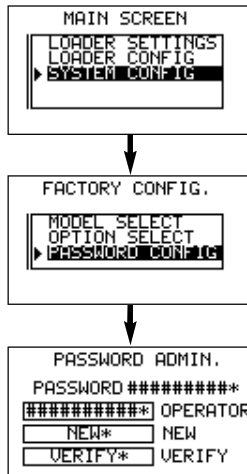

The B32 provides password security to prevent unauthorized changes to loader or system settings.

**1 Use the Up/Down arrows to scroll to System Config.** Entering the System Configuration screen requires a Supervisor 2 password. 

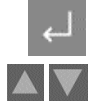
**2 Enter the password.** To enter the password use the up/down arrows to scroll through the alphanumeric list. When the correct letter/number is highlighted use the right Select arrow to move to the next digit. Continue until the whole password is selected. The initial passwords are set at the factory: 

- Supervisor 1: 7373
- Supervisor 2: 54647

Change these passwords and record the new passwords in a safe place.

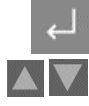
**3 Press the Enter arrow.** The Factory Configuration screen displays. Use the scroll up/down buttons to scroll to the New field. Use the up/down arrows to scroll through the alphanumeric list. When the correct letter/number is highlighted use the right Select arrow to move to the next digit. Continue until the whole password is selected. 

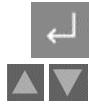
**4 Press the Enter arrow.** The Password Administration screen displays. Use the up/down arrows to scroll through the alphanumeric list. When the correct letter/number is highlighted use the right Select arrow to move to the next digit. Continue until the whole password is selected. 

**5 Press the Enter arrow to accept the password.** 

**6 Press the Main button to return to the main screen.** 



---

# OPERATION

- ***B32 Control Features . . . . .4-2***
- ***Viewing Loader Status . . . . .4-3***
- ***Enabling and Disabling  
Loaders . . . . .4-4***
- ***Enabling and Disabling  
Pumps . . . . .4-5***
- ***Configuring Loaders . . . . .4-6***
- ***Assigning Pumps and Loaders . . .4-7***
- ***Assigning a Backup Pump . . . . .4-8***
- ***Configuring the Alarm . . . . .4-9***
- ***Backing up PLC Program . . . . .4-10***

# B32 CONTROL FEATURES

The B32 operator interface allows you to view the status of the vacuum receivers and pumps in your conveying system at a glance. It also provides access to screens to enter settings for each loading station, view alarms and change system parameters.

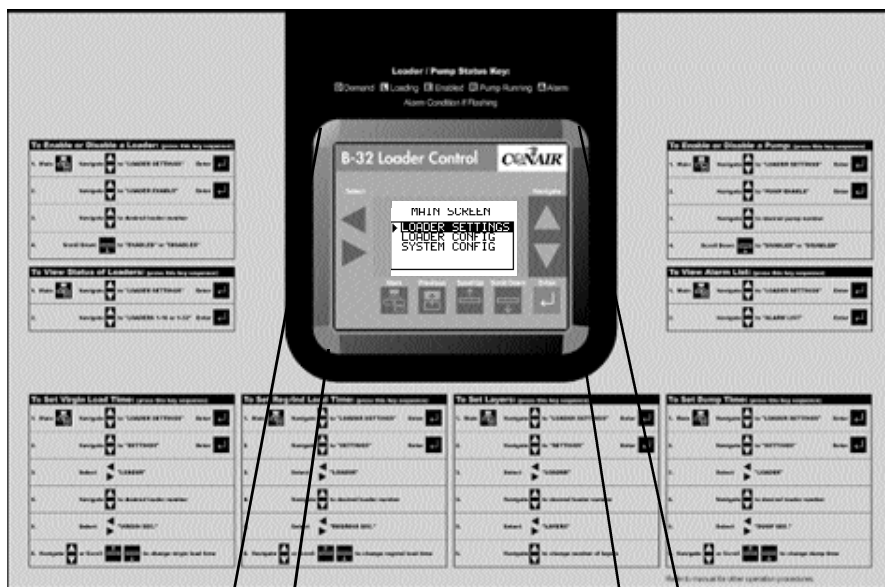

## Quick-reference guides

Scroll to:

- Enable/disable loaders and pumps
- Set load times, layers and dump times
- View loader status and alarm list

## Loader Settings

Scroll to:

- Set loader parameters
- View loader status
- Enable loaders
- Enable pumps
- View alarm list

## System Configuration

Prevent accidental or unauthorized changes to system settings with security password.

## Loader Configuration

Allows you to:

- Configure a loader
- Assign a loader to a pump
- Assign a backup pump
- Configure loader alarms
- Backup PLC program and settings
- Restore a program
- Display and clear PLC errors

To view loader status from the main screen:

- 1 Use the Up/Down arrows to scroll to Loader Settings.



- 2 Press the Enter arrow.

The Loader Settings screen displays. Use the up/down arrows to scroll to Loader 1-16.



- 3 Press the Enter arrow.

The Loader Status screen displays. The current status of each loader and pump displays. The status choices include:

- E** - enabled
- D** - in demand
- L** - loading
- - disabled
- R** - running

The status of up to 16 loaders and four pumps display status on each screen.

- 4 Use the Scroll Down/Up buttons to view the remaining loaders and pumps.



## VIEWING LOADER STATUS

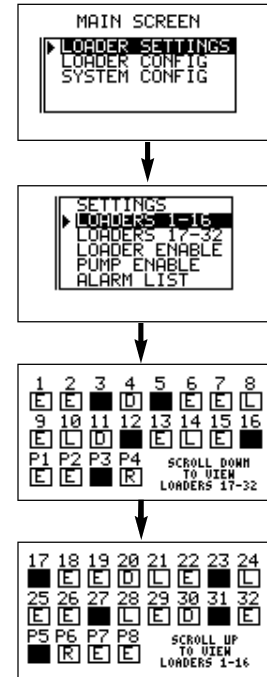

# ENABLING AND DISABLING LOADERS



**WARNING:** Develop and follow procedures for safe operation of the system to avoid possible injury or equipment damage.

The B32 allows operators and maintenance personnel to disable and enable conveying system components from remote locations. Unexpected energization of these components could result in equipment damage or injury.

### Safe operating procedures should include:

- Disconnect any loader, pump or material valve from main power and/or compressed air sources before servicing. Ensure that all energy sources for the device are locked out and tagged.
- Before removing lockout devices or enabling pumps, loaders or material valves, make sure that all personnel are clear of the machine, tools have been removed and any safety guards have been reinstalled.

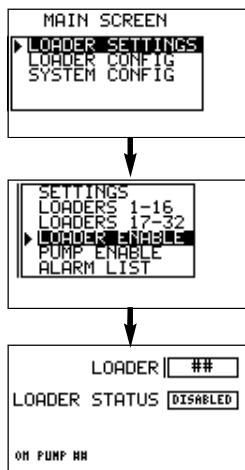

To enable the loaders from the main screen:

**1 Use the Up/Down arrows to scroll to** Loader Settings.



**2 Press the Enter arrow.**

The Loader Settings screen displays. Use the up/down arrows to scroll to Loader Enable.



**3 Press the Enter arrow.**

The Loader Enable screen displays. Use the up/down arrows to increase and decrease the loader number. Use the Scroll Down/Up buttons to enable/disable the loader.



**4 Press the Enter arrow to save the change.**



**5 Press the Previous button to return to** the last screen you were viewing, or the Main button to return to the Main screen.



# ENABLING AND DISABLING PUMPS



**WARNING:** Develop and follow procedures for safe operation of the system to avoid possible injury or equipment damage.

The B32 allows operators and maintenance personnel to disable and enable conveying system components from remote locations. Unexpected energization of these components could result in equipment damage or injury.

**Safe operating procedures should include:**

- Disconnect any loader, pump or material valve from main power and/or compressed air sources before servicing. Ensure that all energy sources for the device are locked out and tagged.
- Before removing lockout devices or enabling pumps, loaders or material valves, make sure that all personnel are clear of the machine, tools have been removed and any safety guards have been reinstalled.

To enable the pumps from the main screen:

**1 Use the Up/Down arrows to scroll to Loader Settings.**



**2 Press the Enter arrow.**

The Loader Settings screen displays. Use the up/down arrows to scroll to Pump Enable.

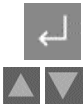

**3 Press the Enter arrow.**

The Pump Enable screen displays. Use the up/down arrows to increase and decrease the pump number. Use the scroll down/up buttons to enable/disable the pump.



NOTE: When a pump is disabled the loader completes its load cycle before the pump is de-energized.

**4 Press the Enter arrow to save the change.**



**5 Press the Previous button to return to the last screen you were viewing, or the Main button to return to the Main screen.**

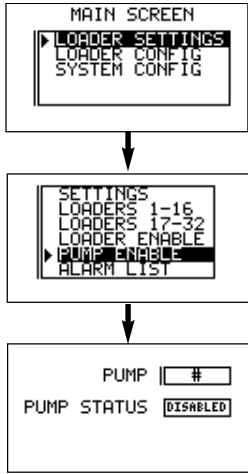
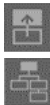



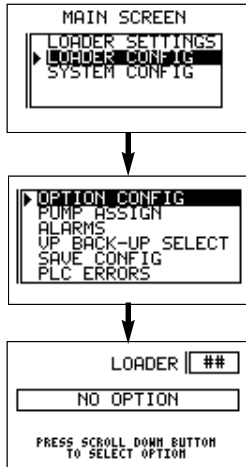





# CONFIGURING LOADERS



You may need to change loader settings whenever you change materials or to obtain the best conveying performance.

To configure loaders from the main screen:

- 1 Use the Up/Down arrows to scroll to Loader Config.** 
- 2 Press the Enter arrow.** The Loader Configuration screen displays. Use the up/down arrows to scroll to Option Config.   

- 3 Press the Enter arrow.** The Option Configuration screen displays. Use the up/down arrows to increase and decrease the loader number. Use the scroll down/up buttons to select option:
  - Discharge
  - Ratio
  - Ratio with Calc
  - Purge
  - Material valve
  - No option  
  

- 4 Press the Enter arrow to save the change.** 
- 5 Press the Previous button to return to the last screen you were viewing, or the Main button to return to the Main screen.**   

You may need to change loader and pump assignments to match the conveying system vacuum and XXXX

To assign loaders and pumps from the main screen:

- 1 Use the Up/Down arrows to scroll to Loader Config.**
- 2 Press the Enter arrow.**  
The Loader Configuration screen displays. Use the up/down arrows to scroll to Pump Assign.
- 3 Press the Enter arrow.**  
The Pump Assignment screen displays. Use the up/down arrows to choose the loader number. Use the scroll down/up buttons to choose the pump number.
- 4 Press the Enter arrow to save the change.**
- 5 Press the Previous button to return to the last screen you were viewing, or the Main button to return to the Main screen.**



## ASSIGNING LOADERS AND PUMPS

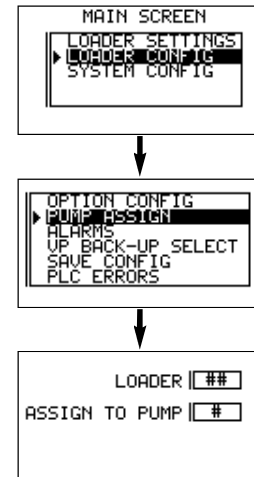



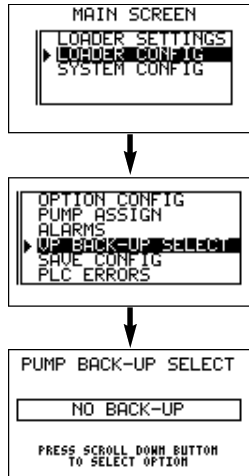



# ASSIGNING A BACKUP PUMP



A backup pump can be assigned to replace any of the eight pump systems during operation.









To assign a backup pump:

- 1 Use the Up/Down arrows to scroll to Loader Config.** 
- 2 Press the Enter arrow.**   
The Loader Configuration screen displays. Use the up/down arrows to scroll to VP Back-Up Select. 
- 3 Press the Enter arrow.**   
The Pump Back-up Select screen displays. Use the scroll down/up buttons to select a backup pump (pumps 1 through 8) or no backup pump. 
- 4 Press the Enter arrow to save the change.** 
- 5 Press the Previous button to return to the last screen you were viewing, or the Main button to return to the Main screen.** 



The loader can be configured for demand alarm, fill alarm or no alarm.

To configure the alarm from the main screen:

- 1 Use the Up/Down arrows to scroll to Loader Config.** 
- 2 Press the Enter arrow.**  
The Loader Configuration screen displays. Use the up/down arrows to scroll to Alarms.   

- 3 Press the Enter arrow.**  
The Alarm Configuration screen displays. Use the scroll down/up buttons to choose the alarm configuration you want:
  - No alarm
  - Demand alarm
  - Fill alarm  
  

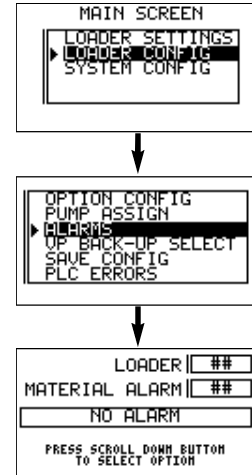
- 4 Press the Enter arrow to save the change.** 
- 5 Press the Previous button to return to the last screen you were viewing, or the Main button to return to the Main screen.**   

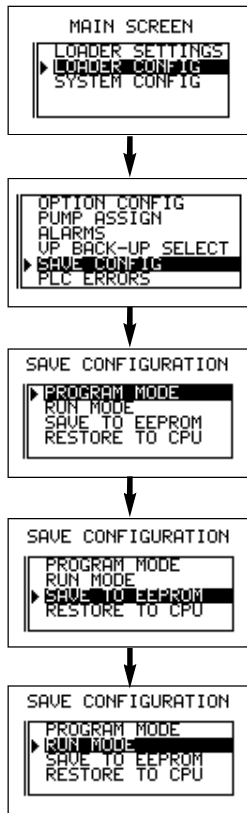

## CONFIGURING THE ALARM





# BACKING UP PLC PROGRAM (OPTIONAL)





To back up the PLC program and save the configuration:

- 1 Use the Up/Down arrows to scroll to Loader Config.** 
- 2 Press the Enter arrow.** 

The Loader Configuration screen displays. Use the up/down arrows to scroll to Save Config.
- 3 Press the Enter arrow.** 

The Save Configuration screen displays. Use the up/down arrows to scroll to Program Mode
- 4 Press the Enter arrow.** 

The Program Mode screen displays. Use the up/down arrows to select Save to EEPROM. The screen displays message when transfer is complete.
- 5 Use the Up/Down arrows to select Run Mode.** 

NOTE: All pumps must be disabled to save the configuration. This insures that all putputs are turned off.
- 6 Press the Enter arrow to save the change.** 
- 7 Press the Previous button to return to the last screen you were viewing, or the Main button to return to the Main screen.** 

---

# MAINTENANCE

- *Maintenance checklist . . . . .5-2*

---

# PREVENTIVE MAINTENANCE CHECKLIST

You should develop a preventive maintenance schedule for all components in the conveying system to ensure optimum operation and performance.

The B32 may require the following maintenance checks:

- **Whenever you change materials**

- Verify the loader settings** for pump systems or loaders effected by the material change. Pay particular attention to load times and dump times. See **CHANGING LOADER SETTINGS** in the Operation section.

- **Quarterly**

- Check power and cable connections and wires.**  
Over time, the power and cable connections between the B32 and conveying system components may become loose or wires may become worn. Tighten any loose connections and replace any wire or cable that has become worn or damaged.

---

# TROUBLESHOOTING

- *Before Beginning* . . . . .6-2
- *A Few Words of Caution* . . . . .6-2
- *Identifying the Cause of a Problem* . . . . .6-3
- *Clearing Interface Alarms* . . . . .6-4
- *Clearing CPU and I/O alarms* . . .6-5
- *Conveying System alarms* . . . . .6-6
- *Operator Interface Problems* . . . . .6-8
- *Processor and Power Problems.* . . . . .6-8
- *CPU faults* . . . . .6-9
- *I/O errors* . . . . .6-9

---

## BEFORE BEGINNING

### Before you begin troubleshooting:

- Find the manuals and wiring diagrams that were shipped with your equipment.

These materials contain details you will need to diagnose and repair problems in specific components, including custom wiring, features or I/O options not covered in this User Guide.

---

## A FEW WORDS OF CAUTION



### **WARNING: Improper installation, operation or servicing may result in equipment damage or personal injury.**

The B32 should be installed, adjusted, and serviced only by qualified technical personnel who are trained in the operation and troubleshooting of this type of equipment.



### **DANGER: Electrical shock hazard**

Diagnosing the cause of electrical system and CPU problems in this equipment may require the use of precision electronic measuring equipment, as well as access to the electrical enclosure while power is on. Only qualified electrical technicians, trained in the use of this equipment and in avoiding exposure to voltage hazards, should perform procedures that require access to the enclosure while power is on.



### **WARNING: Develop and follow procedures for safe operation and maintenance of the system.**

The B32 allows operators and maintenance personnel to disable and enable conveying system components from remote locations.

Unexpected energization of these components could result in equipment damage or injury.

### **Safe maintenance procedures should include:**

- Disconnect any loader, pump or material valve from main power and/or compressed air sources before servicing. Ensure that all energy sources for the device are locked out and tagged.
- Before removing lockout devices and enabling system components, verify that all personnel are clear of the machine, tools have been removed, and any safety guards have been reinstalled.

---

The TROUBLESHOOTING section explains how to clear an alarm, and provides diagnostic tables to help you determine the cause of the alarm.

Diagnostic tables have been divided into:

**❑ Conveying System Alarms.**

These tables focus on the “No Material” and “Pump Overload” alarms that the B32 displays on the Alarm Summary screen. The B32 continues to control the system and the alarming loading station will load.

**❑ Power and Processor Problems.**

These tables focus on power supply and processor problems indicated by Micrologix 1500 LEDs located inside the I/O enclosure. These problems cause the B32 control to stop.

**❑ CPU Faults.**

These tables focus on Hex error codes that apply to the Micrologix 1500 and are displayed as faults on the Rack & Slot screen. These problems cause the B32 control to stop.

## IDENTIFYING THE CAUSE OF A PROBLEM

**IMPORTANT:** Refer to the manuals supplied by the manufacturers of loaders, pumps and material valves in your system for additional diagnostic and repair information.

# CLEARING INTERFACE ALARMS

When a conveying problem occurs, the screen displays the alarm message and the audible alarm sounds.

To silence the alarm and fix the problem:

## 1 Press the Enter button.

This acknowledges the alarm. The alarm text is removed from the screen. The screen returns to the Main screen. NOTE: pressing the Enter button only acknowledges the alarm; it does not fix the problem.



## 2 View Alarm list.

From the Main screen use the Up/Down arrows to scroll to Loader Settings. Press Enter. The Loader Settings screen displays.



## 3 Use the Up/Down arrows to scroll to Alarm List.

Press Enter to display alarms. The alarm list displays up to 25 alarms, starting with the most current. All acknowledged alarms have a check mark next to the text. All alarms show the hour, minute and second the alarm occurred. Alarms are automatically removed from the list when the condition is corrected.



## 4 Fix the problem.

Refer to the diagnostic tables in this section and any manuals supplied with this device to determine the cause of the problem and to repair the problem.

## 5 Press Main button to return to main screen or the Previous button to return to the last screen viewed.

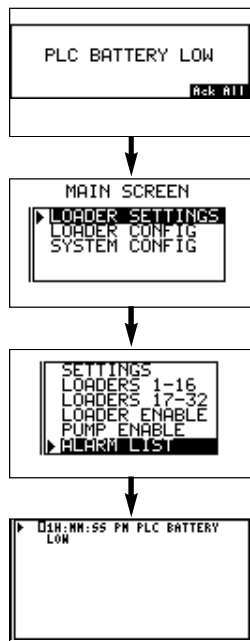
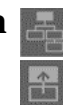











CPU and Input/Output errors will stop the B32 control.

These errors may be caused by problems with the power supply, processor or Input/Output modules. The error is indicated by error codes on the PLC Error screen or by LEDs on the B32 MicroLogix1500 CPU and power supply modules.

To clear and fix a CPU or I/O error from the Main screen:

- 1 Use the Up/Down arrows to scroll to Loader Config.** 
- 2 Press the Enter arrow.**   
The Loader Configuration screen displays. Use the up/down arrows to scroll to PLC Errors. 
- 3 Press the Enter arrow.**   
The Errors screen displays. The alphanumeric error code is listed. The error code is reported in hexadecimal format, with the first two digits identifying a specific I/O module slot. If the digits are 1F, an exact slot cannot be determined. Refer to the Fault Messages and Error Code in the appendix of this manual for a complete listing and follow the recommended action for correcting the error.
- 4 Clear the error code from the Major Error field by entering four zeros (0000) using the Select Left/Right arrows.** 
- 5 Press the Scroll Down button**   
to move to the Reset field. There are three choice available in the Reset field: Fault, Error and OK. Continue to press the Scroll down button until you reach OK.
- 6 Press the Enter button to save the reset.**   
Press the Home button to return to the home screen. 

## CLEARING CPU AND I/O ALARMS

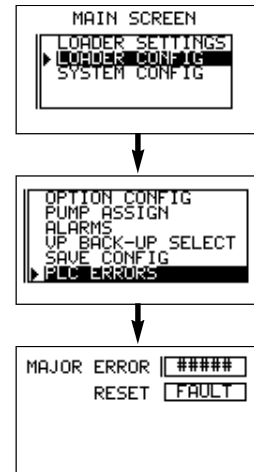

# CONVEYING SYSTEM ALARMS

The No Material Alarm can be triggered in two ways:

- The Alarm Check signals an alarm after the operator-set number of consecutive loading attempts fails to satisfy the receiver's demand for material.
- The optional fill sensor in the receiver or hopper is not satisfied after one loading cycle.

Alarm	Possible cause	Solution
No Material Alarm	There is no material at the source.	<ul style="list-style-type: none"> <li><input type="checkbox"/> Verify that there is enough material at the source, including regrind sources if a ratio valve is used.</li> <li><input type="checkbox"/> Verify that the material line is connected to the correct source of material.</li> </ul>
	Loader Settings are incorrect.	<p>If the parameters set on the Loader Settings screen are incorrect, material demand may not be satisfied.</p> <ul style="list-style-type: none"> <li><input type="checkbox"/> Verify that the Load Time, or Load Time plus Purge Time, is sufficient to fill the receiver. Adjust as needed.</li> <li><input type="checkbox"/> Verify that the Alarm Check allows a sufficient number of loading cycles to fill the receiver. Adjust as needed.</li> <li><input type="checkbox"/> Verify that the loader is assigned to the correct pump system.</li> </ul>
	There is a leak in the vacuum system.	<p>If there are leaks in the system, the pump cannot pull a good vacuum and the receiver may have no or little material flowing into it. Check the vacuum pump gauge. If the reading is low, check all hoses, gaskets, receiver lids, and valves for signs of damage or wear. Replace as needed.</p>

# CONVEYING SYSTEM ALARMS

Alarm	Possible cause	Solution
No Material Alarm (continued)	Vacuum pump is not working correctly.	Verify that the vacuum pump is on, connected to the B32 and working correctly. Refer to the pump manual.
	The fill/demand sensor or demand switch is not working properly.	<ul style="list-style-type: none"> <li><input type="checkbox"/> Verify that sensors and switches are connected correctly at the loader or hopper and at the control.</li> <li><input type="checkbox"/> Verify that fill and demand sensors are set at the correct height and adjusted properly. Refer to manuals supplied with the fill or demand signaling device.</li> </ul>
	Compressed air lines are not connected correctly.	If a compressed air line is not connected to vacuum or material valves, the valves cannot open to allow the pump to draw material into the receiver. Verify that compressed air lines supplying the correct pressure have been connected to the vacuum sequencing valve, ratio valve, pocket conveying or purge valve.
Pump Overload	The vacuum pump overload has tripped.	This alarm will prevent the pump from being energized until the overload is corrected. Refer to the pump manual to correct the problem.

# OPERATOR INTERFACE PROBLEMS



**WARNING: Electrical shock hazard**  
Diagnosing electrical and processor problems require access to the electrical enclosure while power is on. Only qualified electrical technicians, who are trained in how to avoid voltage hazards, should perform troubleshooting procedures that require access to the B32 Input/Output enclosure while power is on.

Fault	Possible cause	Solution
Terminal does not power up.	Improper connection to power source	<input type="checkbox"/> Verify wiring and connections to power source.
	Incorrect input voltage level.	<input type="checkbox"/> Verify correct voltage is present at power terminals.
	DC power wires reversed (DC terminals only).	<input type="checkbox"/> Make sure DC power positive and negative are connected to the proper terminals.
	Power terminal block not fully seated (PV300 terminals only).	<input type="checkbox"/> Verify power terminal block is snapped onto base of PV300 Micro.

# PROCESSOR AND POWER PROBLEMS



**WARNING: Electrical shock hazard**  
Diagnosing electrical and processor problems require access to the electrical enclosure while power is on. Only qualified electrical technicians, who are trained in how to avoid voltage hazards, should perform troubleshooting procedures that require access to the B32 Input/Output enclosure while power is on.

Fault	Possible cause	Solution
See <a href="#">APPENDIX C “TROUBLESHOOTING YOUR SYSTEM”</a> for a complete listing of process and power faults, causes and solutions.		



**WARNING: Electrical shock hazard**

Diagnosing electrical and processor problems require access to the electrical enclosure while power is on. Only qualified electrical technicians, who are trained in how to avoid voltage hazards, should perform troubleshooting procedures that require access to the B32 Input/Output enclosure while power is on.

## CPU FAULTS

---

Error/Alarm	Possible cause	Solution
-------------	----------------	----------

---

See [APPENDIX D: “FAULT MESSAGES AND ERROR CODES”](#) for a complete listing of CPU faults, causes and solutions.



**WARNING: Electrical shock hazard**

Diagnosing electrical and processor problems require access to the electrical enclosure while power is on. Only qualified electrical technicians, who are trained in how to avoid voltage hazards, should perform troubleshooting procedures that require access to the B32 Input/Output enclosure while power is on.

## I/O ERRORS

---

Error	Possible cause	Solution
-------	----------------	----------

---

See [APPENDIX D: “FAULT MESSAGES AND ERROR CODES”](#) for a complete listing of input/output errors, causes and solutions.

---

---

---

Conair has made the largest investment in customer support in the plastics industry. Our service experts are available to help with any problem you might have installing and operating your equipment. Your Conair sales representative also can help analyze the nature of your problem, assuring that it did not result from misapplication or improper use.

## WE'RE HERE TO HELP

To contact Customer Service personnel, call:



**From outside the United States, call: 814-437-6861**

You can commission Conair service personnel to provide on-site service by contacting the Customer Service Department. Standard rates include an on-site hourly rate, with a one-day minimum plus expenses.

## HOW TO CONTACT CUSTOMER SERVICE

**If you do have a problem, please complete the following checklist before calling Conair:**

- Make sure you have all model, serial and parts list numbers for your particular equipment. Service personnel will need this information to assist you.
- Make sure power is supplied to the equipment.
- Make sure that all connectors and wires within and between control systems and related components have been installed correctly.
- Check the troubleshooting guide of this manual for a solution.
- Thoroughly examine the instruction manual(s) for associated equipment, especially controls. Each manual may have its own troubleshooting guide to help you.
- Check that the equipment has been operated as described in this manual.
- Check accompanying schematic drawings for information on special considerations.

## BEFORE YOU CALL ...

*Additional manuals and prints for your Conair equipment may be ordered through the Customer Service or Parts Departments for a nominal fee.*

---

## EQUIPMENT GUARANTEE

Conair guarantees the machinery and equipment on this order, for a period as defined in the quotation from date of shipment, against defects in material and workmanship under the normal use and service for which it was recommended (except for parts that are typically replaced after normal usage, such as filters, liner plates, etc.). Conair's guarantee is limited to replacing, at our option, the part or parts determined by us to be defective after examination. The customer assumes the cost of transportation of the part or parts to and from the factory.

## PERFORMANCE WARRANTY

Conair warrants that this equipment will perform at or above the ratings stated in specific quotations covering the equipment or as detailed in engineering specifications, provided the equipment is applied, installed, operated and maintained in the recommended manner as outlined in our quotation or specifications.

Should performance not meet warranted levels, Conair at its discretion will exercise one of the following options:

- Inspect the equipment and perform alterations or adjustments to satisfy performance claims. (Charges for such inspections and corrections will be waived unless failure to meet warranty is due to misapplication, improper installation, poor maintenance practices or improper operation.)
- Replace the original equipment with other Conair equipment that will meet original performance claims at no extra cost to the customer.
- Refund the invoiced cost to the customer. Credit is subject to prior notice by the customer at which time a Return Goods Authorization Number (RGA) will be issued by Conair's Service Department. Returned equipment must be well crated and in proper operating condition, including all parts. Returns must be prepaid.

Purchaser must notify Conair in writing of any claim and provide a customer receipt and other evidence that a claim is being made.

## WARRANTY LIMITATIONS

**Except for the Equipment Guarantee and Performance Warranty stated above, Conair disclaims all other warranties with respect to the equipment, express or implied, arising by operation of law, course of dealing, usage of trade or otherwise, including but not limited to the implied warranties of merchantability and fitness for a particular purpose.**



The program can be restored to the plant configuration if for some reason the program has been interrupted.

To restore the program:

**1 Use the Up/Down arrows to scroll to Loader Config.**



**2 Press the Enter arrow.**

The Loader Configuration screen displays. Use the up/down arrows to scroll to Save Config



**3 Press the Enter arrow.**

The Save Configuration screen displays. Use the scroll up/down buttons to select Program Mode.



**4 Press the Enter arrow to save the change.**



**5 Press the Previous button to return to the last screen you were viewing, or the Main button to return to the Main screen.**



## RESTORING THE PROGRAM

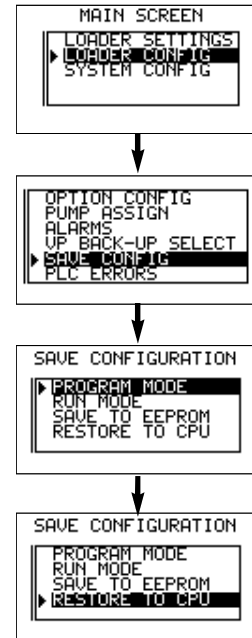

---

---

## Troubleshooting Your System

This chapter describes how to troubleshoot your controller. Topics include:

- understanding the controller LED status
- controller error recovery model
- identifying controller faults
- calling Rockwell Automation for assistance

### Understanding Controller LEDs

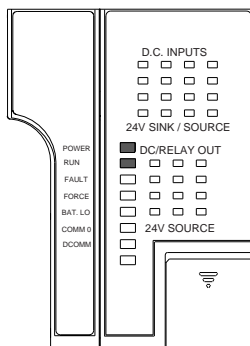

The controller status LEDs provide a mechanism to determine the current status of the controller if a programming device is not present or available.

LED	Color	Indicates
POWER	off	no input power
	green	power on
RUN	off	controller is not in Run mode or REM Run
	green	controller is in Run mode or REM Run
	green flashing	system is not in Run mode; memory module transfer is in progress
FAULT	off	no fault detected
	red flashing	faulted user program
	red	processor hardware fault or critical fault
FORCE	off	no forces installed
	amber	forces installed
BATTERY LOW	off	battery OK
	red	battery needs replacement (See page B-2.)
COMM 0	off	flashes when communications are active
	green	
COMM 1 (1764-LRP only)	off	flashes when communications are active
	green	
DCOMM <sup>(1)</sup>	off	user configured communications mode is active
	green	default communications mode active
INPUTS	off	input is not energized
	amber	input is energized (logic status)
OUTPUTS	off	output is not energized
	amber	output is energized (logic status)

(1) When using a 1764-LRP processor, the DCOMM LED applies only to Channel 0.

## When Operating Normally

The POWER and RUN LEDs are on. If a force condition is active, the FORCE LED turns on and remains on until all forces are removed.

## When an Error Exists

If an error exists within the controller, the controller LEDs operate as described in the following tables.

If the LEDS indicate:	The Following Error Exists	Probable Cause	Recommended Action
All LEDS off	No input power or power supply error	No Line Power	Verify proper line voltage and connections to the controller.
		Power Supply Overloaded	This problem can occur intermittently if power supply is overloaded when output loading and temperature varies.
Power and FAULT LEDS on solid	Hardware faulted	Processor Hardware Error	Cycle power. Contact your local Conair Service representative if the error persists.
		Loose Wiring	Verify connections to the controller.
Power LED on and FAULT LED flashing	Application fault	Hardware/ Software Major Fault Detected	<ol style="list-style-type: none"> <li>4. Monitor Status File Word S:6 for major error code. See page C-4 for more information.</li> <li>5. Remove hardware/software condition causing fault.</li> <li>6. Clear Major Error Halted flag, bit S2:1/13.</li> <li>7. Attempt a controller Run mode entry. If unsuccessful, repeat recommended action steps above or contact your Coniar Service representative.</li> </ol>

## Controller Error Recovery Model

Use the following error recovery model to help you diagnose software and hardware problems in the micro controller. The model provides common questions you might ask to help troubleshoot your system. Refer to the recommended pages within the model for further help.

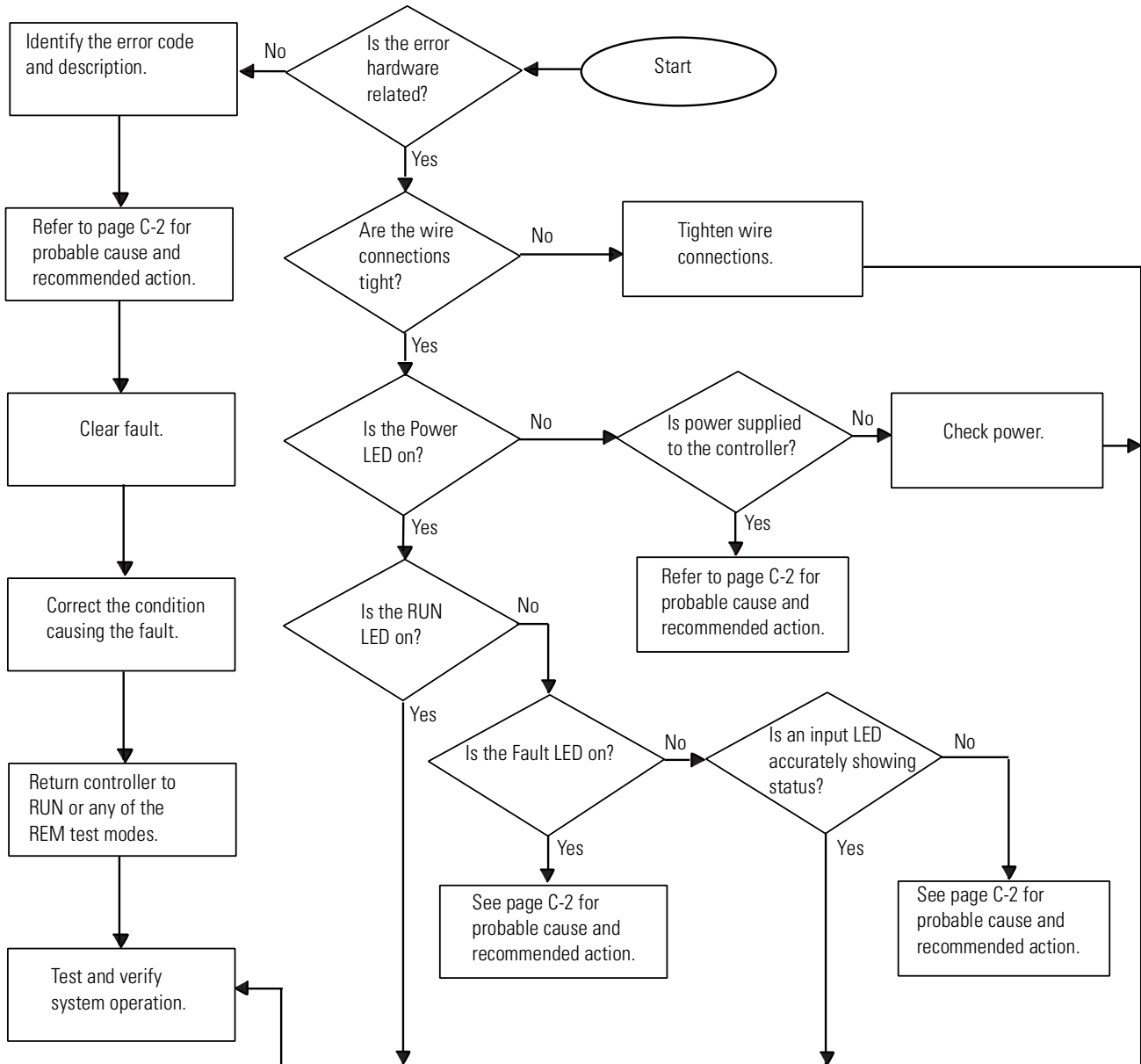

## Identifying Controller Faults

While a program is executing, a fault may occur within the operating system or your program. When a fault occurs, you have various options to determine what the fault is and how to correct it. This section describes how to clear faults and provides a list of possible advisory messages with recommended corrective actions.

### Automatically Clearing Faults

You can automatically clear a fault by cycling power to the controller when the Fault Override at Power-up bit (S:1/8) is set in the status file.

You can also configure the controller to clear faults and go to RUN every time the controller is power cycled. This is a feature that OEMs can build into their equipment to allow end users to reset the controller. If the controller faults, it can be reset by simply cycling power to the machine. To accomplish this, set the following bits in the status file:

- S2:1/8 - Fault Override at Power-up
- S2:1/12 - Mode Behavior

If the fault condition still exists after cycling power, the controller re-enters the fault mode. For more information on status bits, refer to the *MicroLogix 1200 and MicroLogix 1500 Instruction Set Reference Manual*.

**NOTE**

You can declare your own application-specific major fault by writing your own unique value to S:6 and then setting bit S:1/13 to prevent reusing system defined codes. The recommended values for user defined faults are FF00 to FF0F.

### Manually Clearing Faults Using the Fault Routine

The occurrence of recoverable or non-recoverable user faults can cause the user fault subroutine to be executed. If the fault is recoverable, the subroutine can be used to correct the problem and clear the fault bit S:1/13. The controller then continues in the Run or test mode.

The subroutine does not execute for non-user faults. Refer to the *MicroLogix 1200 and MicroLogix 1500 Instruction Set Reference Manual* for information on creating a user fault subroutine.

### Fault Messages

Refer to the *MicroLogix 1200 and 1500 Instruction Set Reference Manual* for the controller fault messages that can occur during operation of the MicroLogix 1500 programmable controllers. Each fault message includes the error code description, the probable cause, and the recommended corrective action.

## Fault Messages and Error Codes

This chapter describes how to troubleshoot your controller. Topics include:

- identifying controller faults
- contacting Rockwell Automation for assistance

### Identifying Controller Faults

While a program is executing, a fault may occur within the operating system or your program. When a fault occurs, you have various options to determine what the fault is and how to correct it. This section describes how to clear faults and provides a list of possible advisory messages with recommended corrective actions.

#### Automatically Clearing Faults

You can automatically clear a fault by cycling power to the controller when the Fault Override at Power-Up bit (S:1/8) is set in the status file.

You can also configure the controller to clear faults and go to RUN every time the controller is power cycled. This is a feature that OEMs can build into their equipment to allow end users to reset the controller. If the controller faults, it can be reset by simply cycling power to the machine. To accomplish this, set the following bits in the status file:

- S2:1/8 - Fault Override at Power-up
- S2:1/12 - Mode Behavior

If the fault condition still exists after cycling power, the controller re-enters the fault mode. For more information on status bits, see System Status File on page C-1.

**NOTE**

You can declare your own application-specific major fault by writing your own unique value to S:6 and then setting bit S:1/13 to prevent reusing system defined codes. The recommended values for user-defined faults are FF00 to FFOF.

## Manually Clearing Faults Using the Fault Routine

The occurrence of recoverable or non-recoverable user faults can cause the user fault subroutine to be executed. If the fault is recoverable, the subroutine can be used to correct the problem and clear the fault bit S:1/13. The controller then continues in the Run or test mode.

The subroutine does not execute for non-user faults. See User Fault Routine on page 18-6 for information on creating a user fault subroutine.

## Fault Messages

This section contains fault messages that can occur during operation of the MicroLogix 1200 and MicroLogix 1500 programmable controllers. Each table lists the error code description, the probable cause, and the recommended corrective action.

Error Code (Hex)	Advisory Message	Description	Fault Classification	Recommended Action
0001	NVRAM ERROR	The default program is loaded to the controller memory. This occurs: <ul style="list-style-type: none"> <li>• if a power down occurred during program download or transfer from the memory module.</li> <li>• RAM integrity test failed.</li> <li>• FLASH integrity test failed (<i>MicroLogix 1200 only</i>).</li> </ul>	Non-User	<ul style="list-style-type: none"> <li>• Re-download or transfer the program.</li> <li>• Verify battery is connected (<i>MicroLogix 1500 only</i>).</li> <li>• Contact your Conair Service representative if the error persists.</li> </ul>
0002	UNEXPECTED RESET	<ul style="list-style-type: none"> <li>• The controller was unexpectedly reset due to a noisy environment or internal hardware failure.</li> <li>• The default program is loaded. (<i>MicroLogix 1500 only</i>)</li> <li>• Retentive Data is lost. See page C-12. (<i>MicroLogix 1200 only</i>)</li> </ul>	Non-User	<ul style="list-style-type: none"> <li>• Refer to proper grounding guidelines and using surge suppressors in your controller's User Manual.</li> <li>• Verify battery is connected (<i>MicroLogix 1500 only</i>).</li> <li>• Contact your Conair service representative if the error persists.</li> </ul>
0003	MEMORY MODULE USER PROGRAM IS CORRUPT	Memory module memory error. This error can also occur when going to the Run mode.	Non-User	Re-program the memory module. If the error persists, replace the memory module.
0004	MEMORY INTEGRITY ERROR	While the controller was powered up, ROM or RAM became corrupt.	Non-User	<ul style="list-style-type: none"> <li>• Cycle power on your unit. Then, re-download your program and start up your system.</li> <li>• Refer to proper grounding guidelines and using surge suppressors in your controller's User Manual.</li> <li>• Contact your Conair Service representative if the error persists.</li> </ul>



<b>Error Code (Hex)</b>	<b>Advisory Message</b>	<b>Description</b>	<b>Fault Classification</b>	<b>Recommended Action</b>
0006	MEMORY MODULE HARDWARE FAULT	The memory module hardware faulted or the memory module is incompatible with OS.	Non-User	<ul style="list-style-type: none"> <li>• Upgrade the OS to be compatible with memory module.</li> <li>• Obtain a new memory module.</li> </ul>
0007	MEMORY MODULE TRANSFER ERROR	Failure during memory module transfer.	Non-User	Re-attempt the transfer. If the error persists, replace the memory module.
0008	FATAL INTERNAL SOFTWARE ERROR	An unexpected software error occurred.	Non-User	<ul style="list-style-type: none"> <li>• Cycle power on your unit. Then, re-download your program and re-initialize any necessary data.</li> <li>• Start up your system.</li> <li>• Refer to proper grounding guidelines and using surge suppressors in your controller's User Manual.</li> <li>• Contact your Conair Service representative if the error persists.</li> </ul>
0009	FATAL INTERNAL HARDWARE ERROR	An unexpected hardware error occurred.	Non-User	<ul style="list-style-type: none"> <li>• Cycle power on your unit. Then, re-download your program and re-initialize any necessary data.</li> <li>• Start up your system.</li> <li>• Refer to proper grounding guidelines and using surge suppressors in your controller's User Manual.</li> <li>• Contact your Conair Service representative if the error persists.</li> </ul>
000A	OS MISSING OR CORRUPT	The operating system required for the user program is corrupt or missing.	Non-User	<ul style="list-style-type: none"> <li>• Download a new OS using ControlFlash.</li> <li>• Contact your local Rockwell Automation representative for more information about available operating systems your controller.</li> </ul>
000B	BASE HARDWARE FAULT	The base hardware faulted or is incompatible with the OS.	Non-User	<ul style="list-style-type: none"> <li>• Upgrade the OS using ControlFlash.</li> <li>• Replace the Controller (<i>MicroLogix 1200 only</i>).</li> <li>• Replace the Base Unit (<i>MicroLogix 1500 only</i>).</li> <li>• Contact your Conair Service representative for more information about available operating systems your controller.</li> </ul>
0011	EXECUTABLE FILE 2 IS MISSING	Ladder File 2 is missing from the program.	Non-User	<ul style="list-style-type: none"> <li>• Re-compile and reload the program.</li> </ul>
0012	LADDER PROGRAM ERROR	The ladder program has a memory integrity problem.	Non-User	<ul style="list-style-type: none"> <li>• Reload the program or re-compile and reload the program. If the error persists, be sure to use RSI programming software to develop and load the program.</li> <li>• Refer to proper grounding guidelines and using surge suppressors in your controller's User Manual.</li> </ul>
0015	I/O CONFIGURATION FILE ERROR	The user program I/O configuration is invalid.	Non-User	Re-compile and reload the program, and enter the Run mode. If the error persists, be sure to use RSI programming software to develop and load the program.

Error Code (Hex)	Advisory Message	Description	Fault Classification	Recommended Action
0016	STARTUP PROTECTION FAULT	The user fault routine was executed at power-up, prior to the main ladder program. Bit S:1/13 (Major Error Halted) was not cleared at the end of the User Fault Routine. The User Fault Routine ran because bit S:1/9 was set at power-up.	Recoverable	<ul style="list-style-type: none"> <li>• Either reset bit S:1/9 if this is consistent with the application requirements, and change the mode back to RUN, or</li> <li>• clear S:1/13, the Major Error Halted bit, before the end of the User Fault Routine.</li> </ul>
0017	NVRAM/MEMORY MODULE USER PROGRAM MISMATCH	Bit S:2/9 is set in the controller and the memory module user program does not match the controller user program.	Non-Recoverable	Transfer the memory module program to the controller and then change to Run mode.
0018	MEMORY MODULE USER PROGRAM INCOMPATIBLE WITH OS	The user program in the memory module is incompatible with the OS.	Non-User	<ul style="list-style-type: none"> <li>• Upgrade the OS using ControlFlash to be compatible with the memory module.</li> <li>• Obtain a new memory module.</li> <li>• Contact your local Rockwell Automation representative for more information about available operating systems your controller.</li> </ul>
001A	USER PROGRAM INCOMPATIBLE WITH OS AT POWER-UP	The user program is incompatible with the OS.	Non-User	<ul style="list-style-type: none"> <li>• Upgrade the OS using ControlFlash.</li> <li>• Contact your Conair Service representative for more information about available operating systems your controller.</li> </ul>
0020	MINOR ERROR AT END-OF-SCAN DETECTED	A minor fault bit (bits 0-7) in S:5 was set at the end of scan.	Recoverable	<ul style="list-style-type: none"> <li>• Correct the instruction logic causing the error.</li> <li>• Enter the status file display in your programming software and clear the fault.</li> <li>• Enter the Run mode.</li> </ul>
0021	EXPANSION POWER FAIL (EPF) <i>(MicroLogix 1500 only)</i>	A power failure is present on the expansion I/O bank.	Non-User	Re-apply power to the expansion I/O bank. See Important note below.
		<p><b>IMPORTANT</b></p> <p>This error code is present only when the controller is powered, and power is not applied to the expansion I/O bank. This is a self-clearing error code. When power is re-applied to the expansion I/O bank, the fault is cleared. See Important note below.</p> <p>If this fault occurs while the system is in the RUN mode, the controller faults. When expansion I/O power is restored, the controller clears the fault and re-enters the RUN mode.</p> <p>If you change the mode switch while this fault is present, the controller may not re-enter the RUN mode when expansion I/O power is restored.</p> <p>If an EPF condition is present and expansion I/O power is OK, toggle the mode switch to PROGRAM and then to RUN. The fault should clear and the controller enters the RUN mode.</p>		
0022	WATCHDOG TIMER EXPIRED, SEE S:3	The program scan time exceeded the watchdog timeout value (S:3H).	Non-Recoverable	<ul style="list-style-type: none"> <li>• Determine if the program is caught in a loop and correct the problem.</li> <li>• Increase the watchdog timeout value in the status file.</li> </ul>
0023	STI ERROR	An error occurred in the STI configuration.	Recoverable	See the Error Code in the STI Function File for the specific error.

<b>Error Code (Hex)</b>	<b>Advisory Message</b>	<b>Description</b>	<b>Fault Classification</b>	<b>Recommended Action</b>
0028	INVALID OR NONEXISTENT USER FAULT ROUTINE VALUE	<ul style="list-style-type: none"> <li>• A fault routine number was entered in the status file, number (S:29), but either the fault routine was not physically created, or</li> <li>• the fault routine number was less than 3 or greater than 255.</li> </ul>	Non-User	<ul style="list-style-type: none"> <li>• Either clear the fault routine file number (S:29) in the status file, or</li> <li>• create a fault routine for the file number reference in the status file (S:29). The file number must be greater than 2 and less than 256.</li> </ul>
0029	INSTRUCTION INDIRECTION OUTSIDE OF DATA SPACE	An indirect address reference in the ladder program is outside of the entire data file space.	Recoverable	Correct the program to ensure that there are no indirect references outside data file space. Re-compile, reload the program and enter the Run mode.
002E	EII ERROR	An error occurred in the EII configuration.	Recoverable	See the Error Code in the EII Function File for the specific error.
0030	SUBROUTINE NESTING EXCEEDS LIMIT	The JSR instruction nesting level exceeded the controller memory space.	Non-User	Correct the user program to reduce the nesting levels used and to meet the restrictions for the JSR instruction. Then reload the program and Run.
0031	UNSUPPORTED INSTRUCTION DETECTED	The program contains an instruction(s) that is not supported by the controller.	Non-User	<ul style="list-style-type: none"> <li>• Modify the program so that all instructions are supported by the controller.</li> <li>• Re-compile and reload the program and enter the Run mode.</li> </ul>
0032	SQO/SQC/SQL OUTSIDE OF DATA FILE SPACE	A sequencer instruction length/position parameter references outside of the entire data file space.	Recoverable	<ul style="list-style-type: none"> <li>• Correct the program to ensure that the length and position parameters do not point outside data file space.</li> <li>• Re-compile, reload the program and enter the Run mode.</li> </ul>
0033	BSL/BSR/FFL/FFU/LFL/LFU CROSSED DATA FILE SPACE	The length/position parameter of a BSL, BSR, FFL, FFU, LFL, or LFU instruction references outside of the entire data file space.	Recoverable	<ul style="list-style-type: none"> <li>• Correct the program to ensure that the length and position parameters do not point outside of the data space.</li> <li>• Re-compile, reload the program and enter the Run mode.</li> </ul>
0034	NEGATIVE VALUE IN TIMER PRESET OR ACCUMULATOR	A negative value was loaded to a timer preset or accumulator.	Recoverable	<ul style="list-style-type: none"> <li>• If the program is moving values to the accumulated or preset word of a timer, make certain these values are not negative.</li> <li>• Reload the program and enter the Run mode.</li> </ul>
0035	ILLEGAL INSTRUCTION IN INTERRUPT FILE	The program contains a Temporary End (TND), Refresh (REF), or Service Communication instruction in an interrupt subroutine (STI, EII, HSC) or user fault routine.	Non-Recoverable	<ul style="list-style-type: none"> <li>• Correct the program.</li> <li>• Re-compile, reload the program and enter the Run mode.</li> </ul>
0036	INVALID PID PARAMETER	An invalid value is being used for a PID instruction parameter.	Recoverable	Process Control Instruction for more information about the PID instruction.
0037	HSC ERROR	An error occurred in the HSC configuration.	Recoverable	See the Error Code in the HSC Function File for the specific error.
003B	PTO ERROR	An error occurred in the PTO instruction configuration.	Recoverable or Non-User	See the Error Code in the PTO Function File for the specific error.
003C	PWM ERROR	An error occurred in the PWM instruction configuration.	Recoverable or Non-User	See the Error Code in the PWM Function File for the specific error.

Error Code (Hex)	Advisory Message	Description	Fault Classification	Recommended Action
003D	INVALID SEQUENCER LENGTH/POSITION	A sequencer instruction (SQ0, SQC, SQL) length/position parameter is greater than 255.	Recoverable	Correct the user program, then re-compile, reload the program and enter the Run mode.
003E	INVALID BIT SHIFT OR LIFO/FIFO PARAMETER	A BSR or BSL instruction length parameter is greater than 2048 or an FFU, FFL, LFU, LFL instruction length parameter is greater than 128 (word file) or greater than 64 (double word file)	Recoverable	Correct the user program or allocate more data file space using the memory map, then reload and Run.
003F	COP/FLL OUTSIDE OF DATA FILE SPACE	A COP or FLL instruction length parameter references outside of the entire data space.	Recoverable	<ul style="list-style-type: none"> <li>Correct the program to ensure that the length and parameter do not point outside of the data file space.</li> <li>Re-compile, reload the program and enter the Run mode.</li> </ul>
0050	CONTROLLER TYPE MISMATCH	A particular controller type was selected in the user program configuration, but did not match the actual controller type.	Non-User	<ul style="list-style-type: none"> <li>Connect to the hardware that is specified in the user program, or</li> <li>Reconfigure the program to match the attached hardware.</li> </ul>
0051	BASE TYPE MISMATCH	A particular hardware type (AWA, BWA, BXB) was selected in the user program configuration, but did not match the actual base.	Non-User	<ul style="list-style-type: none"> <li>Connect to the hardware that is specified in the user program, or</li> <li>Reconfigure the program to match the attached hardware.</li> </ul>
0052	MINIMUM SERIES ERROR	The hardware minimum series selected in the user program configuration was greater than the series on the actual hardware.	Non-User	<ul style="list-style-type: none"> <li>Connect to the hardware that is specified in the user program, or</li> <li>Reconfigure the program to match the attached hardware.</li> </ul>
0070	EXPANSION I/O TERMINATOR REMOVED <i>(MicroLogix 1500 only)</i>	The required expansion I/O terminator was removed.	Non-Recoverable	<ul style="list-style-type: none"> <li>Check the expansion I/O terminator on the last I/O module.</li> <li>Cycle power.</li> </ul>
xx71 <sup>(1)</sup>	EXPANSION I/O HARDWARE ERROR	The controller cannot communicate with an expansion I/O module.	Non-Recoverable	<ul style="list-style-type: none"> <li>Check connections.</li> <li>Check for a noise problem and be sure proper grounding practices are used.</li> <li>Replace the module.</li> <li>Cycle power.</li> </ul>
xx79 <sup>(1)</sup>	EXPANSION I/O MODULE ERROR	An expansion I/O module generated an error.	Non-Recoverable	<ul style="list-style-type: none"> <li>Refer to the I/O Module Status (IOS) file.</li> <li>Consult the documentation for your specific I/O module to determine possible causes of a module error.</li> </ul>
0080	EXPANSION I/O TERMINATOR REMOVED <i>(MicroLogix 1500 only)</i>	The required expansion I/O terminator was removed.	Non-User	<ul style="list-style-type: none"> <li>Check expansion I/O terminator on last I/O module.</li> <li>Cycle power.</li> </ul>
xx81 <sup>(1)</sup>	EXPANSION I/O HARDWARE ERROR	The controller cannot communicate with an expansion I/O module.	Non-User	<ul style="list-style-type: none"> <li>Check connections.</li> <li>Check for a noise problem and be sure proper grounding practices are used.</li> <li>Replace the module.</li> <li>Cycle power.</li> </ul>

<b>Error Code (Hex)</b>	<b>Advisory Message</b>	<b>Description</b>	<b>Fault Classification</b>	<b>Recommended Action</b>
0083	MAX I/O CABLES EXCEEDED	The maximum number of expansion I/O cables allowed was exceeded.	Non-User	<ul style="list-style-type: none"> <li>• Reconfigure the expansion I/O system so that it has an allowable number of cables.</li> <li>• Cycle power.</li> </ul>
0084	MAX I/O POWER SUPPLIES EXCEEDED	The maximum number of expansion I/O power supplies allowed was exceeded.	Non-User	<ul style="list-style-type: none"> <li>• Reconfigure the expansion I/O system so that it has the correct number of power supplies.</li> </ul>
0085	MAX I/O MODULES EXCEEDED	The maximum number of expansion I/O modules allowed was exceeded.	Non-User	<ul style="list-style-type: none"> <li>• Reconfigure the expansion I/O system so that it has an allowable number of modules.</li> <li>• Cycle power.</li> </ul>
xx86 <sup>(1)</sup>	EXPANSION I/O MODULE BAUD RATE ERROR	An expansion I/O module could not communicate at the baud rate specified in the user program I/O configuration.	Non-User	<ul style="list-style-type: none"> <li>• Change the baud rate in the user program I/O configuration, and</li> <li>• Re-compile, reload the program and enter the Run mode, or</li> <li>• Replace the module.</li> <li>• Cycle power.</li> </ul>
xx87 <sup>(1)</sup>	I/O CONFIGURATION MISMATCH	<ul style="list-style-type: none"> <li>• The expansion I/O configuration in the user program did not match the actual configuration, or</li> <li>• The expansion I/O configuration in the user program specified a module, but one was not found, or</li> <li>• The expansion I/O module configuration data size for a module was greater than what the module is capable of holding.</li> </ul>	Non-User	<ul style="list-style-type: none"> <li>• Either correct the user program I/O configuration to match the actual configuration, or</li> <li>• With power off, correct the actual I/O configuration to match the user program configuration.</li> </ul>
xx88 <sup>(1)</sup>	EXPANSION I/O MODULE CONFIGURATION ERROR	The number of input or output image words configured in the user program exceeds the image size in the expansion I/O module.	Non-User	<ul style="list-style-type: none"> <li>• Correct the user program I/O configuration to reduce the number of input or output words, and</li> <li>• Re-compile, reload the program and enter the Run mode.</li> </ul>
xx89 <sup>(1)(2)</sup>	EXPANSION I/O MODULE ERROR	An expansion I/O module generated an error.	Non-User	<ul style="list-style-type: none"> <li>• Refer to the I/O status file.</li> <li>• Consult the documentation for your specific I/O module to determine possible causes of a module error.</li> </ul>
xx8A <sup>(1)(2)</sup>	EXPANSION I/O CABLE CONFIGURATION MISMATCH ERROR	<ul style="list-style-type: none"> <li>• Either an expansion I/O cable is configured in the user program, but no cable is present, or</li> <li>• an expansion I/O cable is configured in the user program and a cable is physically present, but the types do not match.</li> </ul>	Non-User	<ul style="list-style-type: none"> <li>• Correct the user program to eliminate a cable that is not present</li> <li>• Re-compile, reload the program and enter the Run mode, or</li> <li>• Add the missing cable.</li> <li>• Cycle power.</li> </ul>

Error Code (Hex)	Advisory Message	Description	Fault Classification	Recommended Action
xx8B <sup>(1)(2)</sup>	EXPANSION I/O POWER SUPPLY CONFIGURATION MISMATCH ERROR	<ul style="list-style-type: none"> <li>• Either an expansion I/O power supply is configured in the user program, but no power supply is present, or</li> <li>• an expansion I/O power supply is configured in the user program and a power supply is physically present, but the types do not match.</li> </ul>	Non-User	<ul style="list-style-type: none"> <li>• Correct the user program to eliminate a power supply that is not present</li> <li>• Re-compile, reload the program and enter the Run mode, or</li> <li>• With power removed, add the missing power supply.</li> </ul>
xx8C <sup>(1)(2)</sup>	EXPANSION I/O OBJECT TYPE MISMATCH	An expansion I/O object (i.e. cable, power supply, or module) in the user program I/O configuration is not the same object type as is physically present.	Non-User	<ul style="list-style-type: none"> <li>• Correct the user program I/O configuration so that the object types match the actual configuration, and</li> <li>• Re-compile, reload the program and enter the Run mode. Or</li> <li>• Correct the actual configuration to match the user program I/O configuration.</li> <li>• Cycle power.</li> </ul>
0x1F39	INVALID STRING LENGTH <sup>(3)</sup>	The first word of string data contains a negative, zero, or value greater than 82.	Recoverable	Check the first word of the string data element for invalid values and correct the data.

(1) xx indicates module number. If xx = 0, problem cannot be traced to a specific module.

(2) The xx in this error code means that the error occurs at the location of the last properly configured Expansion I/O module +1. You should use this information in conjunction with the specific error code to determine the source of the problem.

(3) Applies to MicroLogix 1500 1764-LSP Series B and 1764-LRP Processors.