

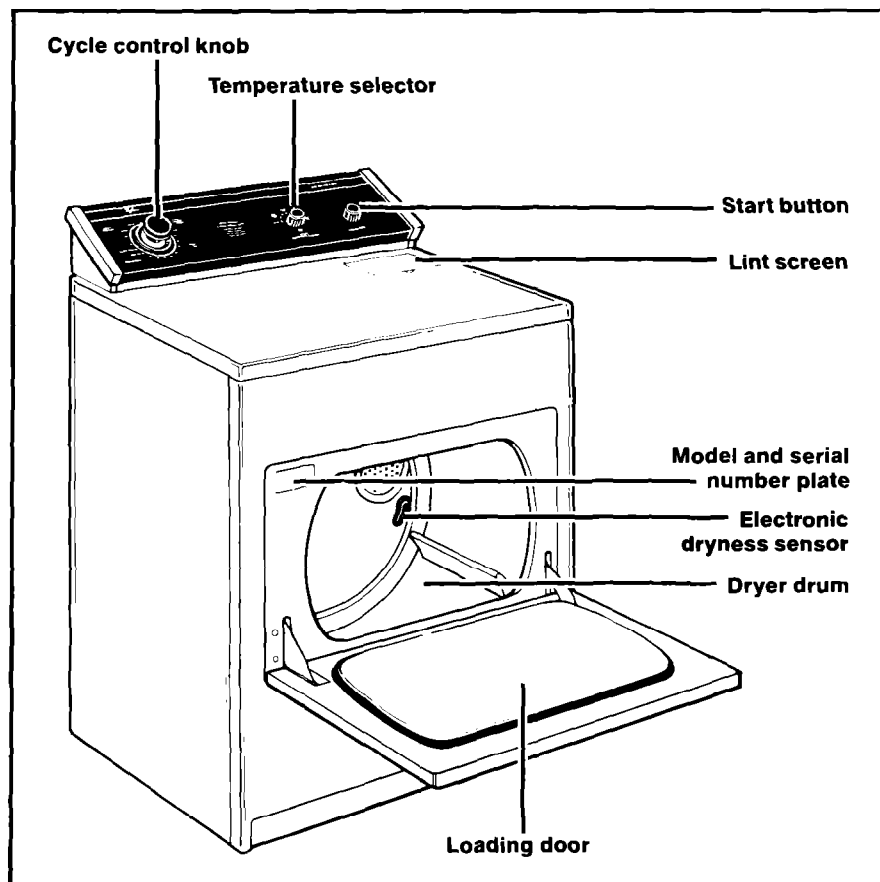

Use & Care Guide



SUPER CAPACITY AUTOMATIC DRYERS

LE6098XS LE6880XS LE7080XS LE7680XS LE7800XS
LG6099XS LG6881XS LG7081XS LG7681XS LG7801XS

Contents

	Page
Important Safety Instructions	3
Additional safety instructions and your responsibilities	3
Operating Instructions	
Starting your dryer	4-5
The automatic cycles	6
Timed drying	7
Using FLUFF AIR	7
Using TUMBLE PRESS®	7
Using DAMP DRY	8
End-of-cycle signal	8
Lint signal	8
Additional Dryer Features	
Gentle Heat System	9
FINISH GUARD® setting	9
Caring for Your Dryer	
Cleaning the lint screen	10
Cleaning the dryer interior	10-11
Lint removal	11
If You Need Service or Assistance	12-13
Whirlpool Warranty	16

©1988 Whirlpool Corporation

Remove the Consumer Buy Guide label. It will be easier to remove before the dryer is used. To remove any remaining glue:

- Rub briskly with thumb to make a ball, then remove.
- or
- Soak area with liquid hand dishwashing detergent before removing glue as described above.

Do not use rubbing alcohol or flammable or toxic solvents, such as acetone, gasoline, carbon tetrachloride, etc. These can damage the finish.

NOTE: Do not remove any permanent instruction labels inside the dryer.

You should wipe out the dryer drum with a damp cloth before using to remove dust from storing or shipping.

Thank you for buying a Whirlpool appliance. Please complete and mail the Owner Registration Card provided with this product. Then complete the form below. Have this information ready if you need service or call with a question.

- Copy model and serial numbers from plate (on the frame behind the door) and purchase date from sales slip.
- Keep this book, the Dryer Guide and the sales slip together in a handy place.

Model Number

Serial Number

Purchase Date

Service Company Phone Number

FOR YOUR SAFETY

If you smell gas:

- 1. Open windows.**
- 2. Don't touch electrical switches.**
- 3. Extinguish any open flame.**
- 4. Immediately call your gas supplier.**

FOR YOUR SAFETY

Do not store or use gasoline or other flammable vapors and liquids in the vicinity of this or any other appliance. The fumes can create a fire hazard or explosion.

Important Safety Instructions

⚠ WARNING

To reduce the risk of fire, electrical shock, or injury to persons when using your dryer, follow basic precautions, including the following:

- **Read these laundry instructions for important use and safety information before using your dryer.**
- **NEVER** dry items cleaned, washed, soaked in or spotted with wax, paint, gasoline or flammable fluids in the dryer. The fumes can create a **FIRE HAZARD** or **EXPLOSION. ALWAYS** hand launder and air dry fabrics containing these materials.
- **NEVER** allow children to operate, play with or crawl inside the dryer. Close supervision of children is necessary when the dryer is used near children.
- **DO NOT** reach into a dryer if the drum is moving.
- When discarding an old dryer, **ALWAYS** remove the door to prevent accidental entrapment.
- **DO NOT** install or store dryer where it will be exposed to the weather.
- **DO NOT** tamper with the controls.
- **You are personally responsible for making sure that your dryer** is installed, repaired and parts replaced by a qualified person.
- Use only fabric softeners specifically labeled as not being harmful to the dryer.
- **FIRE HAZARD** and **DAMAGE** to materials can result from:
 - drying rubber, rubber-like and heat sensitive materials with heat.
 - allowing lint build-up inside the dryer or exhaust system. Cleaning should be done periodically by a qualified person.
- Clean lint screen before or after each load.
- **DO NOT** let dust, lint, paper, rags, chemicals, etc. pile up around or under the dryer.
- Dryer must be electrically grounded. See the Installation Instructions.

– SAVE THESE INSTRUCTIONS –

Additional safety instructions and your responsibilities

- **NEVER** operate the dryer if:
 - it is not working right (i.e. noisy, too hot).
 - it is damaged.
 - parts are missing (i.e. door latch).
 - all panels are not in place.
 - the lint screen is loose, damaged or missing.
 - **ALWAYS** shut off the gas valve before leaving on vacation if you have a gas dryer.
 - **ALWAYS** unplug the power supply cord or turn off electrical power before attempting to service the dryer. Shut off GAS VALVE if you have a gas dryer.
 - **You are personally responsible for making sure that your dryer:**
 - is properly maintained.
 - is properly installed and leveled on a floor that can support the weight in a well ventilated room.*
 - is located in an area where the temperature is above 45°F (7.2°C).
 - is connected to the proper outlet and electrical supply.*
 - is properly connected to fuel and exhaust systems.*
 - is not installed against drapes or curtains.*
 - is used only for jobs normally expected of home clothes dryers.
 - is not used by anyone unable to operate it properly.
- *See the Installation Instructions for complete information.

Operating Instructions

Starting your dryer

Be sure to refer to the chart below and the Dryer Guide for proper sorting, loading and control setting information before starting it.

TYPE OF LOAD	SUGGESTED CYCLE	SUGGESTED TEMPERATURE
Cottons and linens		
EXTRA HEAVY – Bedspreads, mattress pads, quilts	AUTOMATIC REGULAR	HEAVY HIGH
HEAVYWEIGHT – Towels, jeans, corduroys, work clothes		PERM'T PRESS MED
MEDIUMWEIGHT – Sheets, pillowcases, cotton, underwear, diapers		
LIGHTWEIGHT – Batistes, organdies, lingerie		MEDIUM LOW
Permanent press, synthetics and blends		
HEAVYWEIGHT – Work clothes, jackets, raincoats	AUTOMATIC PERMANENT PRESS	PERM'T PRESS MED
MEDIUMWEIGHT – Shirts, play clothes, sheets, slacks		MEDIUM LOW
LIGHTWEIGHT – Lingerie, blouses, dresses		KNITS GENTLE LOW
Knits		
HEAVYWEIGHT – Cottons, rayons, blends, T-shirts, slacks, shirts	AUTOMATIC PERMANENT PRESS	MEDIUM LOW
LIGHTWEIGHT – Synthetic (polyester, acrylic, etc.) and blends, lingerie, blouses, dresses		KNITS GENTLE LOW
Delicate fabrics		
Sheer curtains (2 or 3 panels), gauze, lace, etc.	AUTOMATIC PERMANENT PRESS	EX LOW

WARNING

Drying these and other heat-sensitive materials with heat can damage them or be a FIRE HAZARD.

Rubber, plastic, heat-sensitive fabrics

FOAM RUBBER – Pillows, bras, stuffed toys	FLUFF AIR
PLASTIC – Shower curtains, tablecloths	
RUBBER-BACKED RUGS	
OLEFIN, POLYPROPYLENE, SHEER NYLON	

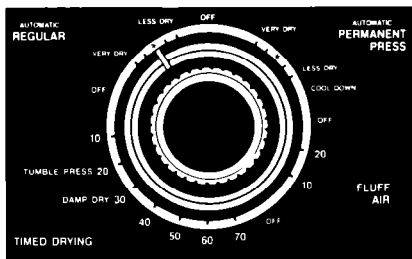

1. Select a cycle by turning the Cycle Control Knob either way to point to the cycle and setting you want. See pages 6-8 for further cycle information.

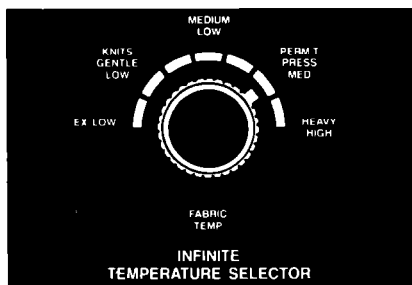

2. Set the Temperature Selector on or between any desired temperature settings.

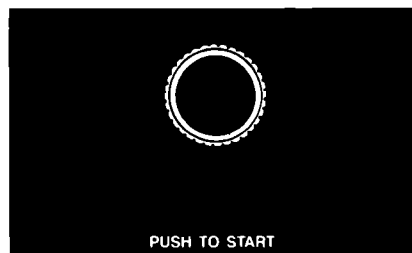

3. Push the Start Button to start the dryer.

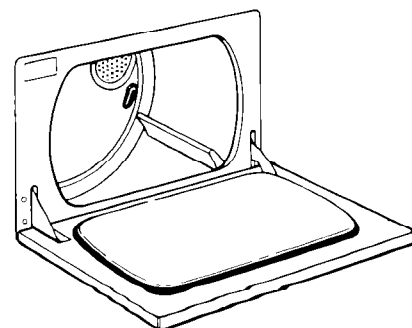

4. To stop and restart the dryer:

- Open the door or turn the Cycle Control Knob to OFF to stop the dryer.
- Close the door, select a cycle (if necessary) and push the Start Button to restart the dryer.

The Cycle Control Knob should point to an OFF area when the dryer is not in use. If the dryer is stopped before the cycle is finished, turn the Cycle Control Knob to an OFF area.

Operating Instructions Continued

The automatic cycles

The automatic cycles allow you to select the degree of dryness you prefer for the clothes being dried.

The automatic DRY-MISER® control is a thermostat that senses the dryer air temperature. The dryer automatically shuts off when the selected dryness is reached.

The Cycle Control Knob will not move until the clothes load is almost dry, or the Cool-Down portion of the cycle has been reached. After the Cool-Down portion is complete, the Cycle Control Knob automatically moves to an OFF area and tumbling stops.



Use **AUTOMATIC REGULAR** to dry heavy and mediumweight cotton items. The load tumbles without heat during the last 5 minutes. This helps make the load easier to handle.

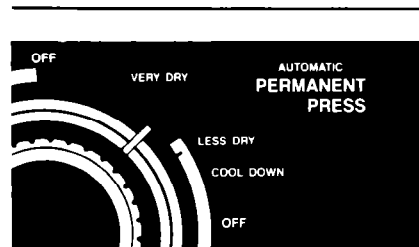

Use **AUTOMATIC PERMANENT PRESS** to dry permanent press, knits and other synthetic items. The load tumbles without heat during the last 10 minutes. This helps keep wrinkles from setting in and makes the load easier to handle.

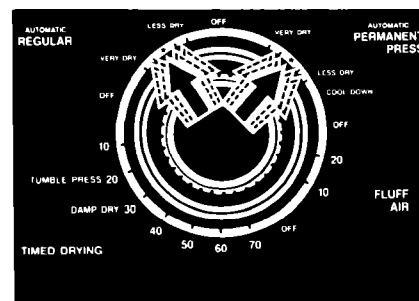

For the first few loads, set the Cycle Control Knob to point to an ★ in either automatic cycle. When the dryer stops, feel the dried items.

- If items are drier than you like, use a setting to the right of the ★ the next time you dry a similar load.
- If items are not as dry as you like, use a setting to the left of the ★ the next time you dry a similar load.

NOTE: Overdrying can cause shrinkage, static cling and damage to some fabrics.

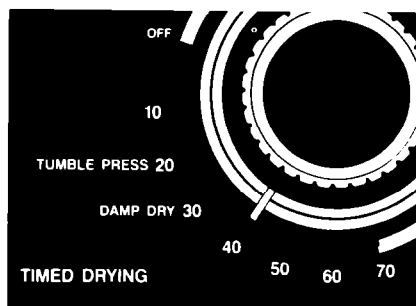

Timed drying

Use the TIMED DRYING cycle for any load you want to dry by time.

- Turn the Cycle Control Knob to the number of minutes you want from 10 to 70.

The last 5 minutes of this cycle are without heat to help make the load easier to handle.

⚠ WARNING

Drying plastic or rubber items with heat may damage the items or be a FIRE HAZARD.

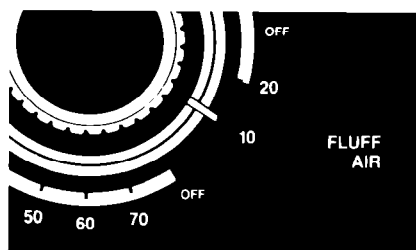

Using FLUFF AIR

The dryer does not heat when the Cycle Control Knob is set in FLUFF AIR. This cycle can be used to fluff or air dry bedding, plastic tablecloths, foam rubber pillows, stuffed toys, sneakers, etc.

1. Turn the Cycle Control Knob to the number of minutes you want in FLUFF AIR.
2. Push the Start Button.

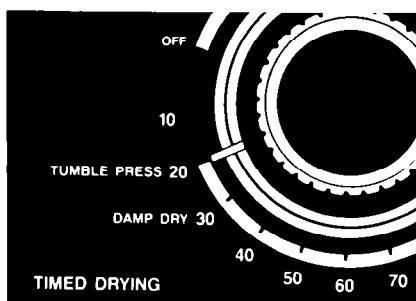

Using TUMBLE PRESS[®]

The TUMBLE PRESS setting removes wrinkles from clothing such as items that may have been packed in a suitcase, closet or items not removed from the dryer.

1. Set the Cycle Control Knob on TUMBLE PRESS.
2. Set the Temperature Selector on PERMIT PRESS MED.
3. Push the Start Button.

The load will tumble in heated air for 15 minutes. Then the dryer will tumble the clothes for 5 more minutes without heat.

For best results, put only a few items at a time in this cycle. As soon as the dryer stops, put the items on hangers or fold them.

Operating Instructions Continued

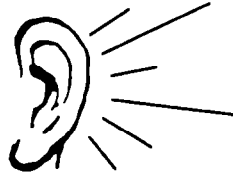
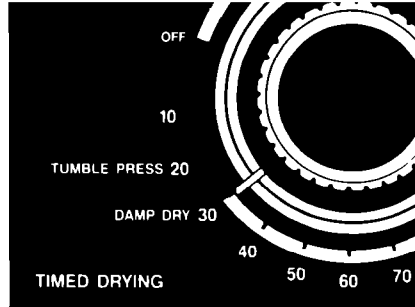

Using DAMP DRY

This setting should be used for damp items that do not require an entire drying cycle.

1. Set the Cycle Control Knob on DAMP DRY in the TIMED DRYING cycle.
2. Push the Start Button.

The dryer tumbles the load with heat for 25 minutes, then without heat for 5 minutes.

End-of-cycle signal

The dryer sounds a signal to let you know when the cycle is finished. The signal cannot be turned off and is not adjustable.

The signal is helpful when you are drying permanent press, synthetic and other items that should be taken out as soon as the dryer stops.

Lint signal

Clean the lint screen before each load. If you neglect to clean your lint screen, the signal will sound. The (whistle tone) signal lets you know the air flow is being restricted. Restricted air flow reduces drying efficiency.

Turn off the dryer and clean the lint screen as shown on page 10.

Additional Dryer Features

Gentle Heat System

The dryer automatically reduces the heat settings in HEAVY HIGH and PERM'T PRESS MED. During the last few minutes of each of these temperature settings the dryer temperature gradually reduces to a lower heat setting. This helps prevent overdrying.

FINISH GUARD® setting

(Models LE7800XS and LG7801XS only)

When you are unable to remove a load from the dryer as soon as it stops, wrinkles can form.

If you don't open the door within 5 minutes after the PERMANENT PRESS cycle stops, FINISH GUARD takes over automatically to protect the load. You don't have to set the Cycle Control Knob for FINISH GUARD.

FINISH GUARD tumbles the load, without heat, every 5 minutes for up to 40 minutes. This tumbling rearranges and fluffs the load to help avoid wrinkles that set in when the load remains in the drum.

Caring For Your Dryer

Cleaning the lint screen

The lint screen is located under a lid on top of the dryer. **Clean it before each load.** A screen blocked by lint can increase drying time.

⚠ WARNING

Do not run the dryer with the lint screen loose, damaged, blocked or missing. Doing so can cause overheating, damage fabrics and be a FIRE HAZARD.

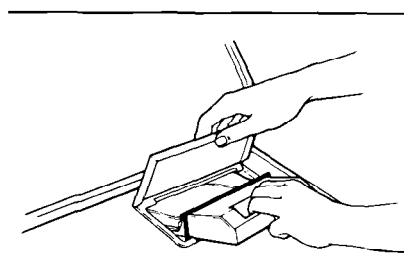

1. Open the lid and pull the lint screen straight out.

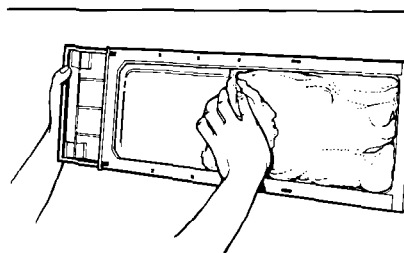

2. Roll lint off the screen with your fingers. **Do not** rinse or wash the screen. Wet lint is hard to remove.
3. Push the lint screen firmly back into place and close the lid.

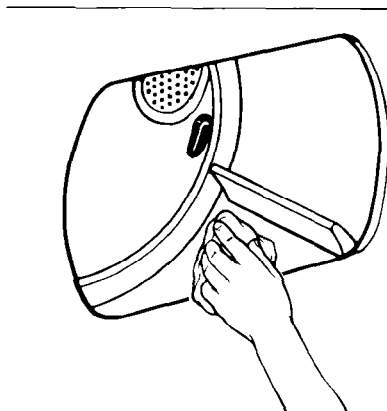

Cleaning the dryer interior

⚠ WARNING

Electric shock hazard. Unplug the power supply cord or turn off the electrical power before cleaning the interior. Failure to do so could result in electrical shock or injury.

Garments which contain unstable dyes, such as denim blue jeans or brightly colored cotton items, may discolor the dryer interior. If the interior is discolored, clean with one of the following methods to avoid staining later load items.

Caring For Your Dryer Continued

Powdered laundry detergent

Make a paste with detergent and very warm water. Apply paste to a soft cloth and scrub area until all excess dye is removed. Wipe thoroughly with a damp cloth. Tumble a load of rags to dry.

– OR –

Liquid household cleaner

Apply to stained area. Rub with a cloth until all excess dye is removed. Tumble a load of rags to dry.

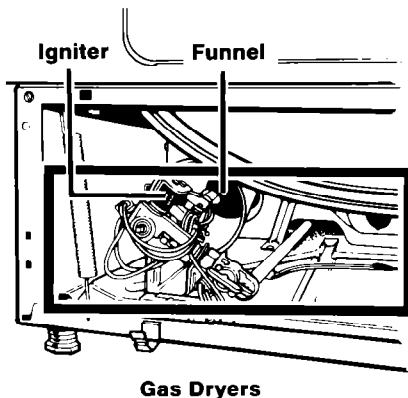
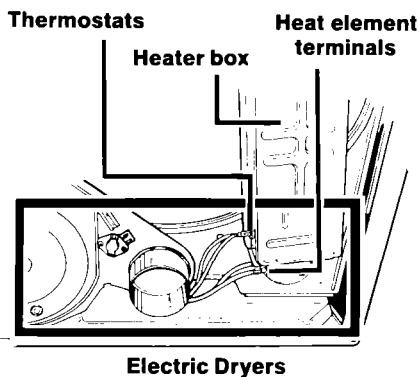

Lint removal

Lint can gather inside the dryer and create a **FIRE HAZARD**. This lint should be removed at least every **2 to 3 years, or more often, depending on dryer usage.**

⚠ WARNING

Electrical shock hazard.

- Unplug the power supply cord or turn off the electrical power.
- Do not put hands inside the cabinet.
- Make sure the dryer is cool.

Failure to do so could result in electrical shock, injury or damage.

Cleaning should be done only by a qualified person.

1. Remove back panel (electric) or lower access panel (gas).
2. Avoid damaging wires, thermostats, funnel or igniter.
3. Remove lint from boxed-in area with a soft brush or vacuum cleaner.
4. Replace panel; reconnect and relevel the dryer.

If You Need Service Or Assistance

We suggest you follow these five steps:

1. Before calling for assistance...

Performance problems often result from little things you can find and fix yourself without tools of any kind.

If your dryer does not run:

- Is the power supply plugged into a live circuit with the proper voltage?
- Is the door closed tightly?
- Did you push the Start Button?
- Have you checked your home's main fuses or circuit breaker box?

If your dryer does not heat:

- The FLUFF AIR cycle is without heat.
- The last minutes of heat settings are without heat.
- Is the gas turned on? If not, turn the Cycle Control Knob to OFF. Turn on gas. Wait 5 minutes. Reset controls and start.
- An electric dryer uses a circuit breaker or 2 fuses. If one fuse is blown, the dryer may run, but not heat.

If drying time seems too long.

- Is the lint screen clean? See page 9 for cleaning instructions.
- See the Dryer Guide.

2. If you need assistance*..

**Call Whirlpool COOL-LINE® service assistance telephone number. Dial free from anywhere in the U.S.:
1-800-253-1301**

and talk with one of our trained consultants. The consultants can instruct you in how to obtain satisfactory operation from your appliance or, if service is necessary, recommend a qualified service company in your area.

3. If you need service*..



Whirlpool has a nationwide network of franchised TECH-CARE® Service companies. TECH-

CARE service technicians are trained to fulfill the product warranty and provide after-warranty service, anywhere in the United States. To locate TECH-CARE service in your area, call our COOL-LINE service assistance telephone number (see Step 2) or look in your telephone directory Yellow Pages under:

APPLIANCES - HOUSEHOLD - MAJOR - SERVICE & REPAIR ELECTRICAL APPLIANCES - MAJOR - REPAIRING & PARTS
OR
WASHING MACHINES, DRYERS & IRONERS - SERVICING
WHIRLPOOL APPLIANCES FRANCHISED TECH-CARE SERVICE
SERVICE COMPANIES
XYZ SERVICE CO 999-9999
123 MAPLE

4. If you have a problem*..

Call our COOL-LINE service assistance telephone number (see Step 2) and talk with one of our consultants, or if you prefer, write to:

Mr. Donald Skinner
Director of Customer Relations
Whirlpool Corporation
2000 M-63
Benton Harbor, MI 49022

**5. If you need FSP*
replacement parts*..**

FSP is a registered trademark of Whirlpool Corporation for quality parts. Look for this symbol of quality whenever you need a replacement part for your Whirlpool appliance. FSP replacement parts will fit right and work right, because they are made to the same exacting specifications used to build every new Whirlpool appliance.

To locate FSP replacement parts in your area, refer to Step 3 or call the Whirlpool COOL-LINE service assistance number in Step 2.

*If you must call or write, please provide: model number, serial number, date of purchase, and a complete description of the problem. This information is needed in order to better respond to your request for assistance.

Whirlpool® Automatic Dryer Warranty

DR001

LENGTH OF WARRANTY	WHIRLPOOL WILL PAY FOR
FULL ONE-YEAR WARRANTY From Date of Purchase	FSP* replacement parts and repair labor to correct defects in materials or workmanship. Service must be provided by a franchised TECH-CARE® service company.
WHIRLPOOL WILL NOT PAY FOR	
<p>A. Service calls to:</p> <ol style="list-style-type: none">1. Correct the installation of the dryer.2. Instruct you how to use the dryer.3. Replace house fuses or correct house wiring or plumbing.4. Replace light bulbs. <p>B. Repairs when dryer is used in other than normal, single-family household use.</p> <p>C. Pick up and delivery. This product is designed to be repaired in the home.</p> <p>D. Damage to dryer caused by accident, misuse, fire, flood, acts of God or use of products not approved by Whirlpool.</p>	

WHIRLPOOL CORPORATION SHALL NOT BE LIABLE FOR INCIDENTAL OR CONSEQUENTIAL DAMAGES. Some states do not allow the exclusion or limitation of incidental or consequential damages so this limitation or exclusion may not apply to you. This warranty gives you specific legal rights, and you may also have other rights which vary from state to state.

Outside the United States, a different warranty may apply. For details, please contact your franchised Whirlpool distributor or military exchange.

