

**BenQ**

FP241VW

24" Wide-Screen LCD Monitor

User Manual

**Welcome**

# Copyright

Copyright © 2007 by BenQ Corporation. All rights reserved. No part of this publication may be reproduced, transmitted, transcribed, stored in a retrieval system or translated into any language or computer language, in any form or by any means, electronic, mechanical, magnetic, optical, chemical, manual or otherwise, without the prior written permission of BenQ Corporation.

# Disclaimer

BenQ Corporation makes no representations or warranties, either expressed or implied, with respect to the contents hereof and specifically disclaims any warranties, merchantability or fitness for any particular purpose. Further, BenQ Corporation reserves the right to revise this publication and to make changes from time to time in the contents hereof without obligation of BenQ Corporation to notify any person of such revision or changes.

# Please follow these safety instructions for best performance, and long life for your monitor

## Power Safety

- The AC plug isolates this equipment from the AC supply.
- The power supply cord serves as a power disconnect device for pluggable equipment. The socket outlet should be installed near the equipment and be easily accessible.
- This product should be operated from the type of power indicated on the marked label. If you are not sure of the type of power available, consult your dealer or local power company.

## Care And Cleaning

- Cleaning. Always unplug your monitor from the wall outlet before cleaning. Clean the LCD monitor surface with a lint-free, non-abrasive cloth. Avoid using any liquid, aerosol or glass cleaners.
- Slots and openings on the back or top of the cabinet are for ventilation. They must not be blocked or covered. Your monitor should never be placed near or over a radiator or heat source, or in a built-in installation unless proper ventilation is provided.
- Never push objects or spill liquid of any kind into this product.

## Servicing

- Do not attempt to service this product yourself, as opening or removing covers may expose you to dangerous voltages or other risks. If any of the above mentioned misuse or other accident such as dropping or mishandling occurs, contact qualified service personnel for servicing.





# Table of Contents



<b>Getting started</b> .....	<b>4</b>
<b>Getting to know your monitor</b> .....	<b>6</b>
Front view (1) .....	6
Front view (2) .....	7
Left-side view .....	7
Back view (1) .....	8
Back view(2): locations of plugs & sockets .....	8
<b>How to assemble your monitor hardware</b> .....	<b>9</b>
Adjusting the monitor angle .....	11
Detaching the top-mount monitor shelf .....	12
Using the monitor wall mounting kit .....	12
<b>Getting the most from your BenQ monitor</b> .....	<b>14</b>
How to install the monitor on a new computer .....	16
How to upgrade the monitor on an existing computer .....	17
How to install on Windows Vista systems .....	18
How to install on Windows XP system .....	19
<b>How to adjust the screen resolution</b> .....	<b>20</b>
<b>How to adjust the screen refresh rate</b> .....	<b>21</b>
<b>Picture optimization</b> .....	<b>22</b>
<b>How to adjust your monitor</b> .....	<b>23</b>
The control panel .....	23
On Screen Display (OSD) menu structure .....	24
Hot key mode .....	26
Main menu mode .....	30
<b>Troubleshooting</b> .....	<b>43</b>
Frequently asked questions (FAQ) .....	43
Need more help? .....	44
<b>Supported PC Timings</b> .....	<b>45</b>
<b>Specifications</b> .....	<b>46</b>

# 1. Getting started

Your FP241VW will provide the optimal display performance of the video resolution standard of 1920 x 1200. Please ensure that your graphic card supports the resolution of 1920 x 1200.

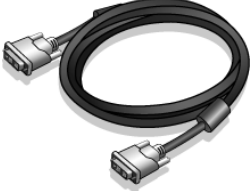
When unpacking please check you have the following items. If any are missing or damaged, please contact the place of purchase for a replacement.

BenQ LCD Monitor	 A BenQ LCD monitor with a black bezel and a silver base. The BenQ logo is visible on the bottom bezel.
Top-Mount Monitor Shelf	 A long, thin, silver-colored metal shelf designed to hold a monitor from the top.
CD-ROM and Quick Start Guide	 A CD-ROM disc and a small booklet, likely the Quick Start Guide, with a BenQ logo on the cover.
Power Cord (Picture may differ from product supplied for your region)	 A black power cord with a standard AC power plug on one end and a DC power connector on the other.
Signal Cable: D-Sub	 A black D-Sub signal cable with a 15-pin connector on one end and a DVI connector on the other.
Signal Cable: DVI-D (optional)	 A black DVI-D signal cable with DVI-D connectors on both ends.

USB cable (optional)	
HDMI cable (optional)	

 Consider keeping the box and packaging in storage for use in the future when you may need to transport the monitor. The fitted foam packing is ideal for protecting the monitor during transport.

## 2. Getting to know your monitor

### Front view (1)

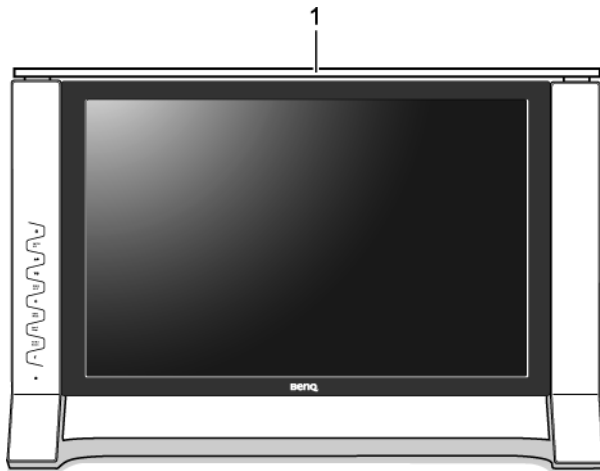

#### 1. Top-mount monitor shelf

The detachable shelf is space saving and stylishly designed, gaining extra desk space for you.

You can put small stationery items or toy collectibles on the shelf to keep the desk roomy.

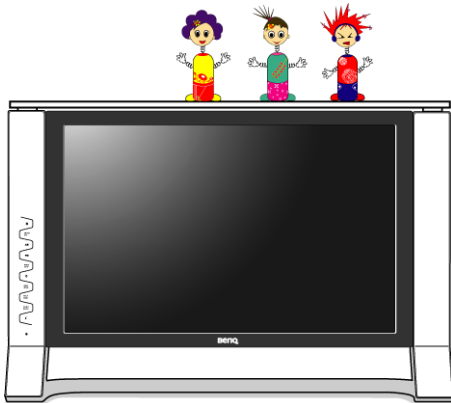

The two hooks on the rear of the allow you to hang accessories on hand, such as the headset, the game gear, etc.



**!** Never place cans of beer, soda, glasses of water or anything wet near or on top of the shelf!

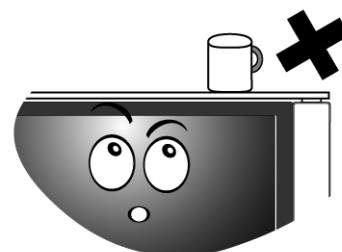
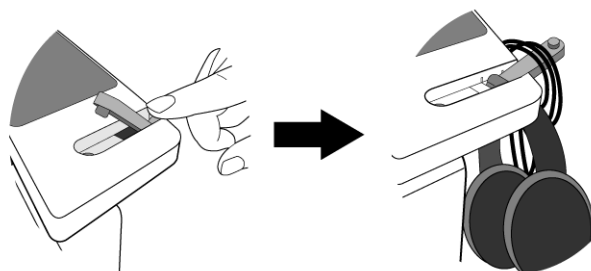

**!** If you have any need to shift the monitor around, please remove the top-mount monitor shelf first. See also [Detaching the top-mount monitor shelf on page 12](#).

## Front view (2)

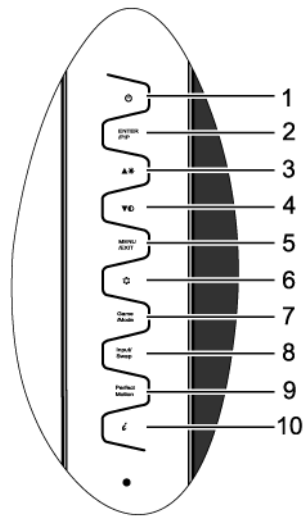

1. Power
2. ENTER / PIP
3. ▲ / Brightness
4. ▼ / Contrast
5. MENU / EXIT
6. Mode
7. Game Mode
8. Input / Swap
9. PerfectMotion
10. *i* key

 For more information about these keys, please refer to [The control panel on page 23](#).

## Left-side view

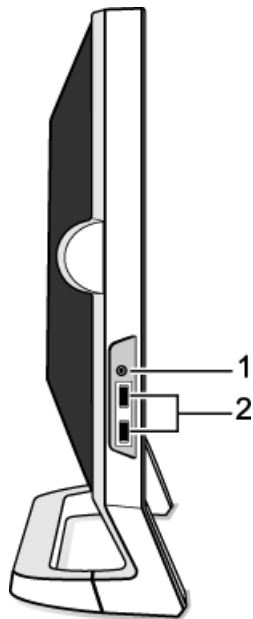

1. Earphone socket

 Plug the earphone or headset into the earphone socket to receive the audio signal from HDMI input. See [Audio menu on page 39](#) for information about audio controls.

2. USB device ports for connection to built-in USB hub

## Back view (1)

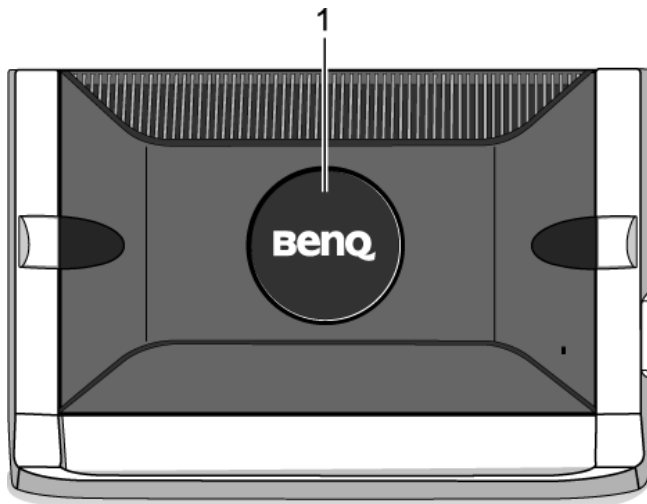

### 1. Rear cover: VESA mount inside

The back of your LCD monitor has a VESA standard mount with 100mm pattern, allowing the installation of a wall mount bracket.

See [Using the monitor wall mounting kit on page 12](#) to learn more.

## Back view(2): locations of plugs & sockets

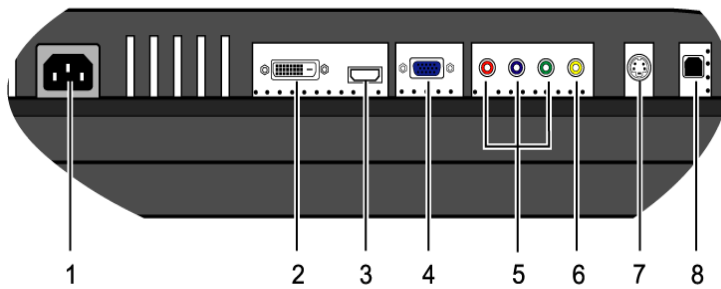

1. Power AC input connector
2. DVI-D input connector
3. HDMI input connector
4. D-Sub input connector
5. Component input connector
6. Composite input connector
7. S-Video input connector
8. USB hub socket for connection to computer USB port



### 3. How to assemble your monitor hardware

 If the computer is turned on you must turn it off before continuing.  
Do not plug-in or turn-on the power to the monitor until instructed to do so.

1. Unpack the monitor and place it on a stable surface.

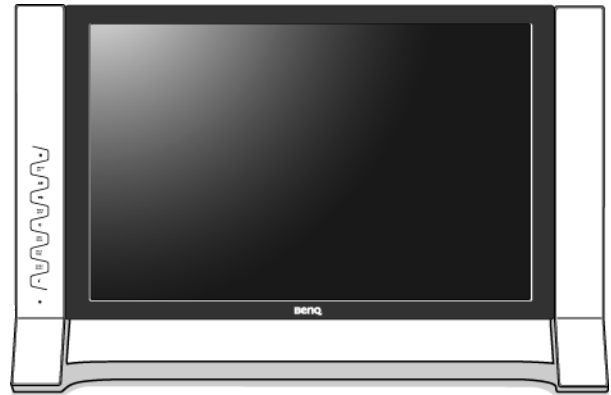

2. Connect the PC video cable.

 Do not use both DVI-D cable and D-Sub cable on the same PC. The only case in which both cables can be used is if they are connected to two different PCs with appropriate video systems.

Connect one end of the DVI-D cable to the monitor DVI-D socket and the other end to the DVI-D port on your computer. (optional)

 The DVI-D format is used for direct digital connection between source video and digital LCD monitors or projectors. The digital video signals produce a superior quality picture than analog video signals.

Connect the plug of the D-Sub cable (at the end without the ferrite filter) to the monitor D-Sub socket. Connect the other plug of the D-Sub cable (at the end with the ferrite filter) to the computer video D-Sub socket.

Tighten all finger screws to prevent the plugs from accidentally falling out during use.

3. Connect the USB hub cable.

Connect the USB cable between the USB socket on the rear of the monitor and a USB port on your computer.

**Either**

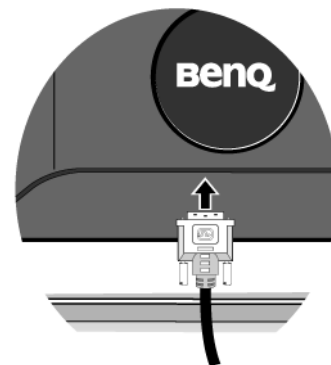

**Or**

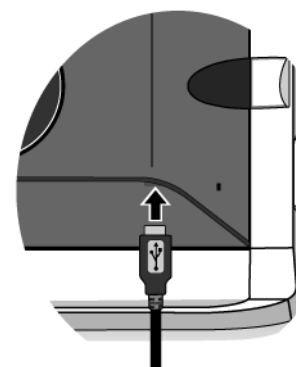
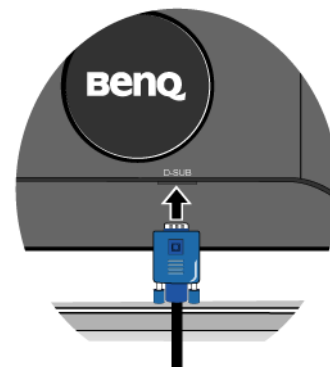

4. Connect the power cable to the monitor.

Plug one end of the power cord into the socket labelled 'POWER IN' on the rear of the monitor. Do not connect the other end to an electric outlet just yet.

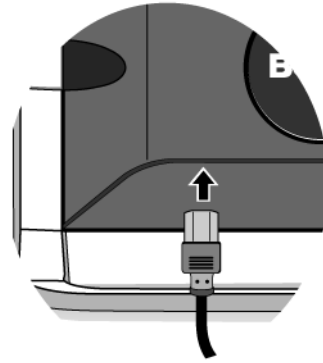



5. Attach the top-mount monitor shelf.

Fit the tenon joints at the rear of the shelf to the mortises on top of the monitor.

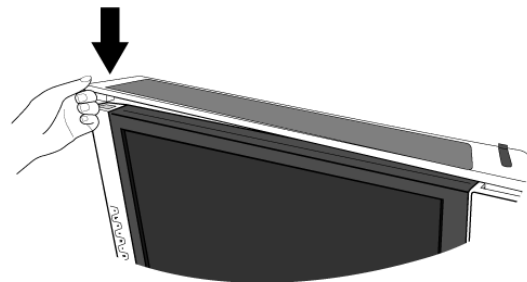
You can put small stationery items or toy collectibles on the shelf to keep the desk roomy. The two hooks on the rear of the shelf allow you to hang accessories on hand, such as the headset, the game gear, etc.



 The shelf can support objects with a total weight of up to 1kg, otherwise the shelf may be bent.

 **Never place cans of beer, soda, glasses of water or anything wet near or on top of the shelf!**

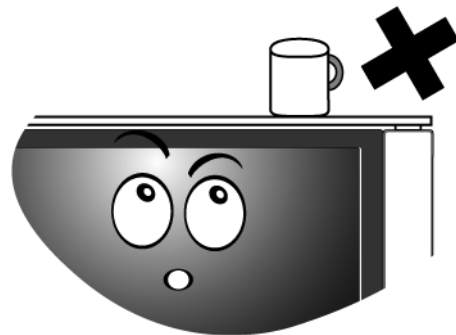



 **If you have any need to shift the monitor around, please remove the top-mount monitor shelf first. See also [Detaching the top-mount monitor shelf on page 12](#).**

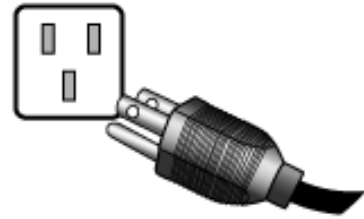

6. Turn on the power.

Connect the other end of power cable to the nearby electric outlet.



 Picture may differ from product supplied for your region.

Turn on the monitor by pressing the power key.

Turn on the computer too, and follow the instructions in Section 4: **Getting the most from your BenQ monitor on page 14** to install the monitor software.

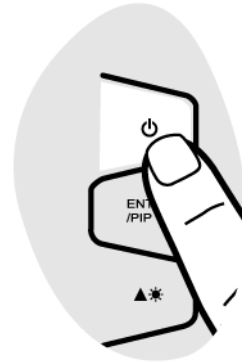

## Adjusting the monitor angle

For comfortable viewing of images on the screen, you may tilt the monitor upward to 12 degrees and downward to -5 degrees.

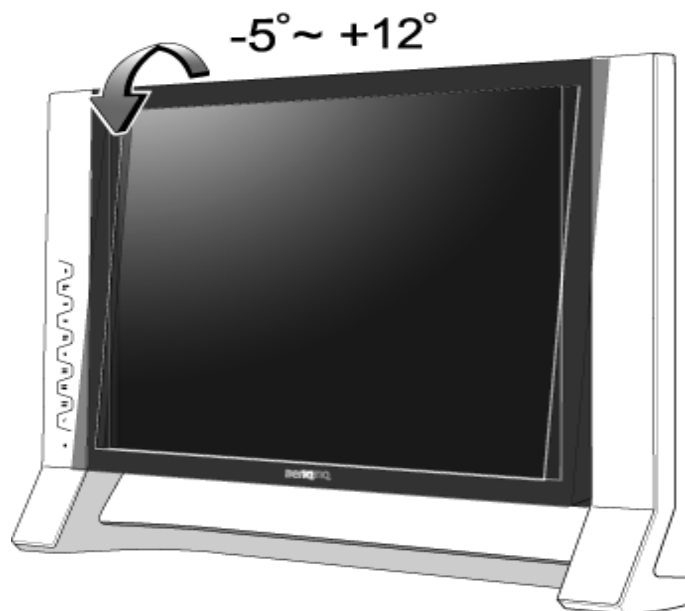

## Detaching the top-mount monitor shelf

It's easy to detach the top-mount monitor shelf from the monitor and no removal tool is needed. Before you begin, take away all the items displayed or hung on the shelf.

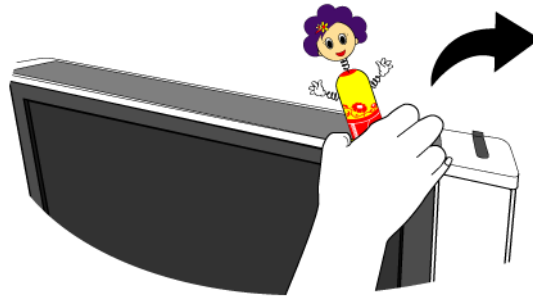

Then, hold both sides of the shelf assembly and gently pull the it upward away from the monitor.

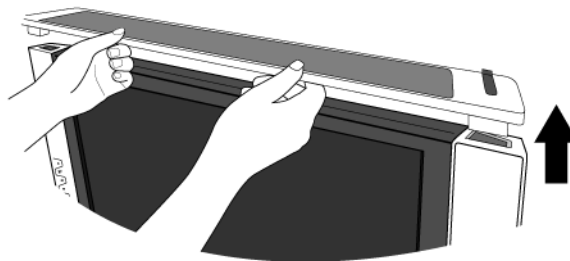

## Using the monitor wall mounting kit

The back of your LCD monitor has a VESA standard mount with 100mm pattern, allowing the installation of a wall mount bracket. Before starting to install a monitor wall mounting kit, please read the precautions carefully.

### Precautions:

- Install your monitor and monitor mounting kit on a wall with flat surface.
- Ensure that the wall material is stable to support the weight of the monitor.
- Turn off the monitor and the power before disconnecting the cables from the LCD monitor.

#### 1. Remove the rear cover.

Gently push the rear cover and rotate it counterclockwise until the rear cover unlocks. The screw plate at the back of the monitor could be revealed.



Keep the rear cover somewhere safe for future storage.



2. Follow the instruction manuals of the wall mount bracket you purchased to complete the installation.

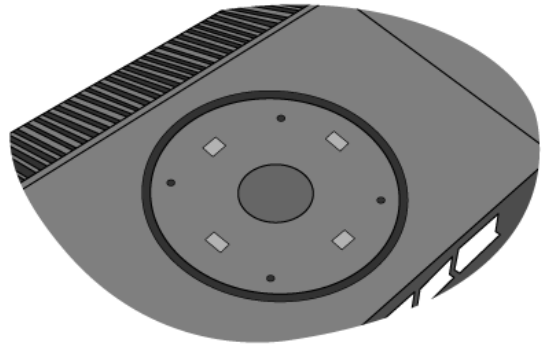

## 4. Getting the most from your BenQ monitor

### Monitors and USB hubs

Your BenQ FP241VW LCD Monitor is a modern state-of-the-art device. It not only utilizes the latest LCD display technology currently available – it contains a built-in 2 port USB 2.0 hub. Using only one USB 2.0 port on your computer (freeing the others up for other uses), the built-in hub provides close, handy, easy-to-use access for your USB devices. You could use the USB hub to plug-in your USB keyboard, USB mouse, and USB web camera all at the same time if you wish. Or if you connect your keyboard and mouse directly to your computer, you could use the USB ports on the monitor for connection to your digital camera, digital video camera, USB reader, USB printer, USB memory stick, or any other USB device.

### What do I have to do?

All you have to do, is connect the monitor cables as instructed in How to install your monitor hardware of this User Manual, turn the computer and monitor on, then you're ready to Plug-and-Play with USB, Windows, and your BenQ LCD Monitor's USB hub. Windows XP and later comes with integrated USB support. It will automatically detect and identify your USB devices, and install the necessary drivers for them to work. If your USB device was accompanied by the manufacturer's driver or custom software for the device, you need only point Windows in the direction of that driver, and Windows will install it for you.

### How do I gain the most benefit from my new monitor?

To gain the most benefit from your new BenQ color LCD flat screen monitor, you should set the graphics card to the native resolution of 1920 x 1200 at first, and then you may start to install the custom BenQ LCD Monitor driver software as provided on the BenQ LCD Monitor CD-ROM.

The circumstances under which you connect and install your BenQ LCD Monitor will determine which process you need to follow to successfully install the BenQ LCD Monitor driver software. These circumstances relate to which version of Microsoft Windows you are using, and whether you are connecting the monitor and installing the software onto a new computer (without existing monitor driver software), or whether you are upgrading an existing installation (which already has existing monitor driver software) with a newer monitor.

In either case however, the very next time you turn on your computer (after connecting the monitor to your computer), Windows will automatically recognise the new (or different) hardware, and will launch its **Found New Hardware** wizard.

Follow the wizard instructions until it asks you to select a monitor model. At that point, click the **Have Disk** button, insert the BenQ LCD Monitor CD-ROM and select the appropriate monitor model. Further details and step-by-step instructions for both an automatic (new) or upgrade (existing) installation follow. See:

- [How to install the monitor on a new computer on page 16.](#)
- [How to upgrade the monitor on an existing computer on page 17](#)

☞ If you require a User Name and Password to login to your Windows computer, you must be logged on as an Administrator or as a member of the Administrators group in order to install the monitor driver software. Furthermore, if your computer is connected to a network which has security access requirements, network policy settings may prevent you from installing software on your computer.

## How to install the monitor on a new computer

This instruction details the procedure for selecting and installing the BenQ LCD Monitor driver software on a new computer which has never had a monitor driver installed before. This instruction is only suitable for a computer which has never been used before, and for which the BenQ LCD Monitor is the first ever monitor to be connected to it.

 If you are adding the BenQ LCD Monitor to an existing computer that has already had another monitor connected to it (and has monitor driver software installed), you should not be following these instructions. You should instead be following the instructions for How to upgrade the monitor on an existing computer.

1. Follow the instructions in [How to assemble your monitor hardware on page 9](#).

When Windows starts, it will automatically detect the new monitor and launch the **Found New Hardware Wizard**. Follow the prompts until it displays the option to **Install Hardware Device drivers**.

2. Insert the BenQ LCD Monitor CD-ROM into a CD drive on the computer.
3. Check **Search for a suitable driver for my device** option, and click **Next**.
4. Check the option for **CD-ROM drives** (uncheck all others) and click **Next**.
5. Look to confirm that the wizard has selected the correct name of your monitor as “BenQ FP241VW” and click **Next**.
6. Click **Finish**.
7. Restart the computer.



## How to upgrade the monitor on an existing computer

This instruction details the procedure for manually updating the existing monitor driver software on your Microsoft Windows computer. It is currently tested as compatible (and recommended only) for Windows XP and Windows Vista Operating System (OS).

 The BenQ LCD Monitor driver for your model may well function perfectly with other versions of Windows, however, as at the time of writing, BenQ has done no testing of this driver on other versions of Windows and cannot guarantee its operation on those systems.

Installing monitor driver software involves selecting an appropriate information file (.inf) on the BenQ LCD Monitor CD-ROM for the particular model monitor you have connected, and letting Windows install the corresponding driver files from the CD. You need only steer it in the right direction.

See:

- [How to install on Windows Vista systems on page 18.](#)
- [How to install on Windows XP system on page 19](#)

## How to install on Windows Vista systems

1. Open **Display Settings**.

Right-click the desktop and select **Personalize** from the popup menu.

Select **Display Settings** from the **Personalize appearance and sounds** window.

The **Display Settings** window will display.

2. Click the **Advanced Settings** button.

The **Generic PnP Monitor Properties** window will display.

3. Click the **Monitor** tab and the **Properties** button.

4. Click **Continue** in the prompted **User Account Control** window.

5. Click the **Driver** tab and the **Update Driver** button.

6. Insert the BenQ LCD Monitor CD-ROM into a CD drive on the computer.

7. In the **Update Driver Software** window, select the option '**Browse my computer for driver software**'.

8. Click '**Browse**' and select **Driver > Windows Vista > FP241VW** from the CD, and click the **Next** button.

This will copy and install the appropriate monitor driver files to your computer.

9. Click **Close**.

You do not need to restart Windows Vista, as the BenQ LCD monitor drivers will operate immediately with no further action required by you.

## How to install on Windows XP system

### 1. Open **Display Properties**.

The quickest shortcut to **Display Properties** is through the Windows desktop. Right-click the desktop and select **Properties** from the popup menu.

Alternatively, the Windows menu to **Display Properties** is located in **Control Panel**.

In Windows XP version, **Control Panel** is located directly under the main **Start** menu item. The menu options displayed will depend upon which type of view is selected for your system.

- Under the Classic view, click **Start | Control Panel | Display**.
- Under the Category view, click **Start | Control Panel | Appearance and Themes | Change the screen resolution**.

The **Display Properties** window will display.

### 2. Click the **Settings** tab and the **Advanced** button.

The **Advanced Display Properties** window will display.

### 3. Click the **Monitor** tab and select the 'Plug and Play Monitor' from the list.

If there is only one monitor in the list, it will already be selected for you.

### 4. Click the **Properties** button.

The **Monitor Properties** window will display.

If the driver provider is listed as BenQ, and the model matches that of your new monitor, the proper drivers are already installed, and you need do nothing further. Cancel out of these property windows.

However, if BenQ is not listed as the manufacturer, or the correct model is not currently shown, you will need to continue with these instructions.

### 5. Click the **Driver** tab and the **Update Driver** button.

The **Hardware Update Wizard** will display. Follow the wizard instructions noting the steps below:

### 6. Insert the BenQ LCD Monitor CD-ROM into a CD drive on the computer.

### 7. Check the option '**Install from a list or specific location**' and click **Next**.

### 8. Check the option '**Search for the best driver in these locations**' and also check '**Search removable media**', then click **Next**.

Please wait while the wizard searches for drives and the BenQ LCD Monitor CD inserted in step 6.

When completes, the wizard should have found and selected the BenQ driver on the CD appropriate to your monitor model, in this case 'BenQ FP241VW' in the location 'd:\Driver\Windows XP\FP241VW\BenQFP241VW.inf' or similar.

 The drive letter for your CD drive may differ from the example above depending upon your system – it may be 'D:' or 'E:' or 'F:' etc.

### 9. Select (single-click) the file named '**BenQ FP241VW**' on the CD, and click the **Next** button.

This will copy and install the appropriate monitor driver files to your computer.

### 10. Click **Finish**.

This will close the wizard and return you to the **Monitor Properties** window, now renamed **BenQ FP241VW Properties**.

### 11. Click **Close**, **OK**, and **OK**.

This will close the **Display Properties** windows. You do not need to restart Windows XP, as the BenQ LCD monitor drivers will operate immediately with no further action required by you.

## 5. How to adjust the screen resolution

Due to the nature of liquid crystal display (LCD) technology, the screen resolution is always fixed. The best possible picture for your FP241VW is achieved with a resolution of 1920 x 1200. This is called “Native Resolution” or maximal resolution – that is, the clearest picture. Lower resolutions are displayed on a full screen through an interpolation circuit. Image blurring across pixel boundaries can occur with the interpolated resolution depending upon the image type and its initial resolution.

 To take full advantage of LCD technology you should select the native resolution setting of 1920 x 1200 on your PC screen resolution setting as described below. Be aware that not all PC video cards provide this resolution value. If your doesn't, check with the video card manufacturer's website for an updated driver for your particular model PC video card which supports this resolution. Software video drivers are often updated and available for new hardware video resolutions. If necessary, you may need to replace and update the PC video card hardware to be able to support the native resolution of the monitor.

1. Open **Display Properties** and select the **Settings** tab.

You can open **Display Properties** by right-clicking on the Windows desktop and selecting **Properties** from the pop-up menu.

2. Use the slider in the ‘Screen area’ section to adjust the screen resolution.

Select the recommended resolution of 1920 x 1200 then click **Apply**.

 If you select some other resolution, be aware that this other resolution is interpolated and may not accurately display the screen image as well as it could do at the native resolution setting.

3. Click **OK** then **Yes**.
4. Close the **Display Properties** window.

## 6. How to adjust the screen refresh rate

You don't have to choose the highest possible refresh rate on an LCD display, because it is not technically possible for an LCD display to flicker. The best results are obtained by using the factory modes already set in your computer. There is a table with the factory modes in the specification section of this User Manual: [Supported PC Timings on page 45](#)





You can choose 60, 70 and 75 Hertz, (but not 72Hz) for the native resolution of 1920 x 1200.

1. Double click the **Display** icon in **Control Panel**.
2. From the **Display Properties** window, select the **Settings** tab and click the **Advanced** button.
3. Select the **Adapter** tab, and select an appropriate refresh rate to match one of the applicable factory modes as listed in the specification table.
4. Click **Change**, **OK**, then **Yes**.
5. Close the **Display Properties** window.

## 7. Picture optimization

The easiest way to obtain an optimal display from an analog (D-Sub) input is to use the *i* key function. Press the *i* key to optimize the currently displayed image to the screen.

 When you connect a digital video output using a digital (DVI) cable to your monitor, the *i* key and the **Auto Adjustment** function will be disabled, because the monitor will automatically display the best image.

 Please ensure that the connected graphic card on your computer is set to the native resolution of the monitor (1920 x 1200) when you use the *i* key function.

If you wish, you can always adjust the screen geometric settings manually using geometry menu items. To assist you in this endeavour, BenQ has provided a screen test image utility which you can use to check for screen color, grayscale and line gradient display.

1. Run the test program auto.exe from CD-ROM. You could also use any other image, such as the desktop of your operating system. However, we recommend that you use auto.exe. As you run auto.exe, a test pattern displays.
2. Press the *i* key on the monitor.
3. Press the **MENU** key to access the monitor On-Screen Display (OSD) menu.
4. Use the **▲** or **▼** keys to select **DISPLAY** and press the **ENTER** key to enter the menu.
5. If you notice a vertical noise (like a curtain effect-shimmering of vertical lines), press the **▲** or **▼** keys to select **Pixel Clock** and press the **ENTER** key. Then press the **▲** or **▼** keys to adjust the monitor until the noise disappears.
6. If you notice a horizontal noise, press the **▲** or **▼** keys to select **Phase** and press the **ENTER** key. Then press the **▲** or **▼** keys adjust the monitor until the noise disappears.

## 8. How to adjust your monitor

### The control panel

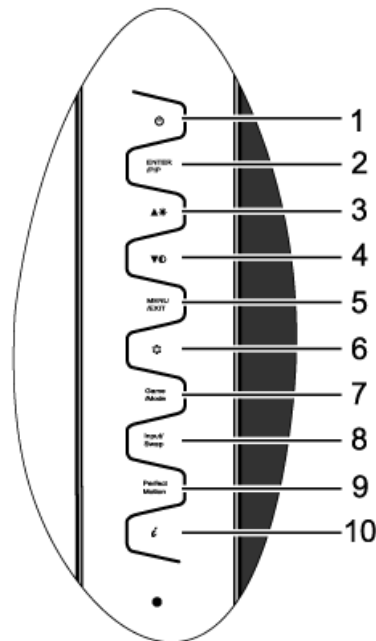

1. “Power”: Turn the power on or off.
2. “ENTER/PIP” key: Enter sub menus and select items. The key is also the hot key for activating the PIP (Picture-in-Picture) function and selecting a video input source for the PIP window.
3. ▲ (Up) key: For Up/Increase adjustment. The key is also the hot key for **Brightness**.
4. ▼ (Down) key: For Down/Decrease adjustment. The key is also the hot key for **Contrast**.
5. “MENU/EXIT” key: Activate OSD main menu and return to the previous menu or exit OSD.
6. “Mode” key: Switch between different modes, including **Standard**, **Movie**, **Dynamics**, **Photo**, **Action Game**, and **Racing Game**.
7. “Game Mode” key: Switch between different modes, including **Standard**, **Action Game**, and **Racing Game**.
8. “Input /Swap” key: Manually switch between different video signals that may be connected to your monitor for the main window, or swap the input signals between the main window and the PIP window.
9. “PerfectMotion” key: Activate the **PerfectMotion** function. It is recommended that you use this function specially when you are viewing dynamic contents, such as movies, games, etc.
10. “i key”: Adjust vertical position, phase, horizontal position and pixel clock automatically.



OSD = On Screen Display.

The hot-keys will display a graduated scale for adjusting the value of that setting, and will only operate while the OSD menu is not currently displaying. Hot-key displays will disappear after a few seconds of no key activity. See [Hot key mode on page 26](#).

## On Screen Display (OSD) menu structure

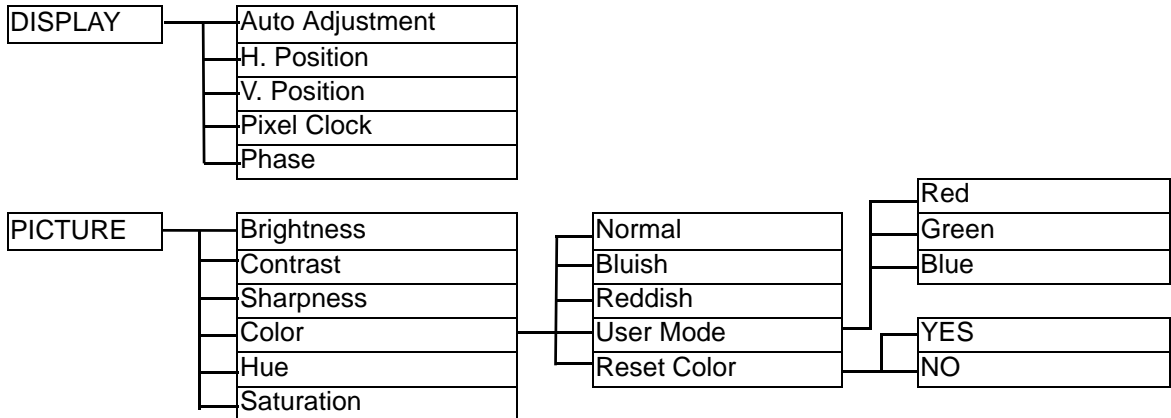

☞ **Hue** and **Saturation** are not available for use when the input source is D-Sub or DVI-D.

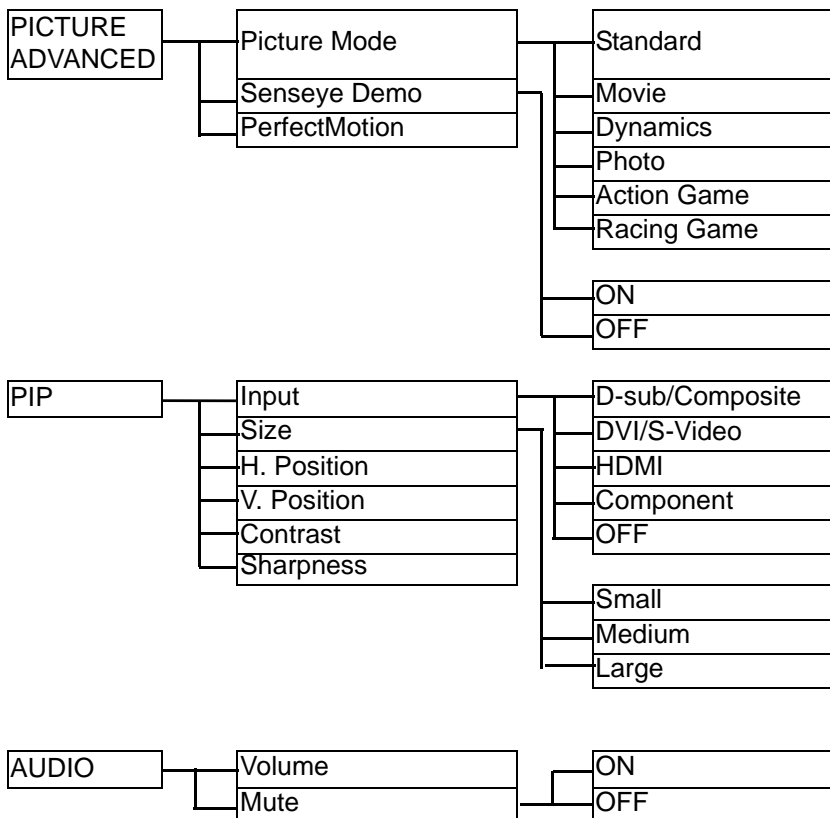

☞ The **Audio** menu is only available when the HDMI cable is connected to the monitor and HDMI is set to be the input signal for the main window.



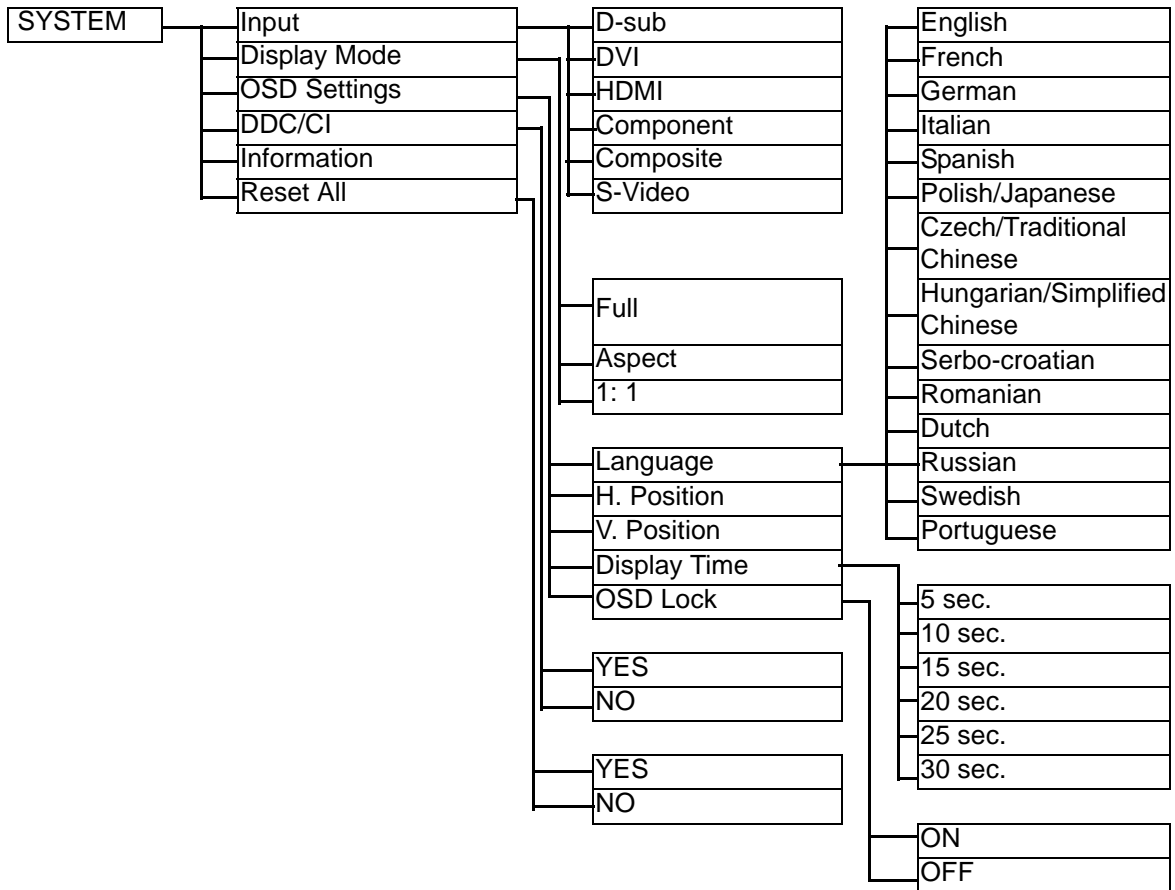

## Hot key mode

The monitor keys perform as hot keys to provide direct access to particular functions whenever the menu isn't currently displaying on-screen.

### Brightness hot key



Press the **▲** key to display the **Brightness** indicator. Further press the **▲** key to increase or the **▼** key to decrease the screen brightness, and press the **MENU** key to exit.

### Contrast hot key



Press the **▼** key to display the **Contrast** indicator. Further press the **▲** key to increase or the **▼** key to decrease the screen contrast, and press the **MENU** key to exit.

### PIP hot key





Press the **Enter** key to activate the picture in picture display and select the picture in picture display source.

Pressing this key continually allows you to switch between the video input sources or turn the **PIP** function off.

When the messages of the desired input source displays, release the key to set the PIP input source. The message will last around 3 seconds.

The setting will take effect immediately.

 This command can bring up a window from a second image source. Thus you can watch images from 1 computer graphic/PC video source (D-sub, DVI, HDMI\*, or Component) and 1 video source (Composite or S-video). The PIP function will not allow for 2 computer graphic/PC video sources or 2 video sources to perform PIP.

 \*HDMI, short for High Definition Multimedia Interface, is the first industry-supported, uncompressed, all-digital audio/video interface between audio/video sources and audio and/or video monitors. Being different from other connectors, an HDMI connector can carry both video and audio signals via the same cable and transfer uncompressed digital audio and video for the highest image quality. It supports digital televisions (DTV), set-top boxes, DVD players, and DVD recorders, etc.

- If the input source of the main window is from the computer graphic/PC video signals (D-sub, DVI, HDMI, or Component), you will cycle through the following messages indicating the video input sources for the PIP window.

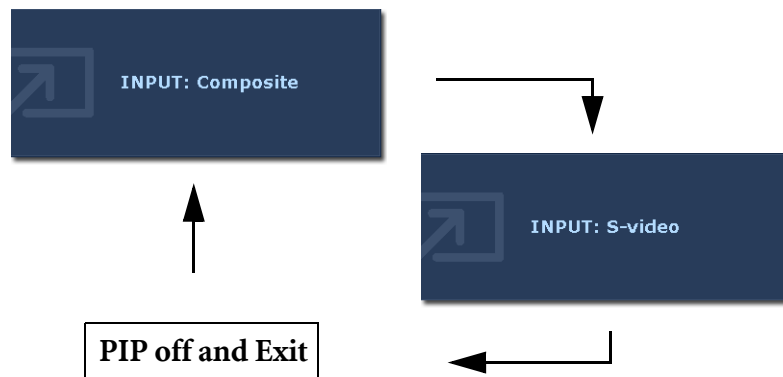

- If the input source of the main window is from the video signals (Composite or S-video), you will cycle through the following messages indicating the computer graphic/PC video signals for the PIP window.

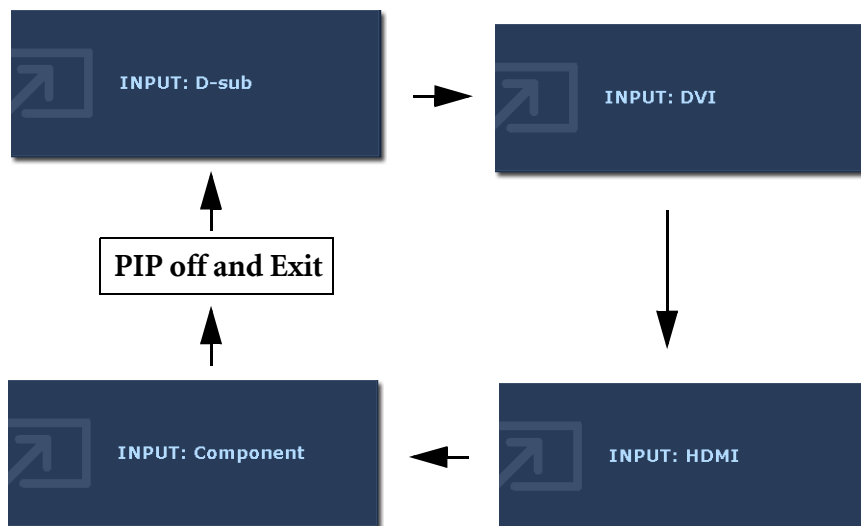

### Mode hot key

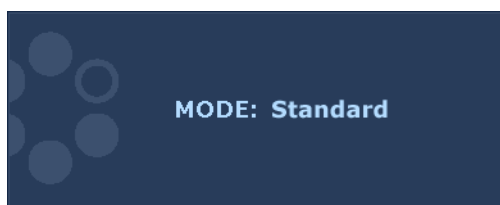

Press the key continually to switch between the 6 modes for the main window, including Standard, Movie, Dynamics, Photo, Action Game, and Racing Game. The setting will take effect immediately.

See also [Picture Mode on page 35](#).

## Game Mode hot key

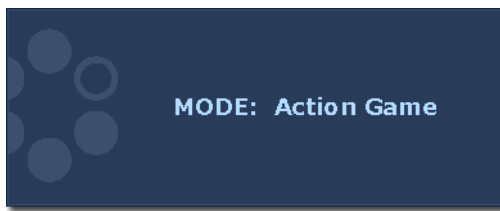

Press the key continually to switch between the 3 modes for the main window, including Standard, Action Game, and Racing Game. The setting will take effect immediately.

See also [Picture Mode on page 35](#).

## Input /Swap hot key



Press the **Input/Swap** key continually to select an input source for the main window or swap the input signals between the main window and the PIP window when the PIP function is activated.

To specify the input source, release the key when you see the message of the preferred input source, which will be lasting for around 3 seconds.

The setting will take effect immediately.

- When the **PIP** function is **OFF**, select between the computer graphic/PC video input sources and video input sources. To specify the input signal, release the key while the message displays.

The input signal messages will be displayed in sequence as below:

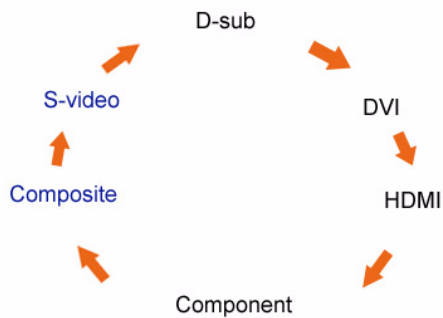

☞ The **Computer Graphic/PC Video** input sources include D-sub, DVI, HDMI, and Component, while the **Video** input sources include Composite and S-video.

- When the **PIP** function is **ON**, select between various input sources of the current video type (Computer Graphic/PC video or Video) for the main window. The cycle will be performed in a specific sequence. Keeping pressing the key will swap the current main window's signal source with the current PIP window's signal source. To specify the input signal, release the key while the message displays.

If the current main window source is from the Computer Graphic/PC video input signals, the input signal messages will be displayed in sequence as below:

D-sub → DVI → HDMI → Component → **SWAP**

If the current main window source is from the Video input signals, the input signal messages will be displayed in sequence as below:

Composite → S-video → **SWAP**

☞ The **PIP** function will not allow for 2 computer graphic/PC video sources or 2 video sources to perform PIP.

💡 To specify an input video source for the PIP window, press **Enter** to make a selection. See also **PIP hot key on page 26**.

### PerfectMotion hot key



Press the **PerfectMotion** key to display the **PerfectMotion** indicator. Further press the **▲** key to increase or the **▼** key to decrease the level of PerfectMotion to the desired value, ranging from 0 to 3, and press the **MENU** key to exit.

See also **PerfectMotion on page 36**.

☞ It is recommended that you use this function specially when you are viewing dynamic contents, such as movies, games, etc.

## Main menu mode

You can use the OSD (On Screen Display) menu to adjust all the settings on your monitor. Press the **MENU** key to display the following main OSD menu.



There are 6 main OSD menus:

1. Display
2. Picture
3. Picture Advanced
4. PIP (Picture in Picture)
5. Audio
6. System

Use the **▲** (Up) or **▼** (Down) keys to highlight a menu item, and press the **ENTER** key to enter the Menu item settings.

 There are 14 different menu languages, see “[Language on page 41](#)” under “OSD Settings” for more details.

For more information on each menu, please refer to the following pages:

- [Display menu on page 31](#)
- [Picture menu on page 33](#)
- [Picture Advanced menu on page 35](#)
- [PIP \(Picture-in-Picture\) menu on page 37](#)
- [Audio menu on page 39](#)
- [System menu on page 40](#)

 The **Audio** menu is only available when the HDMI cable is connected to the monitor and HDMI is set to be the input signal for the main window.

## Display menu



1. Press the **MENU** key to display the main menu.
2. Press the **▲** or **▼** keys to select **DISPLAY** and then press the **ENTER** key to enter the menu.
3. Press the **▲** or **▼** keys to move the highlight to a menu item and then press the **ENTER** key to select that item.
4. Press the **▲** or **▼** keys to make adjustments or selections.
5. To return to the previous menu, press the **MENU** key.

☞ The current picture mode is displayed in the top right corner of the main menu. See [Picture Mode on page 35](#) to learn more information.

Item	Function	Operation	Range
Auto Adjustment	<p>Optimizes and adjusts the screen settings automatically for you. The <i>i</i> key is a 'hot-key' for this function.</p> <p>☞ When you connect a digital video output using a digital (DVI) cable to your monitor, the <i>i</i> key and the <b>Auto Adjustment</b> function will be disabled.</p>	Press the <b>ENTER</b> key to select this option and make adjustment.	

H. Position	Adjusts the horizontal position of the screen image.	Press the ▲ or ▼ keys to adjust the value.	0 to 100
V. Position	Adjusts the vertical position of the screen image.		0 to 100
Pixel Clock	Adjusts the pixel clock frequency timing to synchronize with the analog input video signal. Not applicable to a digital input signal.  See also: <a href="#">Picture optimization on page 22</a>		0 to 100
Phase	Adjusts the pixel clock phase timing to synchronize with the analog input video signal. Not applicable to a digital input signal.  See also: <a href="#">Picture optimization on page 22</a>		0 to 63



## Picture menu



1. Press the **MENU** key to display the main menu.
2. Press the **▲** or **▼** keys to select **PICTURE** and then press the **ENTER** key to enter the menu.
3. Press the **▲** or **▼** keys to move the highlight to a menu item and then press the **ENTER** key to select that item.
4. Press the **▲** or **▼** keys to make adjustments or selections.
5. To return to the previous menu, press the **MENU** key.

Item	Function	Operation	Range
Brightness	Adjusts the balance between light and dark shades.	Press the <b>▲</b> key to increase the brightness and press the <b>▼</b> key to decrease the brightness.	0 to 100
Contrast	Adjusts the degree of difference between darkness and lightness.	Press the <b>▲</b> key to increase the contrast and press the <b>▼</b> key to decrease the contrast.	0 to 100
Sharpness	Adjusts the clarity and visibility of the edges of the subjects in the image.	Press the <b>▲</b> key to improve the crispness of the display and press the <b>▼</b> key to have softness effect on the display.	1 to 5
Color - Press <b>ENTER</b> to enter the <b>Color</b> menu.			
Normal	Allows video and still photographs to be viewed with natural coloring. This is the factory default color.	Press the <b>▲</b> or <b>▼</b> keys to select this option.	
Bluish	Applies a cool tint to the image and is factory pre-set to the PC industry standard white color.		
Reddish	Applies a warm tint to the image and is factory pre-set to the news print standard white color.		

User Mode	Tailors the image color tint. The blend of the Red, Green and Blue primary colors can be altered to change the color tint of the image. The default start setting is 50. Decreasing one or more of the colors will reduce their respective influence on the color tint of the image. e.g. if you reduce the Blue level the image will gradually take on a yellowish tint. If you reduce Green, the image will become a magenta tint.	Press the ▲ or ▼ keys and the <b>ENTER</b> key to select <b>Red, Green, or Blue</b> . Then use the ▲ or ▼ keys to make the color adjustments.	<ul style="list-style-type: none"> <li>• Red (0 to 100)</li> <li>• Green (0 to 100)</li> <li>• Blue (0 to 100)</li> </ul>
Press <b>Menu</b> to leave the menu.			
Reset Color	Resets the <b>User Mode</b> custom color settings to the factory defaults.	Press the ▲ or ▼ keys to change the settings.	<ul style="list-style-type: none"> <li>• YES</li> <li>• NO</li> </ul>
Hue	Adjusts the level of the primary color or mixtures of main colors which present in the displayed image.  ☞ The function is not available for use when the input source is D-Sub or DVI-D.	Press the ▲ or ▼ keys to move the highlight to a menu item and then press the ▲ or ▼ keys to adjust the value.	<ul style="list-style-type: none"> <li>• 0 to 100</li> </ul>
Saturation	Adjusts the purity and intensity of colors in the displayed image.  ☞ The function is not available for use when the input source is D-Sub or DVI-D.		<ul style="list-style-type: none"> <li>• 0 to 100</li> </ul>

## Picture Advanced menu



1. Press the **MENU** key to display the main menu.
2. Press the **▲** or **▼** keys to select **PICTURE ADVANCED** and then press the **ENTER** key to enter the menu.
3. Press the **▲** or **▼** keys to move the highlight to a menu item and then press the **ENTER** key to select that item.
4. Press the **▲** or **▼** keys to make adjustments or selections.
5. To return to the previous menu, press the **MENU** key.

Item	Function	Operation	Range
Picture Mode	<p>Selects a picture mode that best suits the type of images shown on the screen.</p> <ul style="list-style-type: none"> <li>• Standard - for basic PC application.</li> <li>• Movie - for viewing videos.</li> <li>• Dynamics - for viewing landscape-specific videos.</li> <li>• Photo - for viewing still images.</li> <li>• Action Game - for playing action games, at the second level of the PerfectMotion function.</li> <li>• Racing Game - for playing fast paced racing games, at the third level of the PerfectMotion function.</li> </ul>	<p>Press the <b>▲</b> or <b>▼</b> keys to change the settings.</p> <p>☞ When 'Action Game' or 'Racing Game' is set as the picture mode, you cannot turn off 'PerfectMotion' or manually set its value. See also <a href="#">PerfectMotion on page 36</a>.</p>	<ul style="list-style-type: none"> <li>• Standard</li> <li>• Movie</li> <li>• Dynamics</li> <li>• Photo</li> <li>• Action Game</li> <li>• Racing Game</li> </ul>

Senseye Demo	Displays the preview of screen images under the selected mode from <b>Picture Mode</b> . The screen will be divided into two windows; the left window demonstrates images of Standard mode, while the right window presents the images under the specified mode.	Press the ▲ or ▼ keys to change the settings.	<ul style="list-style-type: none"> <li>• ON</li> <li>• OFF</li> </ul>
PerfectMotion	<p>Selects to activate PerfectMotion* to reduce the ghosting effect on the dynamic images.</p> <p>☞ It is recommended that you use this function specially when you are viewing dynamic contents, such as movies, games, etc. Slight flicker on the screen may be noticeable in the case of viewing non-dynamic object. Please make the selection according to your needs.</p>	<p>Press the ▲ or ▼ keys to adjust the value.</p> <p>☞ The higher value, the better the improvement in ghosting effect, yet flicker may also be more noticeable with lower brightness on the image. Choosing the level of 0 will turn 'PerfectMotion' off.</p> <p>☞ When 'Action Game' or 'Racing Game' is set as the picture mode, you cannot turn off 'PerfectMotion' or manually set its value.</p>	0 to 3

\*BenQ's PerfectMotion technology is introduced to well prevent you from ghosting or motion blur effects while viewing fast moving objects on your LCD monitor. The solution to such a problem can be explored from two aspects, one is from the LCD technology itself, and the other is from human visual perception. As the combination of AMA (Advanced Motion Acceleration) technology and BFI (Black Frame Insertion) technology, PerfectMotion is not only in pursuit of achieving faster gray-to-gray response time so the faster pixel transition speed will improve the ghosting effect, but by adopting the use of BFI technology, the visual effect of motion blur resulted from human eye's spatial-temporal integration can also be effectively eliminated, thus clearer motion pictures will be displayed on the monitor. When the PerfectMotion function is activated, the displayed motion pictures will be enhanced by insertion of multiple black frames between frames.

## PIP (Picture-in-Picture) menu



1. Press the **MENU** key to display the main menu.
2. Press the **▲** or **▼** keys to select **PIP** and then press the **ENTER** key to enter the menu.
3. Press the **▲** or **▼** keys to move the highlight to a menu item and then press the **ENTER** key to select that item.
4. Press the **▲** or **▼** keys to make adjustments or selections.
5. To return to the previous menu, press the **MENU** key.

Item	Function	Operation	Range
Input	<p>Selects the video input for PIP viewing window. Use this to change the input to that appropriate to your video cable connection type.</p> <p>See also <a href="#">PIP hot key on page 26</a></p>	<p>Press the <b>▲</b> or <b>▼</b> keys to change the settings.</p> <p>☞ This command can bring up a window from a second image source. Thus you can watch images from 1 computer graphic/PC video source (D-sub, DVI, Component, or HDMI) and 1 video source (Composite, or S-video). The PIP function will not allow for 2 computer graphic/PC video sources or 2 video sources to perform PIP.</p>	<ul style="list-style-type: none"> <li>• Composite</li> <li>• S-video</li> <li>• OFF</li> </ul> <p>or</p> <ul style="list-style-type: none"> <li>• D-sub</li> <li>• DVI</li> <li>• HDMI</li> <li>• Component</li> <li>• OFF</li> </ul>
Size	Adjusts the size of the PIP window.	Press the <b>▲</b> or <b>▼</b> keys to change the settings.	<ul style="list-style-type: none"> <li>• Small</li> <li>• Medium</li> <li>• Large</li> </ul>
H. Position	Adjusts the horizontal position of the PIP window.	Press the <b>▲</b> or <b>▼</b> keys to adjust the value.	0 to 25
V. Position	Adjusts the vertical position of the PIP window.		

Contrast	Adjusts the degree of difference between darkness and lightness of the images in the PIP window.	Press the ▲ key to increase the contrast and press the ▼ key to decrease the contrast.	0 to 100
Sharpness	Adjusts the clarity and visibility of the edges of the subjects in the images displayed in the PIP window.	Press the ▲ key to improve the crispness of the display and press the ▼ key to have softness effect on the display.	1 to 5

## Audio menu

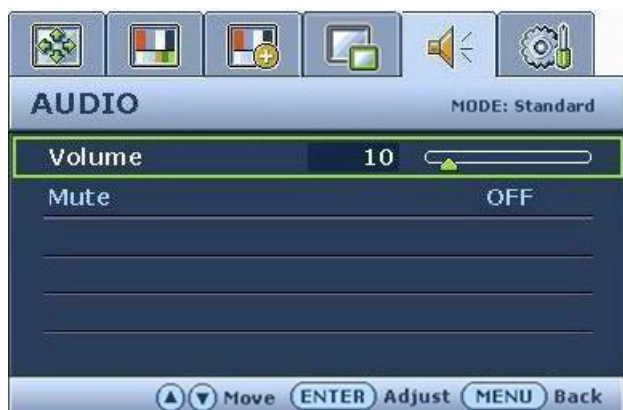

1. Press the **MENU** key to display the main menu.
2. Press the **▲** or **▼** keys to select **AUDIO** and then press the **ENTER** key to enter the menu.
3. Press the **▲** or **▼** keys to move the highlight to a menu item and then press the **ENTER** key to select that item.
4. Press the **▲** or **▼** keys to make adjustments or selections.
5. To return to the previous menu, press the **MENU** key.

☞ The **Audio** menu is only available when the HDMI cable is connected to the monitor and HDMI is set to be the input signal for the main window.

Item	Function	Operation	Range
Volume	Adjusts the level of volume.	Press the <b>▲</b> key to increase the volume and press the <b>▼</b> key to decrease the volume.	0 to 100
Mute	Mutes the audio input.	Press the <b>▲</b> or <b>▼</b> keys to change the settings.	<ul style="list-style-type: none"> <li>• ON</li> <li>• OFF</li> </ul>

## System menu



1. Press the **MENU** key to display the main menu.
2. Press the **▲** or **▼** keys to select **SYSTEM** and then press the **ENTER** key to enter the menu.
3. Press the **▲** or **▼** keys to move the highlight to a menu item and then press the **ENTER** key to select that item.
4. Press the **▲** or **▼** keys to make adjustments or selections.
5. To return to the previous menu, press the **MENU** key.

Item	Function	Operation	Range
Input	<p>Selects the video input for the main window. Use this to change the input to that appropriate to your video cable connection type.</p> <p>See also <a href="#">Input /Swap hot key on page 28</a></p>	Press the <b>▲</b> or <b>▼</b> keys to change the settings.	<ul style="list-style-type: none"> <li>• Composite</li> <li>• S-video</li> <li>• D-sub</li> <li>• DVI</li> <li>• HDMI</li> <li>• Component</li> </ul>



Display Mode	<p>Adjusts the screen image to fit into the size you prefer when the input video images may have different native aspect ratios.</p> <ul style="list-style-type: none"> <li>• Full - Displays the image across the complete width and height of the screen. This mode may cause distortion of the image.</li> <li>• Aspect - Vertically fits the image to the height of the screen and adjusts the width of image to maintain the image proportions.</li> <li>• 1:1- Displays the image based on the native input source resolution in the centre of the screen without alteration.</li> </ul>	<p>Press the ▲ or ▼ keys to change the settings.</p>	<ul style="list-style-type: none"> <li>• Full</li> <li>• Aspect</li> <li>• 1:1</li> </ul>
OSD Settings - Press <b>ENTER</b> to enter the <b>OSD Settings</b> menu.			
Language	<p>Sets the OSD menu language.</p>	<p>Press the ▲ or ▼ keys to adjust the value.</p> <p>☞ The language options displayed on your OSD may differ from those shown on the right, depending on the product supplied in your region.</p>	<ul style="list-style-type: none"> <li>• English</li> <li>• French</li> <li>• German</li> <li>• Italian</li> <li>• Spanish</li> <li>• Polish/ Japanese</li> <li>• Czech/ Traditional Chinese</li> <li>• Hungarian/ Simplified Chinese</li> <li>• Serbo-Croatian</li> <li>• Romanian</li> <li>• Dutch</li> <li>• Russian</li> <li>• Swedish</li> <li>• Portuguese</li> </ul>

H. Position	Adjusts the horizontal position of the OSD menu.	Press the ▲ or ▼ keys to adjust the value.	0 to 100
V. Position	Adjusts the vertical position of the OSD menu.		0 to 100
Display Time	Adjusts the display time of the OSD menu.		<ul style="list-style-type: none"> <li>• 5 sec.</li> <li>• 10 sec.</li> <li>• 15 sec.</li> <li>• 20 sec.</li> <li>• 25 sec.</li> <li>• 30 sec.</li> </ul>
OSD Lock	Prevents all the monitor settings from being accidentally changed. When this function is activated, the OSD controls and hotkey operations will be disabled.	<p>Press the ▲ or ▼ keys to change the settings.</p> <p> To unlock the OSD controls when the OSD is preset to be locked, press and hold the 'ENTER' key for 15 seconds to enter the 'OSD Lock' option and make changes. Alternatively, you may use the ▲ or ▼ keys to select 'OFF' in the 'OSD Lock' submenu under the 'OSD Settings' menu, and all OSD controls will be accessible.</p>	<ul style="list-style-type: none"> <li>• ON</li> <li>• OFF</li> </ul>
Press <b>MENU</b> to leave the <b>OSD Settings</b> menu.			
DDC/CI*	Allows the monitor settings to be set through the software on the PC.	Press the <b>ENTER</b> key to select this option. Press the ▲ or ▼ keys to change the settings.	<ul style="list-style-type: none"> <li>• YES</li> <li>• NO</li> </ul>
Information	Displays the current monitor property settings.	Press the <b>ENTER</b> key to select this option.	
Reset All	Resets all mode, color and geometry settings to the factory default values.	Press the ▲ or ▼ keys to change the settings.	<ul style="list-style-type: none"> <li>• YES</li> <li>• NO</li> </ul>



\*DDC/CI, short for Display Data Channel/Command Interface, which was developed by Video Electronics Standards Association (VESA). DDC/CI capability allows monitor controls to be sent via the software for remote diagnostics.

## 9. Troubleshooting

### Frequently asked questions (FAQ)

② The image is blurred:

☞ Read the [How to adjust the screen resolution on page 20](#) section, and then select the correct resolution, refresh rate and make adjustments based on these instructions.

☞ How do you use a VGA extension cable?

Remove the extension cable for the test. Is the image now in focus? If not, optimize the image by working through the instructions in the [How to adjust the screen refresh rate on page 21](#) section. It is normal for blurring to occur due to conduction losses in extension cables. You can minimize these losses by using an extension cable with better conduction quality or with a built-in booster.

☞ Does the blurring only occur at resolutions lower than the native (maximum) resolution?

Read the [How to adjust the screen resolution on page 20](#) section. Select the native resolution.

② Pixel errors can be seen:

☞ One of several pixels is permanently black, one or more pixels are permanently white, one or more pixels are permanently red, green, blue or another color.

- Clean the LCD screen.
- Cycle power on-off.
- These are pixels that are permanently on or off and is a natural defect that occurs in LCD technology.

② The image has a faulty coloration:

☞ It has a yellow, blue or pink appearance.

Select MENU > PICTURE > Color > Reset Color, and then choose “YES” in the “Caution” message box to reset the color settings to the factory defaults.

If the image is still not correct and the OSD also has faulty coloration, this means one of the three primary colors is missing in the signal input. Now check the signal cable connectors. If any pin is bent or broken off, please contact your dealer to get necessary support.

② No image can be seen:

☞ Is the prompt on the display illuminated in green?

If the LED is illuminated in green and there is a message “Out of Range” on the screen, this means you are using a display mode that this monitor does not support, please change the setting to one of the supported mode. Please read “[Supported PC Timings on page 45](#)” section. Recommended mode is 1920 x 1200 @ 60Hz.

② Faint shadow from the static image displayed is visible on the screen:

- Activate the power management function to let your computer and monitor go into a low power "sleep" mode when not actively in use.
- Use a screensaver to prevent the occurrence of image retention.

② Is the prompt on the display illuminated in orange?

If the LED is illuminated in orange, the power management mode is active. Press any key on the computer keyboard or move the mouse. If that does not help, check the signal cable connectors. If any pin is bent or broken off, please contact your dealer to get necessary support.

☞ Is the prompt on the display not illuminated at all?

Check the power supply mains socket, the external power supply and the mains switch.

② The image is distorted, flashes or flickers:

☞ Read the [How to adjust the screen resolution on page 20](#) section and then select the correct resolution, refresh rate and make adjustments based on these instructions.

② The image is displaced in one direction:

☞ Read the [How to adjust the screen resolution on page 20](#) section and then select the correct resolution, refresh rate and make adjustments based on these instructions.

② The OSD controls are inaccessible:

- To unlock the OSD controls when the OSD is preset to be locked, press and hold the “ENTER” key for 15 seconds to enter the “OSD Lock” option and make changes.
- Alternatively, you may use the ▲ or ▼ keys to select “OFF” in the “OSD Lock” submenu from the “OSD Settings” menu (under SYSTEM), and all OSD controls will be accessible.

## Need more help?

If your problems remain after checking this manual, please contact your place of purchase or e-mail us at: [Support@BenQ.com](mailto:Support@BenQ.com)

## 10. Supported PC Timings

Incoming display mode (Input timing)				
Resolution	Horizontal Frequency (KHz)	Vertical Frequency (Hz)	Pixel Frequency (MHz)	Comment
640 x 350	31.47	70.08	25.17	DOS
720 x 400	31.47	70.08	28.32	DOS
640 x 480	31.47	60.00	25.18	DOS
640 x 480	35.00	67.00	30.24	Macintosh
640 x 480	37.86	72.80	31.50	VESA
640 x 480	37.50	75.00	31.50	VESA
800 x 600	37.88	60.32	40.00	VESA
800 x 600	48.08	72.19	50.00	VESA
800 x 600	46.87	75.00	49.50	VESA
832 x 624	49.72	74.55	57.29	Macintosh
1024 x 768	48.36	60.00	65.00	VESA
1024 x 768	56.48	70.10	75.00	VESA
1024 x 768	60.02	75.00	78.75	VESA
1024 x 768	60.24	74.93	80.00	Macintosh
1152 x 864	67.50	75.00	108.00	VESA
1152 x 870	68.68	75.06	100.00	Macintosh
1152 x 900	61.80	66.00	94.50	SUN 66
1152 x 900	71.81	76.14	108.00	SUN
1280 x 960	60.00	60.00	108.00	VESA
1280 x 1024	64.00	60.00	108.00	VESA
1280 x 1024	75.83	71.53	128.00	IBMI
1280 x 1024	80.00	75.00	135.00	VESA
1280 x 1024	81.18	76.16	135.09	SPARC2
1600 x 1200	75.00	60.00	162.00	VESA
1920 x 1200	75.00	60.00	162.09	VESA

- Image disruption may occur as a result of signal frequency differences from graphic cards which do not correspond with the usual standard. This is not, however, an error. You may improve this situation by altering an automatic setting or by manually changing the phase setting and the pixel frequency from the “Display” menu.
- To extend the service life of the product, we recommend that you use your computer's power management function.

# 11. Specifications

Model	FP241VW
Display type	24.0", active, TFT
Viewable diagonal	611.32 mm
Native (maximum) resolution	1,920 x 1200
Colors	16.7 million
Contrast / Brightness	1000:1 / 500 cd/m <sup>2</sup>
Response time*	16 ms 6 ms (GTG*) 12 ms (MPRT*, PerfectMotion* Level 3)
Viewing angle (left/right, up/down)	178, 178 (CR <sub>≥</sub> 10)
Line frequency	30 - 81 kHz Multi- frequency monitor
Image frequency	56 - 76 Hz modes within these parameters
Image diagnostics	Digital, OSD Technology, <i>i</i> key (automatic image setting)
Controls	9 keys and <i>i</i> key.
Functions	Contrast, brightness, vert. & hor. image position, phase, pixel clock, color balance, color palette, hue, saturation, sharpness, multiple-language OSD, OSD position, OSD lock, input selection, PIP input selection, PIP adjustments, picture mode, Senseye demo, PerfectMotion activation, display mode, DDC/CI*
Power management	VESA DPMS, EPA
Max. power consumption	< 95 Watt (without USB port)
Standby power consumption	< 2 Watt
	 This product comply with ENERGY STAR® Program Requirements Computer Monitors. Version 4.0
Input signals	RGB analog 0.7 Vpp/75 Ohm positive, DVI-D, Composite, Component, S-Video, HDMI
Synchronization	TTL separate signal connection 15-pin mini D-sub cable
Temperature (operating)	0 °C - 40 °C
Air humidity (operating)	10% - 90%
Certifications	TCO 06, TÜV/Ergonomics, TÜV/GS, FCC Class B, ISO 13406-2, VCCI, CB Report, CE, C-Tick, BSMI, Fimko, GOST, CSA, CCC, MIC

Operating voltage	Automatic switched mode power supply, 100-240 V, 50-60 Hz
Tilt (down/up)	-5° ~ +12 °
Dimensions (H x W x D)	471.4 x 700 x 135.6 mm
Weight	10 kg

\*Response Time: The time it takes to switch a pixel off and then on and then off again (or from black to white and back to black). A low response time is desirable for the display of moving images without ghosting. The Response Time quoted for many LCD monitors is specific to transitions from black to white and back again, it does not specify the time required to switch between the many gray levels or colors that make up an image.

\*Gray to Gray or GTG Response Time: "Real world" video content contains a combination of grayscale images. It generally takes longer for a pixel to transition to an intermediate level of intensity (i.e. a gray or color level) than it does for it to turn completely black or completely white. For example the "Gray to Gray response time" of an LCD panel may generally be 30 to 40 ms while the "Response Time" is 12 ms.

\*MPRT: Motion Picture Response Time.

\*BenQ's PerfectMotion technology is introduced to well prevent you from ghosting or motion blur effects while viewing fast moving objects on your LCD monitor. The solution to such a problem can be explored from two aspects, one is from the LCD technology itself, and the other is from human visual perception. As the combination of AMA (Advanced Motion Acceleration) technology and BFI (Black Frame Insertion) technology, PerfectMotion is not only in pursuit of achieving faster gray-to-gray response time so the faster pixel transition speed will improve the ghosting effect, but by adopting the use of BFI technology, the visual effect of motion blur resulted from human eye's spatial-temporal integration can also be effectively eliminated, thus clearer motion pictures will be displayed on the monitor. When the PerfectMotion function is activated, the displayed motion pictures will be enhanced by insertion of multiple black frames between frames.

\*DDC/CI, short for Display Data Channel/Command Interface, which was developed by Video Electronics Standards Association (VESA). DDC/CI capability allows monitor controls to be sent via the software for remote diagnostics.