



HTR-6180

AV Receiver

OWNER'S MANUAL

IMPORTANT SAFETY INSTRUCTIONS

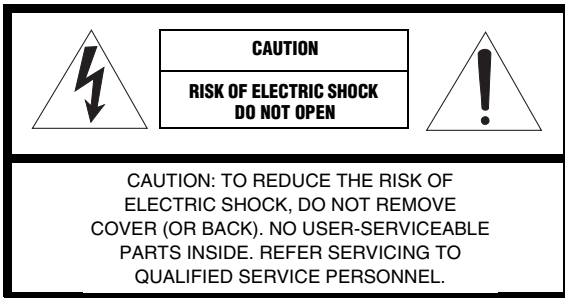

• Explanation of Graphical Symbols

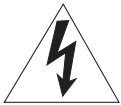

The lightning flash with arrowhead symbol, within an equilateral triangle, is intended to alert you to the presence of uninsulated “dangerous voltage” within the product’s enclosure that may be of sufficient magnitude to constitute a risk of electric shock to persons.



The exclamation point within an equilateral triangle is intended to alert you to the presence of important operating and maintenance (servicing) instructions in the literature accompanying the appliance.

- 1 Read Instructions – All the safety and operating instructions should be read before the product is operated.
- 2 Retain Instructions – The safety and operating instructions should be retained for future reference.
- 3 Heed Warnings – All warnings on the product and in the operating instructions should be adhered to.
- 4 Follow Instructions – All operating and use instructions should be followed.
- 5 Cleaning – Unplug this product from the wall outlet before cleaning. Do not use liquid cleaners or aerosol cleaners.
- 6 Attachments – Do not use attachments not recommended by the product manufacturer as they may cause hazards.
- 7 Water and Moisture – Do not use this product near water – for example, near a bath tub, wash bowl, kitchen sink, or laundry tub; in a wet basement; or near a swimming pool; and the like.
- 8 Accessories – Do not place this product on an unstable cart, stand, tripod, bracket, or table. The product may fall, causing serious injury to a child or adult, and serious damage to the product. Use only with a cart, stand, tripod, bracket, or table recommended by the manufacturer, or sold with the product. Any mounting of the product should follow the manufacturer’s instructions, and should use a mounting accessory recommended by the manufacturer.
- 9 A product and cart combination should be moved with care. Quick stops, excessive force, and uneven surfaces may cause the product and cart combination to overturn.



- 10 Ventilation – Slots and openings in the cabinet are provided for ventilation and to ensure reliable operation of the product and to protect it from overheating, and these openings must not be blocked or covered. The openings should never be blocked by placing the product on a bed, sofa, rug, or other similar surface. This product should not be placed in a built-in installation such as a bookcase or rack unless proper ventilation is provided or the manufacturer’s instructions have been adhered to.
- 11 Power Sources – This product should be operated only from the type of power source indicated on the marking label. If you are not sure of the type of power supply to your home, consult your product dealer or local power company. For products intended to operate from battery power, or other sources, refer to the operating instructions.
- 12 Grounding or Polarization – This product may be equipped with a polarized alternating current line plug (a plug having one blade wider than the other). This plug will fit into the power outlet only one way. This is a safety feature. If you are unable to insert the plug fully into the outlet, try reversing the plug. If the plug should still fail to fit, contact your electrician to replace your obsolete outlet. Do not defeat the safety purpose of the polarized plug.
- 13 Power-Cord Protection – Power-supply cords should be routed so that they are not likely to be walked on or pinched by items placed upon or against them, paying particular attention to cords at plugs, convenience receptacles, and the point where they exit from the product.
- 14 Lightning – For added protection for this product during a lightning storm, or when it is left unattended and unused for long periods of time, unplug it from the wall outlet and disconnect the antenna or cable system. This will prevent damage to the product due to lightning and power-line surges.
- 15 Power Lines – An outside antenna system should not be located in the vicinity of overhead power lines or other electric light or power circuits, or where it can fall into such power lines or circuits. When installing an outside antenna system, extreme care should be taken to keep from touching such power lines or circuits as contact with them might be fatal.
- 16 Overloading – Do not overload wall outlets, extension cords, or integral convenience receptacles as this can result in a risk of fire or electric shock.
- 17 Object and Liquid Entry – Never push objects of any kind into this product through openings as they may touch dangerous voltage points or short-out parts that could result in a fire or electric shock. Never spill liquid of any kind on the product.
- 18 Servicing – Do not attempt to service this product yourself as opening or removing covers may expose you to dangerous voltage or other hazards. Refer all servicing to qualified service personnel.
- 19 Damage Requiring Service – Unplug this product from the wall outlet and refer servicing to qualified service personnel under the following conditions:
 - a) When the power-supply cord or plug is damaged,
 - b) If liquid has been spilled, or objects have fallen into the product,
 - c) If the product has been exposed to rain or water,

- d) If the product does not operate normally by following the operating instructions. Adjust only those controls that are covered by the operating instructions as an improper adjustment of other controls may result in damage and will often require extensive work by a qualified technician to restore the product to its normal operation,
 - e) If the product has been dropped or damaged in any way, and
 - f) When the product exhibits a distinct change in performance - this indicates a need for service.
- 20 Replacement Parts** – When replacement parts are required, be sure the service technician has used replacement parts specified by the manufacturer or have the same characteristics as the original part. Unauthorized substitutions may result in fire, electric shock, or other hazards.
- 21 Safety Check** – Upon completion of any service or repairs to this product, ask the service technician to perform safety checks to determine that the product is in proper operating condition.
- 22 Wall or Ceiling Mounting** – The unit should be mounted to a wall or ceiling only as recommended by the manufacturer.
- 23 Heat** – The product should be situated away from heat sources such as radiators, heat registers, stoves, or other products (including amplifiers) that produce heat.

- 24 Outdoor Antenna Grounding** – If an outside antenna or cable system is connected to the product, be sure the antenna or cable system is grounded so as to provide some protection against voltage surges and built-up static charges. Article 810 of the National Electrical Code, ANSI/NFPA 70, provides information with regard to proper grounding of the mast and supporting structure, grounding of the lead-in wire to an antenna discharge unit, size of grounding conductors, location of antenna discharge unit, connection to grounding electrodes, and requirements for the grounding electrode.

EXAMPLE OF ANTENNA GROUNDING

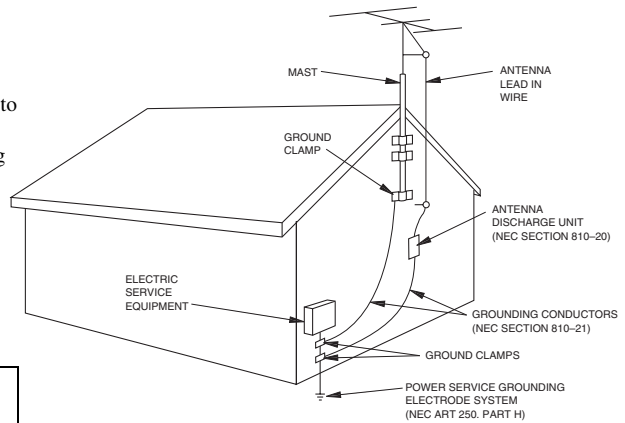

NEC – NATIONAL ELECTRICAL CODE

Note to CATV system installer:

This reminder is provided to call the CATV system installer’s attention to Article 820-40 of the NEC that provides guidelines for proper grounding and, in particular, specifies that the cable ground shall be connected to the grounding system of the building, as close to the point of cable entry as practical.

FCC INFORMATION (for US customers)

1 IMPORTANT NOTICE: DO NOT MODIFY THIS UNIT!

This product, when installed as indicated in the instructions contained in this manual, meets FCC requirements. Modifications not expressly approved by Yamaha may void your authority, granted by the FCC, to use the product.

- 2 IMPORTANT:** When connecting this product to accessories and/or another product use only high quality shielded cables. Cable/s supplied with this product **MUST** be used. Follow all installation instructions. Failure to follow instructions could void your FCC authorization to use this product in the USA.

- 3 NOTE:** This product has been tested and found to comply with the requirements listed in FCC Regulations, Part 15 for Class “B” digital devices. Compliance with these requirements provides a reasonable level of assurance that your use of this product in a residential environment will not result in harmful interference with other electronic devices.

This equipment generates/uses radio frequencies and, if not installed and used according to the instructions found in the users manual, may cause interference harmful to the operation of other electronic devices.

Compliance with FCC regulations does not guarantee that interference will not occur in all installations. If this product is found to be the source of interference, which can be determined by turning the unit “OFF” and “ON”, please try to eliminate the problem by using one of the following measures:

Relocate either this product or the device that is being affected by the interference.

Utilize power outlets that are on different branch (circuit breaker or fuse) circuits or install AC line filter/s.

In the case of radio or TV interference, relocate/reorient the antenna. If the antenna lead-in is 300 ohm ribbon lead, change the lead-in to coaxial type cable.

If these corrective measures do not produce satisfactory results, please contact the local retailer authorized to distribute this type of product. If you can not locate the appropriate retailer, please contact Yamaha Electronics Corp., U.S.A. 6660 Orangethorpe Ave., Buena Park, CA 90620.

The above statements apply **ONLY** to those products distributed by Yamaha Corporation of America or its subsidiaries.

Caution: Read this before operating your unit.

- 1 To assure the finest performance, please read this manual carefully. Keep it in a safe place for future reference.
- 2 Install this sound system in a well ventilated, cool, dry, clean place – away from direct sunlight, heat sources, vibration, dust, moisture, and/or cold. Allow ventilation space of at least 30 cm on the top, 20 cm on the left and right, and 20 cm on the back of this unit.
- 3 Locate this unit away from other electrical appliances, motors, or transformers to avoid humming sounds.
- 4 Do not expose this unit to sudden temperature changes from cold to hot, and do not locate this unit in an environment with high humidity (i.e. a room with a humidifier) to prevent condensation inside this unit, which may cause an electrical shock, fire, damage to this unit, and/or personal injury.
- 5 Avoid installing this unit where foreign objects may fall onto this unit and/or this unit may be exposed to liquid dripping or splashing. On the top of this unit, do not place:
 - other components, as they may cause damage and/or discoloration on the surface of this unit.
 - burning objects (i.e. candles), as they may cause fire, damage to this unit, and/or personal injury.
 - containers with liquid in them, as they may fall and liquid may cause electrical shock to the user and/or damage to this unit.
- 6 Do not cover this unit with a newspaper, tablecloth, curtain, etc. in order not to obstruct heat radiation. If the temperature inside this unit rises, it may cause fire, damage to this unit, and/or personal injury.
- 7 Do not plug in this unit to a wall outlet until all connections are complete.
- 8 Do not operate this unit upside-down. It may overheat, possibly causing damage.
- 9 Do not use force on switches, knobs and/or cords.
- 10 When disconnecting the power cable from the wall outlet, grasp the plug; do not pull the cable.
- 11 Do not clean this unit with chemical solvents; this might damage the finish. Use a clean, dry cloth.
- 12 Only voltage specified on this unit must be used. Using this unit with a higher voltage than specified is dangerous and may cause fire, damage to this unit, and/or personal injury. Yamaha will not be held responsible for any damage resulting from use of this unit with a voltage other than specified.
- 13 To prevent damage by lightning, keep the power cord and outdoor antennas disconnected from a wall outlet or the unit during a lightning storm.
- 14 Do not attempt to modify or fix this unit. Contact qualified Yamaha service personnel when any service is needed. The cabinet should never be opened for any reasons.
- 15 When not planning to use this unit for long periods of time (i.e. vacation), disconnect the AC power plug from the wall outlet.
- 16 Install this unit near the AC outlet and where the AC power plug can be reached easily.
- 17 Be sure to read the “Troubleshooting” section on common operating errors before concluding that this unit is faulty.
- 18 Before moving this unit, press **⓪SYSTEM OFF** to set this unit to the standby mode, and then disconnect the AC power plug from the AC wall outlet.
- 19 The batteries shall not be exposed to excessive heat such as sunshine, fire or like.
- 20 Excessive sound pressure from earphones and headphones can cause hearing loss.

WARNING

TO REDUCE THE RISK OF FIRE OR ELECTRIC SHOCK, DO NOT EXPOSE THIS UNIT TO RAIN OR MOISTURE.

As long as this unit is connected to the AC wall outlet, it is not disconnected from the AC power source even if you turn off this unit by **⓪SYSTEM OFF**. In this state, this unit is designed to consume a very small quantity of power.

FOR CANADIAN CUSTOMERS

To prevent electric shock, match wide blade of plug to wide slot and fully insert.
This Class B digital apparatus complies with Canadian ICES-003.

POUR LES CONSOMMATEURS CANADIENS

Pour éviter les chocs électriques, introduire la lame la plus large de la fiche dans la borne correspondante de la prise et pousser jusqu'au fond.
Cet appareil numérique de la classe B est conforme à la norme NMB-003 du Canada.

IMPORTANT

Please record the serial number of this unit in the space below.

MODEL:

Serial No.:

The serial number is located on the rear of the unit. Retain this Owner's Manual in a safe place for future reference.

Contents

INTRODUCTION

| | |
|--------------------------------|---|
| Features | 2 |
| Supplied accessories | 2 |
| Notice | 3 |
| Getting started | 4 |
| Quick start guide | 5 |

PREPARATION

| | |
|--|----|
| Connections | 10 |
| Optimizing the speaker setting for your listening room (YPAO) | 32 |
| Using AUTO SETUP | 32 |

BASIC OPERATION

| | |
|---|----|
| Selecting the SCENE templates | 37 |
| Selecting the desired SCENE template to the SCENE buttons..... | 37 |
| Creating your original SCENE templates..... | 40 |
| Using the remote control for the SCENE feature..... | 41 |
| Playback | 42 |
| Basic procedure | 42 |
| Selecting the MULTI CH INPUT component..... | 43 |
| Selecting the front speaker set..... | 43 |
| Selecting audio input jacks (AUDIO SELECT)..... | 44 |
| Displaying the current status of this unit on a video monitor | 44 |
| Using your headphones..... | 45 |
| Muting the audio output..... | 45 |
| Playing video sources in the background of an audio source..... | 45 |
| Displaying the input source information | 46 |
| Using the sleep timer | 47 |
| Sound field programs | 48 |
| Selecting sound field programs | 48 |
| Sound field program descriptions..... | 48 |
| Enjoying unprocessed input sources (Straight decoding mode) | 51 |
| Using audio features | 52 |
| Adjusting the speaker level..... | 52 |
| Enjoying pure hi-fi sound | 52 |
| Adjusting the tonal quality..... | 52 |
| FM/AM tuning | 53 |
| Overview..... | 53 |
| Basic tuning operations..... | 53 |
| Using station preset feature | 54 |
| Using HD Radio™ features (U.S.A. model only) | 57 |
| Selecting HD Radio™ audio programs | 57 |
| Displaying HD Radio™ information..... | 58 |
| XM Satellite Radio tuning | 59 |
| Connecting the XM Mini-Tuner Dock | 59 |
| Activating XM Satellite Radio | 60 |
| Basic XM Satellite Radio operations..... | 60 |
| Setting the XM Satellite Radio preset channels | 62 |
| Displaying the XM Satellite Radio information | 63 |

| | |
|---|----|
| SIRIUS Satellite Radio™ tuning | 64 |
| Connecting the SiriusConnect™ tuner | 64 |
| Activating SIRIUS Satellite Radio™ subscription..... | 65 |
| Basic SIRIUS Satellite Radio™ operations | 65 |
| Setting the SIRIUS Satellite Radio™ preset channels | 67 |
| Setting the Parental Lock..... | 67 |
| Displaying the SIRIUS Satellite Radio™ information | 69 |
| Using iPod™ | 70 |
| Controlling iPod™..... | 70 |
| Using Bluetooth™ components | 72 |
| Pairing the Bluetooth™ adapter and your Bluetooth component | 72 |
| Playback of the Bluetooth™ component | 72 |
| Recording | 73 |

ADVANCED OPERATION

| | |
|--|-----|
| Advanced sound configurations | 74 |
| Changing sound field parameter settings..... | 74 |
| Selecting decoders | 79 |
| Customizing this unit (MANUAL SETUP) | 82 |
| Using SET MENU | 86 |
| 1 BASIC MENU | 87 |
| 2 VOLUME MENU | 91 |
| 3 SOUND MENU | 92 |
| 4 INPUT MENU | 95 |
| 5 OPTION MENU | 98 |
| Remote control features | 102 |
| Controlling this unit, a TV, or other components | 102 |
| Setting remote control codes | 104 |
| Resetting all remote control codes..... | 105 |
| Using multi-zone configuration | 106 |
| Connecting Zone 2..... | 106 |
| Controlling Zone 2..... | 107 |
| Advanced setup | 109 |
| Using the advanced setup | 109 |

ADDITIONAL INFORMATION

| | |
|--|-----|
| Troubleshooting | 113 |
| Resetting the system | 122 |
| Glossary | 123 |
| Sound field program information | 126 |
| Specifications | 127 |
| Index | 129 |

APPENDIX

(at the end of this manual)

| | |
|---|-----|
| Front panel | i |
| Remote control | ii |
| List of remote control codes | iii |

“(A) SPEAKERS” or “(4) DVD” (example) indicates the name of the parts on the front panel or the remote control. Refer to the attached sheet or the pages at the end of this manual for the information about each position of the parts.

INTRODUCTION

PREPARATION

BASIC OPERATION

ADVANCED OPERATION

ADDITIONAL INFORMATION

APPENDIX

English

Features

Built-in 7-channel power amplifier

- ◆ Minimum RMS output power (1 kHz, 0.7% THD, 8 Ω)
Front: 120 W + 120 W
Center: 120 W
Surround: 120 W + 120 W
Surround back: 120 W + 120 W

SCENE function

- ◆ Preset SCENE templates for various situations
- ◆ SCENE templates for customizing capability
- ◆ Controlling Yamaha SCENE control signal support component (some models only) working with the SCENE function

Sound field programs

- ◆ Proprietary Yamaha technology for the creation of sound fields
- ◆ Compressed Music Enhancer mode
- ◆ Virtual CINEMA DSP
- ◆ SILENT CINEMA

Digital audio decoders

- ◆ Dolby TrueHD, Dolby Digital Plus decoder
- ◆ DTS-HD Master Audio, DTS-HD High Resolution Audio decoder
- ◆ Dolby Digital/Dolby Digital EX decoder
- ◆ DTS/DTS-ES Matrix 6.1, Discrete 6.1, DTS 96/24 decoder
- ◆ Dolby Pro Logic/Dolby Pro Logic II/Dolby Pro Logic IIX decoder
- ◆ Neural Surround decoder
- ◆ SRS CS II decoder (U.S.A. model only)

Radio tuners

- ◆ FM/AM tuning capability
- ◆ HD Radio™ digital broadcast reception capability (U.S.A. model only)
- ◆ XM Satellite Radio tuning capability (using XM Mini-Tuner and Home Dock, sold separately)
- ◆ SIRIUS Satellite Radio™ tuning capability (using SiriusConnect tuner, sold separately)

HDMI™ (High-Definition Multimedia Interface)

- ◆ HDMI interface for standard, enhanced or high-definition video as well as multi-channel digital audio based on HDMI version 1.3a (HDMI is licensed by HDMI Licensing, LLC.)
 - Automatic audio and video synchronization (lip sync) information capability
 - Deep Color video signal (30/36 bit) transmission capability
 - “x.v.Color” video signal transmission capability
 - High refresh rate and high resolution video signals capability
 - High definition digital audio format signals capability
- ◆ HDCP (High-bandwidth Digital Content Protection System) licensed by Digital Content Protection, LLC.
- ◆ Analog video to HDMI digital video up-conversion (composite video ↔ S-video ↔ component video → HDMI digital video) capability for monitor out
- ◆ Analog video up-scaling from 480i (NTSC)/576i (PAL) or 480p/576p to 720p, 1080i or 1080p

DOCK terminal

- ◆ DOCK terminal to connect a Yamaha iPod universal dock (such as YDS-10, sold separately) or Bluetooth adapter (such as YBA-10, sold separately)

Other features

- ◆ YPAO (Yamaha Parametric Room Acoustic Optimizer) for automatic speaker setup
- ◆ 192-kHz/24-bit D/A converter
- ◆ OSD (on-screen display) menus that allow you to optimize this unit to suit your individual audiovisual system
- ◆ 5.1 or 7.1-channel additional input jacks for discrete multi-channel input
- ◆ Component video input/output capability includes (3 COMPONENT VIDEO INs and 1 MONITOR OUT)
- ◆ Digital video signal conversion (composite video ↔ S-video ↔ component video) capability for monitor out
- ◆ Pure Direct mode for pure hi-fi sound for all sources
- ◆ Adaptive dynamic range controlling capability
- ◆ Adaptive DSP effect level controlling capability
- ◆ iPod controlling capability
- ◆ Remote control with preset remote control codes capability
- ◆ Zone 2 custom installation facility
- ◆ Bi-amplification connection capability
- ◆ Sleep timer



Supplied accessories

Check that you received all of the following parts.

- | | |
|---|--|
| <input type="checkbox"/> Remote control | <input type="checkbox"/> AM loop antenna |
| <input type="checkbox"/> Batteries (2) (AA, R6, UM-3) | <input type="checkbox"/> Indoor FM antenna |
| <input type="checkbox"/> Optimizer microphone | |

Notice

About this manual

-  indicates a tip for your operation.
- Some operations can be performed by using either the buttons on the front panel or the ones on the remote control. In case the button names differ between the front panel and the remote control, the button name on the remote control is given in parentheses.
- This manual is printed prior to production. Design and specifications are subject to change in part as a result of improvements, etc. In case of differences between the manual and product, the product has priority.
- “**Ⓐ**SPEAKERS” or “**④**DVD” (example) indicates the name of the parts on the front panel or the remote control. Refer to the attached sheet or the pages at the end of this manual for the information about each position of the parts.
- The symbol “” with page number(s) indicates the corresponding reference page(s).

We Want You Listening For A Lifetime



Yamaha and the Electronic Industries Association's Consumer Electronics Group want you to get the most out of your equipment by playing it at a safe level. One that lets the sound come through loud and clear without annoying blaring or distortion – and, most importantly, without affecting your sensitive

hearing. Since hearing damage from loud sounds is often undetectable until it is too late, Yamaha and the Electronic Industries Association's Consumer Electronics Group recommend you to avoid prolonged exposure from excessive volume levels.



Manufactured under license from Dolby Laboratories. “Dolby”, “Pro Logic”, and the double-D symbol are trademarks of Dolby Laboratories.



Manufactured under license under U.S. Patent No's: 5,451,942;5,956,674;5,974,380;5,978,762;6,226,616;6,487,535 & other U.S. and worldwide patents issued & pending. DTS is a registered trademark and the DTS logos, Symbol, DTS-HD and DTS-HD Master Audio are trademark of DTS, Inc. © 1996-2007 DTS, Inc. All Rights Reserved.

iPod™

“iPod” is a trademark of Apple Inc., registered in the U.S. and other countries.

Bluetooth™

Bluetooth is a registered trademark of the Bluetooth SIG and is used by Yamaha in accordance with a license agreement.

HDMI

“HDMI”, the “HDMI” logo and “High-Definition Multimedia Interface” are trademarks or registered trademarks of HDMI Licensing LLC.

x.v.Color™

“x.v.Color” is a trademark of Sony Corporation.

SILENT™ CINEMA

“SILENT CINEMA” is a trademark of Yamaha Corporation.



The XM name and related logos are registered trademarks of XM Satellite Radio Inc.



Neural Surround™ name and related logos are trademarks owned by Neural Audio Corporation.



©2006 SIRIUS Satellite Radio Inc. “SIRIUS”, “SiriusConnect”, the SIRIUS dog logo, channel names and logos are trademarks of SIRIUS Satellite Radio Inc.

HD Radio

HD Radio™ Technology Manufactured Under License From iBiquity Digital Corp. U.S. and Foreign Patents. HD Radio™ and the HD Radio logo are proprietary trademarks of iBiquity Digital Corp.



Circle Surround II, Dialog Clarity, TruBass, SRS and the  symbol are trademarks of SRS Labs, Inc.

Circle Surround II, Dialog Clarity and TruBass technologies are incorporated under license from SRS Labs, Inc.

Getting started

■ Installing batteries in the remote control

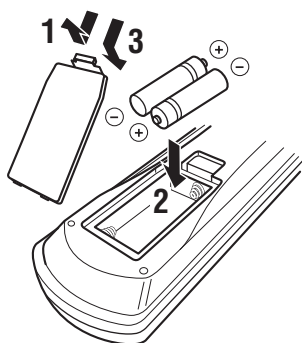

- 1 Take off the battery compartment cover.**
- 2 Insert the two supplied batteries (AA, R6, UM-3) according to the polarity markings (+ and -) on the inside of the battery compartment.**
- 3 Snap the battery compartment cover back into place.**

Notes

- Change all of the batteries if you notice the following conditions:
 - the operation range of the remote control decreases.
 - the **TRANSMIT** indicator does not flash or its light becomes dim.
- Do not use an old battery together with a new one.
- Do not use different types of batteries (such as alkaline and manganese batteries) together. Read the packaging carefully as these different types of batteries may have the same shape and color.
- If the batteries have leaked, dispose of them immediately. Avoid touching the leaked material or letting it come into contact with clothing, etc. Clean the battery compartment thoroughly before installing new batteries.
- Do not throw away batteries with general house waste; dispose of them correctly in accordance with your local regulations.
- If the remote control is without batteries for more than 2 minutes, or if exhausted batteries remain in the remote control, the contents of the memory may be cleared. When the memory is cleared, insert new batteries, set up the remote control code and program any acquired functions that may have been cleared.

Quick start guide

The following steps describe the easiest way to enjoy DVD movie playback in your home theater. See pages 11 to 15 for details of the speaker placement.

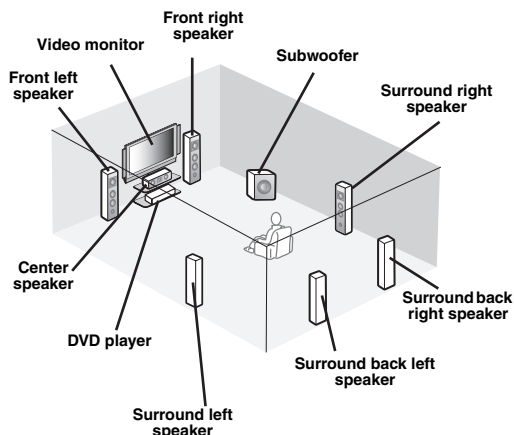

Step 1: Set up your speakers

P. 6

Step 2: Connect your DVD player and other components

P. 7

Step 3: Press SCENE 1 button

P. 8

Enjoy DVD playback!

Preparation: Check the items

Prepare the following items.

- Speakers**
 - Front speakers** x 2
 - Center speaker** x 1
 - Surround speakers** x 4Select magnetically shielded speakers. The minimum required speakers are two front speakers. The priority of the requirement of other speakers is as follows:
 1. Two surround speakers
 2. Center speaker
 3. One (or two) surround back speaker(s)
- Active subwoofer** x 1
Select an active subwoofer equipped with an RCA input jack.
- Speaker cables** x 7
- Subwoofer cable** x 1
Select a monaural RCA cable.
- DVD player** x 1
Select DVD player equipped with coaxial digital audio output jack and composite video output jack.
- Video monitor** x 1
Select a TV monitor, video monitor or projector equipped with a composite video input jack.
- Video cable** x 2
Select an RCA composite video cable.
- Digital coaxial audio cable** x 1



You can also connect two subwoofers to this unit. In this case, prepare two active subwoofers and subwoofer cables.

Step 1: Set up your speakers

Place your speakers in the room and connect them to this unit.

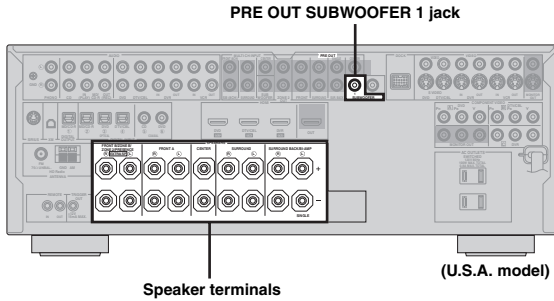

1 Place your speakers and subwoofer in the room.

2 Connect speaker cables to each speaker.

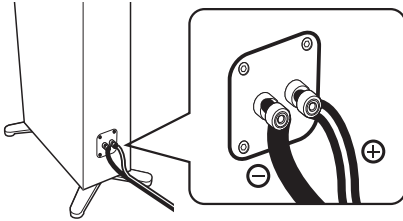

Be sure to connect the “+” (red) and “-” (black) properly. Cables are colored or shaped differently, perhaps with a stripe, groove or ridge. Connect the striped (grooved, etc.) cable to the “+” (red) terminals of this unit and your speaker. Connect the plain cable to the “-” (black) terminals.

3 Connect each speaker cable to the corresponding speaker terminal of this unit.

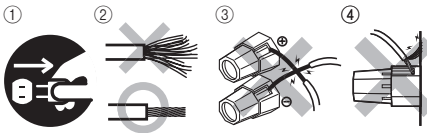

- ① Make sure that this unit and the subwoofer are unplugged from the AC wall outlets.
- ② Twist the exposed wires of the speaker cables together to prevent short circuits.
- ③ Do not let the bare speaker wires touch each other.
- ④ Do not let the bare speaker wires touch any metal part of this unit.

Be sure to connect the left channel (L), right channel (R), “+” (red) and “-” (black) properly.

Front speakers and center speaker

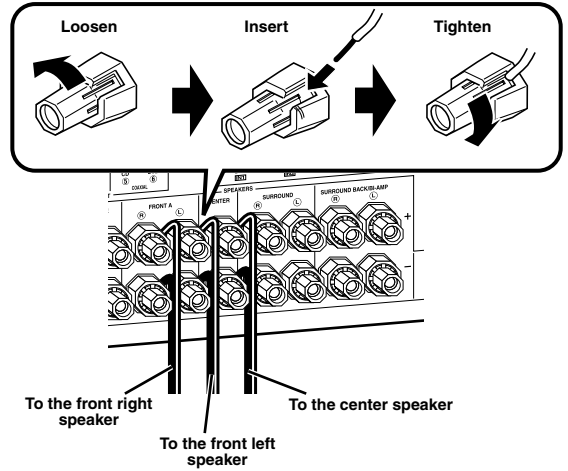

Surround and surround back speakers

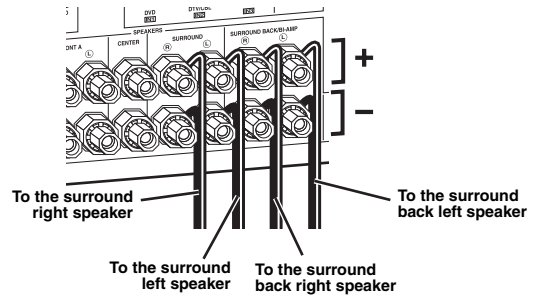

4 Connect the subwoofer cable to the SUBWOOFER PRE OUT 1 jack of this unit and the input jack of the subwoofer.

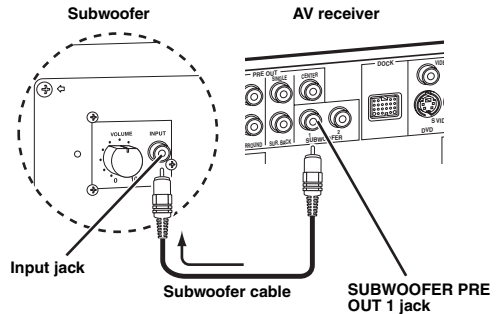

You can also connect another subwoofer to the SUBWOOFER PRE OUT 2 jack.

Step 2: Connect your DVD player and other components

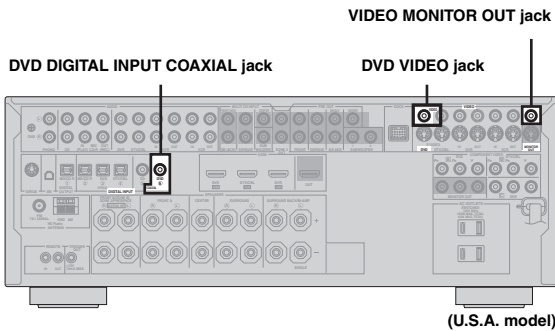

Make sure that this unit and the DVD player are unplugged from the AC wall outlets.

- 1 Connect the digital coaxial audio cable to the digital coaxial audio output jack of your DVD player and the DVD DIGITAL INPUT COAXIAL jack of this unit.

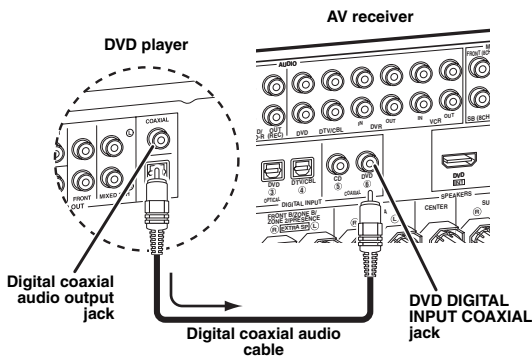

- 2 Connect the video cable to the composite video output jack of your DVD player and DVD VIDEO jack of this unit.

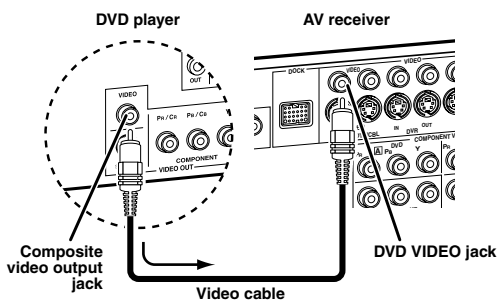

- 3 Connect the video cable to the VIDEO MONITOR OUT jack of this unit and the video input jack of your video monitor.

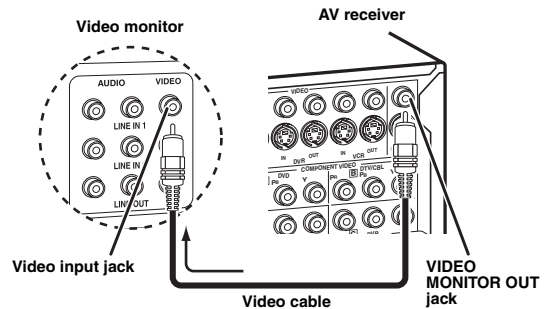

- 4 Connect the power plug of this unit and other components into the AC wall outlet.



This unit is equipped with AC OUTLETS for the power supply of the other components. See page 28 for details.

■ For further connections

- Using the other kind of speaker combinations P. 11
- Connecting a video monitor via various ways of the connection P. 20
- Connecting a DVD player via various ways of the connection P. 21
- Connecting a DVD recorder or a digital video recorder P. 22
- Connecting a set-top box P. 22
- Connecting a CD player, an MD recorder or a turntable P. 23
- Connecting an external amplifier P. 24
- Connecting a DVD player via analog multi-channel audio connection P. 25
- Connecting a Yamaha iPod universal dock or Bluetooth adapter P. 25
- Using the REMOTE IN/OUT jacks P. 26
- Using the VIDEO AUX jacks on the front panel P. 26
- Connecting a FM/AM antenna P. 27
- Connecting the XM Mini-Tuner Dock P. 59
- Connecting the SiriusConnect tuner P. 64

Step 3: Press SCENE 1 button

Check the type of the connected speakers.

If the speakers are 6 ohm speakers, set “SP IMP.” to “6Ω MIN” before using this unit (see page 28). 4 ohm speakers can be also used as the front speakers (see page 109).

1 Turn on the video monitor and then set the input source selector of the video monitor to this unit.

2 Press  SCENE1 button.

This unit is turned on. “DVD Viewing” appears in the front panel display, and this unit automatically optimize own status for the DVD playback.

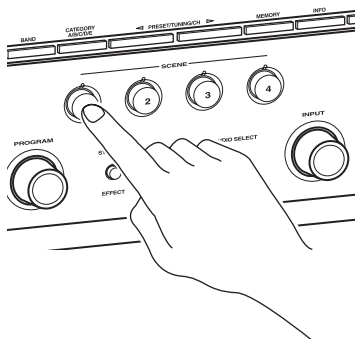

The indicator on the selected SCENE button lights up while this unit is in the SCENE mode.

3 Start playback of the desired DVD on your player.

4 Rotate  VOLUME to adjust the volume.

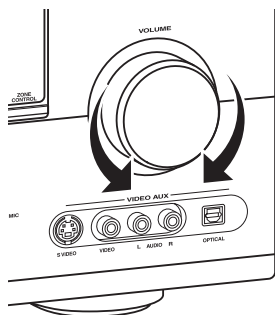

Note

When you change the input source or sound field program, the SCENE mode is deactivated.

About SCENE function

Just by pressing one SCENE button, you can turn on this unit and recall your favorite input source and sound field program according to the SCENE template that has been assigned to the SCENE button. The SCENE templates are built combinations of input sources and sound field programs.



If you connect a Yamaha product that has capability of the SCENE control signals, this unit can automatically activate the component and start playback. Refer to the instruction manual of the DVD player for further information.

The default assigned SCENE templates

| Default SCENE button | The name of the SCENE template and its description |
|----------------------|---|
| SCENE 1 | DVD Viewing – input source: DVD – sound field program: Straight For when you want to listen to a music disc from the connected DVD player as the background music for this room. |
| SCENE 2 | Disc Listening – input source: DVD – sound field program: 7ch Stereo For when you want to listen to a music disc from the connected DVD player as the background music for this room. |
| SCENE 3 | TV Viewing *1 – input source: DTV/CBL – sound field program: Straight For when you want to watch a TV program. |
| SCENE 4 | Radio Listening *2, *3, *4 – input source: TUNER – sound field program: 7ch Enhancer For when you want to listen to a music program from the FM radio station. |

Notes

- *1 You must connect a cable TV or a satellite tuner to this unit in advance. See page 22 for details.
- *2 You need to connect the supplied FM and AM antennas to this unit in advance. See page 27 for details.
- *3 You must tune into the desired radio station in advance. See pages 53 to 56 for tuning information.
- *4 To achieve the best possible reception, orient the connected AM loop antenna, or adjust the position of the end of the indoor FM antenna.



You can change the assigned SCENE template for the SCENE buttons. See page 37 for details.

■ After using this unit...

Press **Ⓚ MAIN ZONE ON/OFF** to set this unit to the standby mode.



This unit is set to the standby mode and consumes a small amount of power in order to receive infrared signals from the remote control. To turn on this unit from the standby mode, press the desired **Ⓢ SCENE** buttons (or **Ⓜ SCENE**) or **Ⓚ MAIN ZONE ON/OFF** (or **Ⓛ POWER**). See page 29 for details.

What do you want to do with this unit?

■ Customizing the SCENE templates

- Using various SCENE templates ☞ P. 37
- Creating your original SCENE templates ☞ P. 40

■ Using various input sources

- Basic controls of this unit ☞ P. 42
- Enjoying FM/AM radio programs ☞ P. 53
- Enjoying XM Satellite Radio programs ☞ P. 59
- Enjoying SIRIUS Satellite Radio programs ☞ P. 64
- Using your iPod with this unit ☞ P. 70
- Using the Bluetooth components ☞ P. 72

■ Using various sound features

- Using various sound field programs ☞ P. 48
- Using the pure direct mode for high fidelity sound ☞ P. 52
- Customizing the sound field programs ☞ P. 74

■ Adjusting the parameters of this unit

- Automatically optimizing the speaker parameters for your listening room (AUTO SETUP) ☞ P. 32
- Manually adjusting various parameters of this unit ☞ P. 82
- Setting the remote control ☞ P. 102
- Adjusting the advanced parameters ☞ P. 109

■ Additional feature

- Automatically turning off this unit ☞ P. 47

Connections

Rear panel

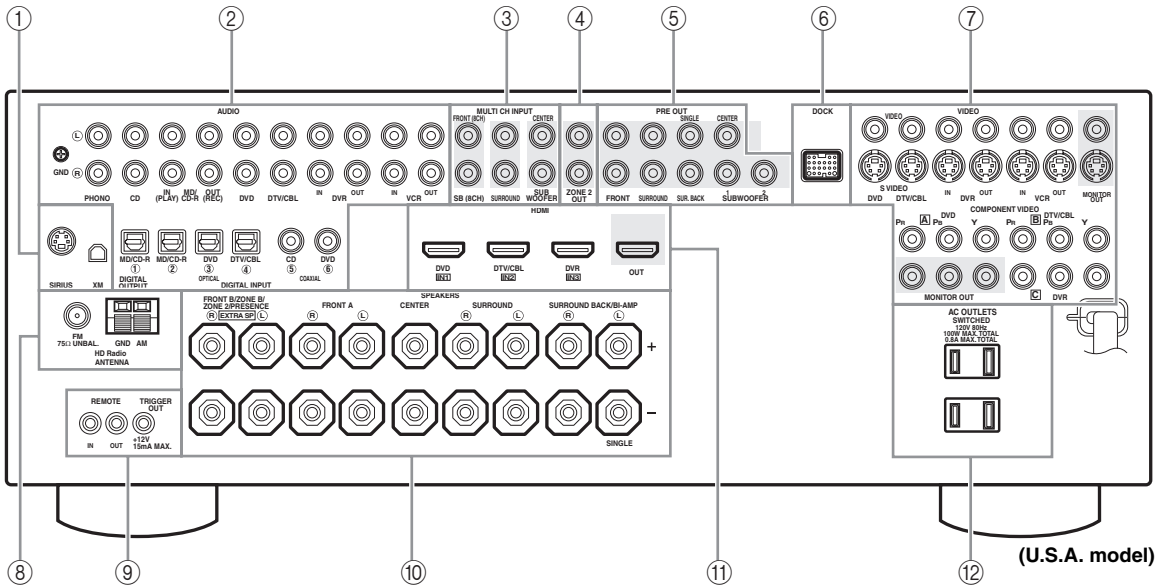

(U.S.A. model)

⑨ TRIGGER OUT jack

This is control expansion jack for custom installation.

| Name | Page |
|---|----------------|
| ① XM jack (U.S.A. and Canada models only) | 59 |
| SIRIUS jack (U.S.A. and Canada models only) | 64 |
| ② AUDIO jacks DIGITAL INPUT/OUTPUT jacks | 21 17-23 |
| ③ MULTI CH INPUT jacks | 25 |
| ④ ZONE2 OUT jacks | 106 |
| ⑤ PRE OUT jacks | 24 |
| ⑥ DOCK terminal | 25 |
| ⑦ Video component jacks (VIDEO and S VIDEO) COMPONENT VIDEO jacks | 17-22 17-22 |
| ⑧ ANTENNA terminals | 27 |
| ⑨ REMOTE IN/OUT jacks | 26 |
| ⑩ Speaker terminals | 11-16 |
| ⑪ HDMI jacks | 18 |
| ⑫ AC OUTLETS | 28 |

Placing speakers

The speaker layout below shows the speaker setting we recommend. You can use it to enjoy the CINEMA DSP and multi-channel audio sources.

7.1-channel speaker layout

7.1-channel speaker layout is highly recommended for playback the sound of high definition audio formats (Dolby TrueHD, DTS-HD Master Audio, etc.) as well as the conventional audio sources with sound field programs. See page 14 for connection information.



We recommend that you also add the presence speakers for the effect sounds of the CINEMA DSP sound field program. See page 13 for details.

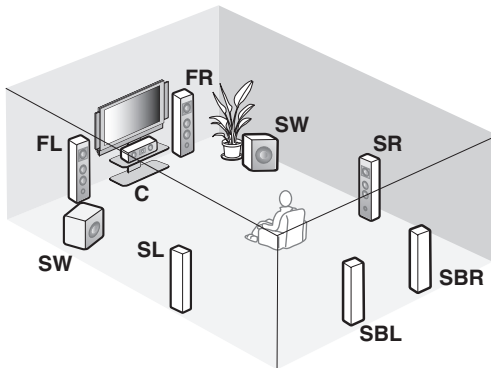

Speaker indications

FL/FR: Front left/right

C: Center

SL/SR: Surround left/right

SBL/SBR: Surround back left/right

SW: Subwoofer

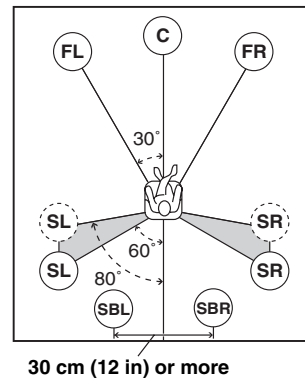

30 cm (12 in) or more

Front left and right speakers

The front speakers are used for the main source sound plus effect sounds. Place these speakers at an equal distance from the ideal listening position. The distance of each speaker from each side of the video monitor should be the same.

Center speaker

The center speaker is for the center channel sounds (dialog, vocals, etc.). If for some reason it is not practical to use a center speaker, you can do without it. Best results, however, are obtained with the full system.

Surround left and right speakers

The surround speakers are used for effect and surround sounds.

Surround back left and right speakers

The surround back speakers supplement the surround speakers and provide more realistic front-to-back transitions.

Subwoofer(s)

The use of a subwoofer with a built-in amplifier, such as the Yamaha Active Servo Processing Subwoofer System, is effective not only for reinforcing bass frequencies from any or all channels, but also for reproducing the high fidelity sound of the LFE (low-frequency effect) channel included in Dolby Digital and DTS sources. You can connect one or two subwoofer(s) to this unit. When you use two subwoofers, you can enjoy deeper bass sound. The position of the subwoofer is not so critical, because low bass sounds are not highly directional. But it is better to place the subwoofer near the front speakers. Turn it slightly toward the center of the room to reduce wall reflections.



When you use two subwoofers, select the same type of the subwoofer as another and set these subwoofers as same sound characteristics. Place each subwoofer at the same distance from the listening position. The signal output at the SUBWOOFER PRE OUT 2 jack is the same as the one output at the SUBWOOFER PRE OUT 1 jack.

6.1-channel speaker layout

See page 14 for connection information.



We recommend that you also add the presence speakers for the effect sounds of the CINEMA DSP sound field program. See page 13 for details.

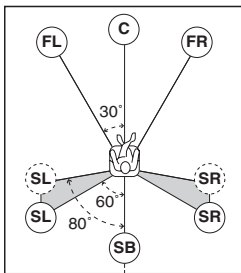
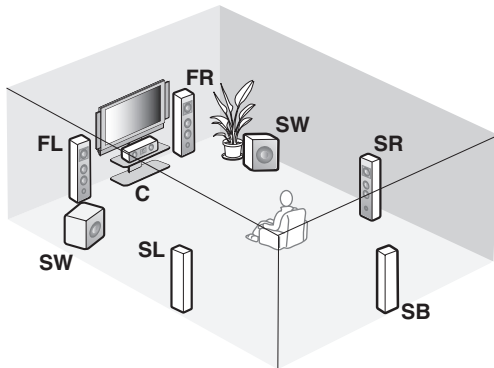

Speaker indications

- FL/FR:** Front left/right
- C:** Center
- SL/SR:** Surround left/right
- SB:** Surround back
- SW:** Subwoofer

- Front left and right speakers**
- Center speaker**
- Surround left and right speakers**
- Subwoofer(s)**

The functions and settings of each speaker are the same as those for the 7.1-channel speaker layout (see page 11).

Surround back speaker

Connect a single surround speakers to the SURROUND BACK SINGLE speaker terminal and place the single surround back speaker behind the listening position. The surround back left and right channel signals are mixed down and output at the single surround back speaker when you set "SUR.B L/R SP" to "SMLx1" or "LRGx1" (see page 88).

5.1-channel speaker layout

See page 14 for connection information.



We recommend that you also add the presence speakers for the effect sounds of the CINEMA DSP sound field program. See page 13 for details.

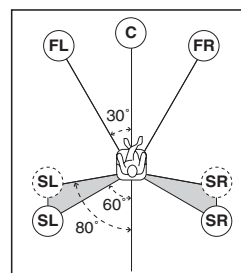
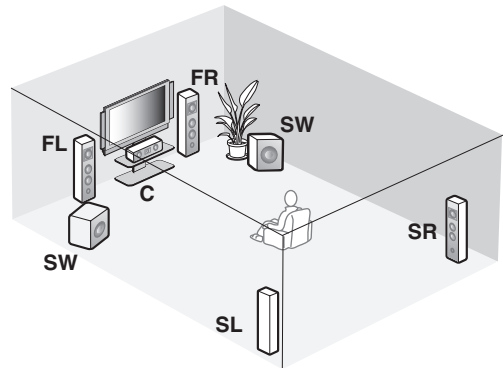

Speaker indications

- FL/FR:** Front left/right
- C:** Center
- SL/SR:** Surround left/right
- SW:** Subwoofer

- Front left and right speakers**
- Center speaker**
- Subwoofer(s)**

The functions and settings of each speaker are the same as those for the 7.1-channel speaker layout (see page 11).

Surround left and right speakers

Connect the surround speakers to the SURROUND speaker terminals even if you place the surround speakers behind the listening position. For the smooth and unbroken sound field behind the listening position, place the surround left and right speakers farther back compared with the placement in the 7.1-channel speaker layout. The surround back channel signals are directed to the surround left and right speakers when "SUR.B L/R SP" is set to "NONE" (see page 88).

For other speaker combinations

You can enjoy multi-channel sources with sound field programs by using a speaker combination other than the 7.1/6.1/5.1-channel speaker combinations.

Use the automatic setup feature (see page 32) or set the "SPEAKER SET" parameters in "MANUAL SETUP" (see page 87) to output the surround sounds at the connected speakers.

■ Using presence speakers

The presence speakers supplement the sound from the front and surround back speakers with extra ambient effects produced by the sound field programs (see page 48). You can adjust the vertical position of dialogues with using the presence speakers (see page 75).

To use the presence speakers, connect the speakers to the EXTRA SP terminal (see page 14) and set “EXTRA SP ASSIGN” to “PRESENCE” (see pages 33 and 87).

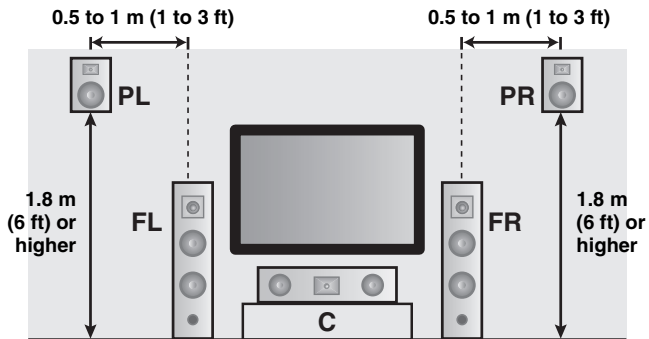

Speaker indications

- FL:** Front left
- FR:** Front right
- C:** Center
- PL:** Front presence left
- PR:** Front presence right

Connecting speakers

Be sure to connect the left channel (L), right channel (R), “+” (red) and “-” (black) properly. If the connections are faulty, this unit cannot reproduce the input sources accurately.

Caution

- Before connecting the speakers, make sure that the AC power plug is disconnected from the AC wall outlet.
- Do not let the bare speaker wires touch each other or let them touch any metal part of this unit. This could damage this unit and/or the speakers. If the speaker wires are short-circuited, “CHECK SP WIRES” appears in the front panel display when you turn on this unit.
- Use the magnetically shielded speakers. If this type of speaker still creates interference with the monitor, place the speakers away from the monitor.
- If you are to use 6 ohm speakers, be sure to set “SP IMP.” to “6Ω MIN” before using this unit (see page 28). 4 ohm speakers can be also used as the front speakers. For details about the speaker impedance setting, see page 109.

Note

A speaker cord is actually a pair of insulated cables running side by side. Cables are colored or shaped differently, perhaps with a stripe, groove or ridge. Connect the striped (grooved, etc.) cable to the “+” (red) terminals of this unit and your speaker. Connect the plain cable to the “-” (black) terminals.

■ For the 7.1-channel speaker setting

EXTRA SP terminals

Connect the alternative front speaker system (FRONT B), front speaker systems in another room (ZONE B), presence speakers, or Zone 2 speakers. To select the function of the speakers connected to the EXTRA SP terminals, set the “EXTRA SP ASSIGN” parameter in “SOUND MENU” (see page 87).



You can also select the function of the speakers connected to the EXTRA SP terminals in “AUTO SETUP” (see page 33).

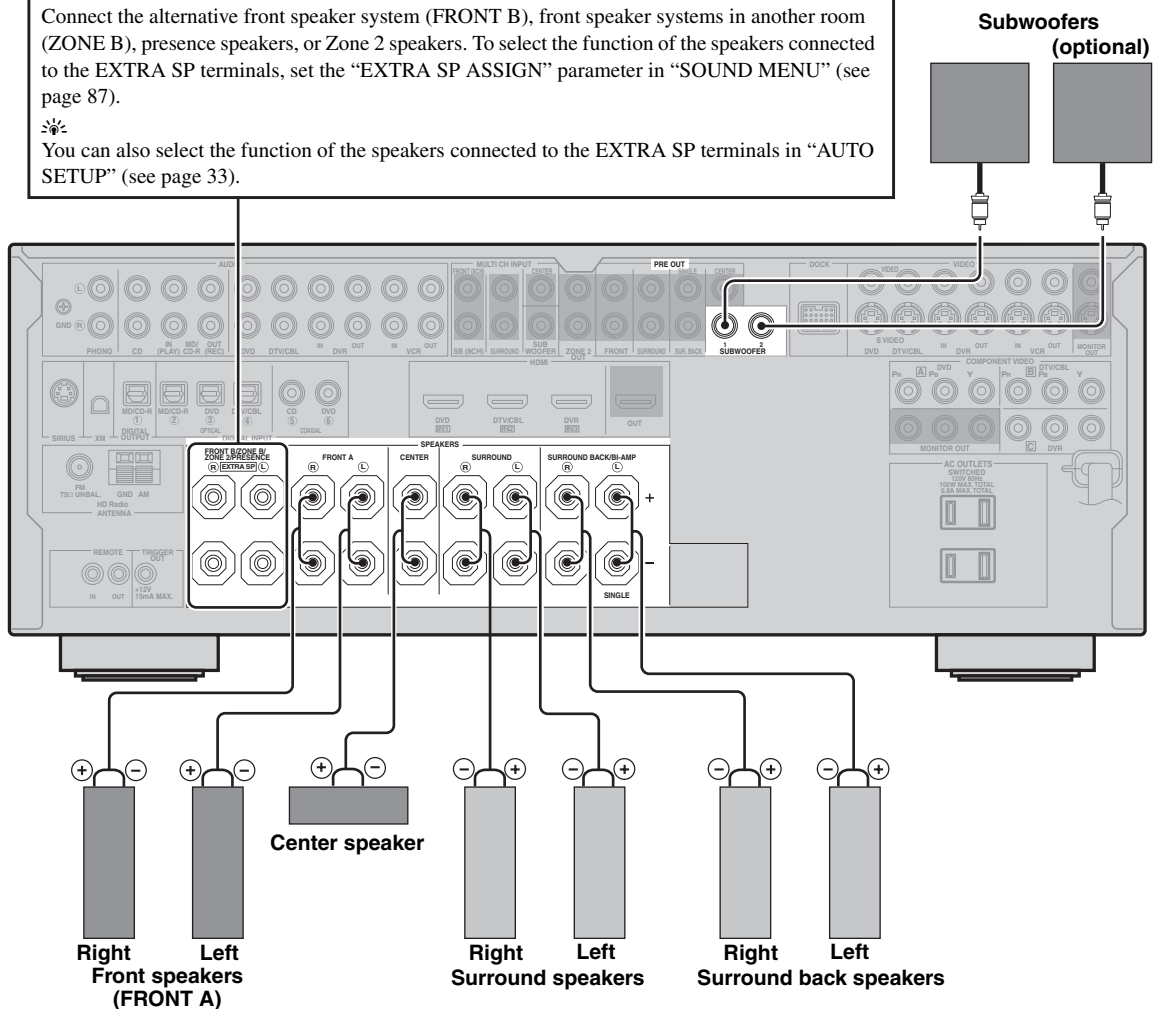

■ For the 6.1-channel speaker setting

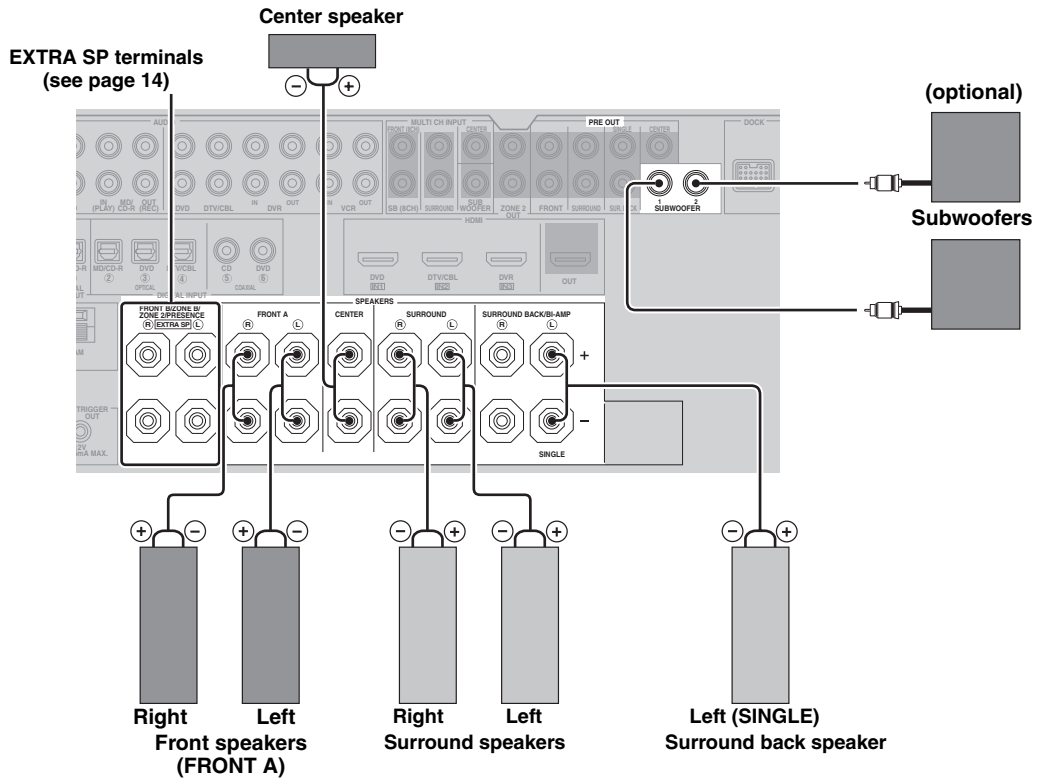

■ For the 5.1-channel speaker setting

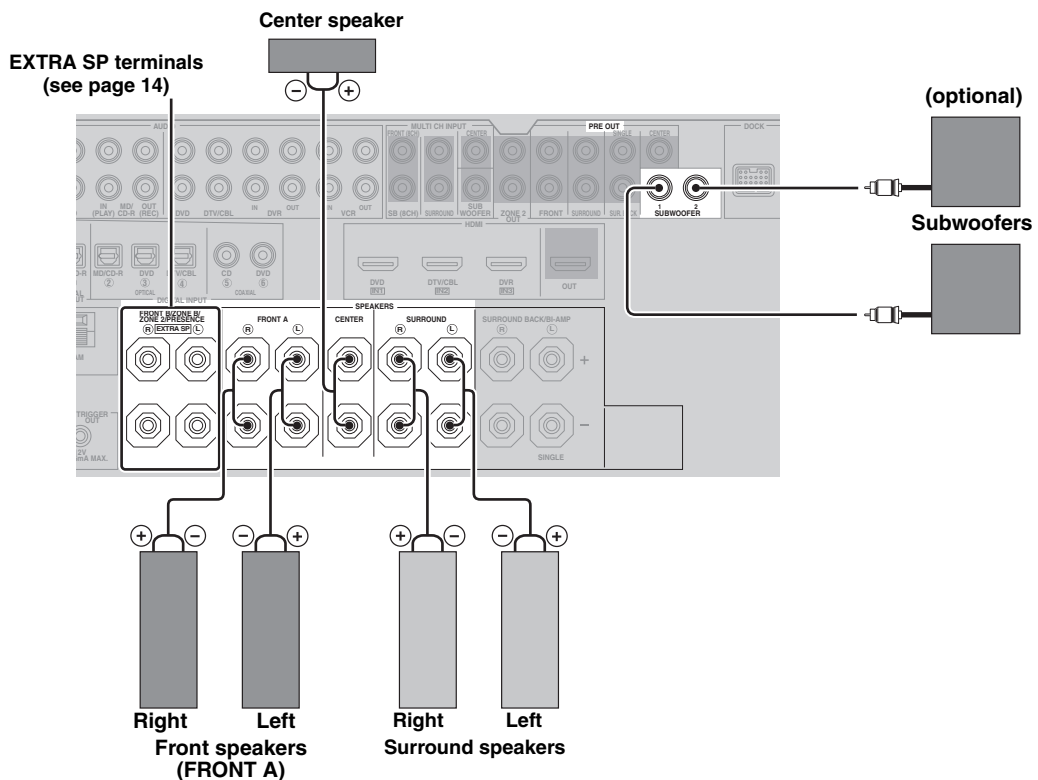

■ Connecting the speaker cable

- 1 Remove approximately 10 mm (0.4 in) of insulation from the end of each speaker cable and then twist the exposed wires of the cable together to prevent short circuits.

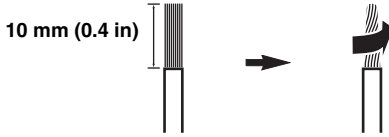

- 2 Loosen the knob.

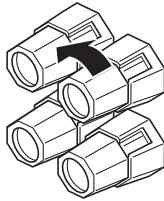

Red: positive (+)
Black: negative (-)

- 3 Insert one bare wire into the hole on the side of each terminal.

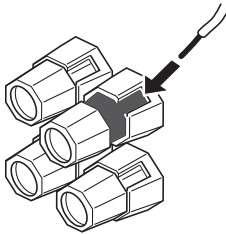

- 4 Tighten the knob to secure the wire.

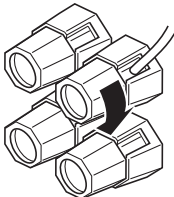

■ Connecting the banana plug (U.S.A. and Canada models only)

Tighten the knob and then insert the banana plug connector into the end of the corresponding terminal.

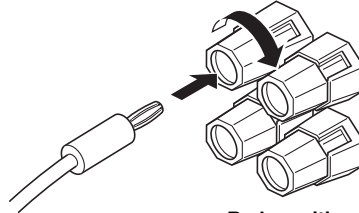

Red: positive (+)
Black: negative (-)

■ Using bi-amplification connections

Caution

Remove the shorting bars or bridges of your speakers to separate the LPF (low pass filter) and HPF (high pass filter) crossovers.

This unit allows you to make bi-amplification connections to one speaker system. Check if your speakers support bi-amplification.

To make the bi-amplification connections, use the FRONT and SURROUND BACK/BI-AMP terminals as shown below. To activate the bi-amplification connections, set "BI-AMP" to "ON" in "ADVANCED SETUP" (see page 112).

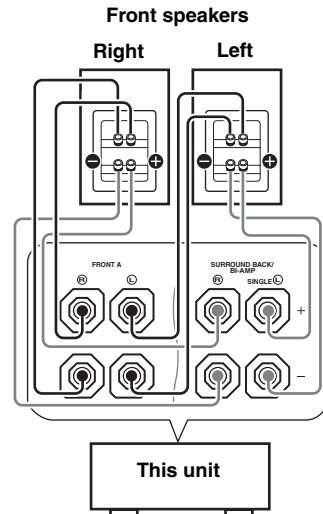

Note

When you make the conventional connection, make sure that the shorting bars are put into the terminals appropriately. Refer to the instruction manuals of the speakers for details.

Information on jacks and cable plugs

Connect one of the type of the audio jack(s) and/or video jack(s) that your input components are equipped with.

Audio jacks and cable plugs

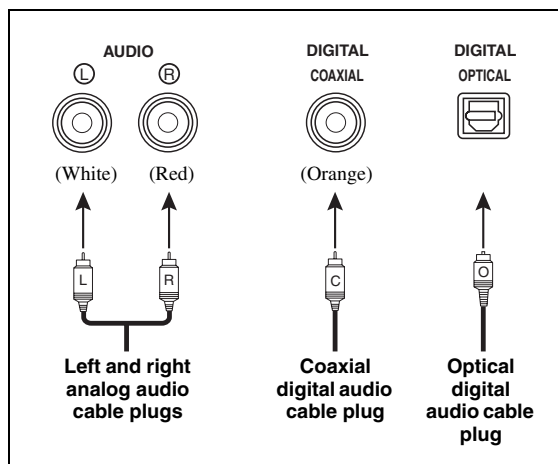

■ Audio jacks

This unit has three types of audio jacks. Connection depends on the availability of audio jacks on your other components.

AUDIO jacks

For conventional analog audio signals transmitted via left and right analog audio cables. Connect red plugs to the right jacks and white plugs to the left jacks.

DIGITAL COAXIAL jacks

For digital audio signals transmitted via coaxial digital audio cables.

DIGITAL OPTICAL jacks

For digital audio signals transmitted via optical digital audio cables.

Note

You can use the digital jacks to input PCM, Dolby Digital and DTS bitstreams. When you connect components to both the COAXIAL and OPTICAL jacks, priority is given to the signals input at the COAXIAL jack. Optical input jacks are compatible with digital signals with up to 96 kHz of sampling frequency.

Video jacks and cable plugs

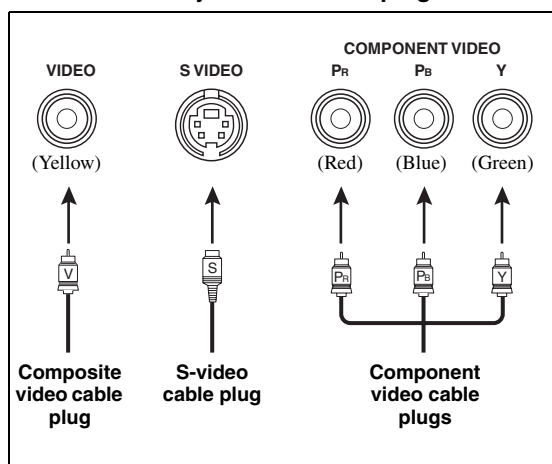

■ Video jacks

This unit has three types of video jacks. Connection depends on the availability of input jacks on your video monitor.

VIDEO jacks

For conventional composite video signals transmitted via composite video cables.

S VIDEO jacks

For S-video signals, separated into the luminance (Y) and chrominance (C) video signals transmitted on separate wires of S-video cables.

COMPONENT VIDEO jacks

For component video signals, separated into the luminance (Y) and chrominance (P_B, P_R) video signals transmitted on separate wires of component video cables.



This unit is equipped with the video conversion function. See pages 19 and 98 for details.

Information on HDMI™

■ HDMI signal compatibility

Audio signals

| Audio signal types | Audio signal formats | Compatible media |
|-----------------------------------|--|---------------------------------------|
| 2ch Linear PCM | 2ch, 32-192 kHz, 16/20/24 bit | CD, DVD-Video, DVD-Audio, etc. |
| Multi-ch Linear PCM | 8ch, 32-192 kHz, 16/20/24 bit | DVD-Audio, Blu-ray Disc, HD DVD, etc. |
| DSD | 2/5.1ch, 2.8224 MHz, 1 bit | SA-CD, etc. |
| Bitstream | Dolby Digital, DTS | DVD-Video, etc. |
| Bitstream (High definition audio) | Dolby TrueHD, Dolby Digital Plus, DTS-HD Master Audio, DTS-HD High Resolution Audio, DTS Express | Blu-ray Disc, HD DVD, etc. |



- If the input source component can decode the bitstream audio signals of audio commentaries, you can play back the audio sources with the audio commentaries mixed down by using the following connections:
 - multi-channel analog audio input (see page 25)
 - DIGITAL INPUT OPTICAL (or COAXIAL)
- Refer to the supplied instruction manuals of the input source component, and set the component appropriately.

Notes

- When CPPM copy-protected DVD-Audio is played back, video and audio signals may not be output depending on the type of the DVD player.
- This unit is not compatible with HDCP-incompatible HDMI or DVI components.
- To decode audio bitstream signals on this unit, set the input source component appropriately so that the component outputs the bitstream audio signals directly (does not decode the bitstream signals on the component). Refer to the supplied instruction manuals for details.
- This unit is not compatible with the audio commentary features (for example, the special audio contents downloaded via Internet) of Blu-ray Disc or HD DVD. This unit does not play back the audio commentaries of the Blu-ray Disc or HD DVD contents.

Video signals

This unit is compatible with the video signals of the following resolutions:

Video signal format

- 480i/60 Hz
- 576i/50 Hz
- 480p/60 Hz
- 576p/50 Hz
- 720p/60 Hz, 50 Hz
- 1080i/60 Hz, 50 Hz
- 1080p/60 Hz, 50 Hz, 24 Hz

Default input assignment of HDMI input jacks

| HDMI input jack | Assigned input source |
|-----------------|-----------------------|
| IN1 | DVD |
| IN2 | DTV/CBL |
| IN3 | DVR |

■ HDMI jack and cable plug

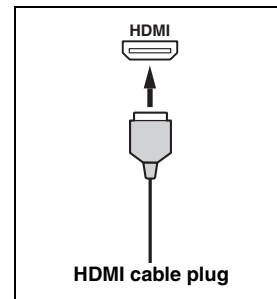

- We recommend that you use an HDMI cable shorter than 5 meters (16 feet) with the HDMI logo printed on it.
- Use a conversion cable (HDMI jack ↔ DVI-D jack) to connect this unit to other DVI components.

Notes

- Do not disconnect or connect the cable or turn off the power of the HDMI components connected to the HDMI OUT jack of this unit while data is being transferred. Doing so may disrupt playback or cause noise.
- If you turn off the power of the video monitor connected to the HDMI OUT jack via a DVI connection, this unit may fail to establish the connection to the component.
- The analog video signals input at the composite video, S-video and component video jacks can be digitally up-converted to be output at the HDMI OUT jack. Set “VIDEO CONV.” to “ON” in “MANUAL SETUP” (see page 98) to activate this feature.

Audio and video signal flow

Audio signal flow

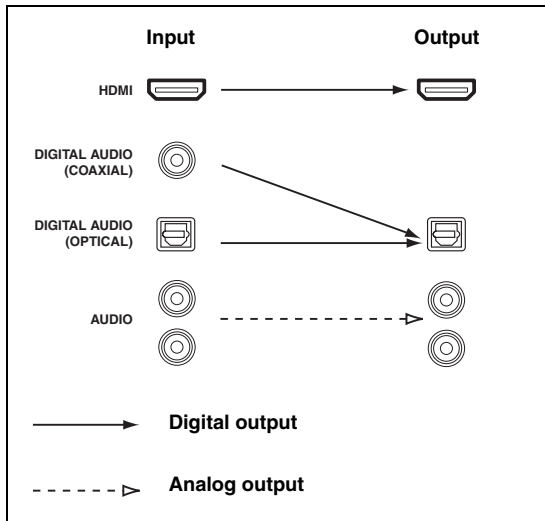

Notes

- 2-channel as well as multi-channel PCM, Dolby Digital and DTS signals input at one of the HDMI IN jacks can be output at the HDMI OUT jack only when "S.AUDIO" is set to "OTHER" (see page 101).
- Audio signals input at the HDMI IN jacks are not output at the AUDIO output and DIGITAL OUTPUT jacks.

Video signal flow

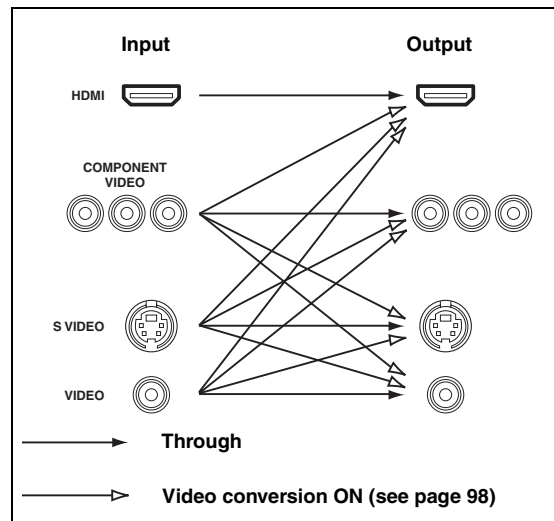

Notes

- When the video signals are input at the HDMI, COMPONENT VIDEO, S VIDEO, and VIDEO jacks, the priority order of the input signals is as follows:
 1. HDMI
 2. COMPONENT VIDEO
 3. S VIDEO
 4. VIDEO
- Digital video signals input at one of the HDMI IN jacks cannot be output from analog video output jacks.
- The analog component video signals with 480i (NTSC)/576i (PAL) of resolution are converted to the S-video or composite video signals and output at the S VIDEO MONITOR OUT and VIDEO MONITOR OUT jacks.
- The analog component video signals with 1080p of resolution are only output at the COMPONENT VIDEO MONITOR OUT jacks.
- Use the "HDMI RES." parameter in "VIDEO SET" to deinterlace and convert the resolution of the analog video signals output at the HDMI OUT jack (see page 99).

Connecting a TV monitor or projector

Connect your TV (or projector) to the HDMI OUT jack, the COMPONENT VIDEO MONITOR OUT jacks, the S VIDEO MONITOR OUT jack or the VIDEO MONITOR OUT jack of this unit.



Make sure that this unit and other components are unplugged from the AC wall outlets.



- You can choose to play back HDMI audio signals on this unit or on another HDMI component connected to the HDMI OUT jack of this unit. Use the “S.AUDIO” parameter in “OPTION MENU” to select the component to play back HDMI audio signals (see page 101).

- When you use the internal tuner of the TV as the input source, connect the digital or analog audio output jacks of the TV and digital or analog audio input jacks of this unit. Refer to “Connecting a set-top box” on page 22 for connecting information.

Notes

- If a video monitor is connected to this unit via a DVI connection, you may not take full advantage of the HDMI features.
- Some video monitors connected to this unit via a DVI connection fail to recognize the HDMI audio/video signals being input if they are in the standby mode. In this case, the HDMI indicator flashes irregularly.
- If the connected video monitor is compatible with the automatic audio and video synchronization feature (automatic lip sync feature), this unit adjusts the audio and video timing automatically (see page 94). Connect the video monitor to the HDMI OUT jack of this unit to use the feature.

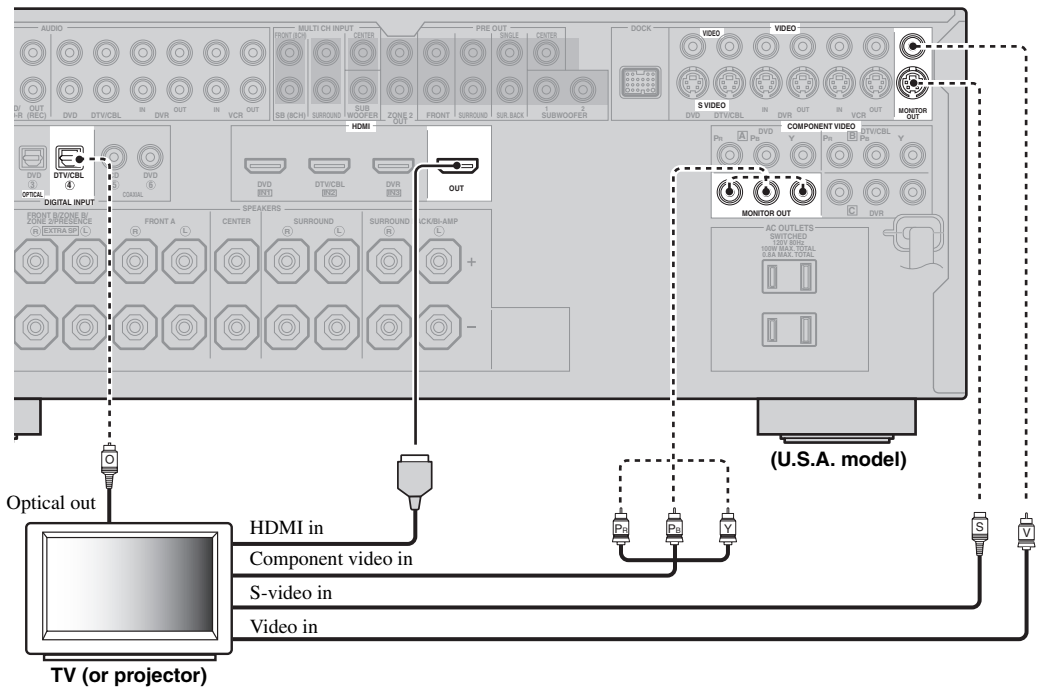

———— indicates recommended connections
 - - - - - indicates alternative connections
 (One for the video connection, and one for the audio connection)

Connecting other components



Make sure that this unit and other components are unplugged from the AC wall outlets.

Notes

- When “VIDEO CONV.” is set to “OFF” (see page 98), be sure to make the same type of video connections as those made for your TV (see page 20). For example, if you connected your TV to the VIDEO MONITOR OUT jack of this unit, connect your other components to the VIDEO jacks.

■ Connecting a DVD player

- When “VIDEO CONV.” is set to “ON” (see page 98), the converted video signals are output only at the MONITOR OUT jacks. To record a source, make the same type of video connections between each component.
- To make a digital connection to a component other than the default component assigned to each DIGITAL INPUT or DIGITAL OUTPUT jack, select the corresponding setting for “OPTICAL OUT”, “OPTICAL IN”, or “COAXIAL IN” in “I/O ASSIGNMENT” (see page 95).
- If you connect your DVD player to both the DIGITAL INPUT (OPTICAL) and the DIGITAL INPUT (COAXIAL) jacks, priority is given to the signals input at the DIGITAL INPUT (COAXIAL) jack.

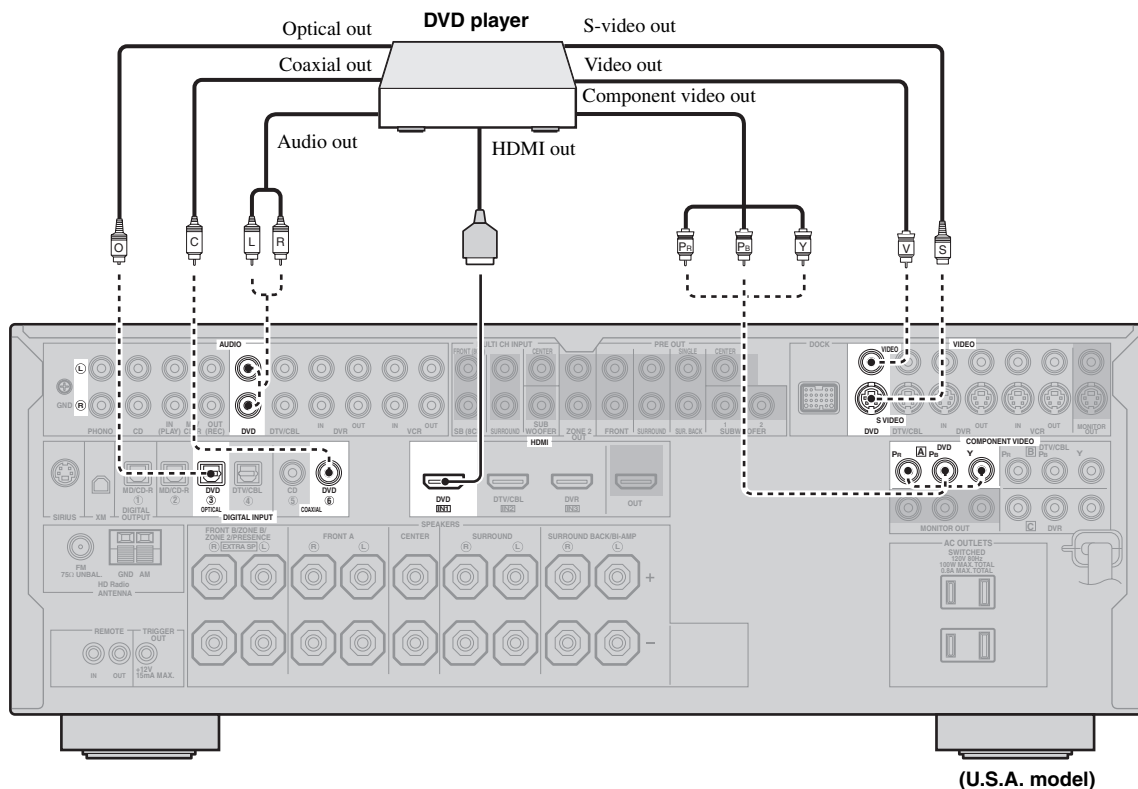

———— indicates recommended connections
 - - - - - indicates alternative connections
 (One for the video connection, and one for the audio connection)

PREPARATION

English

■ Connecting a DVD recorder, PVR or VCR

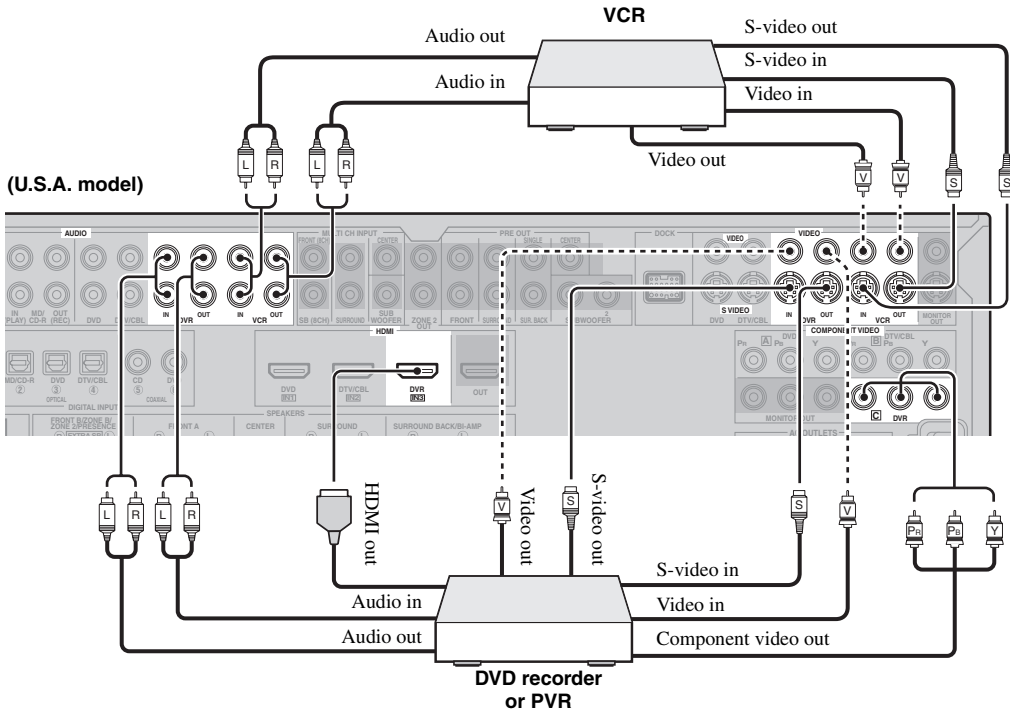

■ Connecting a set-top box

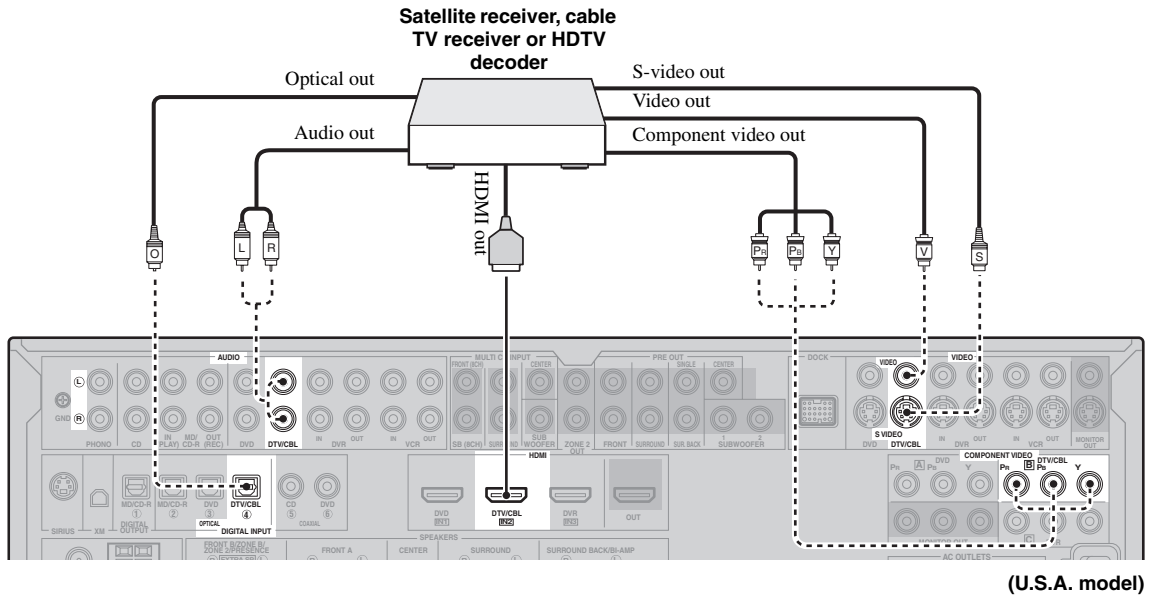

———— indicates recommended connections

- - - - - indicates alternative connections (One for the video connection, and one for the audio connection)

■ Connecting audio components

Notes

- To make a digital connection to a component other than the default component assigned to each the DIGITAL INPUT jack or the DIGITAL OUTPUT jack, select the corresponding setting for “OPTICAL OUT”, “OPTICAL IN”, or “COAXIAL IN” in “I/O ASSIGNMENT” (see page 95).
- Connect your turntable to the GND terminal of this unit to reduce noise in the signal. However, you may hear less noise without the connection to the GND terminal for some turntables.
- The PHONO jacks are only compatible with a turntable with an MM or a high-output MC cartridge. To connect a turntable with a low-output MC cartridge to the PHONO jacks, use an in-line boosting transformer or an MC-head amplifier.
- When you connect both the DIGITAL INPUT (OPTICAL) jack and the DIGITAL INPUT (COAXIAL) jack to an audio component, the priority is given to the DIGITAL INPUT (COAXIAL) jack.

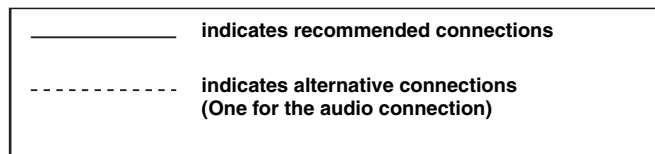
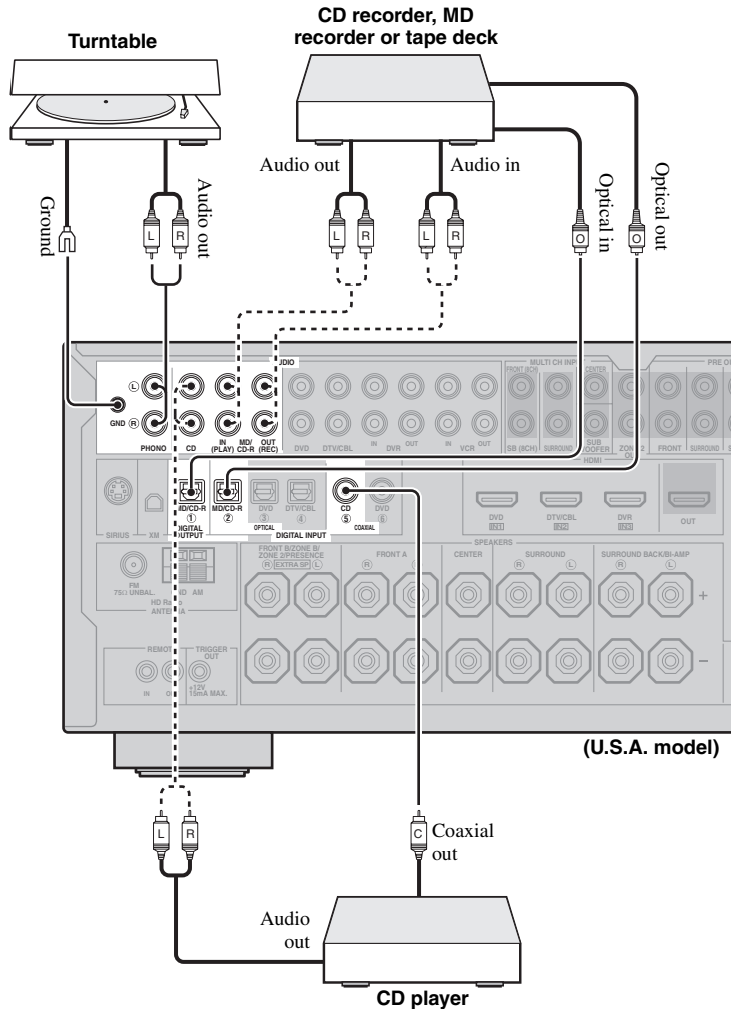

■ Connecting an external amplifier

This unit has more than enough power for any home use. However, if you want to add more power to the speaker output or if you want to use another amplifier, connect an external amplifier to the PRE OUT jacks. Each PRE OUT jack outputs the same channel signals as the corresponding SPEAKERS terminals.

Notes

- When you make connections to the PRE OUT jacks, do not make connections to the SPEAKERS terminals.
- The signals output at the FRONT PRE OUT jacks are affected by the TONE CONTROL settings (see page 52).
- Adjust the volume level of the subwoofer with the control on the subwoofer (see page 52).
- Some signals may not be output at the SUBWOOFER PRE OUT jacks depending on the settings for “SPEAKER SET” (see page 87).

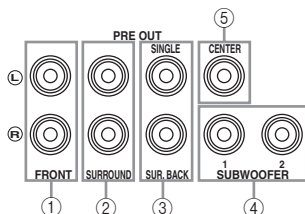

① FRONT PRE OUT jacks

Front channel output jacks.

② SURROUND PRE OUT jacks

Surround channel output jacks.

③ SUR.BACK PRE OUT jacks

Surround back channel output jacks. When you only connect one external amplifier for the surround back channel, connect it to the SINGLE jack.

Notes

- When “BI-AMP” is set to “ON”, this unit outputs the front channel audio signals at the SUR.BACK PRE OUT jacks.
- The audio signals output at the SUR.BACK PRE OUT jacks differ depending on the “EXTRA SP ASSIGN” setting (see pages 33 and 87).

④ SUBWOOFER PRE OUT jacks

Connect one or two subwoofers with a built-in amplifier.

Note

The signal output at the SUBWOOFER PRE OUT 2 jack is the same as the one output at the SUBWOOFER PRE OUT 1 jack.

⑤ CENTER PRE OUT jack

Center channel output jack.

■ Connecting a multi-format player or an external decoder

This unit is equipped with 6 additional input jacks (left and right FRONT, CENTER, left and right SURROUND and SUBWOOFER) for discrete multi-channel input from a multi-format player, external decoder, sound processor or pre-amplifier.

If you set "INPUT CH" to "8CH" in "MULTI CH" (see page 97), you can use the input jacks assigned as "FRONT" in "MULTI CH" (see page 97) together with the MULTI CH INPUT jacks to input 8-channel signals.

Connect the output jacks on your multi-format player or external decoder to the MULTI CH INPUT jacks. Be sure to match the left and right outputs to the left and right input jacks for the front and surround channels.

Notes

- When you select the component connected to the MULTI CH INPUT jacks as the input source (see page 43), this unit automatically turns off the digital sound field processor, and you cannot select sound field programs.
- This unit does not redirect signals input at the MULTI CH INPUT jacks to accommodate for missing speakers. We recommend that you connect at least a 5.1-channel speaker system before using this feature.

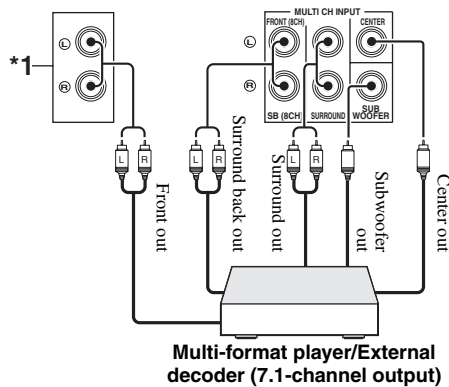
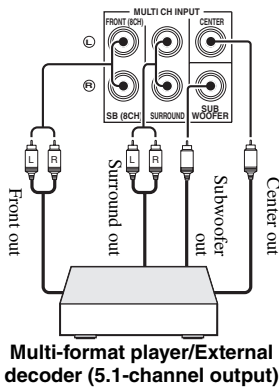

*1 The analog audio input jacks assigned as "FRONT" in "MULTI CH" (see page 97).

■ Connecting a Yamaha iPod universal dock or Bluetooth adapter

This unit is equipped with the DOCK terminal on the rear panel that allows you to connect a Yamaha iPod universal dock (such as YDS-10, sold separately) or Bluetooth adapter (such as YBA-10 sold separately). Connect a Yamaha iPod universal dock or Bluetooth adapter to the DOCK terminal on the rear panel of this unit using its dedicated cable.



Refer to "Using iPod™" on page 70 for playback of your iPod and "Using Bluetooth™ components" on page 72 for playback of your Bluetooth components.

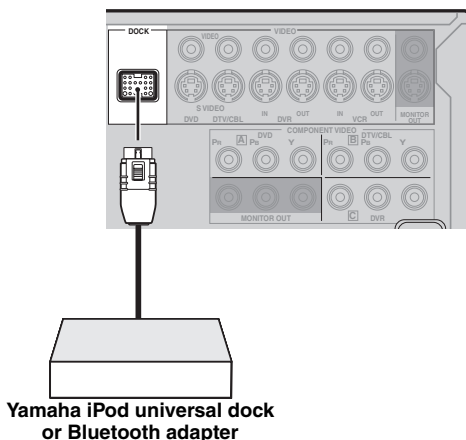

■ Using REMOTE IN/OUT jacks

When the components are the Yamaha products and have the capability of the transmission of the remote control signals, connect the REMOTE IN jack and REMOTE OUT jack to the remote control input and output jack with the monaural analog mini cable as follows.

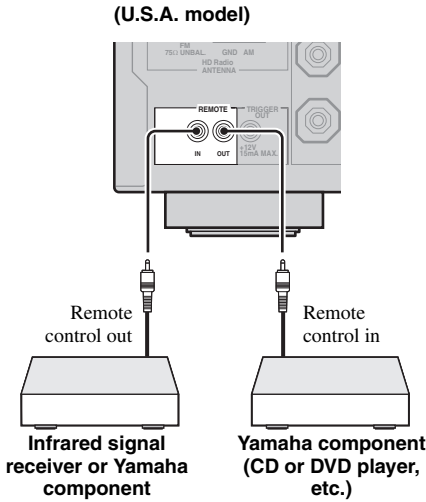

- If the components have the capability of the SCENE control signals, this unit can automatically activate the corresponding components and start the playback when you use one of the SCENE buttons. Refer to the owner's manuals for details about the capability of the SCENE control signals of the components.
- If the component connected to the REMOTE OUT jack is not the Yamaha product, set "SCENE IR" in the advanced setup menu to "OFF" (see page 112).

Using the VIDEO AUX jacks on the front panel

Use the VIDEO AUX jacks on the front panel to connect a game console or a video camera to this unit.

Caution

Be sure to turn down the volume of this unit and other components before making connections.

Notes

- The audio signals input at the DOCK terminal on the rear panel take priority over the ones input at the VIDEO AUX jacks.
- To reproduce the source signals input at these jacks, select "V-AUX" as the input source.

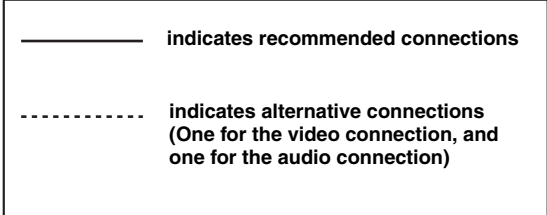
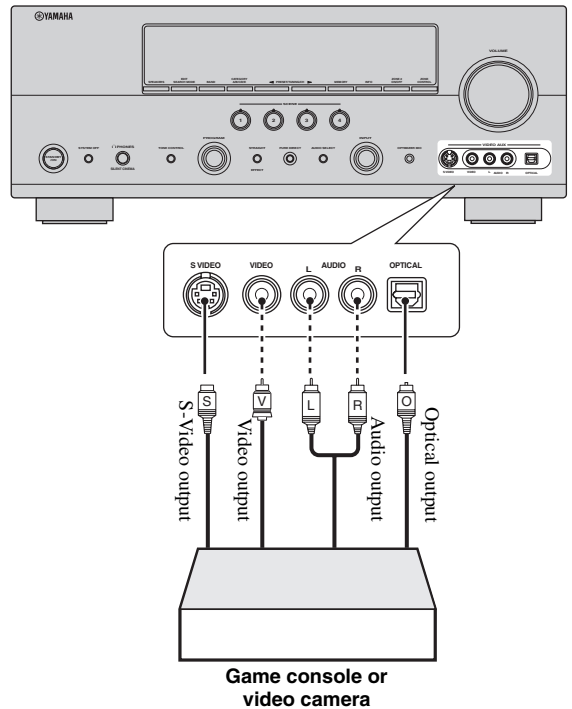

Connecting the FM and AM antennas

Both FM and AM indoor antennas are supplied with this unit. Connect each antenna correctly to the designated terminals. In general, these antennas should provide sufficient signal strength.

Notes

- The AM loop antenna should be placed away from this unit.
- A properly installed outdoor antenna provides clearer reception than an indoor one. If you experience poor reception quality, install an outdoor antenna. Consult the nearest authorized Yamaha dealer or service center about outdoor antennas.
- The AM loop antenna should always be connected, even if an outdoor AM antenna is connected to this unit.

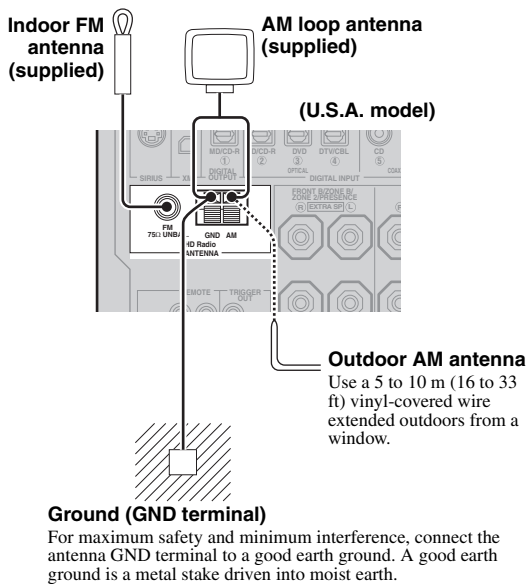

Connecting the wire of the AM loop antenna

(U.S.A. model)

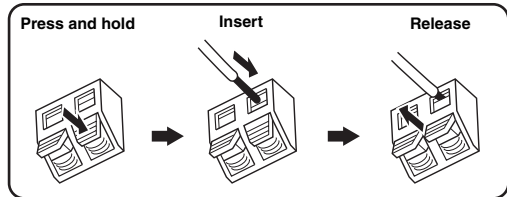

(Canada model)

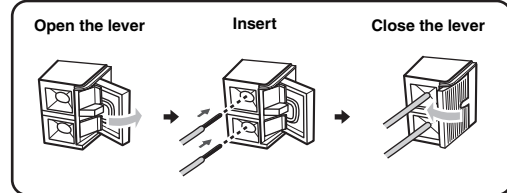

The wire of the AM loop antenna does not have any polarity and you can connect either end of the wire to AM or GND terminal.

Assembling the supplied AM loop antenna

(U.S.A. model)

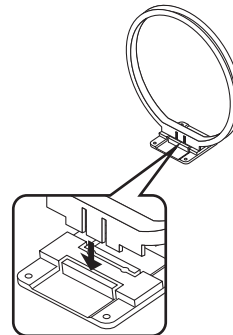

(Canada model)

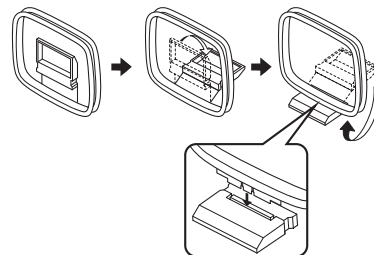

Connecting the power cable

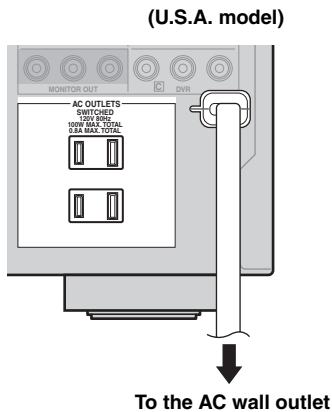

■ AC OUTLETS (SWITCHED)

Use these 2 outlets to supply power to any connected components. Connect the power cable of your other components to these 2 outlets. Power to these 2 outlets is supplied when this unit is turned on. However, power to these 2 outlets is cut off when this unit is turned off. For information on the maximum power or the total power consumption of the components that can be connected to these 2 outlets, see “Specifications” on page 127.

Note

The power to AC OUTLETS of this unit is not cut off while this unit is charging connected iPod even when this unit is in the standby mode. When this unit completes charging or the iPod is disconnected, the power is cut off automatically when this unit is in the standby mode.

Memory back-up

The memory back-up circuit prevents the stored data from being lost even if this unit is in the standby mode. However, the stored data will be lost in case the power cable is disconnected from the AC wall outlet or if the power supply is cut off for more than one week.

Setting the speaker impedance

Caution

If you are to use 6 ohm speakers, set “SP IMP.” to “6Ω MIN” as follows BEFORE using this unit. 4 ohm speakers can be also used as the front speakers.

- 1 Press **L SYSTEM OFF** on the front panel to turn off this unit.
See page 29 for details.
- 2 Press and hold **M TONE CONTROL** and then press **K MAIN ZONE ON/OFF** to turn on this unit.
This unit turns on, and the advanced setup menu appears in the front panel display.



- 3 Rotate the **N PROGRAM** selector to select “SP IMP.”.
“SP IMP.” and the current speaker impedance setting (“8Ω MIN”) appear in the front panel display.
- 4 Press **M TONE CONTROL** repeatedly to select “6Ω MIN”.
- 5 Press **L SYSTEM OFF** to save the new setting and turn off this unit.

Note

The setting you made is reflected next time you turn on this unit.

Turning this unit on and off

■ Turning on this unit

Press **K MAIN ZONE ON/OFF** (or **14 POWER**) to turn on this unit.

The main zone is turned on.



- When you turn on this unit, there will be delay for a few seconds before this unit can reproduce sound.
- You can also turn on the main zone by pressing **SCENE** (or **SCENE**) buttons.

■ Set the main zone to the standby mode

Press **K MAIN ZONE ON/OFF** (or **13 STANDBY**) to set the main zone to the standby mode.

In the standby mode, this unit consumes a small amount of power in order to receive infrared signals from the remote control.



Press **L SYSTEM OFF** to set the main zone and Zone 2 (see page 108) to the standby mode simultaneously.

Front panel display

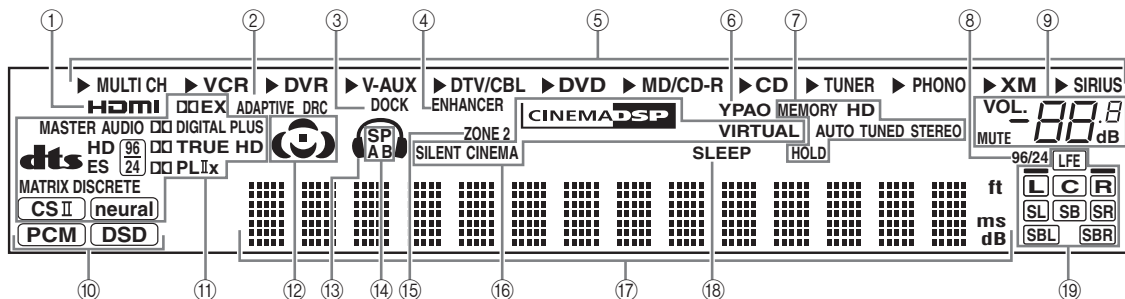

① HDMI indicator

Lights up when the signal of the selected input source is input at the HDMI IN jacks (see page 18).

② ADAPTIVE DRC indicator

Lights up when the adaptive dynamic range control feature is turned on (see page 91).

③ DOCK indicator

- Lights up when you station your iPod in a Yamaha iPod universal dock (such as YDS-10, sold separately) connected to the DOCK terminal of this unit (see page 25) and V-AUX is selected as the input source. The DOCK indicator also lights up when this unit is charging the battery of the stationed iPod in the standby mode.
- Flashes while the connected Yamaha Bluetooth adapter (such as YBA-10, sold separately) and the Bluetooth component is in the pairing or the Bluetooth adapter is searching the Bluetooth component (see page 72).
- Light up while the Yamaha Bluetooth adapter is connected to the Bluetooth component (see page 72).

④ ENHANCER indicator

Lights up when the Compressed Music Enhancer mode is selected (see page 50).

⑤ Input source indicators

The corresponding cursor lights up to show the currently selected input source.

Note

The XM and SIRIUS indicator is only applicable to the U.S.A. and Canada models and the cursor on the left of the XM indicator or SIRIUS indicator lights up only when “XM” or “SIRIUS” is selected as the input source.

⑥ YPAO indicator

Lights up when you run “AUTO SETUP” and when the speaker settings set in “AUTO SETUP” are used without any modifications (see page 32).

⑦ Tuner indicators

Lights up when this unit is in the FM, AM, XM Satellite Radio, or SIRIUS Satellite Radio tuning mode (see pages 53 to 69).

Note

HD indicator is only applicable to the U.S.A. model only and lights up when this unit is turned into the HD Radio reception band.

⑧ 96/24 indicator

Lights up when a DTS 96/24 signal is input to this unit.

⑨ MUTE indicator and VOLUME level indicator

- The MUTE indicator flashes while the MUTE function is on (see page 45).
- Indicates the current volume level.

⑩ Input signal indicators

Lights up when this unit is reproducing PCM (Pulse Code Modulation) or DSD (Direct Stream Digital) digital audio signals.

⑪ Decoder indicators

The respective indicator lights up when any of the decoders of this unit function.

Note

The neural indicator is only applicable to the U.S.A. and Canada models and CSII indicator is only applicable to the U.S.A. model.

⑫ Sound field indicators

Light up to indicate the active sound fields (see page 48).

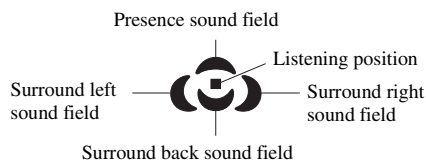

⑬ Headphone indicator

Lights up when headphones are connected (see page 45).

⑭ SP A B indicators

Light up according to the set of front speakers activated (see page 43).

SP A: The FRONT A speakers are activated.

SP B: The FRONT B speakers are activated.

SP A B: The FRONT A and FRONT B speakers are activated.

⑮ ZONE2 indicator

Lights up when Zone 2 is turned on (see page 107).

⑯ DSP indicators

The respective indicator lights up when any of the sound field programs are selected (see page 48).

CINEMA DSP indicator

Lights up when you select a CINEMA DSP sound field program (see page 48).

VIRTUAL indicator

Lights up when the Virtual CINEMA DSP mode is active (see page 51).

SILENT CINEMA indicator

Lights up when headphones are connected and a sound field program is selected (see page 51).

⑰ Multi-information display

Shows the name of the current sound field program and other information when adjusting or changing settings.

⑱ SLEEP indicator

Lights up while the sleep timer is on (see page 47).

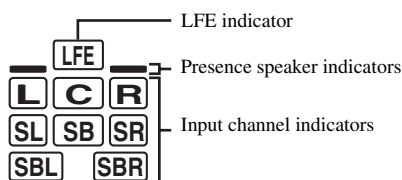
⑲ Input channel and speaker indicators**Input channel indicators**

- Indicate the channel components of the current digital input signal.
- Light up or flash according to the settings of the speakers when this unit is in the automatic setup procedure (see page 32) or in the “BASIC MENU” in “MANUAL SETUP” (see page 89).

Presence speaker indicators

Light up or flash according to the setting of “EXTRA SP ASSIGN” when this unit is in the automatic setup procedure (see page 32) or in the “BASIC MENU” in “MANUAL SETUP” (see page 87).



You can make settings for the presence and surround back speakers automatically by running “AUTO SETUP” (see page 32) or manually by adjusting settings for “SUR.B L/R SP” (see page 88) in “SPEAKER SET”.

Using the remote control

The remote control transmits a directional infrared ray. Be sure to aim the remote control directly at the remote control sensor on this unit during operation.

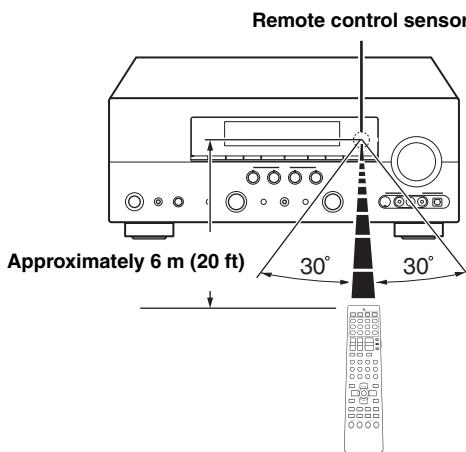
**Infrared window (①)**

Outputs infrared control signals. Aim this window at the component you want to operate.

⑳ TRANSMIT indicator

Flashes while the remote control is sending infrared signals.

Operation mode selector (⑲)

The function of some buttons depends on the operation mode selector position.

AMP

Operates the amplifier function of this unit.

SOURCE

Operates the component selected with an input selector button (see page 103).

TV

Operates the TV assigned to either ④ DTV/CBL or ④ PHONO (see page 102).

Notes

- Do not spill water or other liquids on the remote control.
- Do not drop the remote control.
- Do not leave or store the remote control in the following types of conditions:
 - places of high humidity, such as near a bath
 - places of high temperatures, such as near a heater or stove
 - places of extremely low temperatures
 - dusty places
- To set the remote control codes for other components, see page 104.

Optimizing the speaker setting for your listening room (YPAO)

This unit employs the YPAO (Yamaha Parametric Room Acoustic Optimizer) technology which lets you avoid troublesome listening-based speaker setup and achieves highly accurate sound adjustments automatically. The supplied optimizer microphone collects and this unit analyzes the sound your speakers produce in your actual listening environment.

Using AUTO SETUP

Notes

- Be advised that it is normal for loud test tones to be output during the “AUTO SETUP” procedure.
 - To achieve the best results, make sure the room is as quiet as possible while the “AUTO SETUP” procedure is in progress. If there is too much ambient noise, the results may not be satisfactory.
- ☀
- Initial settings are indicated in bold.
 - You can run “AUTO SETUP” using the system menu that appears in the OSD or in the front panel display. This manual uses the OSD illustrations to explain the “AUTO SETUP” procedure.
 - Before performing operations, set the operation mode selector on the remote control to **AMP**.
 - This unit uses the speakers connected to the FRONT A speaker terminals as the front speakers for the adjustment.

1 Make sure of the following check points.

Note

Before starting the automatic setup, check the following check points.

- Speakers are connected appropriately.
- Headphones are disconnected from this unit.
- This unit and the video monitor are turned on.
- This unit is selected as the video input source of the video monitor.
- The connected subwoofer is turned on and the volume level is set to about half way (or slightly less).
- The crossover frequency controls of the connected subwoofer is set to the maximum.

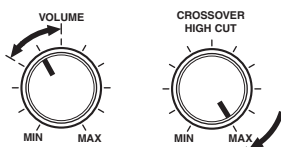

Controls of a subwoofer (example)

- The room is sufficiently quiet.



If you connect two subwoofers to this unit, the volume level of each subwoofer is set to slightly less.

2 Connect the supplied optimizer microphone to the OPTIMIZER MIC jack on the front panel.

“MIC ON View OSD menu” appears in the front panel display.

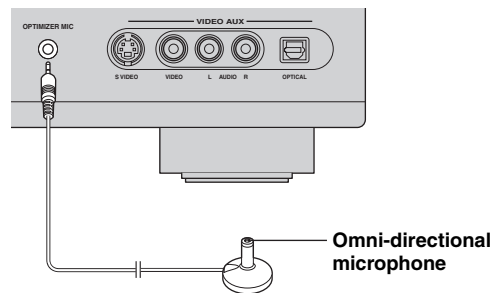

The following menu screen appears on the video monitor.

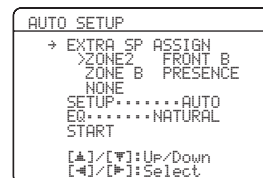

3 Place the optimizer microphone at your normal listening position on a flat level surface with the omni-directional microphone heading upward.

Optimizer microphone

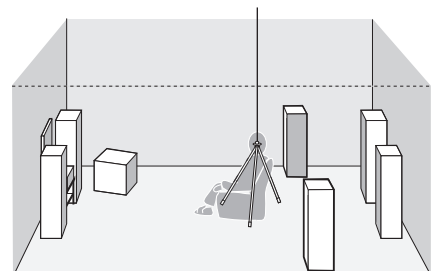

It is recommended that you use a tripod (etc.) to affix the optimizer microphone at the same height as your ears would be when you are seated in your listening position. You can use the attached screw of a tripod (etc.) to fix the optimizer microphone to the tripod (etc.).

4 Press **Ⓢ** < / > to select the desired setting for “EXTRA SP ASSIGN” and then press **Ⓢ** ∇.

Extra speaker assignment

EXTRA SP ASSIGN

Selects the function of the speakers connected to the EXTRA SP terminals.

Choices: **FRONT B**, ZONE2, ZONE B, PRESENCE, NONE

- **When you use the alternative front speaker system (see page 43)**
Select “FRONT B”.
- **When you use the Zone 2 speakers (see page 107)**
Select “ZONE2” to set the function of the speakers to the Zone 2 speakers. This unit drives the Zone 2 speakers by using the internal amplifier.
- **When you want to use another front speaker system in Zone B**
Select “ZONE B”.
- **When you use the presence speakers (see page 13)**
Select “PRESENCE” to set the function of the speakers to the presence speakers.
- **When you do not use the EXTRA SP terminals**
Select “NONE” to deactivate the EXTRA SP terminals.

Note

If you select “ON” in “BI-AMP” (see page 112), you cannot select “PRESENCE” or “ZONE2” in “EXTRA SP ASSIGN”.

5 Press **Ⓢ** < / > to select “SETUP” and then press **Ⓢ** ∇.

Choices: **AUTO**, RELOAD, UNDO, DEFAULT

- Select “AUTO” to automatically run the entire “AUTO SETUP” procedure.
- Select “RELOAD” to reload the last “AUTO SETUP” settings and override the previous settings.
- Select “UNDO” to undo the last “AUTO SETUP” settings and restore the previous settings.
- Select “DEFAULT” to reset the “AUTO SETUP” parameters to the initial factory settings.

Notes

- “RELOAD” or “UNDO” is available only when you have previously run “AUTO SETUP” and confirmed the results.
- “RELOAD” or “UNDO” is not available when you change the setting of “BI-AMP” in the advanced setup (see page 112) or “EXTRA SP ASSIGN” in “BASIC MENU” (see page 87).

6 Press **Ⓢ** < / > to select the desired setting of “EQ”.

Parametric equalizer type EQ

Parametric equalizer adjusts the level of the specified frequency bands. This unit automatically selects the crucial frequency bands for the listening room and adjusts the level of the selected frequency bands to create a cohesive sound field in the room. You can select the type of the parametric equalizer adjustment from the following choices.

Choices: **NATURAL**, FLAT, FRONT

- Select “NATURAL” to average out the frequency response of all speakers with higher frequencies being all speakers to achieve more natural sound. Recommended if the FLAT setting sounds a little harsh.
- Select “FLAT” to average the frequency response of all speakers. Recommended if all of your speakers are of similar quality.
- Select “FRONT” to adjust the frequency response of each speaker in accordance with the sound of your front speakers. Recommended if your front speakers are of much higher quality than your other speakers.

7 Press $\text{O} \nabla$ to select “START” and then press $\text{O} \text{ENTER}$ to start the setup procedure.

The following message appears in the OSD. When this unit starts the automatic setup procedure, loud test tones are output at the speakers. For more accurate measurements, keep quiet and move to the wall where speakers are not around. We recommend that you leave the listening room during the automatic setup procedure.

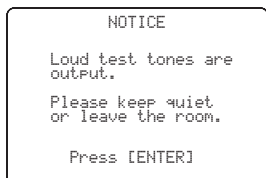

Once you perform the next operation, this unit starts the automatic setup procedure.

8 Press $\text{O} \text{ENTER}$ to start the automatic setup procedure.

The following screen appears in the OSD and setup procedure starts in 10 seconds.

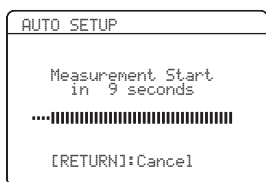

Loud test tones are output from each speaker during the auto setup procedure. Once all items are set, the “RESULT” display appears in the OSD.

Notes

- During the automatic setup procedure, do not perform any operation on this unit.
- We recommend that you get out of the room while this unit is in the auto setup procedure. It takes approximately 3 minutes for this unit to complete the auto setup procedure.



Press $\text{O} \Delta$ to cancel the automatic setup procedure.

9 Make sure that the following screen appears and then press $\text{O} \text{ENTER}$ to display the result screen.

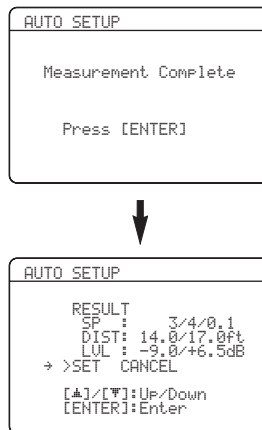

The results displayed under “RESULT” are as follows:

Number of speakers SP

Displays the number of speakers connected to this unit in the following order: Front/Back/Subwoofer

Speaker distance DIST

Displays the speaker distance from the listening position in the following order: Closest speaker distance/Farthest speaker distance

Speaker level LVL

Displays the speaker output level in the following order: Lowest speaker output level/Highest speaker output level

Notes

- The signal output at the SUBWOOFER PRE OUT 2 jack is the same as the one output at the SUBWOOFER PRE OUT 1 jack. Therefore, even if you connect two subwoofers, the number of the connected subwoofer is indicated as “0.1”.
- If “E-10:INTERNAL ERROR” appears during the testing procedure, restart from step 4.
- If you selected other than “AUTO” in step 5, no test tones are output.
- If an error occurs during the “AUTO SETUP” procedure, the setup procedure is canceled and an error screen appears. For details, see “If an error screen appears” on page 36.
- When this unit detects potential problems during the “AUTO SETUP” procedure, “WARNING” and the number of warning messages appears in the above of “RESULT” (see page 36).
- Depending on the listening environment, “SWFR PHASE:REV” appears during the automatic procedure and “SUBWOOFER PHASE” in “SOUND MENU” (see page 89) is automatically set to “REVERSE”.

10 Press **Ⓢ** **△** and then **Ⓢ** **ENTER** to display the setup results in detail.

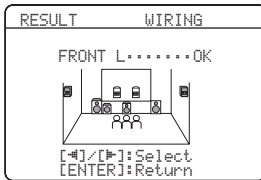
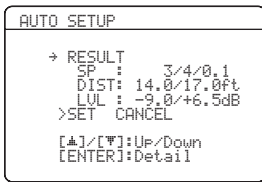

11 Press **Ⓢ** **</>** repeatedly to toggle between the setup result displays.

Press **Ⓢ** **△** / **▽** to toggle between the parameters in a results.

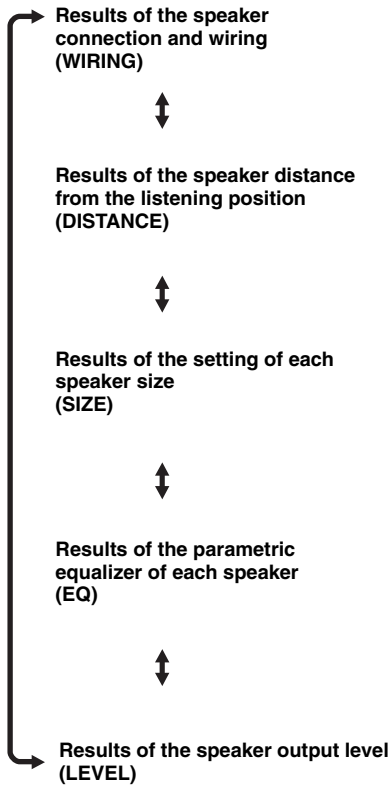

If you are not satisfied with the results or want to manually adjust each parameter, use “MANUAL SETUP” (see page 82).

Notes

- The distances displayed in the “DISTANCE” results may be longer than the actual distance depending on the characteristics of your subwoofer.
- In the “EQ” results, different values may be set for the same frequency to provide finer adjustments.

12 Press **Ⓢ** **ENTER** to return to the top result display.

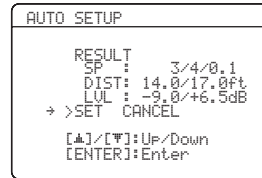

13 Make sure the pointer is pointing at “SET” and “CANCEL” and then press **Ⓢ** **</>** to select “SET” or “CANCEL”.

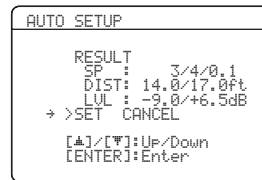

Choices: **SET**, **CANCEL**

- Select “SET” to confirm the “AUTO SETUP” results.
- Select “CANCEL” to cancel the “AUTO SETUP” results.

14 Press **Ⓢ** **ENTER** to confirm your selection.

The following screen appears. Disconnect the optimizer microphone from this unit. The optimizer microphone is sensitive to heat. Keep it away from direct sunlight and do not place it on top of this unit.



15 Press $\text{\textcircled{E}}$ ENTER to confirm your selection.

The top “SET MENU” screen appears in the OSD.

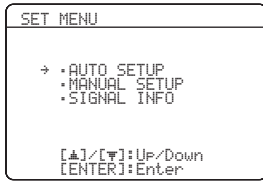

16 Press $\text{\textcircled{S}}$ SET MENU to exit from “SET MENU”.



If you change speakers, speaker positions, or the layout of your listening environment, run “AUTO SETUP” again to recalibrate your system.

■ If an error screen appears

Press $\text{\textcircled{\Delta}}$ / $\text{\textcircled{\nabla}}$ / $\text{\textcircled{<}}$ / $\text{\textcircled{>}}$ to select “RETRY” or “EXIT” and then press $\text{\textcircled{E}}$ ENTER.

The following display is an example when “E-9:USER CANCEL” appears in the OSD.

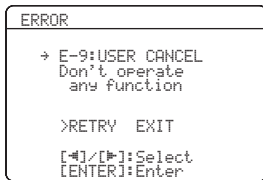

Choices: **RETRY**, **EXIT**

- Select “RETRY” to retry the “AUTO SETUP” procedure.
- Select “EXIT” to exit from the “AUTO SETUP” procedure.



If “E-5:NOISY” appears, “PROCEED” also appears in the choices. When you select “PROCEED”, this unit continues the measurements and settings, but the settings may not be optimal.

■ If “WARNING” appears

When this unit detects potential problems during the “AUTO SETUP” procedure, “WARNING” appears in the top result display. Check the warning messages to correct your speaker settings.

Note

Warnings differ from errors in that warnings do not cancel the “AUTO SETUP” procedure.

1 Make sure the pointer is pointing at “WARNING” and then press $\text{\textcircled{E}}$ ENTER to display the detailed information about the warning.

The number on the right of “WARNING” indicates the number of warning messages.

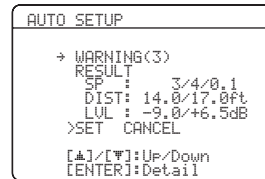

2 Press $\text{\textcircled{<}}$ / $\text{\textcircled{>}}$ repeatedly to toggle between the warning displays.

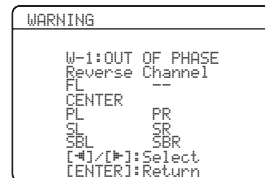

- For details about each warning message, see the “AUTO SETUP” section in “Troubleshooting” on page 120.
- When the corresponding warning message is not applicable to a speaker, “—” is displayed instead.
- If “SWFR: TOO LOUD” or “SWFR: TOO LOW” appears in the “W-3: LEVEL ERROR” display, adjust the volume level of the subwoofer(s).

3 Press $\text{\textcircled{E}}$ ENTER to return to the top result display.

Selecting the SCENE templates

This unit is equipped with 19 preset SCENE templates for various situations of using this unit. As the initial factory setting, the following SCENE templates are assigned to each SCENE button (see page 8):

- SCENE 1:** DVD Viewing
- SCENE 2:** Disc Listening
- SCENE 3:** TV Viewing
- SCENE 4:** Radio Listening

If you want to use other SCENE templates, you can select the desired SCENE templates from the SCENE template library and assign the templates to the selected SCENE buttons on the front panel and the remote control.

Select the desired SCENE template

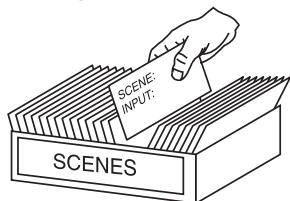

SCENE template library (Image)



Assign the SCENE template to the SCENE button

- 2 Rotate the **ⓇINPUT** selector (or set the operation mode selector to **ⓈAMP** and then press **Ⓢ◀/▶**) to select the desired template.

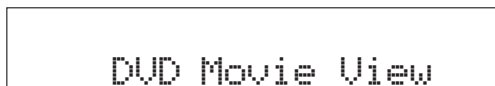

- 3 Press the **ⓈSCENE** (or **ⓈSCENE**) button again to confirm the selection.

The selected SCENE template is assigned to the SCENE button.



Front panel

or



Remote control

Note

Once the desired SCENE templates are assigned to the corresponding SCENE buttons, you need to set the input source of the SCENE template on the remote control. See page 41 for details.

Selecting the desired SCENE template to the SCENE buttons

- 1 Press and hold the **ⓈSCENE** (or **ⓈSCENE**) button for 3 seconds.

The indicator on the selected SCENE button on the front panel starts to flash, and the name of the currently assigned SCENE template appears in the front panel display.

3 seconds



Front panel

or

3 seconds



Remote control



Flashes



■ Which SCENE template would you like to select?

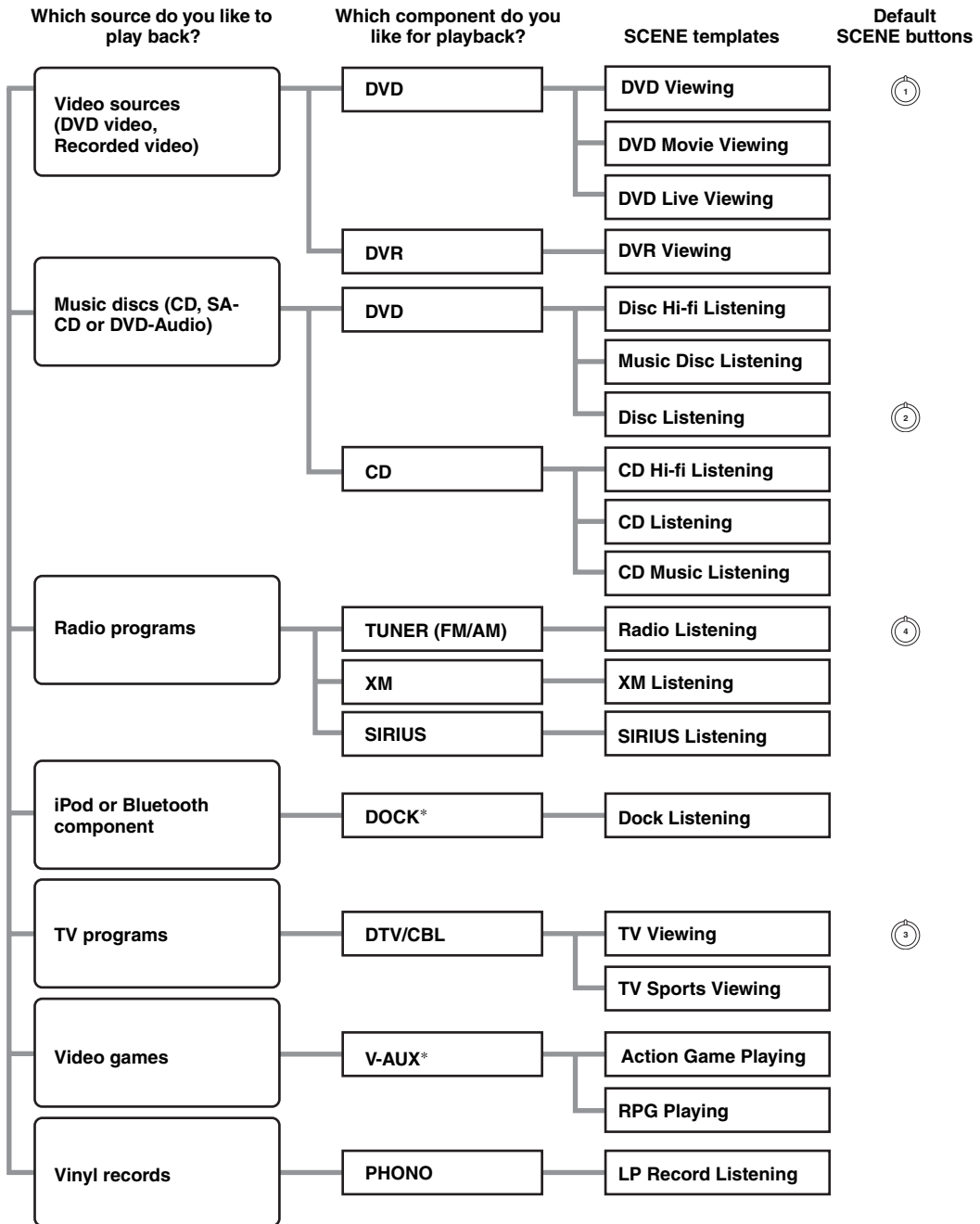

Note





* When iPod is connected to the Yamaha iPod universal dock or a Bluetooth component is connected to the Bluetooth adapter, this unit plays back the audio sources input at the DOCK terminal.



You can create your original SCENE templates by editing the preset SCENE templates. See page 40 for details.

■ Preset SCENE templates descriptions

The illustrations of the SCENE button in the following table indicate the assigned SCENE buttons in the default setting.

| SCENE template | Input source | Playback mode | Features |
|---|--------------|---|---|
| DVD Viewing  | DVD* | Straight | Select this SCENE template when you play back general contents on the DVD player. |
| DVD Movie Viewing | DVD* | MOVIE Sci-Fi | Select this SCENE template when you play back movies on your DVD player. |
| DVD Live Viewing | DVD* | ENTERTAINMENT Music Video | Select this SCENE template when you enjoy the music live video on your DVD player. |
| DVR Viewing | DVR | MOVIE Drama | Select this SCENE template when you play back movies on your digital video recorder. |
| Disc Hi-fi Listening | DVD* | Pure Direct | Select this SCENE template when you enjoy the high fidelity sound of the music discs on your DVD player. |
| Music Disc Listening | DVD* | STEREO 2ch Stereo | Select this SCENE template when you play back music discs on your DVD player. |
| Disc Listening  | DVD* | STEREO 7ch Stereo | Select this SCENE template when you play back music sources on your DVD player as the background music. |
| CD Hi-fi Listening | CD* | Pure Direct | Select this SCENE template when you enjoy the high fidelity sound of the music discs on your CD player. |
| CD Listening | CD* | STEREO 7ch Stereo | Select this SCENE template when you play back music discs on your CD player. |
| CD Music Listening | CD* | STEREO 2ch Stereo | Select this SCENE template when you play back music source on your CD player as the background music. |
| Radio Listening  | TUNER | MUSIC ENHANCER 7ch Enhancer | Select this SCENE template when you enjoy FM or AM radio programs. |
| XM Listening | XM | MUSIC ENHANCER 7ch Enhancer | Select this SCENE template when you enjoy XM Satellite Radio programs. |
| SIRIUS Listening | SIRIUS | MUSIC ENHANCER 7ch Enhancer | Select this SCENE template when you enjoy SIRIUS Satellite Radio programs. |
| Dock Listening | V-AUX | MUSIC ENHANCER 7ch Enhancer | Select this SCENE template when you play back music on your iPod stationed in a Yamaha iPod universal dock or Bluetooth component that is connected to the Bluetooth adapter. |
| TV Viewing  | DTV/CBL | Straight | Select this SCENE template when you enjoy general programs on your TV. |
| TV Sports Viewing | DTV/CBL | ENTERTAINMENT Sports | Select this SCENE template when you enjoy sports programs on your TV. |
| Action Game Playing | V-AUX | ENTERTAINMENT Action Game | Select this SCENE template when you play action games such as car racing and FPS games. |
| RPG Playing | V-AUX | ENTERTAINMENT Roleplaying Game | Select this SCENE template when you play role-playing games. |
| LP Record Listening | PHONO | Pure Direct | Select this SCENE template when you play back vinyl records on your turntable. |

* When the connected DVD player or CD player has the capability of the SCENE control signals and is connected to the REMOTE OUT jack of this unit, this unit operates the DVD player or CD player worked with the SCENE features.

Creating your original SCENE templates

You can create your original SCENE templates for each SCENE button. You can refer to the preset 19 SCENE templates to create the original SCENE templates.

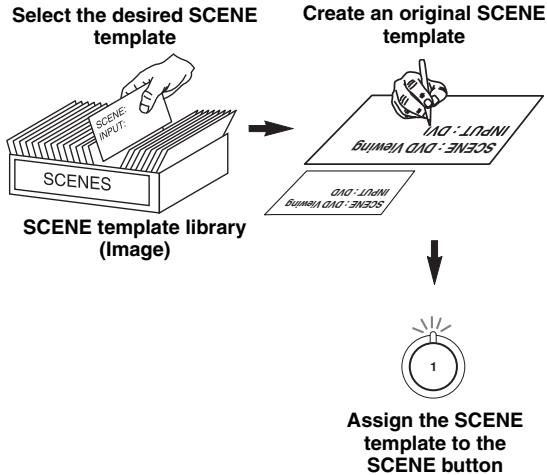

1 Turn on the video monitor connected to this unit.

2 Press and hold the desired SCENE button for 3 seconds.

The SCENE template customizing screen appears on the video monitor.

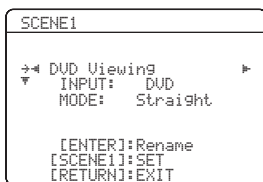

Note

When the SCENE template you want to customize is not assigned to any of the SCENE buttons, press SCENE repeatedly to recall the desired SCENE template on the menu screen.

3 Press SCENE / SCENE to select the desired parameter of the SCENE template and then SCENE / SCENE to select the desired value of the selected parameter.

You can adjust the following parameters for a SCENE template:

- **INPUT:** The input source component.
- **MODE:** The active sound field programs, “Straight” or “Pure Direct” mode.

4 Press the SCENE button again to confirm the edit.



An asterisk mark (*) appears by the name of the original SCENE template.

Notes

- Once the desired SCENE templates are assigned to the corresponding SCENE buttons, you need to set the input source of the SCENE template on the remote control. See page 41 for details.
- You can create a customized SCENE template for each SCENE button, and if you create another customized SCENE template, this unit overwrites the old customized SCENE template with the new one.
- The newly created template is only available for the assigned SCENE button.

■ Rename the SCENE templates

Select the name of the SCENE template at step 3 of “Creating your original SCENE templates” and then press ENTER .

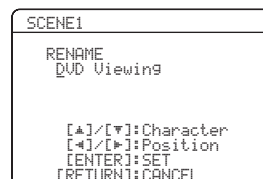

- Press SCENE / SCENE to select the desired character.
- Press SCENE / SCENE to place an “_” (underscore) under the space or the desired character.
- Press RETURN to cancel the new name.
- Press ENTER to confirm the new name.

Using the remote control for the SCENE feature

■ Controlling the input source components in the SCENE mode

You can operate both this unit and the input source component by using the remote control. You must set the appropriate remote control code for each input source in advance (see page 104).

Before performing the following operations, set the operation mode selector on the remote control to **ⓇSOURCE**.

- 1** Press the desired **ⓈSCENE** button on the remote control.
- 2** Press the desired buttons in the * area below to control the input source component of the selected SCENE template.

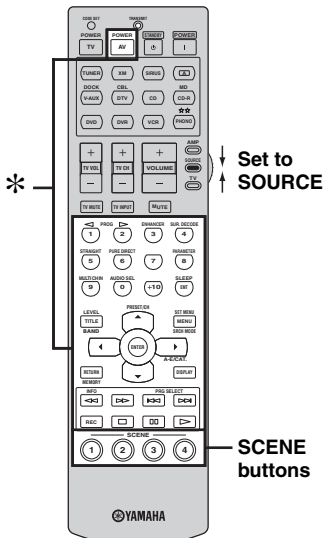

Note

* These buttons control the input source component. See page 103 for details of the function of each button.

■ Setting the input source of the customized SCENE template on the remote control

If you customize the input source of the selected SCENE template, you must set the input source of the SCENE template on the remote control to operate the input source component correctly.

- 1** Press the desired **ⓈSCENE** button on the remote control.
- 2** Press and hold the **ⓈSCENE** button and the desired input selector button (**Ⓞ**).
The **ⓉTRANSMIT** indicator flashes twice.
- 3** Keep holding down the buttons pressed in step 2 until the **ⓉTRANSMIT** indicator flashes twice again.

Note

If the setting of the input source is not successful, the **ⓉTRANSMIT** indicator flashes repeatedly. In this case, repeat the setup procedure.

Playback

Caution

Extreme caution should be exercised when you play back CDs encoded in DTS. If you play back a CD encoded in DTS on a DTS-incompatible CD player, you will only hear some unwanted noise that may damage your speakers. Check whether your CD player supports CDs encoded in DTS. Also, check the sound output level of your CD player before you play back a CD encoded in DTS.



To play DTS-encoded CDs when using a digital audio connection, set "DECODER MODE" in "INPUT MENU" to "DTS" before the playback (see page 96).

Before performing the following operations, set the operation mode selector on the remote control to **AMP**.

Basic procedure

1 Turn on the video monitor connected to this unit.



See page 46 to display the input source information on the video monitor.

2 Rotate the **INPUT** selector (or press one of the input selector buttons (4)) to select the desired input source.

The name of the currently selected input source appears in the front panel display for a few seconds.

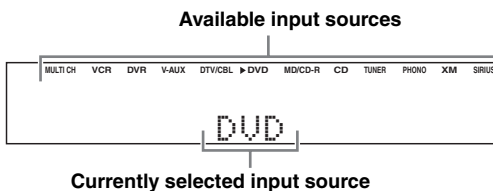

The corresponding input selector button on the remote control for the currently selected input source lights up for approximately 5 seconds after you press any buttons on the remote control, showing which source component is currently being operated.

3 Start playback on the selected source component or select a broadcast station.

- Refer to the operating instructions for the source component.
- See page 53 for details about FM or AM tuning instructions.
- See page 60 for details about XM Satellite Radio tuning instructions.
- See page 65 for details about SIRIUS Satellite Radio tuning instructions.
- See page 70 for details about iPod operations.
- See page 72 for details about Bluetooth operations.

4 Rotate **VOLUME** (or press **VOLUME +/-**) to adjust the volume to the desired output level.



- See page 52 to adjust the level of each speaker.
- This does not affect the AUDIO OUT (REC) level.
- You can set the initial volume level and maximum volume level (see page 91).

5 Rotate the **PROGRAM** selector (or press **PROG </>** repeatedly) to select the desired sound field program.

The name of the selected sound field program appears in the front panel display. See page 48 for details about sound field programs.



Note

Sound field programs cannot be selected when the component connected to the MULTI CH INPUT jacks is selected as the input source (see page 43).



- Choose a sound field program based on your listening preference, not merely on the name of the program.
- When you select an input source, this unit automatically selects the last sound field program used with the corresponding input source.
- To display information about the currently selected sound field program in the OSD, see page 74 for details.

Before performing the following operations, set the operation mode selector on the remote control to **AMP**.

Selecting the MULTI CH INPUT component

Use this feature to select the component connected to the MULTI CH INPUT jacks (see page 25) as the input source.

Rotate the **INPUT** selector to select “MULTI CH” (or press **MULTI CH IN**).

“MULTI CH” appears in the front panel display.



Use “MULTI CH” menu in “INPUT MENU” to set the parameters for MULTI CH INPUT (see page 97).

Note

Sound field programs cannot be selected when the component connected to the MULTI CH INPUT jacks is selected as the input source.

Selecting the front speaker set

Use this feature to turn the front speaker system (FRONT A and/or FRONT B) on or off.

Press **SPEAKERS** on the front panel repeatedly to turn on or off the set of front speakers connected to the FRONT A and/or EXTRA SP speaker terminals.

The active front speaker set changes as follows.

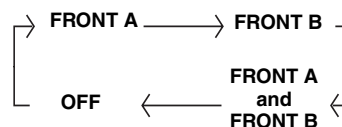

Notes

- FRONT A and B or FRONT B setting is not available when “EXTRA SP ASSIGN” is set to “PRESENCE”, “ZONE 2” or “NONE” (see page 87).
- Turn off the volume level of this unit when you switch the front speaker setting.

Using the Zone B feature

When you set “EXTRA SP ASSIGN” to “ZONE B” (see page 87), you can use the speakers connected to the EXTRA SP speaker terminals in another room (Zone B).

Press **SPEAKERS** on the front panel repeatedly to turn on or off the Zone B speakers.

When you activate the Zone B speakers, all the speakers in the main room are muted.

Note

If you select the sound field program and activate the Zone B speakers, Virtual CINEMA DSP activates automatically (see page 51).

Before performing the following operations, set the operation mode selector on the remote control to **AMP**.

Selecting audio input jacks (AUDIO SELECT)

This unit comes with a variety of input jacks. Use this feature (audio input jack select) to switch between input jacks when more than one input jack is assigned to the same input source.

- We recommend that you set the audio input jack select to "AUTO" in most cases.
- You can adjust the default audio input jack select of this unit by using "AUDIO SELECT" in "OPTION MENU" (see page 100).

Press **AUDIO SELECT** (or **AUDIO SEL**) repeatedly to select the desired audio input jack select setting.

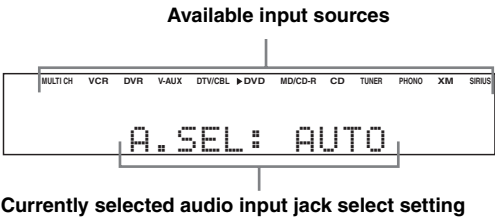

| AUDIO SELECT | Function |
|--------------|---|
| AUTO | Automatically selects input signals in the following order: (1) HDMI (2) Digital signals (3) Analog signals |
| HDMI | Selects only HDMI signals. When HDMI signals are not input, no sound is output. |
| COAX/OPT | Automatically selects input signals in the following order: (1) Digital signals input at the COAXIAL jack (2) Digital signals input at the OPTICAL jack When no signals are input, no sound is output. |
| ANALOG | Selects only analog signals. If no analog signals are input, no sound is output. |

Note

This feature is not available when no digital input jacks (OPTICAL, COAXIAL and HDMI) are assigned. In addition, HDMI is not available as an audio input jack select setting when the HDMI IN jacks are not used. Use "I/O ASSIGNMENT" in "INPUT MENU" to reassign the respective input jack (see page 95).

Displaying the current status of this unit on a video monitor

You can display the operating information of this unit on a video monitor.

- 1 Turn on the video monitor connected to this unit.
- 2 Press **DISPLAY** on the remote control. The current status screen appears in the OSD.

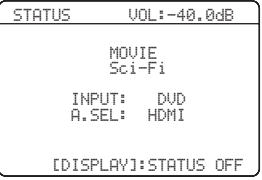

- You can select the amount of time that the current status is displayed in the OSD by using the "OSD-AMP" parameter in "OPTION MENU" (see page 98).
- To turn off the status screen, press **DISPLAY** again.

Note

The OSD signal is not output at the DVR and VCR VIDEO OUT jacks and will not be recorded.

Using your headphones

Connect a pair of headphones with a stereo analog audio cable plug to the PHONES jack on the front panel.

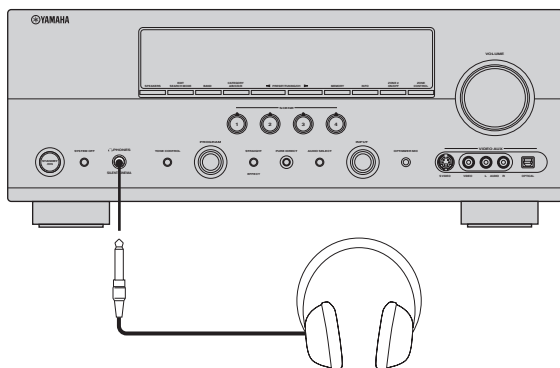

When you select a sound field program, SILENT CINEMA mode activates automatically (see page 51).

Notes

- When you connect headphones, no signals are output at the speaker terminals.
- All Dolby Digital and DTS audio signals are mixed down to the left and right headphone channels.

Muting the audio output

Press **MUTE** on the remote control to mute the audio output.

Press **MUTE** again to resume the audio output.



- You can also rotate **VOLUME** (or press **VOLUME +/-**) to resume the audio output.
- You can adjust the muting level by using the “MUTE TYPE” parameter in “VOLUME MENU” (see page 91).
- The MUTE indicator flashes in the front panel display when the audio output is muted and disappears from the front panel display when the audio output is resumed.

Before performing the following operations, set the operation mode selector on the remote control to **AMP**.

Playing video sources in the background of an audio source

You can combine a video image from a video source with sound from an audio source. For example, you can enjoy listening to classical music while viewing beautiful scenery from the video source on the video monitor.

Press the input selector buttons (4) on the remote control to select a video source and then an audio source.

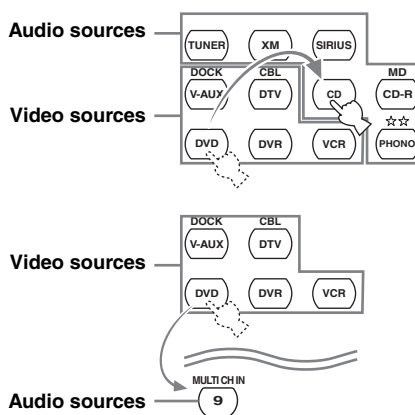

- You can also select “MULTI CH” as the audio source (see page 43). Set the operation mode selector to **AMP** and then press **MULTI CH IN**.
- Set the “BGV” parameter in the “MULTI CH” menu to the desired setting to select the default background video input source of the MULTI CH INPUT sources (see page 97).

Displaying the input source information

You can display the audio and video information of the current input signal.

- 1 Set the operation mode selector to **AMP** and then press **SET MENU** on the remote control.

The top “SET MENU” display appears in the OSD.

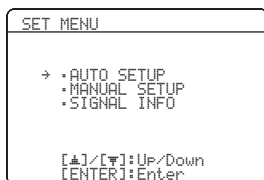

- 2 Press **▽** repeatedly to select “**SIGNAL INFO**” and then press **ENTER**.

The audio information about the input source appears in the OSD.

- 3 Press **</>** to toggle between the audio and video information displays.

- 4 Press **SET MENU** on the remote control again to exit from “**SET MENU**”.

Audio information

| Information | Descriptions |
|-------------|--|
| FORMAT | Signal format. When this unit cannot detect a digital signal, it automatically switches to analog input. |
| SAMPLING | The number of samples per second taken from a continuous signal to make a discrete signal. |
| CHANNEL | The number of source channels in the input signal (front/surround/LFE). For example, a multi-channel soundtrack with 3 front channels, 2 surround channels and LFE, is displayed as “3/2/0.1”. |
| BITRATE | The number of bits passing a given point per second. |
| FLAG | Flag data encoded in DTS, Dolby Digital, or PCM signals that cue this unit to automatically switch decoders (“Surround EX”, etc.). |

Notes

- “---” appears when this unit cannot display the corresponding information.
- (U.S.A. model only)
When the HD Radio signals include the flag data, the flag information appears. We recommend that you select “SUR. DECODE” to activate the corresponding surround decoder (see page 79).

Video information

| Information | Descriptions |
|------------------------------|---|
| HDMI SIGNAL | Type of the source video signals and the video signals output at the HDMI OUT jack of this unit. |
| HDMI RES. | Resolution of the input signal (analog or HDMI) and the output signal (HDMI). When input video signals are composite video or S-video signals, the input video signals are indicated as “Composite” or “S-Video”. |
| ANALOG RES. | Resolution of the analog video signals output at the COMPONENT VIDEO MONITOR OUT jacks of this unit. |
| HDMI ERROR (HDMI MESSAGE) | Error message for HDMI sources or connected HDMI devices. |

Note

“---” appears when this unit cannot display the corresponding information.

HDMI error and message

| Message | Cause |
|-------------|---|
| DEVICE OVER | The number of the connected HDMI components is over the limit. |
| HDCP ERROR | HDCP authentication failed. |
| Out of Res. | Out of resolution. The connected monitor is not compatible with the resolution of the input video signal. |

Using the sleep timer

Use this feature to automatically set the main zone to the standby mode after a certain amount of time. The sleep timer is useful when you are going to sleep while this unit is playing or recording a source. The sleep timer also automatically turns off any external components connected to the AC OUTLETS (see page 28).

Note

Even if this unit is in the standby mode, this unit does not cut off the power to AC OUTLETS while charging connected iPod (see page 28).

Set the operation mode selector to **AMP and then press **SLEEP** repeatedly to set the amount of time.**

Each time you press **SLEEP**, the front panel display changes as shown below.

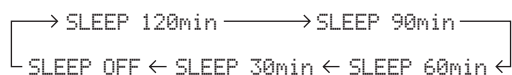

The SLEEP indicator flashes while you are switching the amount of time for the sleep timer. Once the sleep timer is set, the SLEEP indicator lights up in the front panel display, and the display returns to the selected sound field program.

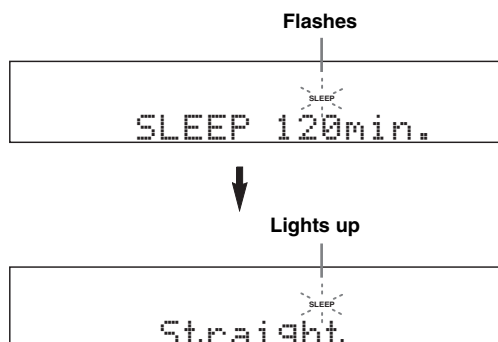

Canceling the sleep timer

Press **SLEEP** on the remote control repeatedly until "SLEEP OFF" appears in the front panel display.

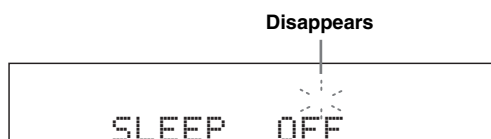

The SLEEP indicator turns off, and "SLEEP OFF" disappears from the front panel display after a few seconds.



The sleep timer setting can also be canceled by pressing **STANDBY** (or **MAIN ZONE ON/OFF**) to set the main zone to the standby mode.

Sound field programs

This unit is equipped with a variety of precise digital decoders that allow you to enjoy multi-channel playback from almost any stereo or multi-channel sound source. This unit is also equipped with a Yamaha digital sound field processing (DSP) chip containing several sound field programs which you can use to enhance your playback experience.

Selecting sound field programs

Rotate the **PROGRAM** selector (or set the operation mode selector to **AMP** and then press **PROG** \triangleleft / \triangleright repeatedly).

The name of the selected sound field program appears in the front panel display and in the OSD.

Notes

- When you select an input source, this unit automatically selects the last sound field program used with the corresponding input source.
- Sound field programs cannot be selected when the component connected to the MULTI CH INPUT jacks is selected as the input source (see page 43).
- When you play back the Dolby TrueHD, Dolby Digital Plus, DTS-HD Master Audio, or DTS-HD High Resolution Audio sources, this unit does not activate any sound field program.
- When the sampling frequency of the input sources are higher than 96 kHz, this unit does not apply any sound field programs.

Sound field program descriptions



Select a sound field program based on your listening preference, not merely on the name of the program, etc.

■ For audio music sources



For audio music sources, we also recommend that you use the Pure Direct mode (see page 52).

Notes

- The available sound field parameters differ depending on the settings of the speakers.
- "DIALG.LIFT" is available only when "EXTRA SP ASSIGN" in "SPEAKER SET" is set to "PRESENCE" (see page 87).

CLASSICAL

| Program | Descriptions |
|----------------|---|
| Hall in Munich | This sound field simulates a concert hall with approximately 2500 seats in Munich, using stylish wood for the interior finishing as normal standards for European concert halls. Fine, beautiful reverberations spread richly, creating a calming atmosphere. The listener's virtual seat is at the center left of the arena. |
| Hall in Vienna | This is an approximately 1700-seated, middle-sized concert hall with a shoebox shape that is traditional in Vienna. Pillars and ornate carvings create extremely complex reflections from all around the audience, producing a very full, rich sound. |
| Chamber | This program creates a relatively wide space with a high ceiling like an audience hall in a palace. It offers pleasant reverberations that are suitable for courtly music and chamber music. |

LIVE/CLUB

| Program | Descriptions |
|------------------|---|
| Cellar Club | This program simulates a live house with a low ceiling and homey atmosphere. A realistic, live sound field features powerful sound as if the listener is in a row in front of a small stage. |
| The Roxy Theatre | This is the sound field of a rock music live house in Los Angeles, with approximately 460 seats. The listener's virtual seat is at the center left of the hall. |
| The Bottom Line | This is the sound field at stage front in The Bottom Line, that was a famous New York jazz club once. The floor can seat 300 people to the left and right in a sound field offering real and vibrant sound. |

■ For various sources

Notes

- The available sound field parameters and the created sound fields differ depending on the input sources and the settings of this unit.
- "DIALG.LIFT" is available only when "EXTRA SP ASSIGN" in "SPEAKER SET" is set to "PRESENCE" (see page 87).

ENTERTAINMENT

| Program | Descriptions |
|------------------|--|
| Sports | This program allows the listeners to enjoy stereo sport broadcasts and studio variety programs with enriched live feeling. In sports broadcasts, the voices of the commentator and sportscaster are positioned clearly at the center while the atmosphere of the stadium expands in an optimum space to offer the listeners with a feeling of presence in the stadium. |
| Action Game | This sound field has been suitable for action games such as car racing and FPS games. It uses the reflection data that limits the effects range per channel in order to offer a powerful playing environment with a being-there feeling by enhancing various effects tones while maintaining a clear sense of directions. |
| Roleplaying Game | This sound field has been suitable for role-playing and adventure games. It combines the sound field effects for movies and the sound field designs for "Action Game" to represent the depth and 3D feeling of the field during play, while offering movie-like surround effects in the movie scenes in the game. |
| Music Video | This sound field offers an image of a concert hall for live performance of pop, rock and jazz music. The listener can indulge oneself in a hot live space thanks to the presence sound field that emphasizes the vividness of vocals and solo play and the beat of rhythm instruments, and to the surround sound field that reproduces the space of a big live hall. |

■ For movie sources



You can select the desired decoder used with following sound field program (except "Mono Movie"). See page 79 for details.

Notes

- The available sound field parameters and the created sound fields differ depending on the input sources and the settings of this unit.
- "DIALG.LIFT" is available only when "EXTRA SP ASSIGN" in "SPEAKER SET" is set to "PRESENCE" (see page 87).

MOVIE

| Program | Descriptions |
|-----------|---|
| Standard | This program creates a sound field emphasizing the surrounding feeling without disturbing the original acoustic positioning of multi-channel audio such as Dolby Digital and DTS. It has been designed with the concept of "an ideal movie theater", in which the audience is surrounded by beautiful reverberations from the left, right and rear. |
| Spectacle | This program represents the spectacular feeling of large-scale movie productions. It reproduces a broad theater sound field matching the cinemascope and wider-screen movies with an excellent dynamic range from very small to extremely large sound. |
| Sci-Fi | This program clearly reproduces the finely elaborated sound design of the latest science fiction and special effects-featuring movies. You can enjoy a variety of cinematographically created virtual spaces reproduced with clear separation between dialog, sound effects and background music. |

| Program | Descriptions |
|------------|--|
| Adventure | This program is ideal for precisely reproducing the sound design of action and adventure movies. The sound field restrains reverberations but puts emphasis on reproducing a powerful space expanded widely to the left and right. The reproduced depth is also restrained relatively to ensure the separation between audio channels and the clarity of the sound. |
| Drama | This sound field features stable reverberations that match a wide range of movie genres from serious dramas to musicals and comedies. The reverberations are modest but offer an optimum 3D feeling, reproducing effects tones and background music softly but cubically around clear words and center positioning in a way that does not fatigue the listener even after long hours of viewing. |
| Mono Movie | This program is provided for reproducing monaural video sources such as a classic movie in an atmosphere of a good old movie theater. The program produces the optimum expansion and reverberation to the original audio to create a comfortable space with a certain sound depth. |

Note

The available parameters differ depending on the input sources and the settings of this unit.

STEREO

| Program | Descriptions |
|------------|--|
| 2ch Stereo | Use this program to mix down multi-channel sources to 2 channels. |
| 7ch Stereo | Use this program to output sound from all speakers. When you play back multi-channel sources, this unit downmixes the source to 2 channels, and then outputs the sound from all speakers. This program creates a larger sound field and is ideal for background music at parties, etc. |

■ **The Compressed Music Enhancer**

MUSIC ENHANCER

| Program | Descriptions |
|-------------------|--|
| Straight Enhancer | Use this program to enhance the sound nearest to the original depth and width of the 2-channel or multi-channel compression artifacts. |
| 7ch Enhancer | Use this program to play back compression artifacts in 7-channel stereo. |

■ **Surround decode mode**

SUR. DECODE

| Program | Descriptions |
|--------------|--|
| Sur. Decoder | Select this program to playback sources with selected decoders. You can playback 2-channel sources on multi-channels. See page 79 for details. |

■ Using sound field programs without surround speakers (Virtual CINEMA DSP)

Virtual CINEMA DSP allows you to enjoy the CINEMA DSP programs without surround speakers. It creates virtual speakers to reproduce the natural sound field. When you set “SUR. L/R SP” to “NONE” (see page 88), Virtual CINEMA DSP activates automatically whenever you select a sound field program (see page 48).

Note

Virtual CINEMA DSP will not activate even when “SUR. L/R SP” is set to “NONE” (see page 88) in the following cases:

- when the component connected to the MULTI CH INPUT jacks is selected as the input source (see page 43).
- when headphones are connected to the PHONES jack.
- when this unit is in the “7ch Stereo” mode.

■ Enjoying multi-channel sources and sound field programs with headphones (SILENT CINEMA)

SILENT CINEMA allows you to enjoy multi-channel music or movie sound, including Dolby Digital and DTS sources, through ordinary headphones. SILENT CINEMA activates automatically whenever you connect headphones to the PHONES jack while listening to sound field programs (see page 48). When activated, the SILENT CINEMA indicator lights up in the front panel display.

Notes

- SILENT CINEMA does not activate when the component connected to the MULTI CH INPUT jacks is selected as the input source (see page 43).
- SILENT CINEMA is not effective when the “Pure Direct” (see page 52) or “2ch Stereo” mode (see page 50) is selected, or when this unit is in the “Straight” mode (see page 51).

Before performing the following operation, set the operation mode selector on the remote control to **AMP**.

Enjoying unprocessed input sources (Straight decoding mode)

When this unit is in the “Straight” mode, 2-channel stereo sources are output from only the front left and right speakers. Multi-channel sources are decoded straight into the appropriate channels without any additional effect processing.

Press **STRAIGHT** (or **STRAIGHT**) to select “Straight”.

■ Deactivating the “Straight” mode

Press **STRAIGHT** (or **STRAIGHT**) so that “Straight” disappears from the front panel display.

The sound effect is turned back on.

Using audio features

Before performing the following operations, set the operation mode selector on the remote control to **AMP**.

Adjusting the speaker level

You can adjust the output level of each speaker while listening to a music source. This is also possible when playing sources input at the MULTI CH INPUT jacks.

Note

This operation will override the level adjustments made in “AUTO SETUP” (see page 32) and “SP LEVEL” (see page 89).

- 1 Press **LEVEL** on the remote control and then **▲ / ▼** repeatedly to select the speaker you want to adjust.

| Display | Adjusted speaker |
|---------|-----------------------------|
| FRONT L | Front left speaker |
| FRONT R | Front right speaker |
| CENTER | Center speaker |
| SUR. L | Surround left speaker |
| SUR. R | Surround right speaker |
| SBL | Surround back left speaker |
| SBR | Surround back right speaker |
| SWFR | Subwoofer |
| PRNS L | Presence left speaker |
| PRNS R | Presence right speaker |



- The available speaker channels differ depending on the setting of the speakers.
- When the video monitor is turned on, the “LEVEL” adjustment menu appears in the video monitor.

- 2 Press **◀ / ▶** to adjust the speaker output level.

- Press **▶** to increase the value.
- Press **◀** to decrease the value.

Control range: -10.0 dB to +10.0 dB

- 3 Press **LEVEL** to turn off the speaker level adjustment display.

Enjoying pure hi-fi sound

Use the Pure Direct mode to enjoy the pure high fidelity sound of the selected source. When the Pure Direct mode is activated, this unit plays back the selected source with the least circuitry.

- Press **PURE DIRECT** (or **PURE DIRECT**) to turn the Pure Direct mode on or off.

The **PURE DIRECT** button on the front panel lights up while this unit is in the Pure Direct mode. The front panel display automatically dims.

Notes

- The following operations are not possible when this unit is in the Pure Direct mode:
 - switching the sound field program
 - displaying the OSD
 - adjusting the “SET MENU” parameters (except for level settings)
 - operating video functions (video conversion, etc.)
- The Pure Direct mode is automatically canceled whenever this unit is turned off.



The front panel display turns on momentarily when an operation is performed.

Adjusting the tonal quality

Use this feature to adjust the balance of bass and treble for the front left and right speaker channels.



Speaker and headphone adjustments are stored independently.

- 1 Press **TONE CONTROL** on the front panel repeatedly to select the high-frequency response (TREBLE) or the low-frequency response (BASS).

- 2 Rotate the **PROGRAM** selector to adjust the high-frequency response (TREBLE) or the low-frequency response (BASS).

Control range: -6 dB to +6 dB

Notes

- If you increase or decrease the high-frequency or the low-frequency sound to an extreme level, the tonal quality of the surround speakers may not match.
- TONE CONTROL is not effective when PURE DIRECT is selected, or when MULTI CH INPUT is selected as the input source.

FM/AM tuning

Overview

You can use two tuning modes to tune into the desired FM/AM station:

Frequency tuning mode (AUTO TUNING/MANUAL TUNING)

You can search or specify the frequency of the desired FM/AM station automatically or manually (see “Basic tuning operations” on this page).

Preset tuning mode (PRESET TUNING)

You can preset the desired FM/AM station in advance, and then recall the station by specifying the preset group and number (see “Using station preset feature” on page 54).

Note

Orient the connected FM and AM antennas for the best reception.

Basic tuning operations

Before performing the following operations, set the operation mode selector on the remote control to **⑩SOURCE** and then press **④TUNER**.

1 Rotate the **⑧INPUT** selector (or press **④TUNER**) to select “TUNER” as the input source.

2 Press **③BAND** (or **⑦BAND**) to select the reception band.
“FM” or “AM” appears in the front panel display.

3 Press **⑨SEARCH MODE** (or **⑰SRCH MODE**) to select the desired tuning mode.

Automatic tuning mode (AUTO TUNING)

Use this feature when the signal from the station you want to select is strong.

When this unit is in the automatic tuning mode, “AUTO TUNING” appears in the front panel display for a moment. The AUTO indicator appears in the front panel display.

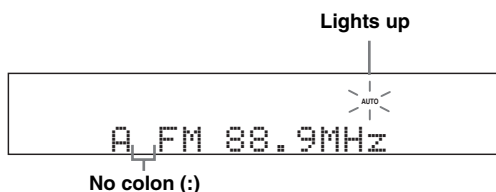

Manual tuning mode (MANUAL TUNING)

Use this feature if the signal from the station you want to select is weak and you cannot tune by using the automatic tuning. When this unit is in the manual tuning mode, “MANUAL TUNING” appears in the front panel display for a moment.

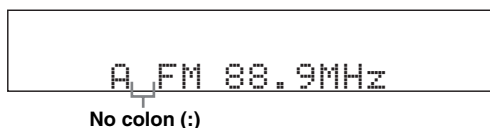

- Manually tuning into an FM station automatically switches the tuner to monaural reception to increase the signal quality.
- (U.S.A. model only)
If you tune into a hybrid HD Radio station by using the manual tuning mode, this unit automatically selects the analog radio service. You cannot select the HD Radio audio programs (see page 57) and display the HD Radio information (see page 58).

Preset tuning mode (PRESET TUNING)

Use this feature to recall the preset stations. When this unit is in the preset tuning mode, “PRESET TUNING” appears in the front panel display for a moment. Frequency tuning is not possible. See page 54 for details.

4 Press **⑤PRESET/TUNING/CH** **◀/▶** (or **⑥PRESET/CH** **▲/▼**) repeatedly to tune into the desired station.

- Press **⑤▶** (or **⑥▲**) to tune into a higher frequency.
- Press **⑤◀** (or **⑥▼**) to tune into a lower frequency.



- When this unit is tuned into a station, the TUNED indicator lights up.
- Hold down the button to continue searching when this unit is in the manual tuning mode.
- Press **Ⓢ**INFO (or **Ⓢ**INFO) repeatedly to toggle the frequency information and sound field program information in the front panel.
- (U.S.A. model only)
If the station that this unit is tuned into is an HD Radio station, you can toggle the HD Radio information in the front panel display by pressing **Ⓢ**INFO (or **Ⓢ**INFO) repeatedly. See page 58 for details.
- (U.S.A. model only)
If the station that you tune this unit into is the HD Radio station, the HD indicator also appears in the front panel display. See page 57 for details about the HD Radio features.

Before performing the following operations, set the operation mode selector on the remote control to **Ⓢ**SOURCE and then press **Ⓢ**TUNER.

■ Direct frequency tuning

Use this feature tune into the desired station directly by entering the frequency.

- 1 Press **Ⓢ**BAND on the remote control repeatedly to select the desired reception band.

“FM” or “AM” appears in the front panel display.

- 2 Press **Ⓢ**SEARCH MODE (or **Ⓢ**SRCH MODE) repeatedly to select “AUTO TUNING” or “MANUAL TUNING”.



No colon (:)



If a colon (:) appears in the front panel display, manual tuning is not possible. Press **Ⓢ**SEARCH MODE (or **Ⓢ**SRCH MODE) to turn the colon (:) off.

- 3 Enter the frequency of the desired station by pressing the numeric buttons (**Ⓢ**).

Example: To tune into 103.7 MHz



If the entered frequency is out of the range of the FM/AM tuning, “WRONG STATION!” appears in the front panel display and then this unit automatically tunes into the last selected station.

Using station preset feature

Use this feature to store up to 40 stations FM/AM stations (A1 to E8: 8 preset station numbers in each of the 5 preset station groups). Preset the desired stations to this unit by using the automatic or manual preset tuning features in advance (see “Automatic station preset” and “Manual station preset” on page 55).

Before performing the following operations, set the operation mode selector on the remote control to **Ⓢ**SOURCE and then press **Ⓢ**TUNER.

- 1 Press **Ⓢ**SEARCH MODE (or **Ⓢ**SRCH MODE) repeatedly to select “PRESET TUNING”.

- 2 Press **Ⓢ**PRESET/TUNING/CH </> (or **Ⓢ**PRESET/CH Δ / ▽) to select the desired preset station number (A1 to E8).

The preset station group and number appear in the front panel display along with the station band and frequency.

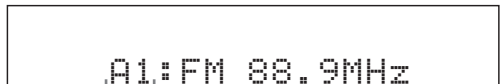

Preset group and preset station number



You can select the preset station group (A to E) by pressing **Ⓢ**A/B/C/D/E (or **Ⓢ**A-E/CAT. </>) repeatedly.

Note

- (U.S.A. model only)
When you recall one of the sub-audio program (HD2 to HD8) of an FM HD Radio station, it takes a few seconds for this unit to recall the desired program. While this unit recalls the sub-audio program, this unit outputs the sound of the analog service of the station.
- (U.S.A. model only)
If the selected sub-audio program is currently not available, this unit is tuned into the main audio program, and if the main audio program is also not available, this unit is tuned into the analog service.

■ Automatic station preset

You can use the automatic preset tuning feature to store up to 40 FM stations with strong signals (A1 to E8: 8 preset station numbers in each of the 5 preset station groups) in order.

(U.S.A. model only)

You can use the automatic preset tuning feature to store up to 40 AM HD Radio, FM HD Radio, and analog FM radio stations with strong signals.

- 1 Rotate the **INPUT** selector (or press **TUNER**) to select "TUNER" as the input source.

(U.S.A. model)

- 2 Press **BAND** (or **BAND**) to select the desired reception band.

"FM" or "AM" appears in the front panel display. This unit searches the stations in the selected band and then another band.

(Canada model)

- 2 Press **BAND** (or **BAND**) to select "FM" as the reception band.

"FM" appears in the front panel display.

- 3 Press and hold **MEMORY** (or **MEMORY**) for more than 3 seconds.

The preset station number as well as the MEMORY and AUTO indicators flashes. After approximately 5 seconds, automatic presetting starts from the current frequency and proceeds toward higher frequencies.

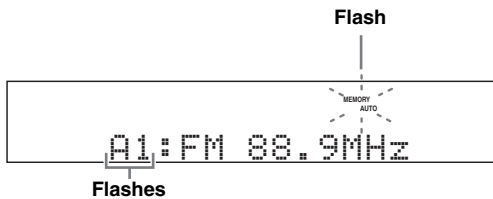

When automatic preset tuning is completed, the MEMORY indicator disappears.



- You can specify the preset number from which this unit stores FM stations. Press **A/B/C/D/E** (or **A-E/CAT.** </>) and then **PRESET/TUNING/CH** </> (or **PRESET/CH** Δ / ∇) repeatedly after you perform step 3 to select the preset station number under which the first station will be stored.
- To cancel the automatic station preset, press **MEMORY** (or **MEMORY**) again.

Notes

- (U.S.A. model only)
 - When this unit stores the FM HD Radio stations with this feature, this unit stores only the main audio program of the stations (HD1). When you want to store the sub-audio programs of the FM HD Radio stations, preset the stations manually.
- Any stored station data existing under a preset station number is cleared when you store a new station under the same preset station number.
- If the number of received stations does not reach 40 (E8), automatic preset tuning automatically stops after searching for all the available stations and copy the stored stations to the rest preset station numbers.
- (Canada model only)
 - Only FM stations with sufficient signal strength are stored automatically by automatic preset tuning. If the station you want to store is weak in signal strength or an AM radio station, tune into it manually and store it as described in "Manual station preset" below.

■ Manual station preset

Use this feature to store the AM or FM stations with weak signals manually.

(U.S.A. model only)

You can store the analog AM/FM radio stations and AM/FM HD Radio stations manually, and you can also store the sub-audio programs of FM HD Radio station.

- 1 Tune into a station.

See page 53 for tuning instructions.



(U.S.A. model only)

To store a sub-audio program of the HD Radio station (HD2 to HD8), press **PRG SELECT** <</> / >>/> repeatedly to select the desired audio program (see page 57).

- 2 Press **MEMORY** (or **MEMORY**).

The MEMORY indicator flashes in the front panel display for approximately 30 seconds.

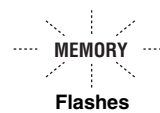

To cancel the preset memory mode, press **MEMORY** (or **MEMORY**) again.

3 Press \textcircled{E} PRESET/TUNING/CH $\triangleleft/\triangleright$ (or $\textcircled{8}$ PRESET/CH \triangle/∇) repeatedly to select a preset station group and number (A1 to E8) while the MEMORY indicator is flashing.

- Press $\textcircled{E}\triangleright$ (or $\textcircled{8}\triangle$) to select a higher preset station group and number.
- Press $\textcircled{E}\triangleleft$ (or $\textcircled{8}\nabla$) to select a lower preset station group and number.

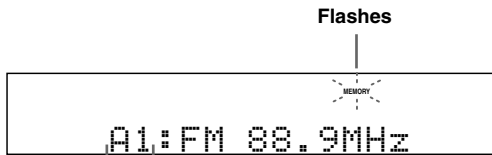

The displayed station has been stored as A1.



You can select the preset station group (A to E) by pressing $\textcircled{A/B/C/D/E}$ (or $\textcircled{8}A-E/CAT.$ $\triangleleft/\triangleright$) repeatedly.

4 Press \textcircled{F} MEMORY (or $\textcircled{9}$ MEMORY) while the MEMORY indicator is flashing.

The station band and frequency appear in the front panel display with the preset station group and number you have selected. The MEMORY indicator disappears from the front panel display.

Notes

- Any stored station data existing under a preset station number is cleared when you store a new station under the same preset station number.
- The reception mode (stereo or monaural) is stored along with the station frequency.

■ Exchanging preset stations

You can exchange the assignments of two preset stations with each other. The example below describes the procedure to exchange preset station “E1” with “A5”.

Before performing the following operations, set the operation mode selector on the remote control to $\textcircled{16}$ SOURCE and then press $\textcircled{4}$ TUNER.

1 Select preset station “E1” using $\textcircled{A/B/C/D/E}$ and \textcircled{E} PRESET/TUNING/CH $\triangleleft/\triangleright$.

See “Using station preset feature” on page 54.

2 Press and hold \textcircled{B} EDIT for more than 3 seconds.

“E1” and the MEMORY indicator flash in the front panel display.

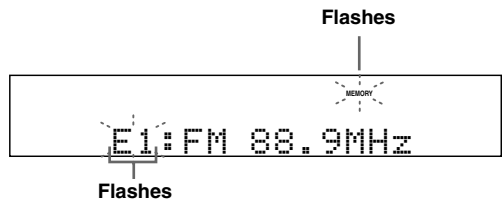

3 Select preset station “A5” using $\textcircled{A/B/C/D/E}$ and \textcircled{E} PRESET/TUNING/CH $\triangleleft/\triangleright$.

“A5” and the MEMORY indicator flash in the front panel display. See “Using station preset feature” on page 54.

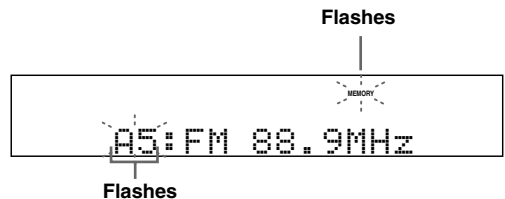

4 Press \textcircled{B} EDIT again.

“EXCHANGE E1-A5” appears in the front panel display and the assignments of the two preset stations are exchanged.

Using HD Radio™ features (U.S.A. model only)

HD Radio technology is a new technology that enables FM and AM radio stations to broadcast programs digitally. Digital broadcasting provides listeners with radically improved audio quality and reception as well as new data services. Furthermore, supplemental program services allow listeners to select from up to 8 HD Radio programs multicast on a single FM HD Radio channel. For further information on HD Radio technology, visit “<http://www.ibiguity.com/>”. This unit is equipped with an HD Radio reception feature, facilitating CD quality FM broadcasts as well as analog FM stereo quality AM broadcasts. In addition, this unit can receive both audio and data (such as song titles, artist names, program types, and comments) from supplemental program services (HD1 to HD8).

☼
When the HD Radio signals include the audio signal flag data (“Neural”, etc.), the flag information appears in the “SIGNAL INFO” screen (see page 46). We recommend that you select “SUR. DECODE” as the sound field program and activate the surround decoder corresponding to the flag information (see page 80).

Notes

- The tuning method for HD Radio stations are same as analog FM/AM radio stations; however, if you tune into a hybrid HD Radio station by using the manual tuning mode, this unit automatically selects the analog radio service. Use the automatic tuning mode, preset tuning mode, or direct frequency tuning to tune into the desired HD Radio station (see pages 53 and 54).
- This unit is capable of receiving both hybrid and all-digital HD Radio station signals. However, this unit may not automatically receive all-digital FM station signals and the automatic tuning operation may stop. In this case, enter the frequency of the desired all-digital FM HD Radio station directly by using the numeric buttons (Ⓢ) (see page 54).

Before performing the following operations, set the operation mode selector on the remote control to Ⓢ SOURCE and then press Ⓣ TUNER.

Selecting HD Radio™ audio programs

Use this feature to select one of the 8 HD Radio audio programs (HD1 to HD8) when the unit is in the tuner mode. Each audio program contains data programs. When the selected FM HD Radio station provides some audio programs, currently selected audio program number appears in the front panel display as follows.

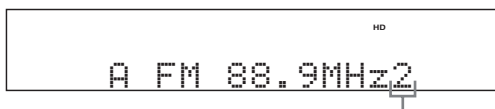

Currently selected audio program

Press Ⓢ PRG SELECT ◀◀ / ▶▶ on the remote control repeatedly to toggle between HD Radio audio programs.

The HD indicator may disappear from the front panel display while toggling between data programs.

☼
You can also select the desired HD Radio audio program by pressing the numeric key. While this unit is in the automatic or manual tuning mode, press a numeric button (1-8) (Ⓢ) and then Ⓢ ENT.

Notes

- Only 1 HD Radio audio program (HD1) is available for AM broadcasts, while up to 8 audio programs (HD1 to HD8) are available for FM broadcasts. The audio programs from HD2 to HD8 can be selected only when they contain data programs.
- When reception for an audio program ceases, the HD indicator disappears from the front panel display and HD1 is automatically selected after approximately 20 seconds.
- Some audio programs may not contain data programs depending on the broadcasting station and the time period.

Displaying HD Radio™ information

Use this feature to display the HD Radio information in the front panel display or video monitor.

■ Front panel display

Press **Ⓢ** **INFO** (or **Ⓢ** **INFO**) repeatedly to toggle between the following HD Radio information displays.

| | |
|---|---------------------|
| STATION INFO 1 | e.g.) A FM 88.9MHz2 |
| Preset station group and number/Frequency/Audio program (only when multiple audio programs are available) | |



| | |
|--|---------------------|
| STATION INFO 2 | e.g.) WXYZ-FM <2/3> |
| Station name/Audio program (only when multiple audio programs are available) | |



| | |
|------------------|--------------------|
| CATEGORY INFO | e.g.) Classic Rock |
| Program category | |



| | |
|------------------------|----------------------|
| SONG INFO | e.g.) Frankie Zipper |
| Artist name/Song title | |



| | |
|-------------|---------------------|
| ALBUM INFO | e.g.) Made-to-order |
| Album title | |



| | |
|-------------------------|--------------------|
| ANTENNA INFO | e.g.) ANTENNA ■■■- |
| Antenna reception level | |



| | |
|---------------------|-----------------------|
| DSP PROG. INFO | e.g.) The Bottom Line |
| Sound field program | |



Back to "STATION INFO 1"



- You can set the front panel display mode by using "FL SCROLL" in "DISPLAY SET" (see page 98).
- Press **Ⓢ** **ENTER** repeatedly to hold and release the current HD Radio information. While this unit is holding the information, the HOLD indicator flashes in the front panel display.

■ Video monitor

Press **Ⓢ** **DISPLAY** on the remote control.

The following information is displayed in the video monitor.

| | | | |
|-----|-------------------|------------------|-----|
| | TUNER Information | ANT:■■■ | [5] |
| | | | [6] |
| [1] | A1:FM 88.9MHz2 | PRESET | |
| | | WXYZ-FM HD <2/3> | [7] |
| [2] | ♣:Classic Rock | | |
| | A:Frankie Zipper | | [8] |
| [3] | ♪:Road to India | | |
| [4] | Ⓢ:Made-to-order | | |

[1] Preset station Category and number/frequency/Audio program (only when multiple audio programs are available)

[2] Program category

[3] Song title

[4] Album title

[5] Antenna reception level

[6] Tuning mode (see page 53)

[7] Station name/Audio program (only when multiple audio programs are available)

[8] Artist name



- To turn off the displayed information screen, press **Ⓢ** **DISPLAY** again.
- Press **Ⓢ** **ENTER** repeatedly to hold and release the current HD Radio information. While this unit is holding the information, the "HOLD" appears in the OSD.
- You can set the time for which the HD Radio information is displayed in the video monitor by using the "OSD-SOURCE" parameter in "Manual Setup" (see page 98).
- The current HD Radio reception level appears on the top of the HD Radio information screen. For the best reception, adjust the orientation of the antenna so that "■■■" or "■■■■" is displayed here.
- When this unit is tuned into an analog FM/AM radio station, "TUNER Information" appears as follows.

| | | |
|--|-------------------|---------|
| | TUNER Information | ANT:■■■ |
| | A1:FM 98.7MHz | PRESET |
| | | ANALOG |
| | ♣:_____ | |
| | A:_____ | |
| | ♪:_____ | |
| | Ⓢ:_____ | |

XM Satellite Radio tuning

XM Radio offers an extraordinary variety of commercial-free music, plus the best in premier sports, news, talk radio, stand-up comedy, children's and entertainment programming. XM is broadcast in superior digital audio quality from coast to coast. From rock to reggae, from classical to hip hop, XM has something for every music fan.

XM Satellite Radio online information

For U.S. customers: <http://www.xmradio.com/>

For Canadian customers: <http://www.xmradio.ca/>

Note

The XM Satellite Radio service is only available in the 48 contiguous United States (not available in Alaska and Hawaii) and Canada.

XM READY legal disclaimer

XM monthly service subscription sold separately. XM Mini-Tuner and Home Dock required (each sold separately) to receive XM service. It is prohibited to copy, decompile, disassemble, reverse engineer, hack, manipulate or otherwise make available any technology or software incorporated in receivers compatible with the XM Satellite Radio System. Installation costs and other fees and taxes, including a one-time activation fee may apply. All fees and programming subject to change. Channels with frequent explicit language are indicated with an XL. Channel blocking is available for XM radio receivers by calling 1-800-XM-RADIO (US residents) and 1-877-GET-XMSR (Canadian residents). For a full listing of the XM commercial-free channels and advertising-supported channels, visit lineup.xmradio.com (US residents) or xmradio.ca (Canadian residents). Subscriptions subject to Customer Agreement available at www.xmradio.com (US residents) and www.xmradio.ca (Canadian residents). Only available in the 48 contiguous United States and Canada. ©2008 XM Satellite Radio Inc. All rights reserved. All other trademarks are the property of their respective owners.

■ Enjoying XM HD Surround content

This unit is equipped with the Neural Surround decoder that plays back the XM HD surround sound content of the XM Satellite Radio broadcasts in multi-channels, resulting in a full surround sound experience (see page 80).

Connecting the XM Mini-Tuner Dock

Connect the XM Mini-Tuner and the XM Dock (sold separately) to the XM jack on the rear panel of this unit. For details, see the operating instructions provided with the XM Mini-Tuner Dock.

XM Mini-Tuner and XM Dock
(sold separately)

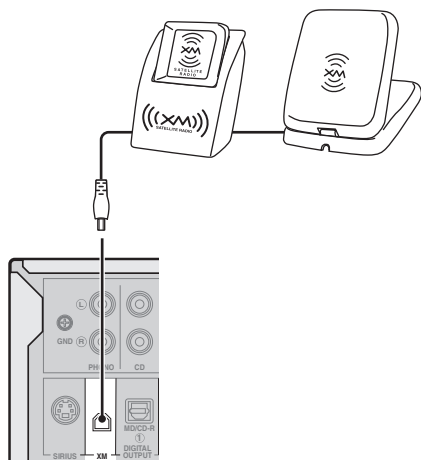

To ensure optimal reception of the XM Satellite Radio signals, the XM Mini-Tuner Dock must be placed at or near a southerly facing window with no obstacles in the path to the sky. You can mount it indoors or outdoors. Use the "ANTENNA INFO" information in the front panel or "XM Information" screen in the video monitor (see page 63) to check the antenna reception level and adjust the orientation of the antenna.

Note

If "CHECK ANTENNA" or "CHECK XM TUNER" appears in the front panel display, the connection and setting of the antenna, Home Dock, or XM Mini-Tuner may not correct (see page 117).

Activating XM Satellite Radio

Once you have installed the XM Mini-Tuner Dock, inserted the XM Mini-Tuner, connected the XM Dock to your XM Ready® home audio system, and installed the antenna, you are ready to subscribe and begin receiving XM programming. There are three places to find your eight character XM Radio ID: On the XM Mini-Tuner, on the XM Mini-Tuner package, and on XM Channel 0. Record the XM Radio ID in the following eight squares for reference.



Note

The XM Radio ID does not use the letters “I”, “O”, “S” or “F”. Activate your XM Satellite Radio service in the U.S. online at <http://activate.xmradio.com/> or call 1-800-XM-RADIO (1-800-967-2346). Activate your XM Satellite Radio service in Canada online at <https://activate.xmradio.ca/> or call 1-877-GET-XMSR (1-877-438-9677). You will need a major credit card. XM will send a signal from the satellites to activate the full channel lineup. Activation normally takes 10 to 15 minutes, but during peak busy periods you may need to keep your XM Ready home audio system on for up to an hour. When you can access the full lineup on your XM Ready home audio system you are done.

Basic XM Satellite Radio operations

Before performing the following operations, set the operation mode selector on the remote control to **SOURCE**.

1 Rotate the **INPUT** selector (or press **XM**) to select “XM” as the input source.

The cursor on the left of the XM indicator lights up in the front panel display and the XM Satellite Radio information (such as channel number, channel name, category, artist name, or song title) for the currently selected channel appears in the front panel display.

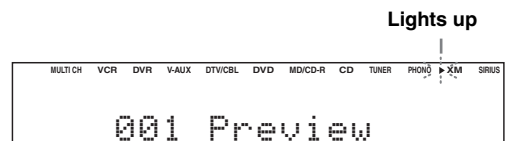

When you select “XM” as the input source, this unit automatically recalls the previously selected channel.

Notes

- The XM Satellite Radio signals cannot be output at the AUDIO OUT (REC) jacks.
- If a status message or an error message appears in the front panel display or in the OSD, see the “XM Satellite Radio” section in “Troubleshooting” on page 113 for appropriate remedies.

2 Search for a channel by using one of the XM Satellite Radio search modes.

- To select a channel from the all channel list, see “All Channel Search mode” on page 61.
- To select a channel by category, see “Category Search mode” on page 61.
- To select a channel from the preset channels, see “Preset Search mode” on page 61.
- To select the desired channel directly by entering the channel number, see “Direct number access mode” on page 61.



- You can use the Neural Surround decoder to enjoy the XM HD surround sound content of the XM Satellite Radio broadcasts in multi-channels (see page 80).
- You can set the XM Satellite Radio preset channels (see page 62).
- You can display the XM Satellite Radio information in the front panel display or in the OSD (see page 63).

Before performing the following operations, set the operation mode selector on the remote control to **⑩SOURCE** and then press **④XM**.

■ All Channel Search mode

1 Press **⑥SEARCH MODE (or **⑩SRCH MODE**) repeatedly to select “ALL CH SEARCH”.**

2 Press **⑥PRESET/TUNING/CH </> (or **⑧PRESET/CH** Δ / ∇) repeatedly to search for a channel within all channels.**

- ☀️
- You can search for a channel quickly by pressing and holding **⑥PRESET/TUNING/CH** </> (or **⑧PRESET/CH** Δ / ∇).
- To display the XM Radio ID number displayed in the front panel display, select channel “0”.

■ Category Search mode

1 Press **⑥SEARCH MODE (or **⑩SRCH MODE**) repeatedly to select “CAT SEARCH”.**

2 Press **⑩CATEGORY (or **⑧A-E/CAT.** </>) repeatedly to change the channel category.**

3 Press **⑥PRESET/TUNING/CH </> (or **⑧PRESET/CH** Δ / ∇) repeatedly to search for a channel within the selected channel category.**

- ☀️
- You can search for a channel quickly by pressing and holding **⑥PRESET/TUNING/CH** </> (or **⑧PRESET/CH** Δ / ∇).

■ Preset Search mode

Prior to selecting a preset channel in the Preset Search mode, you must preset XM Satellite Radio channels. For details, see “Setting the XM Satellite Radio preset channels” on page 62.

- ☀️
- The initial factory setting of all preset channels (A1 to E8) is “001 Preview”.

1 Press **⑥SEARCH MODE (or **⑩SRCH MODE**) repeatedly to select “PRESET SEARCH”.**

2 Press **⑩CATEGORY (or **⑧A-E/CAT.** </>) repeatedly to change the preset channel group (A to E).**

3 Press **⑥PRESET/TUNING/CH </> (or **⑧PRESET/CH** Δ / ∇) repeatedly to change the preset channel number (1 to 8).**

- ☀️
- You can also select the preset channel number directly by pressing the numeric buttons (1 to 8) (**⑥**).

■ Direct number access mode

1 Press **⑩SRCH MODE on the remote control repeatedly to select “ALL CH SEARCH” or “CAT SEARCH”.**

2 Press the numeric buttons (⑥**) to enter the desired three-digit channel number.**
For example, to enter the number 123, press the numeric buttons (**⑥**) as shown below.



- ☀️
- To enter a one-digit or two-digit channel number, press the numeric buttons (**⑥**) on the remote control and then press **⑩ENT** to confirm the input number.
- Instead of pressing **⑩ENT** to tune into the channel immediately, you can wait a few seconds until this unit confirms the entered channel number.
- Pressing a button other than the numeric buttons (**⑥**) or **⑩ENT** cancels the Direct Number Access mode procedure.

Before performing the following operations, set the operation mode selector on the remote control to **ⓅSOURCE** and then press **ⓄXM**.

Setting the XM Satellite Radio preset channels

You can use this feature to store up to 40 XM Satellite Radio channels (A1 to E8: 8 preset channel numbers in each of the 5 preset channel groups). You can then recall any preset channel easily by selecting the preset channel group and number as described in “Preset Search mode” on page 61.

1 Search for a channel you want to set as a preset channel by using one of the XM Satellite Radio search modes.

See “Basic XM Satellite Radio operations” on page 60 for details.



Currently selected channel number

2 Press **ⓄMEMORY** (or **ⓄMEMORY**).

The MEMORY indicator flashes in the front panel display for approximately 30 seconds.



Flashes

Note

You must proceed to and carry out steps 3 through 4 while the MEMORY indicator is flashing in the front panel display.

3 Press **ⓄPRESET/TUNING/CH** **</>** (or **ⓄPRESET/CH** **Δ/∇**) repeatedly to select a preset channel group and number (A1 to E8) while the MEMORY indicator is flashing.

The preset channel number appears in the front panel display.

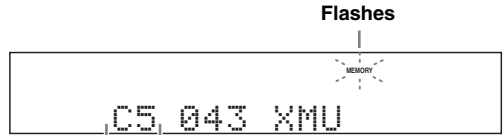

Selected preset channel group and number



You can select the preset station group (A to E) by pressing **ⓄA/B/C/D/E** (or **ⓄA-E/CAT**. **</>**) repeatedly.

4 Press **ⓄMEMORY** (or **ⓄMEMORY**) to set the selected XM Satellite Radio channel as a preset channel while the MEMORY indicator is flashing.

A colon (:) appears next to the preset channel number for confirmation, and the MEMORY indicator turns off in the front panel display.

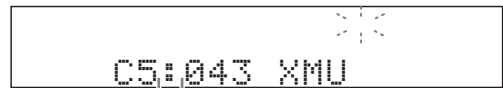

Colon (:)

Note

Once you set a new preset channel, the one previously stored in the same preset channel group and number is cleared.

Before performing the following operations, set the operation mode selector on the remote control to **SOURCE** and then press **XM**.

Displaying the XM Satellite Radio information

You can display the XM Satellite Radio information (such as channel number, channel name, category, artist name, or song title) for the currently selected channel in the front panel display or in the OSD.

Note

If a status message or an error message appears in the front panel display or in the OSD, see the “XM Satellite Radio” section in “Troubleshooting” on page 113 for appropriate remedies.

■ Displaying the XM Satellite Radio information in the front panel display

Press **INFO** (or **INFO**) repeatedly to toggle between the following XM Satellite Radio information display modes.

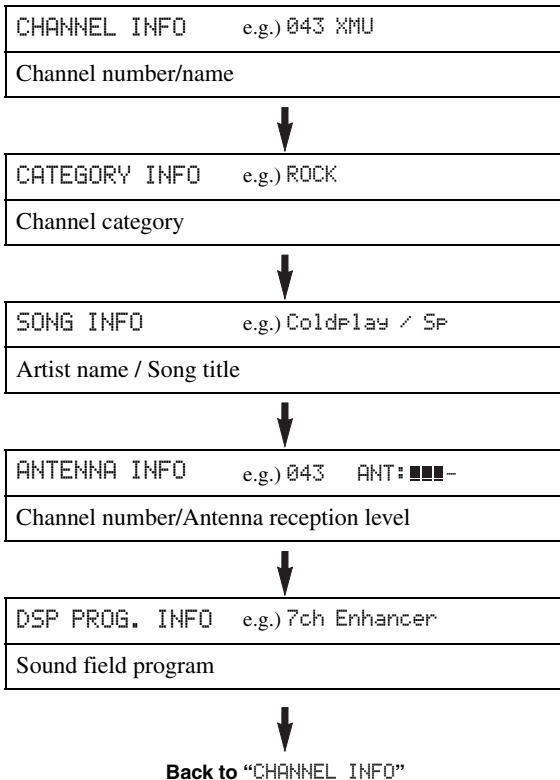

- The front panel display can indicate up to 14 alphanumeric characters at once. You can set whether to display the XM Satellite Radio information in the front panel display in a continuous manner or by 14 alphanumeric characters at once by using the “FL SCROLL” parameter in “OPTION MENU” (see page 98).
- If the XM Satellite Radio information contains a character that cannot be recognized by this unit, the character will be displayed with a space.
- To hold the current XM Radio information, press **ENTER** on the remote control while it is being displayed. The HOLD indicator flashes in the front panel display while you are holding the XM information. Press **ENTER** again to release the held information.
- When the antenna of the XM Mini-Tuner Dock cannot receive the signals, “NO SIGNAL” appears in the front panel display.

■ Displaying the XM Satellite Radio information in the OSD

Press **DISPLAY**.

The following screen is displayed in the OSD.

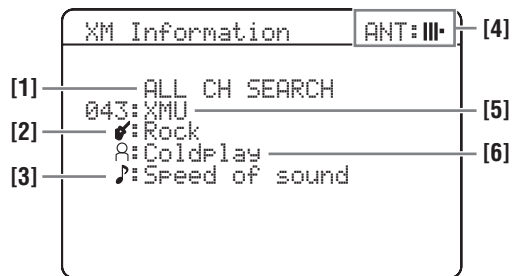

- [1] Search mode (see page 60)
- [2] Channel category
- [3] Song title
- [4] Antenna reception level
- [5] Channel number/name
- [6] Artist name



- To turn off the OSD, press **DISPLAY** again.
- XM status messages also appear in the OSD.
- You can select the amount of time the XM Satellite Radio information is displayed in the OSD by using the “OSD-SOURCE” parameter in “OPTION MENU” (see page 98).
- To hold the XM Satellite Radio information, press **ENTER** on the remote control while it is being displayed in the OSD. “HOLD” appears in the screen while you are holding the XM information. Press **ENTER** again or change the XM Satellite Radio channel to release the held information.
- The current XM Satellite Radio reception level appears on the top of the XM Satellite Radio information screen. For the best reception, adjust the orientation of the antenna of Home Dock so that “■■■” or “■■■■” is displayed here. “...” is displayed if the antenna cannot receive the signals correctly. In this case, adjust the orientation of the antenna (see page 59).

SIRIUS Satellite Radio™ tuning

SIRIUS Satellite Radio provides over 130 channels of exclusive entertainment and 100% commercial-free music. Only SIRIUS has more than 65 original music channels, from today's hits to R&B, oldies, and classical masterpieces. From authentic country and real bluegrass to cool jazz, hot latin, reggae, rock and many more. Best of all, it's all 100% commercial-free.

SIRIUS also has more than 55 channels of world-class sports, news and entertainment. Included as part of your subscription, you get up to 16 NFL games a week, up to 40 NBA games a week and up to 40 NHL games a week. (Games are broadcast during their respective seasons.)

Coupled with great sports news from ESPN, the SIRIUS sports offering is unrivaled. And don't forget a host of other great news and entertainment, like NPR, CNBC, Fox News, Radio Disney and E! Entertainment Radio. For more information, visit <http://www.sirius.com/>.

SIRIUS Satellite Radio legal disclaimer

SIRIUS is available in the U.S.A. for subscribers with addresses in the continental U.S.A. and is available in Canada for subscribers with a Canadian address. To Get SIRIUS Satellite Radio a subscription and compatible tuner and antenna are required and sold separately. Visit sirius.com for the most complete and up-to-date channel lineup and information.

"SIRIUS" and the SIRIUS dog logo and related marks are trademarks of SIRIUS Satellite Radio Inc.

Connecting the SiriusConnect™ tuner

Connect the SiriusConnect tuner (sold separately) to the SIRIUS jack on the rear panel of this unit. For details, see the operating instructions provided with the SiriusConnect tuner.

SiriusConnect™ tuner and the antenna
(sold separately)

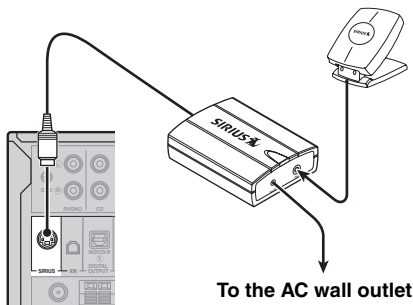

- To ensure optimal reception of the SIRIUS Satellite Radio signals, the antenna of the SiriusConnect tuner must be placed at or near a window with no obstacles in the path to the sky. The orientation of the antenna for the best reception differs depending on the area. Refer to the instruction manuals supplied with the SiriusConnect tuner for the installation of the antenna. You can mount it indoors or outdoors.
- Use the "ANTENNA INFO" information in the front panel or "SIRIUS Information" screen in the video monitor (see page 69) to check the antenna reception level and adjust the orientation of the antenna.
- You need to connect the SiriusConnect tuner to the AC wall outlet.

Notes

- If "CHECK SR TUNER" or "ANTENNA ERROR" appears in the front panel display, the connection of the SiriusConnect tuner or antenna is incorrect. In such cases, check the connection of the SiriusConnect tuner and the antenna (see page 118).
- If "NOT SUPPORTED" appears in the front panel display, this unit does not support the connected SiriusConnect tuner.

Activating SIRIUS Satellite Radio™ subscription

Before using the SIRIUS Satellite Radio feature, you need to activate your SIRIUS Satellite Radio subscription. To activate the subscription you need the Sirius ID which is uniquely assigned to the SiriusConnect tuner. Sirius ID is 12-digit number and it appears on the package of the SiriusConnect tuner, on the label of the SiriusConnect tuner, and when you tune into the SIRIUS Satellite Radio channel “0” (see below).

■ Displaying the Sirius ID of your SiriusConnect tuner

1 Set the operation mode selector on the remote control to **ⓂSOURCE** and then press **ⓄSIRIUS**.

2 Press **Ⓞ0** and then **ⓂENT** to display the Sirius ID of your SiriusConnect tuner.

“000 Sirius IDxxxxxxxxxx” (“xxxxxxxxxx” indicates the 12-digit Sirius ID of your SiriusConnect tuner) appears in the front panel display.



To scroll the message again, press **ⓄINFO** (or **ⓂINFO**).

Write the Sirius ID below.

ID: _____

3 Contact SIRIUS Satellite Radio to activate your subscription.

SIRIUS Satellite Radio online information

Contact for activation

URL: <https://activate.siriusradio.com/>

Phone: 1-888-539-SIRIUS (1-888-539-7474)



Status messages appear in the front panel display or video monitor during the activation. For details, see “SIRIUS Satellite Radio” section on page 118. Once the activation is finished, “SUB UPDATED” appears.

Basic SIRIUS Satellite Radio™ operations

Before performing the following operations, set the operation mode selector on the remote control to **ⓂSOURCE**.

1 Rotate the **ⓂINPUT** selector (or press **ⓄSIRIUS**) to select “SIRIUS” as the input source.

The cursor on the left of the SIRIUS indicator lights up in the front panel display and the SIRIUS Satellite Radio information (such as channel number, channel name, category, artist name, or song title) for the currently selected channel appears in the front panel display.

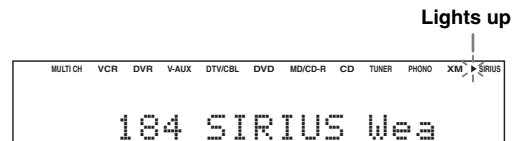

When you select “SIRIUS” as the input source, this unit automatically recalls the previously selected channel.

Notes

- The SIRIUS Satellite Radio signals cannot be output at the AUDIO OUT (REC) jacks.
- When you have not activated your subscription yet, you can only select “184” or “000”.
- If a status message or an error message appears in the front panel display or in the OSD, see the “SIRIUS Satellite Radio” section in “Troubleshooting” on page 118 for appropriate remedies.

2 Search for a channel by using one of the SIRIUS Satellite Radio search modes.

- To select a channel from the all channel list, see “All Channel Search mode” on page 66.
- To select a channel by category, see “Category Search mode” on page 66.
- To select a channel from the preset channels, see “Preset Search mode” on page 66.
- To select the desired channel directly by entering the channel number, see “Direct number access mode” on page 66.



- If you tune into a channel that you do not subscribe, “CALL 888-539-SIRIUS TO SUBSCRIBE” appears in the front panel display. To scroll the message again, press **ⓄINFO** (or **ⓂINFO**).
- You can set the SIRIUS Satellite Radio preset channels (see page 67).
- You can display the SIRIUS Satellite Radio information in the front panel display or in the video monitor (see page 69).

Before performing the following operations, set the operation mode selector on the remote control to **ⓅSOURCE** and then press **ⓄSIRIUS**.

■ All Channel Search mode

- 1 Press **ⓅSEARCH MODE** (or **ⓇSRCH MODE**) repeatedly to select “ALL CH SEARCH”.
- 2 Press **ⓈPRESET/TUNING/CH** $\triangleleft/\triangleright$ (or **ⓈPRESET/CH** \triangle/∇) repeatedly to search for a channel within all channels.



- You can search for a channel quickly by pressing and holding **ⓈPRESET/TUNING/CH** $\triangleleft/\triangleright$ (or **ⓈPRESET/CH** \triangle/∇).
- You can skip channels to the previous or next category by pressing **ⓈCATEGORY** (or **ⓈA-E/CAT.** $\triangleleft/\triangleright$).

■ Category Search mode

- 1 Press **ⓅSEARCH MODE** (or **ⓇSRCH MODE**) repeatedly to select “CAT SEARCH”.
- 2 Press **ⓈCATEGORY** (or **ⓈA-E/CAT.** $\triangleleft/\triangleright$) repeatedly to change the channel category.
- 3 Press **ⓈPRESET/TUNING/CH** $\triangleleft/\triangleright$ (or **ⓈPRESET/CH** \triangle/∇) repeatedly to search for a channel within the selected channel category.



You can search for a channel quickly by pressing and holding **ⓈPRESET/TUNING/CH** $\triangleleft/\triangleright$ (or **ⓈPRESET/CH** \triangle/∇).

Note

This unit skips the channels when this unit is All Channel Search mode or Category Search mode in the following cases (it is not malfunction of this unit):

- the channel is locked (see page 67).
- the channel is out of service.
- you do not subscribe to the channel.

■ Preset Search mode

Prior to selecting a preset channel in the Preset Search mode, you must preset SIRIUS channels. For details, see “Setting the SIRIUS Satellite Radio™ preset channels” on page 67.

- 1 Press **ⓅSEARCH MODE** (or **ⓇSRCH MODE**) repeatedly to select “PRESET SEARCH”.
- 2 Press **ⓈCATEGORY** (or **ⓈA-E/CAT.** $\triangleleft/\triangleright$) repeatedly to change the preset channel group (A to E).
- 3 Press **ⓈPRESET/TUNING/CH** $\triangleleft/\triangleright$ (or **ⓈPRESET/CH** \triangle/∇) repeatedly to change the preset channel number (1 to 8).



You can also select the preset channel number directly by pressing the numeric buttons (1 to 8) (**Ⓢ**).

■ Direct number access mode

- 1 Press **ⓇSRCH MODE** on the remote control repeatedly to select “ALL CH SEARCH” or “CAT SEARCH”.
- 2 Press the numeric buttons (**Ⓢ**) to enter the desired three-digit channel number.
For example, to enter the number 123, press the numeric buttons (**Ⓢ**) as shown below.



- To display the Sirius ID number displayed in the front panel display, select channel “0”.
- To enter a one-digit or two-digit channel number, press the numeric buttons (**Ⓢ**) on the remote control and then press **ⓈENT** to confirm the input number.
- Instead of pressing **ⓈENT** to tune into the channel immediately, you can wait a few seconds until this unit confirms the entered channel number.
- If no button is pressed within a few seconds after you enter a one-digit or two-digit number, this unit automatically confirms the entered channel number.
- If the selected channel is locked, “PIN:___” appears in the front panel display. Enter the four-digit Parental Lock code number by using the numeric buttons (**Ⓢ**) or press **ⓈENT** to cancel (see page 67).

Before performing the following operations, set the operation mode selector on the remote control to **16 SOURCE** and then press **4 SIRIUS**.

Setting the SIRIUS Satellite Radio™ preset channels

You can use this feature to store up to 40 SIRIUS Satellite Radio channels (A1 to E8: 8 preset channel numbers in each of the 5 preset channel groups). You can then recall any preset channel easily by selecting the preset channel group and number as described in “Preset Search mode” on page 66.

1 Search for a channel you want to set as a preset channel by using one of the SIRIUS Satellite Radio search modes.

See “Basic SIRIUS Satellite Radio™ operations” on page 65 for details.



Currently selected channel number

2 Press **5 MEMORY** (or **6 MEMORY**).

The MEMORY indicator flashes in the front panel display for approximately 30 seconds.

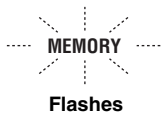

Note

You must proceed to and carry out steps 3 through 4 while the MEMORY indicator is flashing in the front panel display.

3 Press **7 PRESET/TUNING/CH** $\triangleleft/\triangleright$ (or **8 PRESET/CH** \triangle/∇) repeatedly to select a preset channel group and number (A1 to E8) while the MEMORY indicator is flashing.

The preset channel number appears in the front panel display.

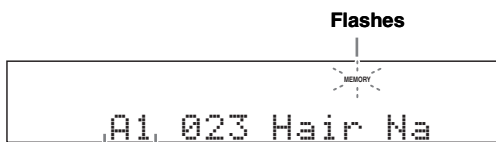

Currently selected preset channel group and number



You can select the preset station group (A to E) by pressing **7 A/B/C/D/E** (or **8 A-E/CAT**, $\triangleleft/\triangleright$) repeatedly.

4 Press **5 MEMORY** (or **6 MEMORY**) to set the selected SIRIUS Satellite Radio channel as a preset channel while the MEMORY indicator is flashing.

A colon (:) appears next to the preset channel number for confirmation, and the MEMORY indicator turns off in the front panel display.

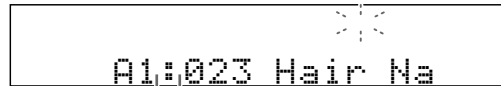

Colon (:)

Note

Once you set a new preset channel, the one previously stored in the same preset channel group and number is cleared.

Setting the Parental Lock

You can use the Parental Lock feature to limit the access to the desired SIRIUS Satellite channels. This unit automatically skips the locked channels when this unit is in the All Channel Search mode or Category Search mode and you search a channel by pressing **7 PRESET/TUNING/CH** $\triangleleft/\triangleright$ (or **8 PRESET/CH** \triangle/∇).

■ Setting the code number and the locked channels

Use this feature to set the Parental Lock code number (PIN) and select the channels to be locked.

1 Set the operation mode selector to **16 AMP** on the remote control and then press **19 SET MENU** to display.

2 Press **8** ∇ to select “MANUAL SETUP” and then press **8 ENTER**.

3 Press **8** ∇ repeatedly to select “INPUT MENU” and then press **8 ENTER**.

4 Press $\textcircled{8}$ Δ / ∇ repeatedly to select “SIRIUS” and then press $\textcircled{8}$ ENTER.

The following menu screen appears.

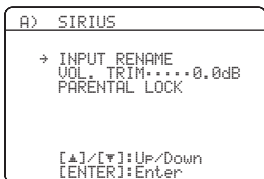

5 Press $\textcircled{8}$ ∇ repeatedly to select “PARENTAL LOCK” and then press $\textcircled{8}$ ENTER.

“NEW PIN:0000” appears.

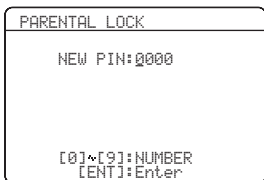

Note

If a SiriusConnect tuner is not connected to this unit, “Not Available” appears.



If the Parental Lock code number is already set, “PIN:___” appears instead of “NEW PIN:0000”. Refer to step 8 and then proceed the operations.

6 Enter the desired 4-digit code number by using the numeric buttons ($\textcircled{6}$).



Press $\textcircled{9}$ RETURN to return the previous menu level without setting the code number.

7 Press $\textcircled{8}$ ENTER to confirm the code number.

“OK” and then the SIRIUS Satellite Radio channel list appears. Refer to the step 9 and then proceed the operations.

8 Enter the 4-digit code number you set at step 6 above to unlock the protection.

When the code number is correct, “OK” and then the SIRIUS Satellite Radio channel list appears.

9 Press $\textcircled{8}$ \triangleleft / \triangleright repeatedly to select the desired channel category and then press $\textcircled{8}$ Δ / ∇ repeatedly to select the channel you want to lock.

Note

In the SIRIUS Satellite Radio channel list screen, this unit outputs the sound of the selected channel even if the channel is locked. Only the first eight characters of each channel name are displayed in the list.

10 Press $\textcircled{8}$ ENTER to lock the selected channel.

Check mark appears before the locked channel.



When you select the locked channel and press $\textcircled{8}$ ENTER, this unit unlocks the selected channel.

11 Repeat steps 9 and 10 to lock the channels you want.

12 Press $\textcircled{9}$ RETURN to exit from the “PARENTAL LOCK” screen.

13 Press $\textcircled{19}$ SET MENU to exit from the setup menu.

This unit is tuned into the last channel you select in the “PARENTAL LOCK” screen. If the channel is locked, this unit is tuned into “184 SIRIUS Weather & Emergency” or “000 Sirius IDxxxxxxxxxxxx” (“xxxxxxxxxxxx” indicates the Sirius ID of your SiriusConnect tuner).



- If you forget or want to change the Parental lock code number, use “SR PIN” in “ADVANCED SETUP” to reset the Parental Lock code number.
- When you select “ALL” in “INIT” (see page 112), all locked channels are unlocked.

■ Tuning into the locked channels

You can tune into the locked channels by the Direct number access mode or preset tuning mode. When you tune into the locked channel, following message appears in the front panel display. Enter the code number you set for the Parental Lock feature by using the numeric buttons ($\textcircled{6}$) or press $\textcircled{18}$ ENT to cancel the tuning.

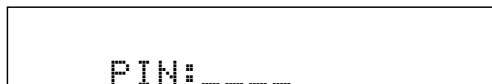

Notes

- If the entered code number is incorrect, “Wrong” appears in the front panel display and this unit is tuned into the previously selected channel.
- If a channel is unlocked, you can also select the channel in Zone2.

Before performing the following operations, set the operation mode selector on the remote control to **SOURCE** and then press **SIRIUS**.

Displaying the SIRIUS Satellite Radio™ information

You can display the SIRIUS Satellite Radio information (such as channel number, channel name, category, artist name, composer name, or song title) for the currently selected channel in the front panel display or in the OSD.

Note

If a status message or an error message appears in the front panel display or in the OSD, see the “SIRIUS Satellite Radio” section in “Troubleshooting” on page 118 for appropriate remedies.

■ Displaying the SIRIUS Satellite Radio information in the front panel display

Press **INFO** (or **INFO**) repeatedly to toggle between the following SIRIUS Satellite Radio information display modes.

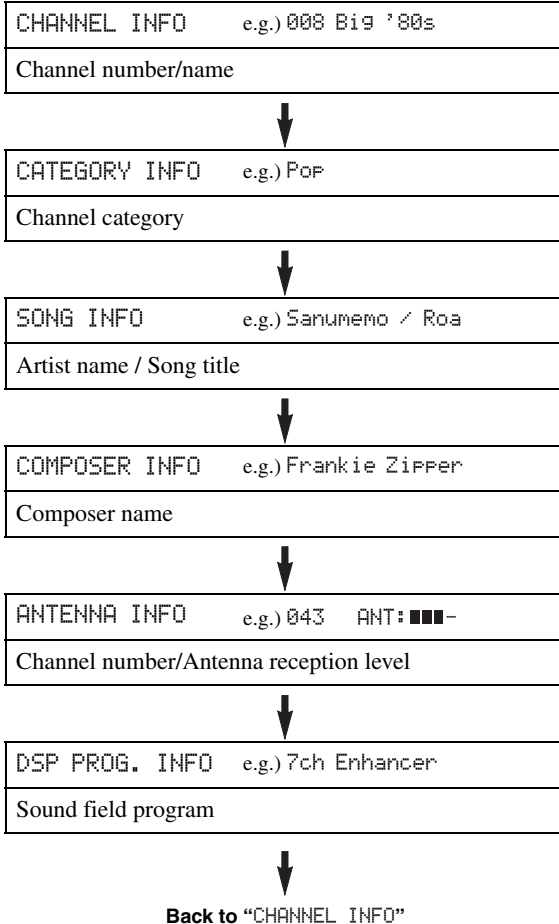

- The front panel display can indicate up to 14 alphanumeric characters at once. You can set whether to display the SIRIUS Satellite Radio information in the front panel display in a continuous manner or by 14 alphanumeric characters at once by using the “FL SCROLL” parameter in “OPTION MENU” (see page 98).
- If the SIRIUS Satellite Radio information contains a character that cannot be recognized by this unit, the character will be displayed with a space.
- To hold the current SIRIUS Satellite Radio information, press **ENTER** on the remote control while it is being displayed. Press **ENTER** again to release the held information.
- When the antenna of the SiriusConnect tuner cannot receive the signals, “ACQUIRING” appears in the front panel display.
- When an information is unavailable, “----” appears.

■ Displaying the SIRIUS Satellite Radio information in the OSD

Press **DISPLAY** on the remote control.

The following screen is displayed in the OSD.

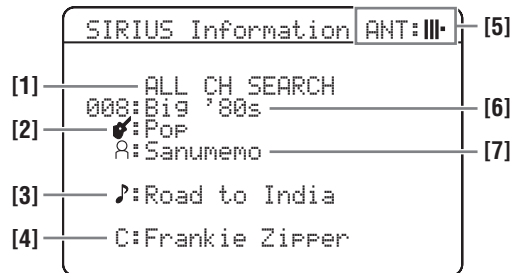

[1] Search mode (see page 65)

[2] Channel category

[3] Song title

[4] Composer name

[5] Antenna reception level

[6] Channel number/name

[7] Artist name



- To turn off the OSD, press **DISPLAY** again.
- SIRIUS status messages also appear in the OSD.
- You can select the amount of time the SIRIUS Satellite Radio information is displayed in the OSD by using the “OSD-SOURCE” parameter in “OPTION MENU” (see page 98).
- To hold the SIRIUS Satellite Radio information, press **ENTER** on the remote control while it is being displayed in the OSD. While this unit is holding the information screen, “HOLD” appears in the OSD.
- The HOLD indicator flashes in the front panel display while you are holding the SIRIUS information. Press **ENTER** again or change the SIRIUS Satellite Radio channel to release the held information.

Using iPod™

Once you have stationed your iPod in a Yamaha iPod universal dock (such as YDS-10, sold separately) connected to the DOCK terminal of this unit (see page 25), you can enjoy playback of your iPod using the supplied remote control. You can also use the Compressed Music Enhancer mode of this unit to improve the sound quality of the compression artifacts (such as the MP3 format) stored on your iPod (see page 50).

Notes

- Only iPod (Click and Wheel), iPod nano, and iPod mini are supported.
- Some features may not be compatible depending on the model or the software version of your iPod.



- For a complete list of status messages that appear in the front panel display and in the OSD, see the “iPod” section in “Troubleshooting” on page 119.
- Once the connection between your iPod and this unit is complete, “iPod connected” appears in the front panel display and the DOCK indicator lights up in the front panel display.
- Only the analog audio and video signals of your iPod are input at the DOCK terminal, and the analog audio signals can be output at the analog AUDIO OUT (REC) jacks for recording.
- Your iPod battery is automatically charged when your iPod is stationed in a Yamaha iPod universal dock connected to the DOCK terminal of this unit as long as this unit is turned on. You can also select whether this unit charges the battery of the stationed iPod or not when this unit is in the standby mode by selecting the “STANDBY CHARGE” parameter in “INPUT MENU” (see page 96). The DOCK indicator turns on while this unit charges the battery of the connected iPod when this unit is in the standby mode.

Controlling iPod™

You can control your iPod when “V-AUX” is selected as the input source. The operations of your iPod can be done with the aid of the OSD of this unit (menu browse mode) or without it (simple remote mode).

■ Remote control operation

Before performing the following operations, set the operation mode selector on the remote control to **⑯SOURCE** and then press **④V-AUX**.

| Button | Function |
|------------------|---|
| ⑧ ENTER | Subsequent menu |
| △ | Menu up |
| ▽ | Menu down |
| ◀ | Previous menu |
| ▶ | Subsequent menu |
| ⑩ ◀◀ | Search backward (Press and hold) |
| ▶▶ | Search forward (Press and hold) |
| ▶▶▶ | Skip forward |
| ◀◀◀ | Skip backward |
| □ | Stop |
| ⏸ | Pause (Menu browse mode) Play/Pause (Simple remote mode) |
| ▶ | Play (Menu browse mode) Play/Pause (Simple remote mode) |
| ⑰ MENU | Previous menu |
| ⑳ DISPLAY | Display |

■ Controlling iPod in the simple remote mode

You can perform the basic operations of your iPod (play, stop, skip, etc.) using the supplied remote control without the aid of the OSD of this unit.



- You can view the photos or video clips stored on your iPod (some models only).
- Operations can be also done with the controls on your iPod.

■ Controlling iPod in the menu browse mode

You can perform the advanced operations of your iPod using the supplied remote control with the aid of the OSD of this unit. You can browse the songs stored on your iPod in the OSD. Further, you can change or adjust settings for your iPod to suit your personal preferences.



- The name of the song being played also appears in the front panel display according to the “FL SCROLL” parameter in “OPTION MENU” (see page 98).
- You can select the amount of time the iPod menu and play information is displayed in the OSD by using the “OSD-SOURCE” in “OPTION MENU” (see page 98).

Notes

- Operations cannot be done with the controls on your iPod.
- There are some characters that cannot be displayed in the front panel display or in the OSD of this unit. Those characters are replaced with underscores “_”.
- The “Settings” parameters can be changed or adjusted only in the OSD. Press **ENTER** or **Δ/∇** repeatedly on the remote control to toggle between the “Settings” parameter settings.
- You cannot browse the photos or video clips stored on your iPod in the OSD. Use the simple remote mode to enjoy watching the photos or video clips stored on your iPod.

1 Set the operation mode selector to **SOURCE** and then press **DISPLAY** on the remote control.

The following display appears in the OSD.



2 Press **Δ/∇/◀/▶** to navigate the iPod menu and then press **ENTER** to begin playback of the selected song.

Choices: Playlists (playlists), Artists (artists), Albums (albums), Songs (songs), Genres (genres), Composers (composers), Settings (settings)

- Playlists > Songs
- Artists > Albums > Songs
- Albums > Songs
- Songs
- Genres > Artists > Albums > Songs
- Composers > Albums > Songs
- Settings > Shuffle, Repeat

Shuffle Shuffle

Use this feature to set this unit to play songs or albums in random order.

Choices: Off, Songs, Albums

- Select “Off” to deactivate this feature.
- Select “Songs” to set this unit to play songs in random order.
- Select “Albums” to set this unit to play albums in random order.



When “Shuffle” is set to a setting other than “Off”, “” appears in the top right corner while songs or albums are being shuffled.

Repeat Repeat

Use this feature to set this unit to repeat one song or a sequence of songs.

Choices: Off, One, All

- Select “Off” to deactivate this feature.
- Select “One” to set this unit to repeat one song.
- Select “All” to set this unit to repeat a sequence of songs.



When “Repeat” is set to a setting other than “Off”, “” or “” appears in the top right corner while one song or a sequence of songs are being repeated.

■ The function of the play information display

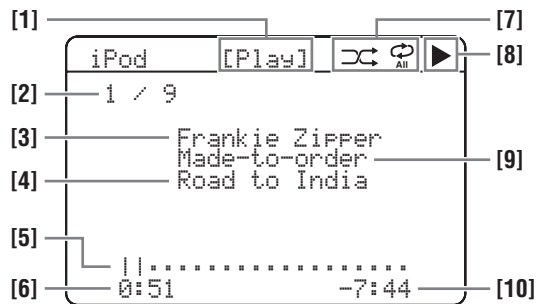

- [1] Playback status
- [2] Track number/total tracks
- [3] Artist name
- [4] Song title
- [5] Progress bar
- [6] Elapsed time
- [7] Shuffle and repeat icons
- [8] (playback), (pausing), (search forward) and (search backward)
- [9] Name of the album
- [10] Remaining time

Using Bluetooth™ components

You can connect a Yamaha Bluetooth adapter (such as YBA-10, sold separately) to the DOCK terminal of this unit and enjoy the music contents stored in your Bluetooth component (such as a portable music player) without wiring between this unit and the Bluetooth component. You need to perform “pairing” the connected Bluetooth adapter and your Bluetooth component in advance.

Pairing the Bluetooth™ adapter and your Bluetooth component

Pairing must be performed when using a Bluetooth component with the Bluetooth adapter connected to this unit for the first time or if the pairing data has been deleted. “Pairing” refers to the operation of registering a Bluetooth component for Bluetooth communications.



- You only need the pairing operation for the first time that you use the Bluetooth component with the Bluetooth adapter.
- Pairing requires operations on this unit and on the other component with which Bluetooth communications are to be established. If necessary, refer to the other component’s operating instructions.

There are two pairing methods: pairing by using “START PAIRING” in “SET MENU” and quick pairing.

■ Pairing by using “SET MENU”

Use this feature to perform pairing with the video monitor. Select “START PAIRING” in “INPUT MENU”. See page 97 for details.

■ Quick pairing

To ensure security, a time limit of 8 minutes is set for the pairing operation. You are recommended to read and fully understand all the instructions before starting.

1 Rotate the **ⓇINPUT selector (or set the operation mode selector to **Ⓢ**SOURCE and then press **Ⓞ**V-AUX) to select “V-AUX” as the input source.**

2 Turn on the Bluetooth component you want to pair with.

3 Press and hold **ⓈBAND (or **Ⓡ**BAND) for 3 seconds to start pairing.**

Once the Bluetooth adapter starts pairing, “Searching...” appears for a moment. While the Bluetooth adapter is in the pairing mode, DOCK indicator flashes in the front panel display.



To cancel the pairing, press **Ⓢ**BAND (or **Ⓡ**BAND) again.

Note

If the Bluetooth adapter is not connected to the DOCK terminal of this unit, “No BT adapter” appears in the front panel display.

4 Check that the Bluetooth component detects the Bluetooth adapter.

If the Bluetooth component detects the Bluetooth adapter, “YBA-10 YAMAHA” (example) appears in the Bluetooth device list.

5 Select the Bluetooth adapter in the Bluetooth device list and then enter the pass key “0000” on the Bluetooth component.

When the pairing procedure is successful, “Completed” appears in the front panel display.

Note

The Yamaha Bluetooth adapter can be paired with up to eight Bluetooth components. When pairing is conducted successfully with a ninth component and the pairing data is registered, the pairing data for the least recently used other component is cleared.

Playback of the Bluetooth™ component

1 Rotate the **ⓇINPUT selector (or set the operation mode selector to **Ⓢ**SOURCE and then press **Ⓞ**V-AUX) to select “V-AUX” as the input source.**

2 Start playback of your Bluetooth component.

When the connected Bluetooth adapter detects the Bluetooth component, “BT connected” and the DOCK indicator appears in the front panel display.



- When you press **Ⓢ**ENTER on the remote control, the connected Bluetooth adapter searches and connect to the last connected Bluetooth component. If the Bluetooth adapter cannot find the Bluetooth component, “Not found” appears in the front panel display.
- To disconnect the Bluetooth adapter from the Bluetooth component, press **Ⓢ**RETURN.

Recording

Recording adjustments and other operations are performed from the recording components. Refer to the operating instructions for those components.

Caution

The DTS signal is a digital bitstream. Attempting to digitally record the DTS bitstream will result in noise being recorded. Therefore, if you want to use this unit to record sources encoded in DTS, the following considerations and adjustments need to be made. To play DTS-encoded DVDs and CDs (when using a digital audio connection) on your DTS-compatible player, follow its operating instructions to make a setting so that the analog signal will be output from the player.

Notes

- When this unit is set to the standby mode, you cannot record between other components connected to this unit.
- TONE CONTROL (see page 52) and VOLUME settings, the speaker level (see page 52) and the sound field programs (see page 48) do not affect recorded material.
- The source connected to the MULTI CH INPUT jacks of this unit cannot be recorded.
- The XM Satellite Radio and SIRIUS Satellite Radio signals cannot be output at the AUDIO OUT (REC) jacks.
- HD Radio signals can be output at the analog AUDIO OUT (REC) jacks and DIGITAL OUTPUT jack for recording.
- Digital signals input at the DIGITAL INPUT jacks are not output at the analog AUDIO OUT (REC) jacks for recording. Likewise, analog signals input at the AUDIO IN jacks are not output at the DIGITAL OUTPUT jack. Therefore, if your source component is connected to provide only digital or analog signals, you can only record digital or analog signals.
- A given input source is not output on the same AUDIO OUT (REC) channel.
- S-video and composite video signals pass independently through the video circuits of this unit. Therefore, when recording or dubbing video signals input from a video source component that provides only an S-video or a composite video signal, you can only record an S-video or a composite video signal on your VCR.
- The analog audio signals input at the DOCK terminal can be output at the analog AUDIO OUT (REC) jacks for recording.
- Check the copyright laws in your country to record from CDs, radio, etc. Recording of copyrighted material may infringe copyright laws.



Do a test recording before you start an actual recording.

If you play back a video source that uses scrambled or encoded signals to prevent it from being dubbed, the picture itself may be disturbed due to those signals.

1 Turn on all the connected components.

2 Rotate the **ⒷINPUT selector (or press one of the input selector buttons (**④**)) to select the source component you want to record from.**

3 Start playback on the selected source component or select a broadcast station.

4 Start recording on the recording component.

Advanced sound configurations

Changing sound field parameter settings

You can enjoy good quality sound with the initial factory settings. Although you do not have to change the initial factory settings, you can change some of the parameters to better suit the input source or your listening room.

Note

You cannot change the sound field parameter values when "MEMORY GUARD" in "OPTION MENU" is set to "ON" (see page 100). If you want to change the sound field parameter values, set "MEMORY GUARD" to "OFF".

1 Turn on the video monitor connected to this unit.

2 Set the operation mode selector to **AMP and then press **PARAMETER** on the remote control.**

The following screen is shown in the OSD.

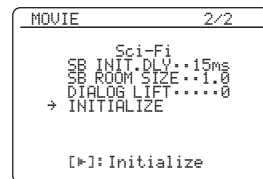
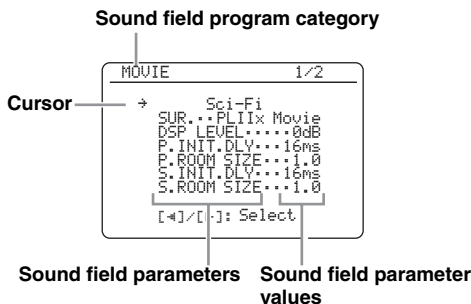

3 Press **PROG </> repeatedly to select the desired sound field program you want to adjust.**

4 Press **Δ / **∇** to select the desired sound field parameter and then **◀** / **▶** to change the selected sound field parameter value.**

- Press **▶** to increase the value.
- Press **◀** to decrease the value.



- For details about the function and control range of each sound field parameter, see page 76.
- When you set a sound field parameter to a value other than the initial factory settings, an asterisk mark (*) appears by the sound field parameter name in the OSD.
- Repeat steps 3 and 4 as necessary to change other sound field program parameter settings.
- The available sound field parameters for some of the sound field programs may be displayed on more than one page in the OSD. In this case, press **Δ** / **∇** to scroll through pages.
- To initialize the parameters of the selected sound field program, press **∇** repeatedly to select "INITIALIZE" and then press **▶**. Once the confirmation screen appears in the OSD, press **▶** to confirm or **◀** to cancel the initialization.

5 Press **PARAMETER to turn off the sound field parameter screen.**

■ Basic configuration of sound field programs

Each sound field program has some parameters defining the characteristics of the program. To customize the selected sound field program, adjust “DSP LEVEL” and/or “DIALG.LIFT” first, and then try other parameters.



To change sound field parameter settings, see page 74 for details.

Adjusting the effect sound level of the sound field programs (DSP LEVEL)

Sound field programs add effect sounds (DSP effect sounds) to the original source sound to create sound field in the listening room. Use the “DSP LEVEL” parameter to adjust the level of the effect sounds.

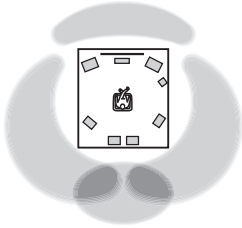

The DSP effect sound level is low.

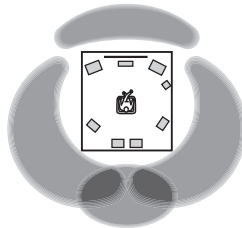

The DSP effect sound level is high.

Adjust “DSP LEVEL” in the following cases:

Increase the value of “DSP LEVEL”

- The effect sound of the selected sound field program is too weak.
- You cannot recognize any difference between the sound field programs.

Decrease the value of “DSP LEVEL”

- The sound is vague.
- You feel that the additional sound effect is excessive.

Control range: -6 dB to +3 dB

Adjusting the vertical dialogue position (DIALG.LIFT)

Use this feature to adjust the vertical position of the dialogues in movies. The ideal position of the dialogues is at the center of the video monitor screen.

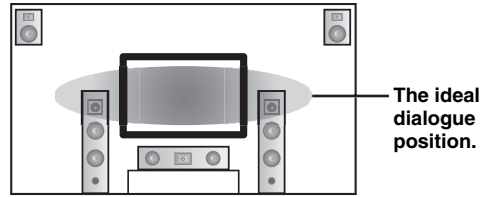

If the dialogues are heard at the lower position of the video monitor screen, increase the value of “DIALG.LIFT”.

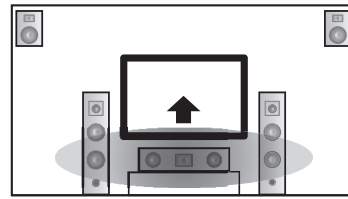

Move up to the ideal dialogue position.

Choices: 0, 1, 2, 3, 4, 5

“0” (initial setting) is the lowest position, and “5” is the highest position.

Notes

- “DIALG.LIFT” is only available only “EXTRA SP ASSIGN” is set to “PRESENCE” (see page 72).
- You cannot move the dialogue position down from the initial dialogue position.

■ Sound field parameters for the advanced configurations

Use the following sound field parameters to customize sound field programs in detail.



To change sound field parameter settings, see page 74 for details.

| Sound field parameter | Features |
|--|---|
| INIT.DLY P. INIT.DLY S. INIT.DLY SB INI.DLY | <p>Initial delay. Presence, surround, and surround back sound field initial delay. Changes the apparent distance from the source sound by adjusting the delay between the direct sound and the first reflection heard by the listener. The smaller the value, the closer the sound source seems to the reflection face.</p> <p> When you adjust the initial delay parameters, we also recommend that you adjust the corresponding room size parameters likewise. This adjustment is especially effective for the CINEMA DSP programs.</p> <hr/> <p>Control range: 1 to 99 ms (INIT.DLY and P.INIT.DLY) 1 to 49 ms (S.INIT.DLY and SB INI.DLY)</p> |

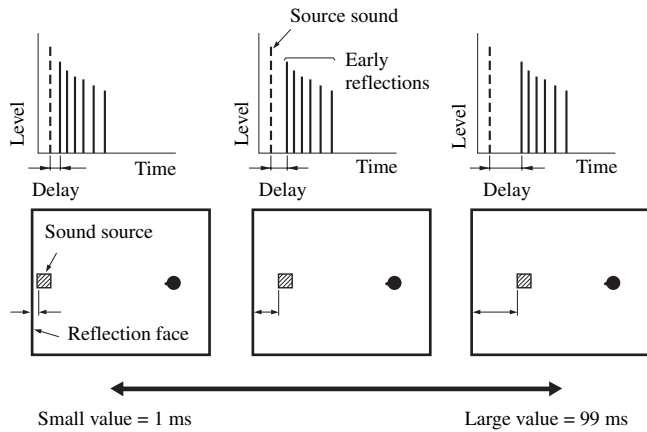

| Sound field parameter | Features |
|-----------------------|----------|
|-----------------------|----------|

ROOM SIZE
 P.ROOM SIZE
 S.ROOM SIZE
 SB ROOM SIZE

Room size. Presence, surround, and surround back room size. Adjusts the apparent size of the surround sound field. The larger the value, the larger the surround sound field becomes. As the sound is repeatedly reflected around a room, the larger the hall is, the longer the time between the original reflected sound and the subsequent reflections. By controlling the time between the reflected sounds, you can change the apparent size of the virtual venue. Changing this parameter from one to two doubles the apparent length of the room.



When you adjust the room size parameters, we also recommend that you adjust the corresponding initial delay parameters likewise. This adjustment is especially effective for the CINEMA DSP programs.

Control range: 0.1 to 2.0

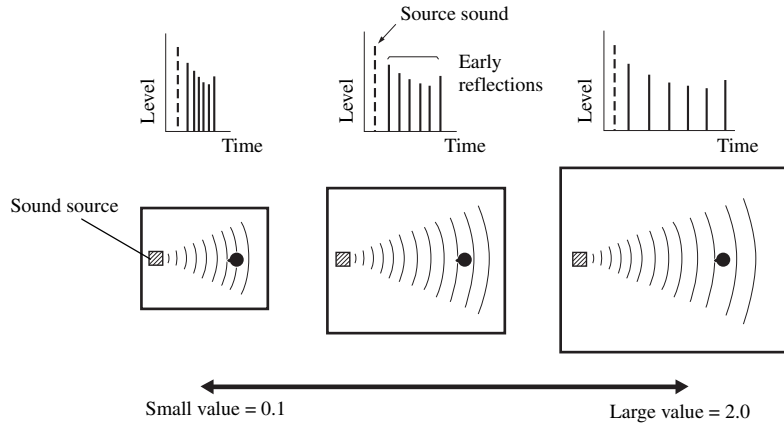

LIVENESS
 S.LIVENESS
 SB LIVENESS

Liveness. Surround and surround back sound field liveness. Adjusts the reflectivity of the virtual walls in the hall by changing the rate at which the early reflections decay. The early reflections of a sound source decay much faster in a room with acoustically absorbent wall surfaces than in one which has highly reflective surfaces. A room with acoustically absorbent surfaces is referred to as “dead”, while a room with highly reflective surfaces is referred to as “live”. This parameter lets you adjust the early reflection decay rate and thus the “liveness” of the room.

Control range: 0 to 10

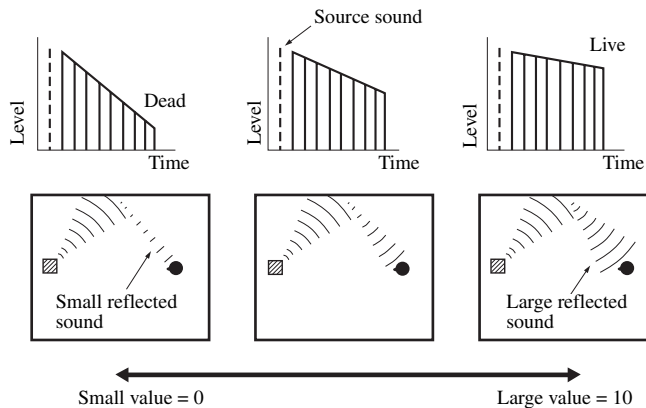

| Sound field parameter | Features |
|-----------------------|----------|
|-----------------------|----------|

REV.TIME

Reverberation time. Adjusts the amount of time taken for the dense, subsequent reverberation sound to decay by 60 dB at 1 kHz. This changes the apparent size of the acoustic environment over an extremely wide range. Set a longer reverberation time for “dead” sources and listening room environments, and a shorter time for “live” sources and listening room environments.

Control range: 1.0 to 5.0 s

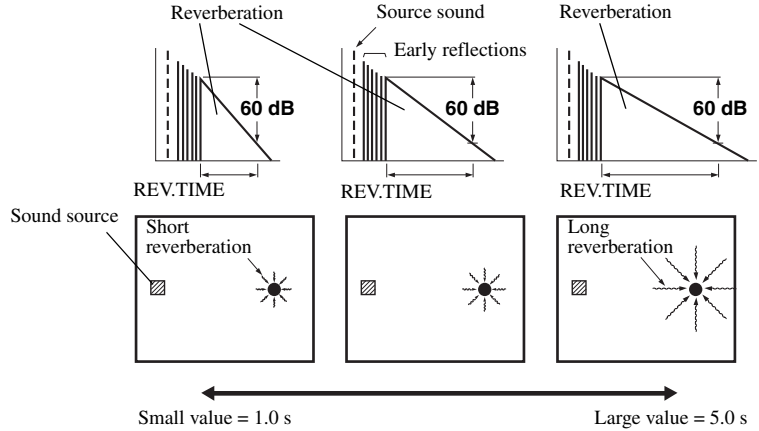

REV.DELAY

Reverberation delay. Adjusts the time difference between the beginning of the direct sound and the beginning of the reverberation sound. The larger the value, the later the reverberation sound begins. A later reverberation sound makes you feel as if you are in a larger acoustic environment.

Control range: 0 to 250 ms

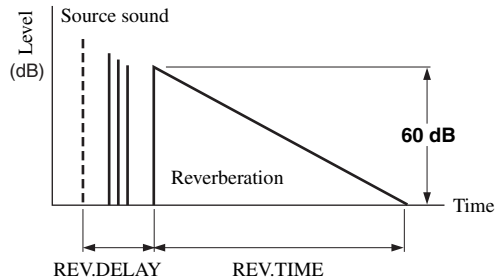

REV.LEVEL

Reverberation level. Adjusts the volume of the reverberation sound. The larger the value, the stronger the reverberation becomes.

Control range: 0 to 100%

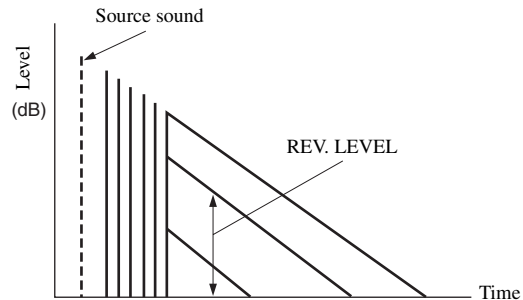

| Sound field parameter | Features |
|---|---|
| DIRECT ("2ch Stereo" only) | <p>2-channel stereo direct. Bypasses the decoders and the DSP processors of this unit for pure hi-fi stereo sound when playing 2-channel analog sources.</p> <hr/> <p>Choices: AUTO, OFF</p> <hr/> <p></p> <ul style="list-style-type: none"> • Select "AUTO" to bypass the decoders, the DSP processors and the tone control circuitry only when "BASS" and "TREBLE" are set to 0 dB (see page 52). • Select "OFF" not to bypass the decoders, the DSP processors and the tone control circuitry when "BASS" and "TREBLE" are set to 0 dB. • When multi-channel signals (Dolby Digital and DTS) are input, they are downmixed to 2 channels and output from the front left and right speakers. • The low-frequency signals of the front left and right channels are redirected to the subwoofer in the following cases: <ul style="list-style-type: none"> – "LFE/BASS OUT" is set to "BOTH" (see page 87). – "FRONT SP" is set to "SMALL" (see page 88) and "LFE/BASS OUT" is set to "SWFR" (see page 87). |
| CT LEVEL SL LEVEL SR LEVEL SB LEVEL PL LEVEL PR LEVEL ("7ch Stereo" only) | <p>7-channel stereo center, surround left, surround right, surround back, presence left and presence right levels. Adjusts the volume level of each channel in the 7-channel stereo mode. The available parameters differ depending on the setting of the speakers.</p> <hr/> <p>Control range: 0 to 100%</p> |
| EFFECT LEVEL ("Straight Enhancer" and "7ch Enhancer" only) | <p>Straight and 7-channel Compressed Music Enhancer effect level. The high-frequency signals of some sources may be emphasized too much. In this case, set the effect level to "LOW".</p> <hr/> <p>Choices: HIGH, LOW</p> <hr/> <ul style="list-style-type: none"> • Select "HIGH" for a high effect level. • Select "LOW" for a low effect level. |

■ Selecting decoders used with sound field programs (SUR.)

Use this feature to select the desired decoder used with MOVIE sound field programs (except "Mono Movie"). See page 49 for details about MOVIE sound field program.



Available decoders

| Decoder | Functions |
|---------------------------|--|
| PLIIx Movie PLII Movie | Dolby Pro Logic IIx (or Dolby Pro Logic II) processing for movie sources. The Pro Logic IIx decoder is not available when "SUR.B L/R SP" is set to "NONE" (see page 88). |
| Neo:6 Cinema | DTS processing for movie sources. |

Selecting decoders





■ Selecting decoders for 2-channel sources (surround decode mode)

Use this feature to play back sources with selected decoders. You can play back 2-channel sources on multi-channels.

Set the operation mode selector to  AMP and then press  SUR. DECODE repeatedly on the remote control to select the desired surround decoder.

You can select from the following modes depending on the type of source you are playing and your personal preference.



You can change the decoder parameter settings (see page 81). Set the operation mode to  AMP and then press  PARAMETER to display the decoder parameters in the OSD. Press  repeatedly to select the desired decoder parameter and then press  repeatedly to change the value of the selected parameter.

■ Decoder descriptions (SUR.)

| Decoder | Descriptions |
|--|---|
| Pro Logic | Dolby Pro Logic processing for any sources. |
| PLIIx Movie PLII Movie | Dolby Pro Logic IIx (or Dolby Pro Logic II) processing for movie sources. The Pro Logic IIx decoder is not available when "SUR.B L/R SP" is set to "NONE" (see page 88). |
| PLIIx Music PLII Music | Dolby Pro Logic IIx (or Dolby Pro Logic II) processing for music sources. The Pro Logic IIx decoder is not available when "SUR.B L/R SP" is set to "NONE" (see page 88). |
| PLIIx Game PLII Game | Dolby Pro Logic IIx (or Dolby Pro Logic II) processing for game sources. The Pro Logic IIx decoder is not available when "SUR.B L/R SP" is set to "NONE" (see page 88). |
| Neo:6 Cinema | DTS processing for movie sources. |
| Neo:6 Music | DTS processing for music sources. |
| CSII Cinema (U.S.A. model only) | SRS Circle Surround II processing for movie sources. |
| CSII Music (U.S.A. model only) | SRS Circle Surround II processing for music sources. |
| Neural Sur. (U.S.A. and Canada models only) | Neural Surround processing for any sources. The Neural Surround decoder is compatible with PCM signals and analog 2-channel input sources. When Neural Surround-incompatible signals are being input while the Neural Surround decoder is selected, multi-channel sources are decoded straight into the appropriate channels without any additional effect processing and the Neural Surround-incompatible PCM signals are played back in stereo. The Neural Surround decoder is especially suitable for the XM HD Surround program of XM Satellite Radio. |



When you select the surround decode mode for Dolby Digital, DTS or DTS 96/24 sources, this unit automatically selects "SURROUND DECODE Dolby Digital", "SURROUND DECODE DTS" or "SURROUND DECODE DTS 96/24" program.

Decoder parameter descriptions

| Decoder parameter | Features |
|---|--|
| PANORAMA ("PLIIX Music" and "PLII Music" only) | Pro Logic IIX Music and Pro Logic II Music panorama. Sends stereo signals to the surround speakers as well as the front speakers for a wraparound effect. Choices: OFF , ON |
| DIMENSION ("PLIIX Music" and "PLII Music" only) | Pro Logic IIX Music and Pro Logic II Music dimension. Adjusts the sound field either towards the front or towards the rear. Control range: -3 (towards the rear) to +3 (towards the front) Initial setting: STD (standard) |
| CENTER WIDTH ("PLIIX Music" and "PLII Music" only) | Pro Logic IIX Music and Pro Logic II Music center width. Moves the center channel output completely towards the center speaker or towards the front left and right speakers. A larger value moves the center channel output towards the front left and right speakers. Control range: 0 (center channel sound is output only from the center speaker) to 7 (center channel sound is output only from the front left and right speakers) Initial setting: 3 |
| C. IMAGE ("Neo:6 Music" only) | DTS Neo:6 Music center image. Adjusts the front left and right channel output relative to the center channel to make the center channel more or less dominant as necessary. Control range: 0.0 (center channel sound is output only from the front left and right speakers) to 1.0 (center channel sound output only from the center speaker) Initial setting: 0.3 |
| FOCUS ("CSII Movie" and "CSII Music" only) | SRS CSII Movie and SRS CSII Music focus. Adjusts the clearness of a sound image by elevating the perception of the sound image to compensate for non-optimally placed speakers from a lower location. A larger value makes speakers sound as if they are positioned at ear level. Control range: 0 (lower location) to 8 (higher location) |
| TruBass ("CSII Movie" and "CSII Music" only) | SRS CSII Movie and CSII Music TruBass. Adjusts the lower register by producing the perception of improved low frequency performance. A larger value improves bass even without a subwoofer and provides deeper, richer bass in the presence of a subwoofer. Control range: 0 (standard low-frequency performance) to 8 (enhanced low-frequency performance) |

Customizing this unit (MANUAL SETUP)

You can use the following parameters in “SET MENU” to adjust a variety of system settings and customize the way this unit operates. Change the initial settings (indicated in bold under each parameter) to reflect the needs of your listening environment.

■ Auto setup AUTO SETUP

Use this feature to automatically adjust speaker and system parameters (see page 32).

■ Manual setup MANUAL SETUP

Use this feature to manually adjust speaker and system parameters.

Basic menu 1 BASIC MENU

| Menu | Parameter | Functions | Page |
|----------------|---|--|------|
| A) SPEAKER SET | EXTRA SP ASSIGN | Selects the function of the speakers connected to the EXTRA SP speaker terminal. | 87 |
| | LFE/BASS OUT | Selects the speakers that output the LFE (low-frequency effect) and the low-frequency signals. | 87 |
| | FRONT SP | Selects the size of the front speakers. | 88 |
| | CENTER SP | Selects the size of the center speaker. | 88 |
| | SUR. L/R SP | Selects the size and number of the surround speakers. | 88 |
| | SUR. B L/R SP | Selects the size and number of the surround back speakers. | 88 |
| | CROSS OVER | Selects the crossover frequency of all the speakers set to “SML” (or “SMALL”) in “SPEAKER SET” (see page 88). | 89 |
| | SUBWOOFER PHASE | Switches the phase of your subwoofer if bass sounds are lacking or unclear. | 89 |
| B) SP LEVEL | FR. L/FR. R/CNTR/ SUR. L/SUR. R/ SBL/SBR/SWFR/ PR. L/PR. R | Adjust the balance the speaker levels between the front left or surround left speakers and each speaker selected in “SPEAKER SET” (see page 87). | 89 |
| C) SP DISTANCE | UNIT | Selects the unit to adjust the speaker distance. | 90 |
| | FRONT L/FRONT R/ CENTER/SUR. L/ SUR. R/SBL/SBR/ SWFR/PRNS L/ PRNS R | Adjust the distance of each speaker and the delay applied to the respective channel. | 90 |
| D) TEST TONE | — | Turns the test tone output on or off for the “SPEAKER SET”, “SP LEVEL”, and “SP DISTANCE” settings. | 90 |

Volume menu 2 VOLUME MENU

| Parameter | Functions | Page |
|--------------------|---|------|
| ADAPTIVE DRC | Selects whether this unit automatically adjusts the dynamic range in conjunction with the volume level or not. | 91 |
| ADAPTIVE DSP LEVEL | Selects whether this unit adjusts the DSP effect level automatically in conjunction with the volume level or not. | 91 |
| MUTE TYPE | Adjusts how much the mute function reduces the output volume (see page 45). | 91 |
| MAX VOL. | Sets the maximum volume level of the main zone. | 91 |
| INIT. VOL. | Sets the volume level of the main zone when the power of this unit is turned on. | 91 |

Sound menu 3 SOUND MENU

| Menu | Parameter | Functions | Page |
|-----------------|----------------|---|------|
| A)EQUALIZER | EQ TYPE SELECT | Selects the type of equalizer. | 92 |
| | GEQ | Adjusts the tonal quality of the speakers when you set "EQ TYPE SELECT" to "GEQ". | 92 |
| | TEST | Selects whether this unit outputs the test tone while making adjustments of "GEQ" or not. | 92 |
| B)LFE LEVEL | SPEAKER | Adjusts the speaker LFE level. | 93 |
| | HEADPHONE | Adjusts the headphone LFE level. | 93 |
| C)DYNAMIC RANGE | SPEAKER | Adjusts the amount of the dynamic range compression of the speakers. | 93 |
| | HEADPHONE | Adjusts the amount of the dynamic range compression of the headphones. | 93 |
| D)LIPSYNC | HDMI AUTO | Selects whether this unit activates the automatic audio and video synchronization function (automatic lip sync) or not. | 94 |
| | AUTO | Makes fine adjustments of the audio delay when the automatic audio and video synchronization function is active. | 94 |
| | MANUAL | Adjustment the audio delay manually when the connected video monitor is not compatible with the automatic audio and video synchronization function or "HDMI AUTO" is set to "OFF". | 94 |
| E)EXTD SUR. | — | Use this feature to enjoy 6.1/7.1-channel playback for multi-channel sources using the Dolby Pro Logic IIx, Dolby Digital EX, or DTS-ES decoders by using the connected surround back speakers. | 94 |

Input menu 4 INPUT MENU

Note

Some parameters described below may not be available for all input sources and some parameters are only available for specific input sources.

| Parameter | Functions | Page |
|--|--|------|
| I/O ASSIGNMENT | Assigns the input/output jacks according to the component to be used if the initial settings of this unit do not correspond to your needs. | 95 |
| INPUT RENAME | Changes the name of the input source that appears in the OSD and in the front panel display. | 96 |
| VOL. TRIM | Adjusts the level of the signal input at each jack. | 96 |
| DECODER MODE | Switches the decoder activation mode. You can designate the reassigned digital input jacks for DTS signals. | 96 |
| STANDBY CHARGE | Selects whether this unit charges the battery of the stationed iPod or not when this unit is in the standby mode (see page 29). | 96 |
| PARENTAL LOCK (U.S.A. and Canada models only) | Sets the SIRIUS Parental Lock code number and the channel lock configuration (see page 67) | 96 |
| START PAIRING | Pair the connected Yamaha Bluetooth adapter (such as YBA-10, sold separately) with a Bluetooth component (see page 72). | 97 |
| BGV | Selects the video source played back in the background of the sources input at the MULTI CH INPUT jacks. | 97 |
| INPUT CH | Selects the number of channels input from an external decoder. | 97 |
| FRONT | Selects the analog jacks at which the front channel signals from an external decoder are input when you set "INPUT CH" to "8CH". | 97 |

Option menu 5 OPTION MENU

| Menu | Parameter | Functions | Page |
|---------------|-------------|---|------|
| A>DISPLAY SET | DIMMER | Adjusts the brightness of the front panel display. | 98 |
| | OSD SHIFT | Adjusts the vertical position of the OSD. | 98 |
| | OSD-SOURCE | Sets the amount of time to display the HD Radio information (U.S.A. model only), SIRIUS Satellite Radio information, XM Satellite Radio information, or iPod menu in the video monitor after you perform a certain operation. | 98 |
| | OSD-AMP | Sets the amount of time to display the status information screen after you perform a certain operation. | 98 |
| | FL SCROLL | Selects the mode to display the information of the HD Radio information (U.S.A. model only), SIRIUS Satellite Radio information, XM Satellite Radio information, or iPod menu in the front panel display. | 98 |
| B>VIDEO SET | VIDEO CONV. | Selects whether to convert the video signals input at the VIDEO, S VIDEO, and COMPONENT VIDEO jacks. | 98 |
| | HDMI RES. | Selects whether this unit activates the HDMI up-conversion of the analog video signals input at the VIDEO, S VIDEO, and COMPONENT VIDEO jacks so that the up-scaled video signals are output at the HDMI OUT jack. | 99 |
| | HDMI ASPECT | Adjusts the aspect ratio for analog video signals output at the HDMI OUT jack. | 99 |

| Menu | Parameter | Functions | Page |
|----------------|--------------|--|------|
| C)MEMORY GUARD | — | Prevents accidental changes to sound field program parameter values and other system settings. | 100 |
| D)INIT. CONFIG | AUDIO SELECT | Designates the default audio input jack select setting for the input sources connected to the DIGITAL INPUT jacks when you turn on the power of this unit. | 100 |
| | DECODER MODE | Designates the default decoder mode for the input sources connected to the DIGITAL INPUT jacks when you turn on the power of this unit. | 100 |
| | EXTD SUR. | Designates the extended decoder mode for the input sources connected to the DIGITAL INPUT jacks when you turn on the power of this unit. | 100 |
| E)HDMI SET | S.AUDIO | Selects whether to play back HDMI audio signals on this unit or on another HDMI component connected to the HDMI OUT jack. | 101 |
| F)ZONE2 SET | MAX VOL. | Adjusts the maximum volume level in Zone 2. | 101 |
| | INIT. VOL. | Sets the volume level of Zone 2 when you turn on the power of this unit. | 101 |

■ Signal information SIGNAL INFO

Use this feature to check audio and video signal information (see page 46).

Using SET MENU

Use the remote control to access and adjust each parameter.



- You can change the “SET MENU” parameters while this unit is reproducing sound.
- If you press **Ⓢ**PARAMETER during the “SET MENU” operation, the “SET MENU” operation is canceled.
- Press **Ⓟ**RETURN to return to the previous menu level.

1 Set the operation mode selector to **Ⓜ**AMP and then press **Ⓢ**SET MENU to enter “SET MENU”.

The top “SET MENU” display appears in the OSD.

2 Press **Ⓢ**△ / ▽ to select “MANUAL SETUP”.

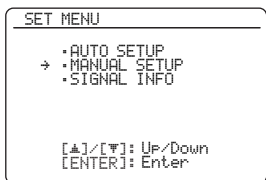

3 Press **Ⓢ**ENTER to enter “MANUAL SETUP”.

The “MANUAL SETUP” display appears in the OSD.

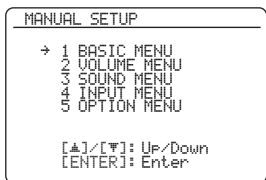

4 Press **Ⓢ**△ / ▽ repeatedly and then press **Ⓢ**ENTER to select and enter the desired menu.

The following displays are examples where “SOUND MENU” is selected.

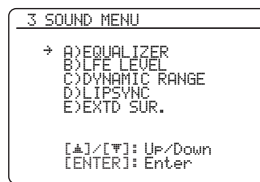

5 Press **Ⓢ**△ / ▽ repeatedly and then press **Ⓢ**ENTER to select and enter the desired submenu.

The following display is an example where “LFE LEVEL” is selected.

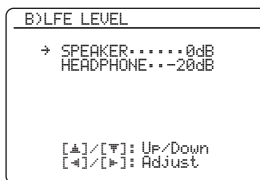

6 Press **Ⓢ**△ / ▽ to select the desired parameter and then **Ⓢ**◀ / ▶ to change the parameter settings.

- Press **Ⓢ**▶ to increase the value.
- Press **Ⓢ**◀ to decrease the value.

7 Press **Ⓢ**SET MENU to exit from “SET MENU”.

1 BASIC MENU

Use this feature to manually adjust the basic speaker settings. Most of the “BASIC MENU” parameters are set automatically when you run the automatic setup.



☀️ Set “TEST TONE” to “ON” to output the test tone for the “SPEAKER SET”, “SP LEVEL” and “SP DISTANCE”.

■ Speaker settings A)SPEAKER SET

☀️ To select the desired parameter, press Ⓚ / ▽ repeatedly.

Extra speaker assignment EXTRA SP ASSIGN
Selects the function of the speakers connected to the EXTRA SP terminals.



| Choice | Descriptions |
|----------|---|
| ZONE2 | Select this setting when you use the Zone 2 speakers (see page 107). |
| FRONT B | Select this setting when you use another front speaker system in the main zone (see page 43). |
| ZONE B | Select this setting when you use another front speaker system in another room (see page 43). |
| PRESENCE | Select this setting when you use the presence speakers (see page 13). |
| NONE | Select this setting when you do not use the EXTRA SP terminals. |

Notes

- This parameter shares the value with the “EXTRA SP ASSIGN” parameter in “AUTO SETUP” (see page 33).
- If you select “ON” in “BI-AMP” (see page 112), you cannot select “PRESENCE” or “ZONE2” in “EXTRA SP ASSIGN”.
- After changing the “EXTRA SP ASSIGN” setting, carry out “AUTO SETUP” again (see page 32).

LFE/bass out LFE/BASS OUT

Use this feature to select the speakers that output the LFE (low-frequency effect) and the low-frequency signals.

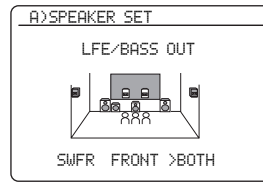

LFE signals output

| Choice | Subwoofer(s) and speakers | | |
|--------|---------------------------|----------------|----------------|
| | Subwoofer(s) | Front speakers | Other speakers |
| BOTH | Output | No output | No output |
| SWFR | Output | No output | No output |
| FRONT | No output | Output | No output |

Low-frequency signals output

| Choice | Subwoofer(s) and speakers | | |
|--------|---------------------------|----------------|----------------|
| | Subwoofer(s) | Front speakers | Other speakers |
| BOTH | *1 | *2 | *3 |
| SWFR | *4 | *3 | *3 |
| FRONT | No output | *1 | *3 |

- *1 Output(s) the low-frequency signals of the front channels and other speakers set to “SMALL”.
- *2 Always output the low-frequency signals of the front channels.
- *3 Output the low-frequency signals if the speakers are set to “LARGE”.
- *4 Outputs the low-frequency signals of the speakers set to “SMALL” or “NONE”.

Measure for the speaker size

- The woofer section of a speaker is
- 16 cm (6.5 in) or larger: large
 - smaller than 16 cm (6.5 in): small

Front speakers FRONT SP

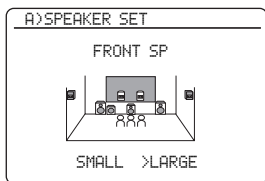

| Choice | Descriptions |
|--------------|--|
| LARGE | Select this setting when the front speakers are large. |
| SMALL | Select this setting when the front speakers are small. |

Note

When "LFE/BASS OUT" is set to "FRONT", you can select only "LARGE" in "FRONT SP". If the value of "FRONT SP" is set to other than "LARGE" in advance, this unit change the value to "LARGE" automatically.

Center speaker CENTER SP

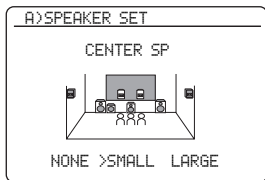

When the center speaker is large:

Select "LARGE" (large).

When the center speaker is small:

Select "SMALL" (small).

When you do not use the center speaker:

Select "NONE" (none). The center channel signals are directed to the front left and right speakers.

| Choice | Descriptions |
|--------------|---|
| LARGE | Select this setting when the center speaker is large. |
| SMALL | Select this setting when the center speaker is small. |
| NONE | Select this setting when you do not use the center speaker. The center channel signals are directed to the front left and right speakers. |

Surround left/right speakers SUR. L/R SP

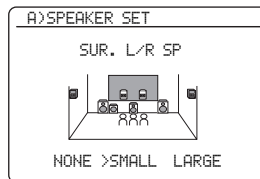

| Choice | Descriptions |
|--------------|--|
| LARGE | Select this setting when the surround speakers are large. |
| SMALL | Select this setting when the surround speakers are small. |
| NONE | Select this setting when you do not use the surround speakers. This unit is set to the Virtual CINEMA DSP mode (see page 51), and "SUR.B L/R SP" is automatically set to "NONE". |

Surround back left/right speakers

SUR.B L/R SP

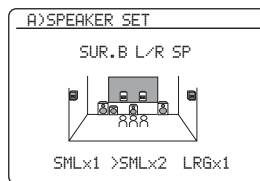

| Choice | Descriptions |
|--------------|---|
| LRGx1 | Select this setting when the single surround back speaker is large. |
| LRGx2 | Select this setting when the surround back left and right speakers are Large. |
| SMLx1 | Select this setting when the single surround back speaker is small. |
| SMLx2 | Select this setting when the surround back left and right speakers are small. |
| NONE | Select this setting when you do not use the surround back speakers. The surround back channel signals are directed to the surround left and right speakers. |

Note

If the Dolby TrueHD audio signals are input and "SUR.B L/R SP" is set to "NONE", the left and right surround back channels are not directed to the surround left and right speakers.

Bass cross over CROSS OVER

Use this feature to select the crossover frequency of all the speakers set to “SML” (or “SMALL”) in “SPEAKER SET” (see page 87). All frequencies below the selected frequency will be sent to the subwoofer(s) or front speakers depending on the setting of “LFE/BASS OUT” in “SPEAKER SET” (see page 87).

Choices: 40Hz, 60Hz, **80Hz**, 90Hz, 100Hz, 110Hz, 120Hz, 160Hz, 200Hz

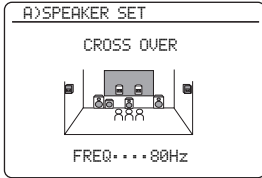

If your subwoofer can adjust the output volume and the crossover frequency, set the volume to about half way (or slightly less) and set the crossover frequency to the maximum.

Subwoofer phase SUBWOOFER PHASE

Use this feature to switch the phase of your subwoofer if bass sounds are lacking or unclear.

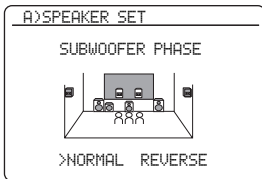

| Choice | Functions |
|---------------------------|--|
| NORMAL (normal) | Does not change the phase of your subwoofer. |
| REVERSE (reverse) | Sets the phase of your subwoofer to reverse. |

Speaker level B>SP LEVEL

Use this feature to manually balance the speaker levels between the front left or surround left speakers and each speaker selected in “SPEAKER SET” (see page 87).

Control range: -10.0 dB to +10.0 dB

Control step: 0.5 dB

Initial setting:

FR.L/FR.R/SWFR/PR.L/PR.R: 0 dB

CNTR/SUR.L/SUR.R/SBL/SBR: -1.0 dB

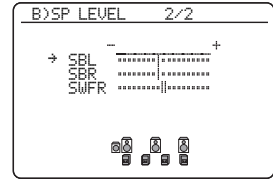
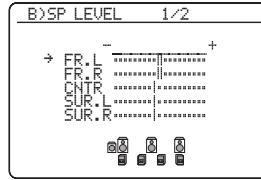

| SP LEVEL | Adjusted speaker |
|----------|-----------------------------|
| FR.L | Front left speaker |
| FR.R | Front right speaker |
| CNTR | Center speaker |
| SUR.L | Surround left speaker |
| SUR.R | Surround right speaker |
| SBL | Surround back left speaker |
| SBR | Surround back right speaker |
| SWFR | Subwoofer |
| PR.L | Presence left speaker |
| PR.R | Presence right speaker |



- If your subwoofer can adjust the output volume and the crossover frequency, set the volume to about half way (or slightly less) and set the crossover frequency to the maximum.
- Set “TEST TONE” to “ON” to output the test tone for the “SPEAKER LEVEL” setting (see page 90).

Notes

- The available speaker channels differ depending on the setting of the speakers.
- Instead of “SBL” and “SBR”, “SB” is displayed if “SUR. B L/R SP” is set to either “SMLx1” or “LRGx1” (see page 88).

■ Speaker distance C)SP DISTANCE

Use this feature to manually adjust the distance of each speaker and the delay applied to the respective channel. Ideally, each speaker should be the same distance from the main listening position. However, this is not possible in most home situations. Thus, a certain amount of delay must be applied to the sound from each speaker so that all sounds will arrive at the listening position at the same time.

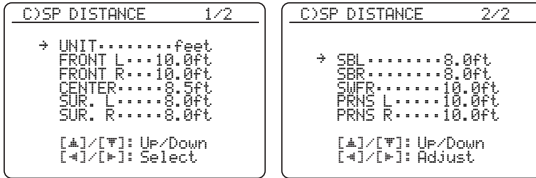

Unit for the speaker distance adjustment UNIT

Initial setting:

[U.S.A. and Canada models]: feet (ft)

[Other models]: meters (m)

| Choice | Functions |
|------------|--------------------------------------|
| meters (m) | Adjusts speaker distances in meters. |
| feet (ft) | Adjusts speaker distances in feet. |

Speaker distances

Control range: 0.30 to 24.00 m (1.0 to 80.0 ft)

Control step: 0.10 m (0.5 ft)

Initial setting:

FRONT L/FRONT R/SWFR/PRNS L/PRNS R: 3.00 m (10.0 ft)

CENTER: 2.60 m (8.5 ft)

SUR. L/SUR. R/SBL/SBR: 2.40 m (8.0 ft)

| SP DISTANCE | Adjusted speaker |
|-------------|-----------------------------|
| FRONT L | Front left speaker |
| FRONT R | Front right speaker |
| CENTER | Center speaker |
| SUR. L | Surround left speaker |
| SUR. R | Surround right speaker |
| SBL | Surround back left speaker |
| SBR | Surround back right speaker |
| SWFR | Subwoofer |
| PRNS L | Presence left speaker |
| PRNS R | Presence right speaker |

Notes

- The available speaker channels differ depending on the setting of the speakers.
- Instead of “SBL” and “SBR”, “SUR.B” is displayed if “SUR.B L/R SP” is set to either “SMLx1” or “LRGx1” (see page 88).

■ Test tone D)TEST TONE

Turns the test tone output on or off for the “SPEAKER SET”, “SP LEVEL”, and “SP DISTANCE” settings.

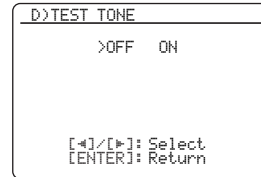

| Choice | Functions |
|--------|--|
| OFF | This unit does not output the test tone for the “SPEAKER SET”, “SP LEVEL”, and “SP DISTANCE” settings. |
| ON | This unit outputs the test tone for the “SPEAKER SET”, “SP LEVEL”, and “SP DISTANCE” settings. |



If you use a handheld sound pressure level meter, hold at arm’s length and point upwards so that the meter is in the listening position. With the meter set to the 70 dB scale and to C SLOW, calibrate each speaker to 75 dB.

Note

This function is automatically turned off if you exit from “BASIC MENU”.

2 VOLUME MENU

Use this menu to manually adjust the various volume settings.

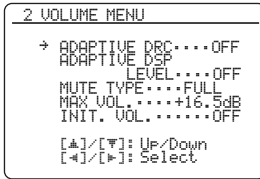

Adaptive dynamic range control

ADAPTIVE DRC

Use this feature to adjust the dynamic range in conjunction with the volume level. This feature is useful when you are listening at lower volumes or at night. When “ADAPTIVE DRC” is set to “AUTO”, this unit controls the dynamic range as follows:

- If the VOLUME setting is low: the dynamic range is narrow
- If the VOLUME setting is high: the dynamic range is wide

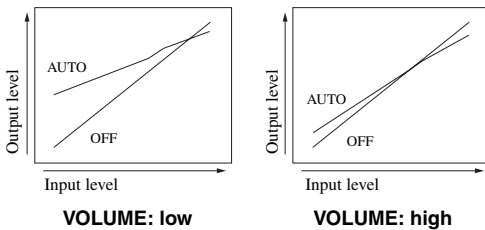

| Choice | Functions |
|--------|--|
| AUTO | Adjusts the dynamic range automatically. |
| OFF | Does not adjust the dynamic range automatically. |



- You can also adjust the dynamic range of the bitstream signal sources by using “DYNAMIC RANGE” in “SOUND MENU” (see page 93).
- This function is also useful for listening with your headphones.

Note

The adaptive dynamic range control feature does not function when this unit is in the Pure Direct mode (see page 52).

Adaptive DSP level ADAPTIVE DSP LEVEL

Use this feature to make fine adjustments of the DSP effect level (see page 75) automatically in conjunction with the volume level.

| Choice | Functions |
|--------|--|
| AUTO | Adjusts the DSP effect level in conjunction with the volume level. |
| OFF | Does not adjust the DSP effect level automatically. |

Note

Even if you set “ADAPTIVE DSP LEVEL” to “AUTO”, this unit does not change but the fine-tunes the specified value of “DSP LEVEL” (see page 75).

Muting type MUTE TYPE

Use this feature to adjust how much the mute function reduces the output volume (see page 45).

| Choice | Functions |
|--------|--------------------------------------|
| FULL | Mutes all the audio output. |
| -20dB | Reduces the current volume by 20 dB. |

Maximum volume MAX VOL.

Use this feature to set the maximum volume level in the main zone. This feature is useful to avoid the unexpected loud sound by mistake. For example, the original volume range is -80.0 dB to +16.5 dB. However, when “MAX VOL.” is set to -5.0 dB, the volume range becomes -80.0 dB to -5.0 dB.

Control range: -30.0 dB to +15.0 dB, **+16.5 dB**

Control step: 5.0 dB

Notes

- When this unit is in the auto setup procedure, the volume level is automatically set to 0 dB regardless of the current “MAX VOL.” setting.
- The “MAX VOL.” setting takes priority over the initial volume setting. For example, if “INI.VOL.” is set to -20.0 dB and “MAX VOL.” is set to -30.0 dB, the volume level is automatically set to -30.0 dB when you turn on the power of this unit next time.
- Use “MAX VOL.” in “ZONE SET” to set the initial volume level in Zone 2.

Initial volume INIT. VOL.

Use this feature to set the volume level of the main zone when the power of this unit is turned on.

Choices: **OFF**, MUTE, -80.0 dB to +16.5 dB

Control step: 0.5 dB

Note

The “MAX VOL.” setting takes priority over the initial volume setting.

3 SOUND MENU

Use this feature to adjust the audio parameters.

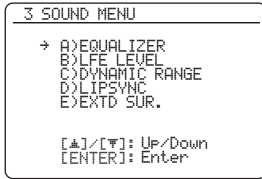

■ Equalizer A)EQUALIZER

Use this feature to select the parametric equalizer or the graphic equalizer.

Equalizer type select EQ TYPE SELECT

Use this feature to select the type of equalizer.

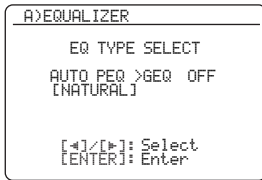

| Choice | Functions |
|----------|--|
| AUTO PEQ | Uses the parametric equalizer adjusted in "AUTO SETUP" (see page 33). |
| GEQ | Adjusts the built-in 7-frequency band graphic equalizer so that the tonal quality of the speakers matches. Press Ⓢ ENTER to display the graphic equalizer screen. |
| OFF | Deactivates the equalizing feature. |



Currently applied parametric equalizer type (see page 33) appears under "AUTO PEQ".

Note

You can select "AUTO PEQ" only when you carry out "AUTO SETUP" in advance (see page 32). In this case, "AUTO PEQ" is automatically selected as the default setting.

Graphic equalizer GEQ

Use this feature to match the tonal quality of the center, surround L/R and surround back L/R, and surround back speakers with that of the front L/R speakers. You can adjust 7 frequency bands (63 Hz, 160 Hz, 400 Hz, 1 kHz, 2.5 kHz, 6.3 kHz, 16 kHz).

Control range: -6.0 dB to +6.0 dB

Control step: 0.5 dB

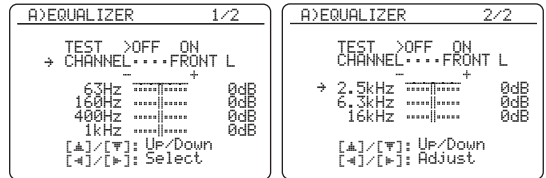

Press **Ⓢ**▲/▼ to select a frequency band and **Ⓢ**◀/▶ to adjust the selected frequency band.

Note

The "GEQ" parameter can be adjusted only when "GEQ" is selected in "EQ TYPE SELECT".

Test tone TEST

Use this feature to make adjustments of "GEQ" while listening to a test tone. To select "TEST", press **Ⓢ**▲/▼ repeatedly in the graphic equalizer screen.

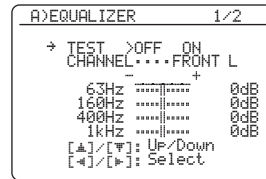

| Choice | Functions |
|--------|--|
| OFF | Does not output test tones and output the currently selected source component. |
| ON | Outputs test tones from the selected speakers. |

■ **Low-frequency effect level**

B>LFE LEVEL

Use this feature to adjust the output level of the LFE (low-frequency effect) channel according to the capacity of your subwoofer or headphones. The LFE channel carries low-frequency special effects which are only added to certain scenes. This setting is effective when the input signal contains the LFE channel.

Control range: -20 to **0** dB

Control step: 1 dB

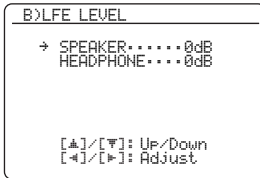

Speakers SPEAKER

Adjusts the speaker LFE level.

Headphones HEADPHONE

Adjusts the headphone LFE level.

Note

Depending on the settings of “LFE/BASS OUT” (see page 87), some signals may not be output at the SUBWOOFER PRE OUT jack.

■ **Dynamic range** C>DYNAMIC RANGE

Use this feature to select the amount of dynamic range compression to be applied to your speakers or headphones. This setting is effective only when this unit is decoding bitstream signals.

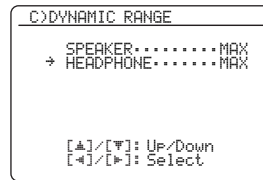

Speakers SPEAKER

Adjusts the dynamic range compression for the speakers.

Headphones HEADPHONE

Adjusts the dynamic range compression for the headphones.

| Choice | Functions |
|----------|---|
| MIN/AUTO | <ul style="list-style-type: none"> • MIN: Adjusts the dynamic range to narrow when this unit is decoding bitstream signals (except Dolby TrueHD). • AUTO: Adjusts the dynamic range according to the instruction of the input source signals when this unit is decoding Dolby TrueHD signals. |
| STD | Adjusts the dynamic range to medium. When this unit is decoding Dolby TrueHD signals, the dynamic range control is always active regardless of the instruction of the input source signals. |
| MAX | Preserves the greatest amount of dynamic range. |

Audio and video synchronization (lip sync) D\LIPSYNC

Use this feature to adjust the audio and video synchronization.

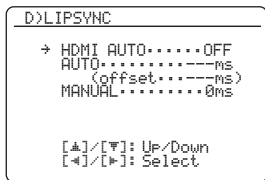

HDMI automatic lip sync mode HDMI AUTO

If the connected video monitor is connected to the HDMI OUT jack of this unit and compatible with the automatic audio and video synchronization function (automatic lip sync), this unit adjusts the audio and video synchronization automatically. Use this feature to activate or deactivate the automatic lip sync.

Choices: ON, **OFF**

If the connected video monitor is compatible with the automatic lip sync:

Select “ON”. Use “AUTO” to make fine adjustments of the audio and video synchronization.

If the video monitor is not compatible with the automatic lip sync or you do not want to use the automatic lip sync:

Select “OFF”. Use “MANUAL” to adjust the audio and video synchronization.

Auto delay AUTO

Use this feature to make fine adjustments of the audio and video synchronization when you set “HDMI AUTO” to “ON”.

Control range: **0** to 240 ms

Control step: 1 ms



“offset” indicates the difference between the value of the audio delay that this unit sets automatically and the value of the audio delay that you set in “AUTO”. This unit stores the value of “offset” and applies the value to other automatic lip sync compatible video monitors.

Manual delay MANUAL

Use this feature to adjust the delay of the sound output manually to synchronize audio with video images when you set “HDMI AUTO” to “OFF”.

Control range: **0** to 240 ms

Control step: 1 ms

Extended surround E\EXTD SUR.

Use this feature to enjoy 6.1/7.1-channel playback for multi-channel sources using the Dolby Pro Logic IIx, Dolby Digital EX, or DTS-ES decoders by using the connected surround back speakers.

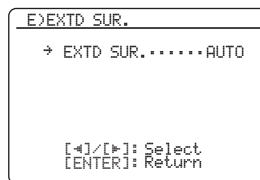

| Choice | Functions |
|-------------|---|
| AUTO | Activates the optimum decoder to play back signals in 6.1/7.1 channels when this unit recognizes a signal flag being input. |
| PLIIxMovie | Plays back Dolby Digital or DTS signals in 7.1 channels using the Pro Logic IIx movie decoder. |
| PLIIxMusic | Plays back Dolby Digital or DTS signals in 6.1/7.1 channels using the Pro Logic IIx music decoder. |
| EX/ES | Plays back Dolby Digital or DTS signals in 6.1/7.1 channels using the Dolby Digital EX or DTS-ES decoder. |
| OFF | Does not use any decoders to create 6.1/7.1 channels. |

4 INPUT MENU

Use this menu to adjust the parameters of each input source.

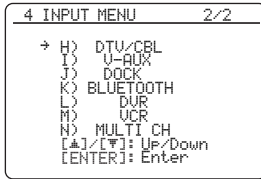
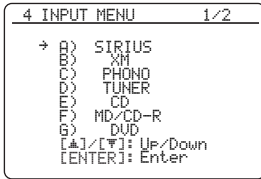

| Input source | Parameter |
|--|---|
| A) SIRIUS (U.S.A. and Canada models only) | INPUT RENAME VOL. TRIM PARENTAL LOCK |
| B) XM (U.S.A. and Canada models only) | INPUT RENAME VOL. TRIM |
| D) TUNER | INPUT RENAME VOL. TRIM |
| N) MULTI CH | INPUT RENAME VOL. TRIM BGV INPUT CH FRONT |
| C) PHONO | I/O ASSIGNMENT |
| E) CD | INPUT RENAME |
| F) MD/CD-R | VOL. TRIM |
| G) DVD | DECODER MODE |
| H) DTV/CBL | |
| I) V-AUX | |
| L) DVR | |
| M) VCR | |
| J) DOCK | INPUT RENAME VOL. TRIM STANDBY CHARGE |
| K) BLUETOOTH | INPUT RENAME VOL. TRIM START PAIRING |

Note

Some parameters described above may not be available for all input sources and some parameters are only available for specific input sources.

Input/output assignment

I/O ASSIGNMENT

Use this feature to assign the input/output jacks according to the component to be used if the initial settings of this unit do not correspond to your needs. Change the parameter to reassign the respective jacks and effectively connect more components.

Once the input/output jacks are reassigned, you can select the corresponding component by using the **Ⓜ** INPUT selector on the front panel (or the input selector buttons on the remote control).

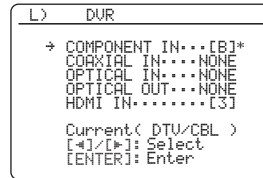

- “NONE” appears in the OSD when any input source is not assigned to the input/output jack.
- Set “OPTICAL OUT” to “(1)” for the digital recording component that you connect to the DIGITAL OUTPUT jack.
- You cannot select a specific item more than once for the same type of jack.
- An asterisk (*) appears to the right of the input/output jack names that have been changed from their previous settings.
- The currently assigned input source for the selected input/output jack appears in the OSD (“Current(DTV/CBL)” in the display example above).

Input rename INPUT RENAME

Use this feature to change the name of the input source that appears in the OSD and in the front panel display.

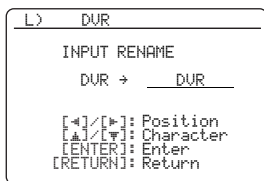

1 Press ⑧</> to place the “_” (underscore) under the space or the character you want to edit.

2 Press ⑧▲/▼ to select the character you want to use and then press ⑧</> to move to the next space.

Notes

- You can use up to 9 characters for each input.
- Press ⑧▼ to change the character in the following order, or press ⑧▲ to go in the reverse order:
 A to Z, 0 to 9, a to z, symbols (#, *, -, +, etc.), space.

3 Repeat steps 1 through 2 to rename each input source.

4 Press ⑧ENTER to complete.

Volume trim VOL. TRIM

Use this feature to adjust the level of the signal input at each jack. This feature is useful if you want to balance the level of each input source to avoid sudden changes in volume when switching between input sources.

Control range: -6.0 dB to +6.0 dB

Control step: 0.5 dB

Initial setting: 0.0 dB

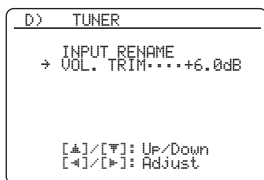

This parameter also affects the signals output at the audio ZONE OUT jacks.

Decoder mode DECODER MODE

Use this feature to switch the decoder activation mode. When you select “DTS” and digital audio signals are input, this unit always activates the DTS decoder and only plays back the DTS digital audio signals.

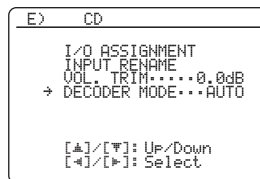

| Choice | Functions |
|--------|---|
| AUTO | Automatically detects digital audio signal input types and selects the appropriate decoder. |
| DTS | Activates the DTS decoder and plays back only DTS digital audio signals when digital audio signals are input. |

Note

“DECODER MODE” is only available when the digital audio input jacks (HDMI, OPTICAL, and/or COAXIAL) are assigned to the selected input source.

SIRIUS Satellite Radio parental lock PARENTAL LOCK

Use this feature to set the code number for locking the desired SIRIUS Satellite Radio channels. Refer to “Setting the Parental Lock” on page 67 for details.

Charge on standby STANDBY CHARGE

Use this feature to select whether this unit charges the battery of the stationed iPod or not when this unit is in the standby mode.

| Choice | Functions |
|--------|--|
| AUTO | Charges the battery of the stationed iPod when this unit is turned on and in the standby mode. |
| OFF | Charges the battery of the stationed iPod only when this unit is turned on. |

Start pairing START PAIRING

Use this feature to start pairing the connected Yamaha Bluetooth adapter (such as YBA-10, sold separately) with your Bluetooth component. For details about the pairing, refer to “Pairing the Bluetooth™ adapter and your Bluetooth component” on page 72.

To ensure security, a time limit of 8 minutes is set for the pairing operation. You are recommended to read and fully understand all the instructions before starting.

1 Press **Ⓜ**ENTER to start pairing.

The connected Bluetooth adapter starts searching Bluetooth components. “Searching...” appears in the video monitor.

2 Check that the Bluetooth component detects the Bluetooth adapter.

If the Bluetooth component the Bluetooth adapter, “YBA-10 YAMAHA” (example) appears in the Bluetooth device list.

3 Select the Bluetooth adapter in the Bluetooth device list and then enter the pass key “0000” on the Bluetooth component.

Once this unit completes the pairing successfully, “Pairing completed” appears.



To cancel the pairing, press **Ⓜ**RETURN to exit from “START PAIRING”.

4 Press **Ⓜ**RETURN to exit from “START PAIRING”.

Notes

- If the connected Bluetooth adapter cannot find any Bluetooth components, “Not found” appears.
- If a Bluetooth adapter is not connected to this unit, “No Bluetooth Adapter” appears.

Multi-channel input BGV BGV

Use this feature to select the video source played in the background of the sources input at the MULTI CH INPUT jacks.

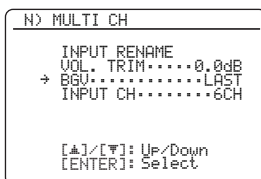

| Choice | Functions |
|--------------------------------------|--|
| LAST | Automatically selects the last selected video source as the background video source. |
| DVD, DTV/ CBL, DVR, VCR, V-AUX | Selects the corresponding input source as the background video source. |
| OFF | Does not play the video source in the background. |

Input channels INPUT CH

Use this setting to select the number of channels input from an external decoder (see page 25).

Choices: **6CH**, **8CH**

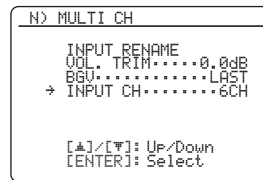

If the connected component outputs discrete 6-channel audio signals.

Select “6CH”.

If the connected component outputs discrete 8-channel audio signals.

Select “8CH”. Also set “FRONT” (see below) to the analog audio jacks at which the front left and right channel signals output from the connected component are input.

Front left and right channels input jack FRONT

If you selected “8CH” in “INPUT CH”, you can select the analog audio jacks at which the front left and right channel signals output from the connected external decoder is input.

Choices: CD, MD/CD-R, **DVD**, DTV/CBL, DVR, VCR, V-AUX

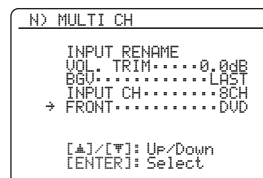

Note

“FRONT” parameter appears only when you set “INPUT CH” to “8CH”.

5 OPTION MENU

Use this menu to adjust the optional system parameters.

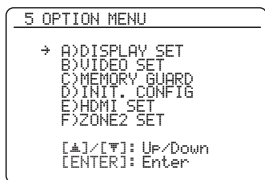

■ Display settings A) DISPLAY SET

Note

Use “VIDEO” of “INIT” in “ADVANCED SETUP” to set “OSD SHIFT” to the factory presets (see page 112).

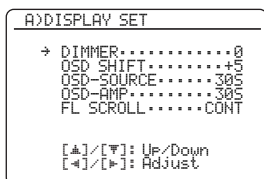

Dimmer DIMMER

Use this feature to adjust the brightness of the front panel display.

Control range: -4 to 0

Control step: 1

- Press Ⓑ◀ to make the front panel display dimmer.
- Press Ⓑ▶ to make the front panel display brighter.

OSD shift OSD SHIFT

Use this feature to adjust the vertical position of the OSD.

Control range: -5 (downward) to +5 (upward)

Control step: 1

Initial setting: 0

- Press Ⓑ◀ to lower the position of the OSD.
- Press Ⓑ▶ to raise the position of the OSD.

Source feature OSD display time OSD-SOURCE

Use this feature to set the amount of time to display the HD Radio (U.S.A. model only), XM Satellite Radio, or SIRIUS Satellite Radio information or iPod menu in the OSD after you perform a certain operation.

| Choice | Functions |
|--------|---|
| ON | Displays the OSD unceasingly during an operation. |
| 10S | Turns off the OSD 10 seconds after you perform a certain operation. |
| 30S | Turns off the OSD 30 seconds after you perform a certain operation. |

Amplifier function OSD display time OSD-AMP

Use this feature to set the amount of time to display the status information screen after you perform a certain operation.

| Choice | Functions |
|--------|---|
| ON | Displays the OSD unceasingly during an operation. |
| 10S | Turns off the OSD 10 seconds after you perform a certain operation. |
| 30S | Turns off the OSD 30 seconds after you perform a certain operation. |

Front panel display scroll FL SCROLL

Use this feature to set the mode to display the HD Radio (U.S.A. model only), XM Satellite Radio information, SIRIUS Satellite Radio information, or iPod menu (such as song title or channel name) in the front panel display.

| Choice | Functions |
|--------|--|
| CONT | Continuous mode. Select this to display the operation status in the front panel display in a continuous manner. |
| ONCE | Scroll-once mode. Select this to display the operation status in the front panel display by the first 14 alphanumeric characters after scrolling all characters once. |

■ Video settings B) VIDEO SET

Note

Use “VIDEO” of “INIT” in “ADVANCED SETUP” to set the parameters in “VIDEO SET” to the factory presets (see page 112).

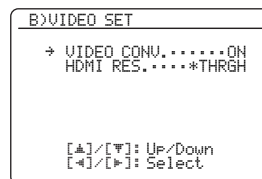

Video conversion VIDEO CONV.

Use this feature to set whether to convert the video signals input at the VIDEO, S VIDEO, and COMPONENT VIDEO jacks.

| Choice | Functions |
|--------|---|
| ON | Converts composite, S-video, and component video signals interchangeably and up-converts composite, S-video, and component video signals to HDMI video signals. |
| OFF | Does not convert any signals. |

Notes

- This unit does not convert 480 line video signals and 576 line video signals interchangeably.
- The analog component video signals with 480i (NTSC)/576i (PAL) of resolution are converted into the S-video or composite video signals and output at the S VIDEO MONITOR OUT and VIDEO MONITOR OUT jacks.
- The converted video signals are only output at the MONITOR OUT jacks. When recording a video source, you must make the same type of video connections between each component.
- When composite video or S-video signals from a VCR are converted into component video signals, the picture quality may suffer depending on your VCR.
- Unconventional signals input at the composite video or S-video jacks cannot be converted or may be output abnormally. In such cases, set "VIDEO CONV." to "OFF".

HDMI resolution HDMI RES.

Use this feature to activate or deactivate the HDMI up-scaling of the analog video signals input at the VIDEO, S VIDEO and COMPONENT VIDEO jacks so that the up-scaled video signals are output at the HDMI OUT jack.

This unit up-scales the video signals as follows:

- 480i (NTSC)/576i (PAL) → 480p/576p, 1080i, 720p, or 1080p
- 480p/576p → 1080i, 720p, or 1080p



| Choice | Functions |
|------------------------------------|--|
| THROUGH | Does not up-scale any analog video signals. |
| 480p (or 576p), 1080i, 720p, 1080p | Up-scales analog video signals to 480p or 576p, 1080i, 720p, or 1080p of resolution. |

Notes

- This unit does not up-scale the analog component video signals with 720p or 1080i of resolution.
- The "HDMI RES." parameter appears only when you set "VIDEO CONV." to "ON".
- If you connect your video monitor via HDMI connection, this unit automatically detects the available video signal resolution of the video monitor, and an asterisk (*) appears on the left of the available video signal resolution(s).
- If this unit cannot detect the available video signal resolution(s) of the connected video monitor, set "MON. CHK" (see page 112) to "SKIP" and then set "HDMI RES." again.
- This unit does not convert between 480 line video signals and 576 line video signals.

HDMI aspect ratio HDMI ASPECT

Use this feature to select the adjustment of aspect ratio for analog video signals output at the HDMI OUT jack.

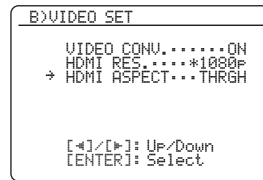

| Choice | Functions |
|--------------|---|
| THRGH | Does not make any adjustments to the aspect ratio for the HDMI video signal sources. |
| 16:9 | Displays video images with the aspect ratio of 4:3 on your video monitor with the aspect ratio of 16:9. Black stripes appear on the right and left sides as a result. |
| SMART | Fits video images with the aspect ratio of 4:3 to your video monitor with the aspect ratio of 16:9. |

Notes

- When "HDMI RES." is set to "THROUGH", you cannot make any adjustments to "HDMI ASPECT".
- If the aspect ratio of the input video source is other than 4:3, this unit automatically ignores the setting of "HDMI ASPECT".
- When "HDMI ASPECT" is set to "SMART", the video images of the edge of the video monitor are rather stretched.
- When the video signals are input at HDMI IN jacks or the signals are input with 720p, 1080i or 1080p of resolution, the setting of "HDMI ASPECT" does not affect the video signals output at the HDMI OUT jack.

Memory guard C>MEMORY GUARD

Use this feature to prevent accidental changes to sound field program parameter and other system settings.

```
C>MEMORY GUARD
      >OFF  ON
      [←]/[→]: Select
      [ENTER]: Return
```

| Choice | Functions |
|--------|--|
| OFF | Turns off the “MEMORY GUARD” feature. |
| ON | Protects: <ul style="list-style-type: none"> – sound field program parameters – “AUTO SETUP” items – all speaker levels – “MANUAL SETUP” items |

Notes

- You can change the following parameters even if “MEMORY GUARD” is set to “ON”:
 - “EXTD SUR.” in “SOUND MENU” (see page 94)
 - “DECODER MODE” in “INPUT MENU” (see page 96)
 - “PARENTAL LOCK” in “INPUT MENU” (see page 96)
 - “MEMORY GUARD”
- When “MEMORY GUARD” is set to “ON”, “” appears at the top right of the “SET MENU” screen.
- You can change the settings of “SUR.” in the sound field program parameter screen (see page 79) even if “MEMORY GUARD” is set to “ON”.

Initial configuration D>INIT. CONFIG

Use this feature to select the settings of the audio input jack select, active decoders and extended surround when you turn on this unit.

```
D>INIT. CONFIG
      → AUDIO SELECT..AUTO
      DECODER MODE..AUTO
      EXTD SUR.....AUTO
      [←]/[→]: Select
      [ENTER]: Return
```

Audio select AUDIO SELECT

Use this feature to designate the default audio input jack select setting (see page 44) for the input sources connected to the DIGITAL INPUT jacks when you turn on the power of this unit.

| Choice | Functions |
|--------|--|
| AUTO | Automatically detects the type of input signals and selects the appropriate audio input jack select setting. |
| LAST | Automatically selects the last input jack select setting used for the connected input source. |

Decoder mode DECODER MODE

Use this feature to designate the default decoder mode (see page 96) for the input sources connected to the DIGITAL INPUT jacks when you turn on the power of this unit.

| Choice | Functions |
|--------|--|
| AUTO | Automatically detects the type of input signals and select the appropriate decoder mode setting. |
| LAST | Automatically selects the last decoder mode setting used for the connected input source. |

Extended surround EXTD SUR.

Use this feature to designate the extended decoder mode (see page 94) for the input sources connected to the DIGITAL INPUT jacks when you turn on the power of this unit.

| Choice | Functions |
|--------|--|
| AUTO | Automatically detects the digital audio input signals and activates the appropriate decoder. |
| LAST | Automatically selects the last decoder mode set for “EXTD SUR.” in “SOUND MENU”. |

■ **HDMI set** E>HDMI SET

Use this feature to select the component to play back HDMI audio signals.

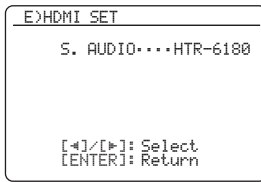

Support audio S.AUDIO

Use this feature to select whether to play back HDMI audio signals on this unit or on another HDMI component connected to the HDMI OUT jack on the rear panel of this unit.

| Choice | Functions |
|-----------------|---|
| HTR-6180 | Plays back HDMI audio signals on this unit. The HDMI audio signals input at the HDMI input jacks of this unit are not output to the HDMI component connected to the HDMI OUT jack on the rear panel of this unit. |
| OTHER | Plays back HDMI audio signals on another HDMI component connected to the HDMI OUT jack. |

Notes

- This unit transmits audio and video signals input at the HDMI input jacks to the HDMI out jack only when this unit is turned on even if “S.AUDIO” is set to “OTHER”.
- Available audio/video signals depend on the specification of the connected video monitor. Refer to the instruction manual of each connected component.

■ **Zone 2 settings** F>ZONE2 SET

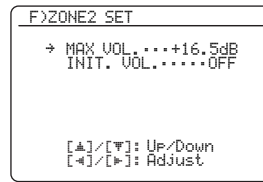

Zone 2 Maximum volume MAX VOL.

Use this feature to set the maximum volume level in the Zone 2.

Control range: -30.0dB to +15.0 dB, **+16.5 dB**

Control step: 5.0 dB

Notes

- The “MAX VOL.” setting takes priority over the “INI.VOL.” setting. For example, when “INI.VOL.” is set to -20.0 dB and then “MAX VOL.” is set to -30.0 dB, the volume level is automatically set to -30.0 dB when you turn on the power of this unit next time.
- The “MAX VOL.” setting does not affect the output level at the “ZONE 2 OUT” jacks.

Zone 2 Initial volume INI.VOL.

Use this feature to set the volume level of Zone 2 when the power of this unit is turned on.

Choices: **OFF**, MUTE, -80.0 dB to +16.5 dB

Control step: 0.5 dB

Notes

- The “MAX VOL.” setting takes priority over the “INI.VOL.” setting.
- When you select “FRONT B”, “PRNS”, “Zone B”, or “NONE” in “EXTRA SP ASSIGN” (see page 87), “Zone 2 SP Not Assigned” appears in the OSD and the “ZONE2 SET” parameter is not available.
- The “INI.VOL.” setting does not affect the output level at the “ZONE 2 OUT” jacks.

Remote control features

In addition to controlling this unit, the remote control can also operate other audiovisual components made by Yamaha and other manufacturers. To control your TV or other components, you must set up the appropriate remote control code for each input source (see page 104).

Controlling this unit, a TV, or other components

■ Controlling this unit

Set the operation mode selector to **16 AMP** to control this unit.

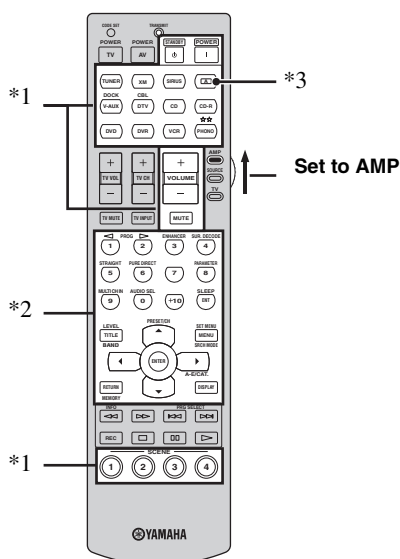

■ Controlling a TV

Set the operation mode selector to **16 TV** to control your TV. To control your TV, you must set the appropriate remote control code for **4 DTV/CBL** or **4 PHONO** (see page 104). When you set the remote control codes for both **4 DTV/CBL** and **4 PHONO**, priority is given to the one set for **4 DTV/CBL**.

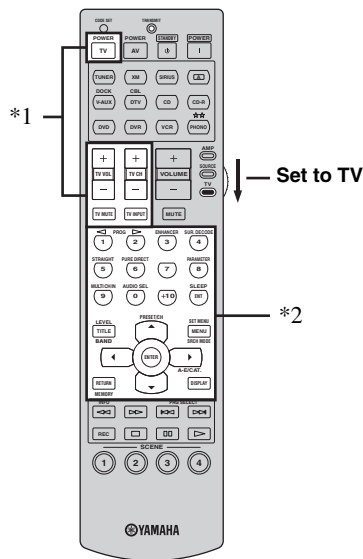

Notes

- *1 These buttons always control this unit regardless of the operation mode selector position.
- *2 These buttons control this unit only when the component operation mode selector is set to **16 AMP**.
- *3 **4 A** is the optional component control area button. You can control the desired component without changing the input source of this unit.

Notes

- *1 These buttons always control your TV regardless of the operation mode selector position.

| Remote control | Digital TV/Cable TV |
|----------------|--|
| TV POWER | Turns the power on or off. |
| TV VOL +/- | Increases or decreases the volume level. |
| TV CH +/- | Changes the channel number. |
| TV MUTE | Mutes the audio output. |
| TV INPUT | Changes the input source. |

- *2 These buttons control your TV only when the operation mode selector is set to **16 TV**. For details, see the "Digital TV/Cable TV" column on page 103.

■ Controlling other components

Set the operation mode selector to **⑩SOURCE** to control other components selected with the input selector buttons (④). You must set the appropriate remote control code for each input source in advance (see page 104). The following table shows the function of each control button used to control other components assigned to each input selector button (④). Be advised that some buttons may not correctly operate the selected component.



The remote control has 12 modes (control areas) to control components so that the remote control can operate up to 12 different components.

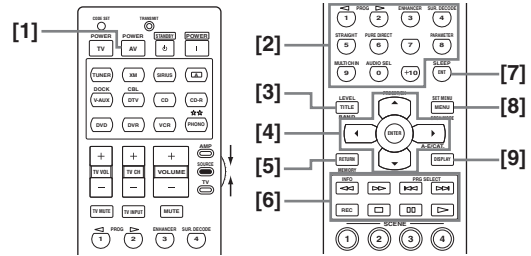

| Remote control | DVD player/recorder | VCR | Digital TV/Cable TV | LD player | CD player | MD/CD recorder | Tuner |
|------------------------------------|--------------------------------------|------------------|---------------------|-----------------|-----------------|-----------------|---------------------------------------|
| [1] AV POWER | Power *1 | Power *1 | Power *2 | Power *1 | Power *1 | Power *1 | |
| [2] 1-9, 0, +10 | Numeric buttons | Numeric buttons | Numeric buttons | Numeric buttons | Numeric buttons | Numeric buttons | Preset stations (1-8)/Numeric buttons |
| [3] TITLE | Title | | | | | | Band |
| [4] PRESET/CH Δ | Up | VCR channel up | Up | | | | Preset up (1-8)/Tuning up |
| PRESET/CH ∇ | Down | VCR channel down | Down | | | | Preset down (1-8)/Tuning down |
| A-E/CAT. \triangleleft | Left | | Left | | | | Preset down (A-E) |
| A-E/CAT. \triangleright | Right | | Right | | | | Preset up (A-E) |
| ENTER | Enter | | Enter | | | | Hold |
| [5] RETURN | Return | | Return | | | | Memory |
| [6] REC | Disc skip (player) Rec (recorder) | Rec | Rec *2 | | Disc skip | Rec | |
| \triangleright | Play | Play | Play *2 | Play | Play | Play | |
| $\triangleleft\triangleleft$ /INFO | Search backward | Search backward | Search backward *2 | Search backward | Search backward | Search backward | Information |
| $\triangleright\triangleright$ | Search forward | Search forward | Search forward *2 | Search forward | Search forward | Search forward | |
| $\square\square$ | Pause | Pause | Pause *2 | Pause | Pause | Pause | |
| $\triangleleft\triangleleft$ | Skip backward | Skip backward | Skip backward *2 | Skip backward | Skip backward | Skip backward | Audio program down |
| $\triangleright\triangleright$ | Skip forward | Skip forward | Skip forward *2 | Skip forward | Skip forward | Skip forward | Audio program up |
| \square | Stop | Stop | Stop *2 | Stop | Stop | Stop | |
| [7] ENT | Title/Index | Enter | Enter | Chapter/Time | Index | Index | Enter |
| [8] MENU | Menu | | Menu | | | | Search mode |
| [9] DISPLAY | Display | Display | Display | Display | Display | Display | Display |

Notes

*1 This button is operational only when the original remote control supplied with the component has a POWER button.

*2 These buttons operate your VCR or DVD recorder only when you set the appropriate remote control code for DVR (see page 104).

Setting remote control codes

You can control other components by setting the appropriate remote control codes. For a complete list of available remote control codes, refer to “List of remote control codes” at the end of this manual.

Remote control code default settings

| Input source | Component category | Manufacturer | Default code |
|--------------|--------------------------------|--------------|--------------|
| TUNER | TUNER | Yamaha | 82915 |
| XM | TUNER | Yamaha | 82918 |
| SIRIUS | TUNER | Yamaha | 82176 |
| A | – | – | – |
| V-AUX | OTHER AUDIO ACCESSORIES (iPod) | Yamaha | 82981 |
| DTV/CBL | – | – | – |
| CD | CD | Yamaha | 62907 |
| MD/CD-R | CD-R | Yamaha | 71292 |
| DVD | DVD | Yamaha | 42543 |
| DVR | DVR | Yamaha | 52544 |
| VCR | – | – | – |
| PHONO | – | – | – |

Note

You may not be able to operate your Yamaha component even if a Yamaha remote control code is preset as listed above. In this case, try setting another Yamaha remote control code.

- 1 Press one of the input selector buttons (④) on the remote control to select the control area you want to set up.

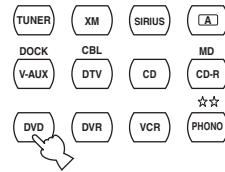

- 2 Press ② CODE SET using a ballpoint pen or a similar object.

The ⑫ TRANSMIT indicator on the remote control flashes twice, and the selected input selector button lights up.

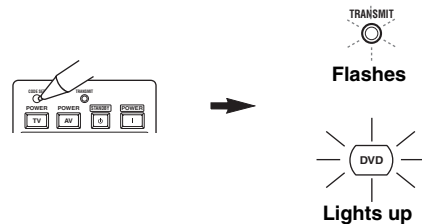

- 3 Press the numeric buttons (0 to 9) (⑥) to enter the five-digit remote control code for the component to be used.

The ⑫ TRANSMIT indicator on the remote control flashes twice, and the remote control code for the selected component is set.

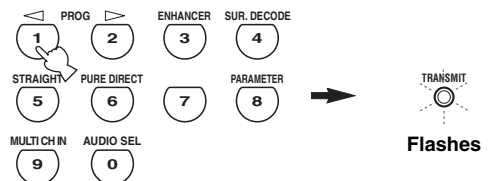

Refer to “List of remote control codes” at the end of this manual.

Notes

- If the manufacturer of your component has more than one code, try each of them until you find the correct one.
- If you do not press any buttons within 30 seconds in step 3, the setup process is canceled. If this happens, repeat the setup procedure.
- If you enter the code number “9980”, the remote control code previously set for the selected control area is cleared.

Resetting all remote control codes

Use this feature to clear all the remote control codes previously set and reset all of them to the initial factory settings.

1 Press **Ⓜ** CODE SET using a ballpoint pen or a similar object.

The **Ⓜ** TRANSMIT indicator on the remote control flashes twice.

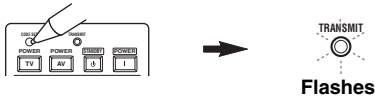

2 Press the numeric buttons (Ⓜ) to enter the code number “9981”.

The **Ⓜ** TRANSMIT indicator on the remote control flashes twice, and all the remote control codes previously set are cleared and reset to the initial factory settings.

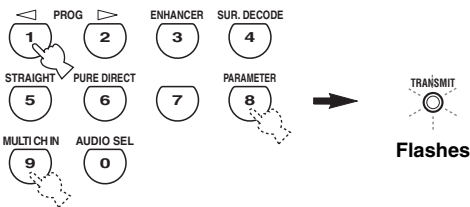

If you do not press any buttons within 30 seconds after step 1, the clearing process is canceled. In this case, repeat the clearing procedure.

Using multi-zone configuration

This unit allows you to configure a multi-zone audio system. The Zone 2 feature allows you to set this unit to reproduce separate input sources in the main zone and the second zone (Zone 2). You can control this unit from the second zone using the supplied remote control.

Only analog signals are sent to the second zone. Any source you want to listen to in the second zone must be connected to the analog AUDIO IN jacks of this unit.

Connecting Zone 2

You need the following additional equipment to use the multi-zone functions of this unit:

- An infrared signal receiver in the second zone.
- An infrared signal emitter in the main zone. This emitter transmits the infrared signals from the remote control via the infrared signal receiver in the second zone to a CD player or a DVD player, etc. in the main zone.
- An amplifier and speakers in the second zone.



- Since there are many possible ways to connect and use this unit in a multi-zone configuration, we recommend that you consult with your nearest authorized Yamaha dealer or service center about the Zone 2 connections that best meet your requirements.
- Some Yamaha models are able to connect directly to the REMOTE jacks of this unit. If you own these products, you may not need to use an infrared signal emitter. Up to 6 Yamaha components can be connected as shown below.

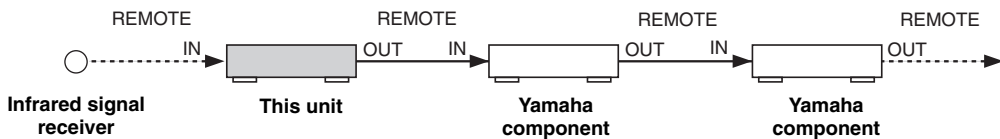

■ Using the external amplifier

Connect the amplifier/receiver in the second zone and other components to this unit as follows.

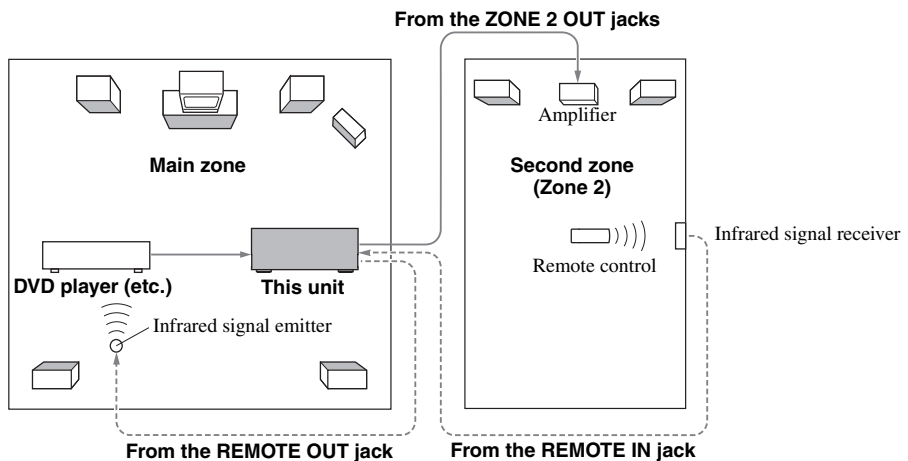

Note

To avoid unexpected noise, DO NOT USE the Zone 2 feature with CDs encoded in DTS.

■ Using the internal amplifier of this unit

Important safety notice

The EXTRA SP speaker terminals of this Receiver should not be connected to a Passive Loudspeaker Selector Box or more than one loudspeaker per channel.

Connection to a Passive Loudspeaker Selector Box or multiple speakers per channel could create an abnormally low impedance load resulting in amplifier damage. See this owner's manual for correct usage.

Compliance with minimum speaker impedance information for all channels must be maintained at all times. This information is found on the back panel of your Receiver.

Connect the speakers in the second zone to the EXTRA SP speaker terminals and then set the "EXTRA SP ASSIGN" to "ZONE2" (see page 87).

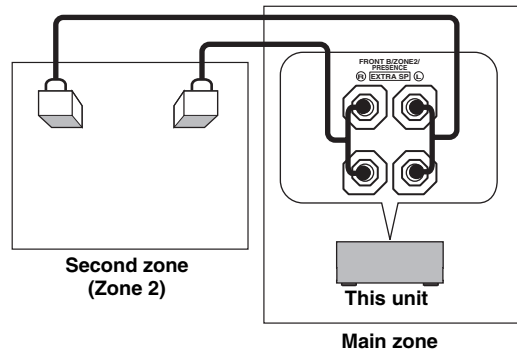

- You can use the speakers connected EXTRA SP speaker terminals as the front speaker system of another zone. Set "EXTRA SP ASSIGN" to "ZONE B" (see page 87).
- When you use the internal amplifiers for the Zone 2 speakers, you can adjust the volume level and set the initial volume level and maximum volume level of the Zone 2 speakers (see page 101).

Controlling Zone 2

You can select and control Zone 2 by using the control buttons on the front panel or on the remote control. The available operations are as follows:

- Selecting the input source of Zone 2.
- Tuning into FM or AM when "TUNER" is selected as the input source of Zone 2 (see page 53).
- Tuning into XM Satellite Radio when "XM" is selected as the input source of Zone 2 (see page 59) (U.S.A. and Canada models only).
- Tuning into SIRIUS Satellite Radio when "SIRIUS" is selected as the input source of Zone 2 (see page 64) (U.S.A. and Canada models only).
- Enjoying music stored on your iPod stationed in a Yamaha iPod universal dock (such as YDS-10 sold separately) connected to the DOCK terminal of this unit when "V-AUX" is selected as the input source (see page 70).

Note

You must complete each step while the ZONE2 indicator is flashing in the front panel display. Otherwise, the Zone 2 mode is automatically canceled and this unit returns to the normal operation mode. In this case, repeat the Zone 2 selection procedure.

■ Controlling Zone 2 with the front panel

Turning on Zone 2

Press **Ⓜ** ZONE 2 ON/OFF to turn on Zone 2.

Activating the Zone 2 operation mode

Press **Ⓜ** ZONE CONTROL to control Zone 2.

The ZONE2 indicator flashes in the front panel display for approximately 10 seconds.

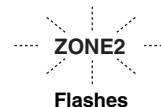

Operate the following operations after activating the Zone 2 operation mode.

Operating Zone 2

Rotate the **(R) INPUT** selector to select the desired input source while the **ZONE2** indicator is flashing in the front panel display.

- Select “TUNER” as the input source to use the TUNER features in Zone 2. For details about the TUNER operations, see “FM/AM tuning” on page 53.
- Select “XM” as the input source to use the XM Satellite Radio features in Zone 2. For details about the XM Satellite Radio operations, see “XM Satellite Radio tuning” on page 59.
- Select “SIRIUS” as the input source to use the SIRIUS Satellite Radio features in Zone 2. For details about the SIRIUS Satellite Radio operations, see “SIRIUS Satellite Radio™ tuning” on page 64.
- Select “V-AUX” as the input source to use iPod features or Bluetooth features in Zone 2. For details about the iPod operations, see “Using iPod™” on page 70 or “Using Bluetooth™ components” on page 72.

Set Zone 2 to the standby mode

Press **(H) ZONE 2 ON/OFF** to set Zone 2 to the standby mode.



Press **(L) SYSTEM OFF** to set the main zone and Zone 2 to the standby mode simultaneously.

Setting the remote control to the Zone 2 mode

The remote control is originally set to the main mode to control the main zone. To control Zone 2 with the remote control, you must first set the remote control to the Zone 2 mode.

1 Press **(2) CODE SET** using a ballpoint pen or a similar object.

The **(12) TRANSMIT** indicator on the remote control flashes twice.

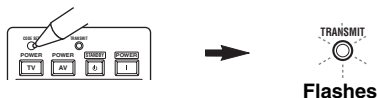

2 Press the numeric buttons **(6)** to enter the code number “9992”.

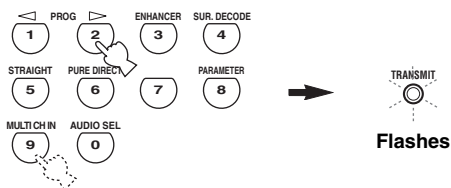

Controlling Zone 2 with the remote control

Turning on Zone 2

Press and hold **(14) POWER** or **(13) STANDBY** and then press **(4) ☆☆** to set the remote control to the Zone 2 mode.

- Press **(14) POWER** when the main zone is turned on.
- Press **(13) STANDBY** when the main zone is turned off.

The **(12) TRANSMIT** indicator on the remote control lights up while the remote control is set to the Zone 2 mode.

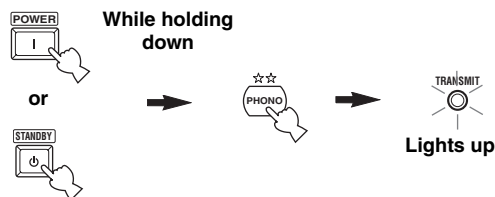

Notes

- When the remote control is set to the Zone 2 mode, **(14) POWER**, **(13) STANDBY**, **(15) VOLUME +/-**, **(17) MUTE**, and the input selector buttons **(4)** are set to control Zone 2. However, the rest of the remote control buttons remain in the main mode.
- The remote control automatically exits from the Zone 2 mode in the following cases:
 - when you do not make any operations within 10 seconds after the remote control is set to the Zone 2 mode.
 - when you press a remote control button other than **(14) POWER**, **(13) STANDBY**, **(15) VOLUME +/-**, **(17) MUTE**, the **(11) SCENE** buttons and the input selector buttons **(4)**.

Activating the Zone 2 operation mode

Press **(14) POWER** to turn on Zone 2.

Operating Zone 2

Press one of the input selector buttons **(4)** to select the desired input source of Zone 2.

Setting Zone 2 to the standby mode

Press **(13) STANDBY** to set Zone 2 to the standby mode.

Advanced setup

This unit has additional menus that are displayed in the front panel display. The advanced setup menu offers additional operations to adjust and customize the way this unit operates. Change the initial settings (indicated in bold under each parameter) to reflect the needs of your listening environment.

Notes

- The settings you make are reflected next time you press **ⓀMAIN ZONE ON/OFF** to turn on this unit (see page 29).
- Only **ⓀMAIN ZONE ON/OFF**, **ⓁSYSTEM OFF**, **ⓂTONE CONTROL** and the **ⓃPROGRAM** selector are effective while you are using the advanced setup menu.
- No other operations can be made while you are using the advanced setup menu.
- The advanced setup menu is only available in the front panel display.

Using the advanced setup

1 Press ⓁSYSTEM OFF on the front panel to set this unit to the standby mode.

2 Press and hold ⓂTONE CONTROL and then press ⓀMAIN ZONE ON/OFF to turn on this unit.

This unit turns on, and the advanced setup menu appears in the front panel display.



3 Rotate the ⓃPROGRAM selector to select the parameter you want to adjust.

The name of the selected parameter appears in the front panel display.

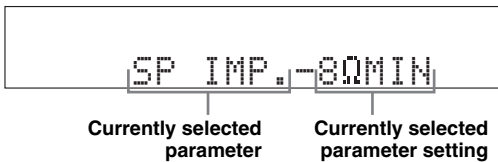

4 Press ⓂTONE CONTROL repeatedly to change the selected parameter setting.

5 Press ⓁSYSTEM OFF to save the new setting and set this unit to the standby mode.



The settings you made are reflected next time you turn on this unit.

■ Speaker impedance SP IMP.

Use this feature to set the speaker impedance of this unit so that it matches that of your speakers.

Choices: **8ΩMIN**, 6ΩMIN

- Select “8ΩMIN” to set the speaker impedance to 8 Ω.
- Select “6ΩMIN” to set the speaker impedance to 6 Ω.

| SP IMP. | Speaker | Impedance level |
|---------|---------------|--|
| 8ΩMIN | Front | If you use one set (A or B), the impedance of each speaker must be 8 Ω or higher. If you use two sets (A and B), the impedance of each speaker must be 16 Ω or higher.* |
| | Center | |
| | Surround | The impedance of each speaker must be 8 Ω or higher. |
| | Surround back | |
| 6ΩMIN | Front | If you use one set (A or B), the impedance of each speaker must be 4 Ω or higher. If you use two sets (A and B), the impedance of each speaker must be 8 Ω or higher. |
| | Center | |
| | Surround | The impedance of each speaker must be 6 Ω or higher. |
| | Surround back | |

* The Canada model cannot use two separate speaker systems (A and B) simultaneously when “SP IMP.” is set to “8ΩMIN”.

See page 109 for the operation of the advanced setup.

Remote control AMP ID REMOTE AMP

Use this feature to set the AMP ID of this unit for remote control recognition. This feature is useful when you operate this unit and the other Yamaha receivers/amplifiers in the same room separately.

Choices: ID1, ID2

- Select “ID1” when the remote control AMP ID code is set to “00001”.
- Select “ID2” when the remote control AMP ID code is set to “00002”.

Setting remote control AMP ID codes

You need to set the remote control AMP ID code for the remote control.

1 Press ② CODE SET using a ballpoint pen or a similar object.

The ⑫ TRANSMIT indicator on the remote control flashes twice.

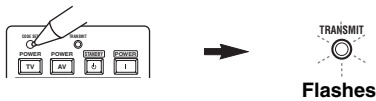

2 Press the numeric buttons (⑥) to enter the code number “00001” or “00002”.

The ⑫ TRANSMIT indicator on the remote control flashes twice, and the AMP ID code is changed.

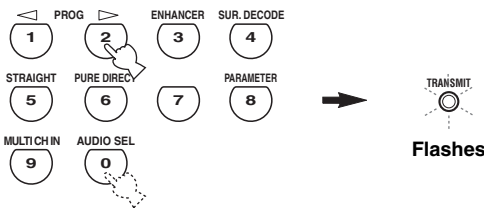

| AMP ID code *1 | Function | Remote control AMP ID *2 |
|----------------------------|---|--------------------------|
| 00001 (initial setting) | To operate this unit using the default code. | ID1 (initial setting) |
| 00002 | To operate this unit using an alternative code. | ID2 |

*1 The remote control setting

*2 The setting of this unit

Remote control TUNER ID REMOTE TU

Use this feature to set the TUNER ID of this unit for remote control recognition.

Choices: ID1, ID2

- Select “ID1” when the remote control TUNER ID code is set to “82915”.
- Select “ID2” when the remote control TUNER ID code is set to “82178”.

Setting remote control TUNER ID codes

You need to set the remote control TUNER ID library code for the remote control.

1 Press ④ TUNER to select “TUNER” as the input source.



2 Press ② CODE SET using a ballpoint pen or a similar object.

The ⑫ TRANSMIT indicator on the remote control flashes twice.

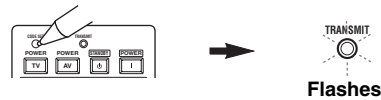

3 Press the numeric buttons (⑥) to enter the code number “82915” or “82178”.

The ⑫ TRANSMIT indicator on the remote control flashes twice, and the TUNER ID code is changed.

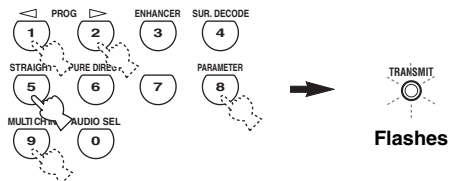

| TUNER ID code *1 | Function | Remote control TUNER ID *2 |
|----------------------------|---|----------------------------|
| 82915 (initial setting) | To operate this unit using the default code. | ID1 (initial setting) |
| 82178 | To operate this unit using an alternative code. | ID2 |

*1 The remote control setting

*2 The setting of this unit

See page 109 for the operation of the advanced setup.

■ Remote control XM ID REMOTE XM (U.S.A. and Canada models only)

Use this feature to set the XM ID of this unit for remote control recognition.

Choices: ID1, ID2

- Select "ID1" when the remote control XM ID code is set to "82918".
- Select "ID2" when the remote control XM ID code is set to "82179".

Setting remote control XM ID codes

You need to set the remote control XM ID code for the remote control.

- 1 Press **④** XM to select "XM" as the input source.



- 2 Press **②** CODE SET using a ballpoint pen or a similar object.

The **⑫** TRANSMIT indicator on the remote control flashes twice.

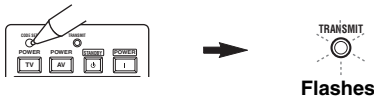

- 3 Press the numeric buttons **⑥** to enter the code number "82918" or "82179".

The **⑫** TRANSMIT indicator on the remote control flashes twice, and the XM ID code is changed.

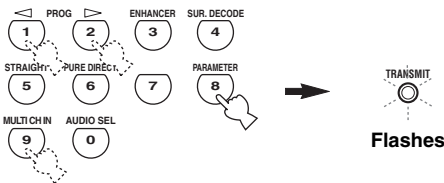

| XM ID code *1 | Function | Remote control XM ID *2 |
|----------------------------|---|--------------------------|
| 82918 (initial setting) | To operate this unit using the default code. | ID1 (initial setting) |
| 82179 | To operate this unit using an alternative code. | ID2 |

*1 The remote control setting

*2 The setting of this unit

■ Remote control SIRIUS ID REMOTE SR (U.S.A. and Canada models only)

Use this feature to set the SIRIUS ID of this unit for remote control recognition.

Choices: ID1, ID2

- Select "ID1" when the remote control SIRIUS ID code is set to "82176".
- Select "ID2" when the remote control SIRIUS ID code is set to "82177".

Setting remote control SIRIUS ID codes

You need to set the remote control SIRIUS ID code for the remote control.

- 1 Press **④** TUNER to select "SIRIUS" as the input source.



- 2 Press **②** CODE SET using a ballpoint pen or a similar object.

The **⑫** TRANSMIT indicator on the remote control flashes twice.

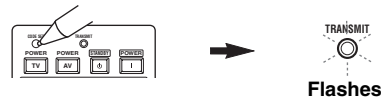

- 3 Press the numeric buttons **⑥** to enter the code number "82176" or "82177".

The **⑫** TRANSMIT indicator on the remote control flashes twice, and the SIRIUS ID code is changed.

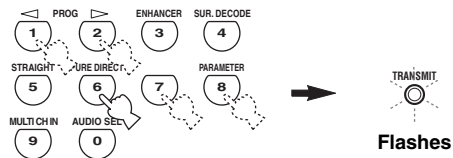

| SIRIUS ID code *1 | Function | Remote control SIRIUS ID *2 |
|----------------------------|---|-----------------------------|
| 82176 (initial setting) | To operate this unit using the default code. | ID1 (initial setting) |
| 82177 | To operate this unit using an alternative code. | ID2 |

*1 The remote control setting

*2 The setting of this unit

See page 109 for the operation of the advanced setup.

■ SIRIUS Satellite Radio Parental Lock personal identification number reset SR PIN

Use this feature to set the code number (personal identification number) for the SIRIUS Satellite Radio Parental Lock feature to the initial factory setting. This feature is useful when you forget or want to change the current code number.

Choices: RESET, **CANCEL**

- Select “RESET” to set the code number to the initial factory setting.
- Select “CANCEL” to set the code number to the initial factory setting.

Note

Even if you set “SR PIN” to “RESET”, this unit does not unlock the locked channels. The initial factory setting of the Parental Lock code number is “0000”.

■ Bi-amplifier setting BI-AMP

Use this feature to activate or deactivate the bi-amplifier function (see page 16).

Choices: ON, **OFF**

- Select “ON” if you want to activate the bi-amplifier function. “SUR.B L/R SP” is set to “NONE” automatically, and this unit outputs the front channel audio signals at the SURROUND BACK/BI-AMP speaker terminals.
- Select “OFF” if you want to deactivate the bi-amplifier function.

Note

When “BI-AMP” is set to “ON”, you can only select “FRONT B”, “ZONE B”, or “NONE” in “EXTRA SP ASSIGN” (see page 87).

■ SCENE IR code setting SCENE IR

Use this feature to output the remote control signals at the REMOTE OUT jack automatically when this unit is in the SCENE mode.

Choices: **ON**, OFF

- Select “ON” when the component connected to the REMOTE OUT jack is the Yamaha component and has the capability of the SCENE control signals. This unit automatically sends the remote control signals to the component.
- Select “OFF” when the component connected to the REMOTE OUT jack is not the Yamaha component and does not have the capability of the SCENE control signals.

Note

If noises are output when you operate the SCENE function, set “SCENE IR” to “OFF”.

■ Monitor check MON. CHK

Use this feature to activate or deactivate the monitor check function of this unit. When “MON. CHK” is set to “YES”, this unit receives the information of the available video signal resolutions from the video monitor connected via HDMI and you can only select the resolutions supported by the video monitor in “HDMI RES.” (see page 99). When “MON. CHK” is set to “SKIP”, you can select any resolution in “HDMI RES.”.

Choices: **YES**, SKIP

■ Parameter initialization INIT

Use this feature to reset the parameters of this unit to the initial factory settings. You can select the category of parameters to be initialized.

Choices: DSP PARAM, VIDEO, ALL, **CANCEL**

- Select “DSP PARAM” to initialize all the parameters of the sound field programs (see page 74).
- Select “VIDEO” to initialize the parameters in “VIDEO SET” (see page 98) and “OSD SHIFT” in “DISPLAY SET” (see page 98).
- Select “ALL” to initialize all the parameters of this unit.
- Select “CANCEL” to cancel the initialization procedure.

Note

Use “INITIALIZE” in the sound field program menu to initialize the parameters of the desired program (see page 74).

Troubleshooting

Refer to the table below when this unit does not function properly. If the problem you are experiencing is not listed below or if the instruction below does not help, turn off this unit, disconnect the power cable, and contact the nearest authorized Yamaha dealer or service center.

■ General

| Problem | Cause | Remedy | See page |
|---|--|---|--------------|
| This unit fails to turn on or enters the standby mode soon after the power is turned on. | The power cable is not connected or the plug is not completely inserted. | Connect the power cable firmly. | — |
| | The speaker impedance setting is incorrect. | Set the speaker impedance to match your speakers. | 28 |
| | The protection circuitry has been activated. | Make sure that all speaker wire connections on this unit and on all speakers are secure and that the wires for each connection do not touch anything other than their respective connections. | 14 |
| | This unit has been exposed to a strong external electric shock (such as lightning or strong static electricity). | Set this unit to the standby mode, disconnect the power cable, plug it back in after 30 seconds and then use this unit normally. | — |
| No sound. | Incorrect input or output cable connections. | Connect the cables properly. If the problem persists, the cables may be defective. | 20-26 |
| | The optimizer microphone is connected. | Disconnect the optimizer microphone. | 36 |
| | Audio input jack select is set to "HDMI", "COAX/OPT" or "ANALOG". | Set Audio input jack select to "AUTO". | 44 |
| | Audio input jack select is set to "ANALOG" while playing a source encoded in Dolby Digital or DTS. | Set Audio input jack select to "AUTO" or "COAX/OPT". | 44 |
| | No appropriate input source has been selected. | Select an appropriate input source with the INPUT selector on the front panel (or the input selector buttons on the remote control). | 42, 43 |
| | Speaker connections are not secure. | Secure the connections. | 14 |
| | The front speakers to be used have not been selected properly. | Select the front speakers by pressing (A) SPEAKERS on the front panel repeatedly. | 43 |
| | The volume is turned down. | Turn up the volume. | — |
| | The sound is muted. | Press (7) MUTE or (15) VOLUME +/- on the remote control to resume audio output and then adjust the volume. | 45 |
| | Signals this unit cannot reproduce are being input from a source component, such as a CD-ROM. | Play a source whose signals can be reproduced by this unit. | — |
| | The HDMI components connected to this unit do not support the HDCP copy protection standards. | Connect HDMI components that support the HDCP copy protection standards. | 18 |
| | "S.AUDIO" is set to "OTHER" and "HDMI" audio signals are not being played back on this unit. | Set "S.AUDIO" to "HTR-6180" in "MANUAL SETUP". | 101 |
| No picture. | The output and input for the picture are connected to different types of video jacks. | Set "VIDEO CONV." to "ON" or connect your source components in the same way as you connect your video monitor to this unit. | 98 |
| | Non-standard video signals are input. | | |
| The sound suddenly goes off. | The protection circuitry has been activated because of a short circuit, etc. | Check that the speaker impedance setting is correct. Check that the speaker wires are not touching each other and then turn this unit back on. | 28, 109 — |
| | The sleep timer has turned this unit off. | Turn this unit on, and play the source again. | — |
| | The sound is muted. | Press (7) MUTE or (15) VOLUME +/- on the remote control to resume audio output. | 45 |
| | | | |
| Sound is heard from the speaker on one side only. | Incorrect cable connections. | Connect the cables properly. If the problem persists, the cables may be defective. | 14 |
| | Incorrect settings in "SP LEVEL". | Adjust the "SP LEVEL" settings. | 89 |

| Problem | Cause | Remedy | See page |
|--|---|--|----------|
| Only the center speaker outputs substantial sound. | When playing a monaural source with a sound field program, the source signal is directed to the center channel, and the front and surround speakers output effect sounds. | | |
| No sound is heard from the center speaker. | “CENTER SP” in “SET MENU” is set to “NONE”. | Set “CENTER SP” to “SMALL” or “LARGE”. | 88 |
| | One of the sound field programs (except for “7ch Stereo”) has been selected. | Try another sound field program. | 48 |
| No sound is heard from the presence speakers. | The sound field programs are turned off. | Press STRAIGHT to turn them on. | 51 |
| | You are using a source or program combination that does not output sound from all channels. | Try another sound field program. | 42 |
| | “EXTRA SP ASSIGN” is set to a setting other than “PRESENCE”. | Set “EXTRA SP ASSIGN” to “PRESENCE”. | 87 |
| No sound is heard from the surround speakers. | “SUR. L/R SP” in “SET MENU” is set to “NONE”. | Set “SUR. L/R SP” to “SML” or “LRG”. | 88 |
| | This unit is in the “STRAIGHT” mode and a monaural source is being played back. | Press STRAIGHT on the front panel so that “STRAIGHT” disappears from the front panel display. | 51 |
| No sound is heard from the surround back speakers. | “SUR. L/R SP” in “SET MENU” is set to “NONE” and “SUR.B L/R SP” is automatically set to “NONE”. | Set “SUR. L/R SP” and “SUR.B L/R SP” to a setting other than “NONE”. | 88 |
| | “SUR.B L/R SP” in “SET MENU” is set to “NONE”. | Set “SUR.B L/R SP” to a setting other than “NONE”. | 88 |
| Zone 2 speaker settings are not available in “SET MENU”. | “EXTRA SP ASSIGN” is set to a setting other than “ZONE2”. | Set “EXTRA SP ASSIGN” to “ZONE2”. | 87 |
| FRONT B speakers cannot be activated. | “EXTRA SP ASSIGN” is set to a setting other than “FRONT B”. | Set “EXTRA SP ASSIGN” to “FRONT B”. | 87 |
| No sound from the center, surround or surround back speakers when the FRONT B speakers are activated. | “EXTRA SP ASSIGN” is set to “ZONE B”. | Set “EXTRA SP ASSIGN” to “FRONT B”. | 87 |
| Presence speaker settings are not available in “SET MENU”. | “EXTRA SP ASSIGN” is set to a setting other than “PRESENCE”. | Set “EXTRA SP ASSIGN” to “PRESENCE”. | 87 |
| No sound is heard from the subwoofer. | “LFE/BASS OUT” in “SET MENU” is set to “FRONT” when a Dolby Digital or DTS signal is being played. | Set “LFE/BASS OUT” to “SWFR” or “BOTH”. | 87 |
| | “LFE/BASS OUT” in “SET MENU” is set to “SWFR” or “FRONT” when a 2-channel source is being played. | Set “LFE/BASS OUT” to “BOTH”. | 87 |
| | The source does not contain low-frequency signals. | | |
| Dolby Digital or DTS sources cannot be played. (Dolby Digital or DTS indicator in the front panel display does not light up.) | The connected component is not set to output Dolby Digital or DTS digital signals. | Make an appropriate setting following the operating instructions for your component. | — |
| | Audio input jack select is set to “ANALOG”. | Set Audio input jack select to “AUTO”. | 44 |
| A humming sound is heard. | Incorrect cable connections. | Connect the audio cables firmly. If the problem persists, the cables may be defective. | — |
| | No connection from the turntable to the GND terminal. | Connect the grounding cable of your turntable to the GND terminal of this unit. | 23 |
| The volume level is low while a record is being played. | The record is being played on a turntable with an MC cartridge. | Connect your turntable to this unit through an MC-head amplifier. | 23 |

| Problem | Cause | Remedy | See page |
|---|---|--|----------|
| The volume level cannot be increased, or the sound is distorted. | The component connected to the AUDIO OUT (REC) jacks of this unit is turned off. | Turn on the power of the component. | — |
| The sound effects cannot be recorded. | It is not possible to record the sound effects with a recording component. | | |
| A source cannot be recorded by a digital recording component connected to the DIGITAL OUTPUT jack. | The source component is not connected to the DIGITAL INPUT jacks of this unit. | Connect the source component to the DIGITAL INPUT jacks. | 21, 23 |
| | Some components cannot record Dolby Digital or DTS sources. (U.S.A. model only) HD Radio signals are not output at the DIGITAL OUTPUT jacks. | Connect the recording component to the analog AUDIO OUT (REC) jacks. | — |
| A source cannot be recorded by an analog component connected to the AUDIO OUT (REC) jacks. | The source component is not connected to the analog AUDIO IN jacks of this unit. | Connect the source component to the analog AUDIO IN jacks. | 23 |
| | XM Satellite Radio and SIRIUS Satellite Radio signals are not output at the AUDIO OUT (REC) jacks. | | |
| The sound field parameters and some other settings of this unit cannot be changed. | “MEMORY GUARD” in “SET MENU” is set to “ON”. | Set “MEMORY GUARD” to “OFF”. | 100 |
| This unit does not operate properly. | The internal microcomputer has been frozen by an external electric shock (such as lightning or excessive static electricity) or by a power supply with low voltage. | Disconnect the power cable from the AC wall outlet and then plug it in again after about 30 seconds. | — |
| No sound is heard from the connected HDMI component. | The HDMI component does not accept the multi-channel audio signals. | Convert the multi-channel audio signals to the 2-channel audio signals at the source component such as a DVD player. | — |
| “CHECK SP WIRES” appears in the front panel display. | Speaker cables are short-circuited. | Make sure all speaker cables are connected correctly. | 14 |
| There is noise interference from digital or radio frequency equipment. | This unit is too close to the digital or high-frequency equipment. | Move this unit further away from such equipment. | — |
| The picture is disturbed. | The video source uses scrambled or encoded signals to prevent dubbing. | | |
| This unit suddenly enters the standby mode. | The internal temperature is too high and the overheat protection circuitry has been activated. | Wait about 1 hour for this unit to cool down and then turn it back on. | — |

■ HDMI

| Problem | Cause | Remedy | See page |
|-----------------------------|--|--|----------|
| No picture or sound. | The number of the connected HDMI components is over the limit. | Reduce the number of the connected HDMI components. | — |
| | HDCP authentication failed. | Check that the connected HDMI components support the HDCP copy protection standards. | — |

■ Tuner (FM/AM)

| | Problem | Cause | Remedy | See page |
|--|--|---|--|----------|
| FM | FM stereo reception is noisy. | The characteristics of FM stereo broadcasts may cause this problem when the transmitter is too far away or the antenna input is poor. | Check the antenna connections. | 27 |
| | | | Try using a high-quality directional FM antenna. | — |
| | | | Use the manual tuning method. | 53 |
| | There is distortion, and clear reception cannot be obtained even with a good FM antenna. | There is multi-path interference. | Adjust the antenna position to eliminate multi-path interference. | — |
| The desired station cannot be tuned into with the automatic tuning method. | The signal is too weak. | Use a high-quality directional FM antenna. | — | |
| | | Use the manual tuning method. | 53 | |
| Previously preset stations can no longer be tuned into. | This unit has been disconnected for a long period. | Preset the stations again. | 54 | |
| AM | The desired station cannot be tuned into with the automatic tuning method. | The signal is weak or the antenna connections are loose. | Tighten the AM loop antenna connections and orient the antenna for the best reception. | — |
| | | | Use the manual tuning method. | 53 |
| | There are continuous crackling and hissing noises. | Noise can result from lightning, fluorescent lamps, motors, thermostats and other electrical equipment. | Use an outdoor antenna and a ground wire. This will help somewhat, but it is difficult to eliminate all noise. | — |
| | There are buzzing and whining noises. | A TV set is being used nearby. | Move this unit away from the TV set. | — |

■ HD Radio (U.S.A. model only)

| | Problem | Cause | Remedy | See page |
|--|---|--|---|----------|
| This unit cannot receive the HD Radio signals of the selected radio station. | | The radio station provides analog FM/AM radio service only. | Select other radio stations that provides the HD Radio service. | 53 |
| | | Tuning mode is set to “MANUAL TUNING”. | Set the tuning mode to “AUTO TUNING”. | 53 |
| | | The signal is too weak. | Adjust the antenna position. | — |
| | | | Use a high-quality FM/AM antenna. | — |
| This unit cannot select other audio programs than the main program. | The radio station provides an audio program only. | Select an FM HD Radio station that provides multiple audio programs. | 53 | |
| HD Radio information does not appear. | The radio station does not provide the information. | Select other radio stations that provides the HD Radio information. | 53 | |

■ XM Satellite Radio

If an operation takes longer than usual or an error occurs, one of the following messages may appear in the front panel display. In this case, read the cause and follow the corresponding remedies.

| Status message | Cause | Remedy | See page |
|----------------|--|--|----------|
| CHECK XM TUNER | The XM Mini-Tuner is not installed in the XM Mini-Tuner Dock or the XM Mini-Tuner dock is not connected to this unit. | Confirm the XM Mini-Tuner is fully seated in the dock and check the XM Mini-Tuner dock cable is connected to this unit. | 59, 63 |
| CHECK ANTENNA | The XM antenna is not connected to the XM Mini-Tuner Dock or the XM antenna cable has become damaged. | Check that the XM antenna is securely connected to the XM Mini-Tuner Dock and check the antenna cable for damage. Replace the XM antenna if the cable is damaged. | 59 |
| LOADING | The XM Mini-Tuner is acquiring audio or program information from the XM satellite signal. This message can also occur in weak XM signal conditions. Note that this unit may not respond to some operations while this message is displayed. | This message should disappear in a few seconds in good signal conditions. If you see this message often, reposition the XM antenna to get better signal reception. Use the "ANTENNA INFO" information in the front panel or "XM Information" screen in the video monitor to check the antenna reception level. | 63 |
| NO SIGNAL | The XM Mini-Tuner is not receiving the XM satellite signal. Something may be blocking the XM antenna's view of the satellites or the antenna is not properly aimed. | Check for antenna obstructions and reposition the XM antenna to get better signal reception. Use the "ANTENNA INFO" information in the front panel or "XM Information" screen in the video monitor to check the antenna reception level. See instructions supplied with the XM Mini-Tuner and Dock for antenna installation information. | 59 |
| OFF AIR | The XM channel you selected is not currently broadcasting. | Check back at a later time; in the mean time, select another channel. | — |
| CH UNAUTH | You may be attempting to tune to an XM channel that is blocked or that you cannot receive with your XM subscription package. | Consult the latest channel guide at http://www.xmradio.com/ (US residents) and http://www.xmradio.ca/ (Canadian residents) for the current list of channels. For information on receiving this channel, visit http://www.xmradio.com/ (US residents) and http://www.xmradio.ca/ (Canadian residents) or contact XM Satellite Radio at 1-800-967-2346 (US residents) and 1-877-438-9677 (Canadian residents). | 60 |
| CH UNAVAIL | The selected channel is not available. The channel may have been reassigned to a different channel number. This message may occur initially with a new XM Mini-Tuner or an XM Mini-Tuner that has not received XM's signal for an extended period. | Consult the latest channel guide at http://www.xmradio.com/ (US residents) and http://www.xmradio.ca/ (Canadian residents) for the current list of channels. For cases of a new XM Mini-Tuner or an XM Mini-Tuner that has not received XM's signal for an extended period, allow the XM Mini-Tuner to receive the XM satellite signal for at least 5 minutes and then try to select the channel again. | — |
| - - - - | No artist name or song title is available for this selection. | No action required. | — |

■ SIRIUS Satellite Radio

If an operation takes longer than usual or an error occurs, one of the following messages may appear in the front panel display. In this case, read the cause and follow the corresponding remedies.

| Status message | Cause | Remedy | See page |
|--|---|---|----------|
| ANTENNA ERROR | The antenna is not connected to the SiriusConnect tuner properly. | Check the connection of the antenna and SiriusConnect tuner. | 64 |
| CHECK SR TUNER | The SiriusConnect tuner is not connected to the SIRIUS jack of this unit correctly. | Check the connection of the SiriusConnect tuner and this unit. | 64 |
| | The SiriusConnect tuner is not connected to the AC wall outlet. | Connect the power cable of the SiriusConnect tuner to the AC wall outlet. | 64 |
| NOT SUPPORTED | This unit does not support the connected SIRIUS Satellite Radio tuner. | Connect the SiriusConnect tuner that this unit supports. | 64 |
| ACQUIRING | The signal is too weak. | Adjust the orientation of the antenna of the SiriusConnect tuner. Use the "ANTENNA INFO" information in the front panel display or "SIRIUS Information" screen in the video monitor to check the antenna reception level. | 64, 69 |
| UPDATING | The SiriusConnect tuner is updating the channel list. | Wait until the updating is complete. | — |
| | The period of the subscription is end. | Contact SIRIUS Satellite Radio to renew the subscription. | 65 |
| F/W UPDATING | The SiriusConnect tuner is updating the firmware. | Wait until the updating is complete. | — |
| CALL SIRIUS (CALL 888-539- SIRIUS TO SUBSCRIBE) | The selected channel is not subscribed. | Contact SIRIUS Satellite Radio to subscribe the selected channel. URL: https://activate.siriusradio.com/ Phone: 1-888-539-SIRIUS (1-888-539-7474) | 65 |
| | | Select another channel. | 65 |
| SUB UPDATED | The subscription information is updated. | | |
| INVALID | The selected channel is currently out of service. | Select another channel. | 65 |
| Not Available | The operation you made is not available. | | |

■ Remote control

| Problem | Cause | Remedy | See page |
|--|---|---|----------|
| The remote control does not work or function properly. | Wrong distance or angle. | The remote control will function within a maximum range of 6 m (20 ft) and no more than 30 degrees off-axis from the front panel. | 31 |
| | Direct sunlight or lighting (from an inverter type of fluorescent lamp, etc.) is striking the remote control sensor of this unit. | Reposition this unit. | — |
| | The batteries are weak. | Replace all batteries. | — |
| | The operation mode selector is set incorrectly. | Set the operation mode selector correctly. When operating this unit, set it to the ⓂAMP position. When operating the component selected by the input selector button, set it to the ⓂSOURCE position. When operating the TV set in the ④DTV or ④PHONO area, set it to the ⓂTV position. | — |
| | The remote control code was not correctly set. | Set the remote control code correctly using "List of remote control codes" at the end of this manual. | 104 |
| | | Try setting another code of the same manufacturer using "List of remote control codes" at the end of this manual. | 104 |
| The ID code of the remote control and the remote control ID of this unit do not match. | Match the remote control ID of this unit with the corresponding remote control ID code. | 110 | |

■ iPod

Note

In case of a transmission error without a status message appearing in the front panel and in the OSD, check the connection to your iPod (see page 25).

| Status message | Cause | Remedy | See page |
|----------------|--|--|----------|
| Loading... | This unit is in the middle of recognizing the connection with your iPod. This unit is in the middle of acquiring song lists from your iPod. | | |
| Connect error | There is a problem with the signal path from your iPod to this unit. | Turn off this unit and reconnect the Yamaha iPod universal dock to the DOCK terminal of this unit. Try resetting your iPod. | 25 — |
| Unknown iPod | The iPod being used is not supported by this unit. | Only iPod (Click and Wheel), iPod nano, and iPod mini are supported. | — |
| iPod connected | Your iPod is properly stationed in a Yamaha iPod universal dock (such as YDS-10, sold separately) connected to the DOCK terminal of this unit, and the connection between your iPod and this unit is complete. | | |
| Disconnected | Your iPod was removed from a Yamaha iPod universal dock (such as YDS-10 sold separately) connected to the DOCK terminal of this unit. | Station your iPod back in a Yamaha iPod universal dock (such as YDS-10 sold separately) connected to the DOCK terminal of this unit. | 25 |
| Unable to play | This unit cannot play back the songs currently stored on your iPod. | Check that the songs currently stored on your iPod are playable. Store some other playable music files on your iPod. | — — |

■ Bluetooth

| Status message | Cause | Remedy | See page |
|----------------|--|--|----------|
| Searching... | The Bluetooth adapter and the Bluetooth component is in the middle of the pairing. The Bluetooth adapter and the Bluetooth component is in the middle of establishing the connection. | | |
| Completed | The pairing is completed. | | |
| Canceled | The pairing is canceled. | | |
| BT connected | The connection between the Yamaha Bluetooth adapter (such as YBA-10, sold separately) and the Bluetooth component is established. | | |
| Disconnected | The Bluetooth component is disconnected from the Yamaha Bluetooth adapter (such as YBA-10, sold separately). | | |
| No BT adapter | The Bluetooth adapter is not connected to the DOCK terminal. | Connect the Yamaha Bluetooth adapter (such as YBA-10, sold separately) to the DOCK terminal. | 25 |

■ AUTO SETUP

Before AUTO SETUP

| Error message | Cause | Remedy | See page |
|---------------|--|---|----------|
| Connect MIC! | Optimizer microphone is not connected. | Connect the supplied optimizer microphone to the OPTIMIZER MIC jack on the front panel. | 32 |
| Unplug HP! | Headphones are connected. | Unplug the headphones. | — |
| Memory Guard! | The parameters of this unit are protected. | Set "MEMORY GUARD" to "OFF". | 100 |

During AUTO SETUP

| Error message | Cause | Remedy | See page |
|---------------------|---|--|----------|
| E-1:NO FRONT SP | Front L/R channel signals are not detected. | Check the front L/R speaker connections. | 14 |
| E-2:NO SUR SP | A surround channel signal is not detected. | Check the surround speaker connections. | 14 |
| E-3:NO PRNS SP | A presence channel signal is not detected. | Check the presence speaker connections. | 14 |
| E-4:SBR->SBL | Only a right surround back channel signal is detected. | Connect the surround back speaker to the LEFT SURROUND BACK SPEAKERS terminal if you only have one surround back speaker. | 14 |
| E-5:NOISY | Background noise is too loud. | Try running "AUTO SETUP" in a quiet environment. Turn off noisy electric equipment like air conditioners or move them away from the optimizer microphone. | — — |
| E-6:CHECK SUR. | Surround back speakers are connected, though surround L/R speakers are not. | Connect surround speakers when you use surround back speakers. | 14 |
| E-7:NO MIC | The optimizer microphone was unplugged during the "AUTO SETUP" procedure. | Connect the supplied optimizer microphone to the OPTIMIZER MIC jack on the front panel. | 32 |
| E-8:NO SIGNAL | The optimizer microphone does not detect test tones. | Check the microphone setting. Check the speaker connections and placement. | 32 14 |
| E-9:USER CANCEL | The "AUTO SETUP" procedure was cancelled due to user activity. | Run "AUTO SETUP" again. | 32 |
| E-10:INTERNAL ERROR | An internal error occurred. | Run "AUTO SETUP" again. | 32 |

After AUTO SETUP

| Warning message | Cause | Remedy | See page |
|----------------------|--|--|----------|
| W-1: OUT OF PHASE | Speaker polarity is not correct. This message may appear depending on the speakers even when the speakers are connected correctly. | Check the speaker connections for proper polarity (+ or -). | 14 |
| W-2: OVER 24m (80ft) | The distance between the speaker and the listening position is over 24 m (80 ft). | Bring the speaker closer to the listening position. | — |
| W-3: LEVEL ERROR | The difference of volume level among speakers is excessive. | Readjust the speaker installation so that all speakers are set in locations with similar conditions. | — |
| | | Check the speaker connections. | 14 |
| | | Use speakers of similar quality. | — |
| | | When “SWFR: TOO LOUD” or “SWFR: TOO LOW” appears in the result screen, the output volume of the subwoofer. | 32 |
| W-4: CHECK PRNS | “EXTRA SP ASSIGN” is set to “PRESENCE”, though the presence channel signals are not detected. | Check the presence speaker connections. | 14 |
| | | Set “EXTRA SP ASSIGN” to a setting other than “PRESENCE”. | 33 |

Notes

- If the “ERROR” or “WARNING” screens appears, check the cause of the problem, then run “AUTO SETUP” again.
- If a warning message “W-1”, “W-2”, or “W-3” appears, corrections are made, but they may not be optimal.
- If an error message “E-10” occurs repeatedly, contact a qualified Yamaha service center.

Resetting the system

Use this feature to reset all the parameters of this unit to the initial factory settings.

Notes

- This procedure completely resets all the parameters of this unit including the “SET MENU” parameters.
- The initial factory settings are activated next time you turn on this unit.



To cancel the initialization procedure at any time without making any changes, press **ⓁSYSTEM OFF** on the front panel.

1 Press **ⓁSYSTEM OFF on the front panel to set this unit to the standby mode.**

2 Press and hold **ⓂTONE CONTROL and then press **ⓀMAIN ZONE ON/OFF** to turn on this unit.**

This unit turns on, and the advanced setup menu appears in the front panel display.



3 Rotate the **ⓃPROGRAM selector to select “INIT”.**

4 Press **ⓂTONE CONTROL repeatedly to select “ALL”.**



Select “CANCEL” to cancel the initialization procedure without making any changes.

5 Press **ⓁSYSTEM OFF to confirm your selection and set this unit to the standby mode.**

■ Audio and video synchronization (lip sync)

Lip sync, an abbreviation for lip synchronization, is a technical term that involves both a problem and a capability of maintaining audio and video signals synchronized during post-production and transmission. Whereas the audio and video latency requires complex end-user adjustments, HDMI version 1.3 incorporates an automatic audio and video syncing capability that allows devices to perform this synchronization automatically and accurately without user interaction.

■ Bi-amplification connection

A bi-amplification connection uses two amplifiers for a speaker. One amplifier is connected to the woofer section of a loudspeaker while the other is connected to the combined mid and tweeter section. With this arrangement each amplifier operates over a restricted frequency range. This restricted range presents each amplifier with a much simpler job and each amplifier is less likely to influence the sound in some way. The internal crossover of the speaker consists of a LPF (low pass filter) and a HPF (high pass filter). As its name implies, the LPF passes frequencies below a cutoff and rejects frequencies above the cutoff frequency. Likewise, the HPF passes frequencies above its cutoff.

■ Component video signal

With the component video signal system, the video signal is separated into the Y signal for the luminance and the Pb and Pr signals for the chrominance. Color can be reproduced more faithfully with this system because each of these signals is independent. The component signal is also called the “color difference signal” because the luminance signal is subtracted from the color signal. A monitor with component input jacks is required in order to output component signals.

■ Composite video signal

With the composite video signal system, the video signal is composed of three basic elements of a video picture: color, brightness and synchronization data. A composite video jack on a video component transmits these three elements combined.

■ Deep Color

Deep Color refers to the use of various color depths in displays, up from the 24-bit depths in previous versions of the HDMI specification. This extra bit depth allows HDTVs and other displays go from millions of colors to billions of colors and eliminate on-screen color banding for smooth tonal transitions and subtle gradations between colors. The increased contrast ratio can represent many times more shades of gray between black and white. Also Deep Color increases the number of available colors within the boundaries defined by the RGB or YCbCr color space.

■ Dolby Digital

Dolby Digital is a digital surround sound system that gives you completely independent multi-channel audio. With 3 front channels (front L/R and center), and 2 surround stereo channels, Dolby Digital provides 5 full-range audio channels. With an additional channel especially for bass effects, called LFE (Low Frequency Effect), the system has a total of 5.1-channels (LFE is counted as 0.1 channel). By using 2-channel stereo for the surround speakers, more accurate moving sound effects and surround sound environment are possible than with Dolby Surround. The wide dynamic range from maximum to minimum volume reproduced by the 5 full-range channels and the precise sound orientation generated using digital sound processing provide listeners with unprecedented excitement and realism. With this unit, any sound environment from monaural up to a 5.1-channel configuration can be freely selected for your enjoyment.

■ Dolby Digital EX

Dolby Digital EX creates 6 full-bandwidth output channels from 5.1-channel sources. This is done using a matrix decoder that derives 3 surround channels from the 2 in the original recording. For the best results, Dolby Digital EX should be used with movie sound tracks recorded with Dolby Digital Surround EX. With this additional channel, you can experience more dynamic and realistic moving sound especially with scenes with “fly-over” and “fly-around” effects.

■ Dolby Digital Plus

Dolby Digital Plus is an advanced audio technology developed for high-definition programming and media including HD broadcasts, HD DVD, and Blu-ray Disc. Selected as a mandatory audio standard for HD DVD and as an optional audio standard for Blu-ray Disc, this technology delivers multichannel sound with discrete channel output. Supporting bitrates up to 6.0 Mbps, Dolby Digital Plus can carry up to 7.1 discreet audio channels simultaneously. Supported by HDMI version 1.3 and designed for the optical disc players and AV receivers/amplifiers of the future, Dolby Digital Plus also remains fully compatible with the existing multichannel audio systems that incorporate Dolby Digital.

■ Dolby Pro Logic II

Dolby Pro Logic II is an improved technique used to decode vast numbers of existing Dolby Surround sources. This new technology enables a discrete 5-channel playback with 2 front left and right channels, 1 center channel, and 2 surround left and right channels instead of only 1 surround channel for conventional Pro Logic technology. There are three modes available: “Music mode” for music sources, “Movie mode” for movie sources and “Game mode” for game sources.

■ Dolby Pro Logic IIx

Dolby Pro Logic IIx is a new technology enabling discrete multi-channel playback from 2-channel or multi-channel sources. There are three modes available: “Music mode” for music sources, “Movie mode” for movie sources (for 2-channel sources only) and “Game mode” for game sources.

■ Dolby Surround

Dolby Surround uses a 4-channel analog recording system to reproduce realistic and dynamic sound effects: 2 front left and right channels (stereo), a center channel for dialog (monaural), and a surround channel for special sound effects (monaural). The surround channel reproduces sound within a narrow frequency range. Dolby Surround is widely used with nearly all video tapes and laser discs, and in many TV and cable broadcasts as well. The Dolby Pro Logic decoder built into this unit employs a digital signal processing system that automatically stabilizes the volume on each channel to enhance moving sound effects and directionality.

■ Dolby TrueHD

Dolby TrueHD is an advanced lossless audio technology developed for high-definition disc-based media including HD DVD and Blu-ray Disc. Selected as a mandatory audio standard for HD DVD and as an optional audio standard for Blu-ray Disc, this technology delivers sound that is bit-for-bit identical to the studio master, offering a high-definition home theater experience. Supporting bitrates up to 18.0 Mbps, Dolby TrueHD can carry up to 8 discrete channels of 24-bit/96 kHz audio simultaneously. Supported by HDMI version 1.3 and designed for the optical disc players and AV receivers/amplifiers of the future, Dolby TrueHD also remains fully compatible with the existing multichannel audio systems and retains the metadata capability of Dolby Digital, allowing dialog normalization and dynamic range control.

■ DSD

Direct Stream Digital (DSD) technology stores audio signals on digital storage media, such as Super Audio CDs. Using DSD, signals are stored as single bit values at a high-frequency sampling rate of 2.8224 MHz, while noise shaping and oversampling are used to reduce distortion, a common occurrence with very high quantization of audio signals. Due to the high sampling rate, better audio quality can be achieved than that offered by the PCM format used for normal audio CDs.

■ DTS 96/24

DTS 96/24 offers an unprecedented level of audio quality for multi-channel sound on DVD video, and is fully backward-compatible with all DTS decoders. “96” refers to a 96 kHz sampling rate compared to the typical 48 kHz sampling rate. “24” refers to 24-bit word length. DTS 96/24 offers sound quality transparent to the original 96/24 master, and 96/24 5.1-channel sound with full-quality full-motion video for music programs and motion picture soundtracks on DVD video.

■ DTS Digital Surround

DTS digital surround was developed to replace the analog soundtracks of movies with a 6.1-channel digital sound track, and is now rapidly gaining popularity in movie theaters around the world. DTS, Inc. has developed a home theater system so that you can enjoy the depth of sound and natural spatial representation of DTS digital surround in your home. This system produces practically distortion-free 6.1-channel sound (technically, front left and right, center, surround left and right, and LFE 0.1 (subwoofer) channels for a total of 5.1 channels). This unit incorporates a DTS-ES decoder that enables 6.1-channel reproduction by adding the surround back channel to the existing 5.1-channel format.

■ DTS Express

DTS Express is an advanced audio technology for the optional feature on Blu-ray Disc or HD DVD, which offers high-quality, low bit rate audio optimized for network streaming, and Internet applications. DTS Express is used for the Secondary Audio feature of Blu-ray Disc or the Sub Audio feature of HD DVD. These features deliver audio commentaries (for example, the additional commentaries made by the director of a film) on demand by the users via the Internet, etc. DTS Express signals are mixed down with the main audio stream on the player component, and the component sends the mixed audio stream to the AV receivers/amplifiers via digital coaxial, digital optical, or analog connections.

■ DTS-HD High Resolution Audio

DTS-HD High Resolution Audio is an high resolution audio technology developed for high-definition disc-based media including HD DVD and Blu-ray Disc. Selected as an optional audio standard for both HD DVD and Blu-ray Disc, this technology delivers sound that is virtually indistinguishable from the original, offering a high-definition home theater experience. Supporting bitrates up to 3.0 Mbps for HD DVD and 6.0 Mbps for Blu-ray Disc, DTS-HD High Resolution Audio can carry up to 7.1 discrete channels of 24-bit/96 kHz audio simultaneously. Supported by HDMI version 1.3 and designed for the optical disc players and AV receivers/amplifiers of the future, DTS-HD High Resolution Audio also remains fully compatible with the existing multichannel audio systems that incorporate DTS Digital Surround.

■ DTS-HD Master Audio

DTS-HD Master Audio is an advanced lossless audio technology developed for high-definition disc-based media including HD DVD and Blu-ray Disc. Selected as a mandatory audio standard for both HD DVD and Blu-ray Disc, this technology delivers sound that is bit-for-bit identical to the studio master, offering a high-definition home theater experience. Supporting bitrates up to 18.0 Mbps for HD DVD and up to 24.5 Mbps for Blu-ray Disc, DTS-HD Master Audio can carry up to 7.1 discrete channels of 24-bit/96 kHz audio simultaneously. Supported by HDMI version 1.3 and designed for the optical disc players and AV receivers/amplifiers of the future, DTS-HD Master Audio also remains fully compatible with the existing multichannel audio systems that incorporate DTS Digital Surround.

■ HDMI

HDMI (High-Definition Multimedia Interface) is the first industry-supported, uncompressed, all-digital audio/video interface. Providing an interface between any source (such as a set-top box or AV receiver) and an audio/video monitor (such as a digital television), HDMI supports standard, enhanced or high-definition video as well as multi-channel digital audio using a single cable. HDMI transmits all ATSC HDTV standards and supports 8-channel digital audio, with bandwidth to spare to accommodate future enhancements and requirements. When used in combination with HDCP (High-bandwidth Digital Content Protection), HDMI provides a secure audio/video interface that meets the security requirements of content providers and system operators. For further information on HDMI, visit the HDMI website at “<http://www.hdmi.org/>”.

■ LFE 0.1 channel

This channel reproduces low-frequency signals. The frequency range of this channel is from 20 Hz to 120 Hz. This channel is counted as 0.1 because it only enforces a low-frequency range compared to the full-range reproduced by the other 5/6 channels in Dolby Digital or DTS 5.1/6.1-channel systems.

■ Neo:6

Neo:6 decodes the conventional 2-channel sources for 6-channel playback by the specific decoder. It enables playback with the full-range channels with higher separation just like digital discrete signal playback. There are two modes available: "Music mode" for music sources and "Cinema mode" for movie sources.

■ Neural Surround

Neural Surround™ represents the latest advancement in surround technology and has been adopted by XM Satellite Radio for digital radio broadcast of surround recordings and live events in surround sound. Neural Surround™ employs psychoacoustic frequency domain processing which allows delivery of a more detailed sound stage with superior channel separation and localization of audio elements. System playback is scalable from 5.1 to 7.1 multi-channel surround playback.

■ PCM (Linear PCM)

Linear PCM is a signal format under which an analog audio signal is digitized, recorded and transmitted without using any compression. This is used as a method of recording CDs and DVD audio. The PCM system uses a technique for sampling the size of the analog signal per very small unit of time. Standing for "Pulse Code Modulation", the analog signal is encoded as pulses and then modulated for recording.

■ Sampling frequency and number of quantized bits

When digitizing an analog audio signal, the number of times the signal is sampled per second is called the sampling frequency, while the degree of fineness when converting the sound level into a numeric value is called the number of quantized bits. The range of rates that can be played back is determined based on the sampling rate, while the dynamic range representing the sound level difference is determined by the number of quantized bits. In principle, the higher the sampling frequency, the wider the range of frequencies that can be played back, and the higher the number of quantized bits, the more finely the sound level can be reproduced.

■ SRS CS II (SRS Circle Surround II)

SRS CS II (SRS Circle Surround II) is a high-performance 6.1 channel matrix surround sound decoding system. It is the next-generation of the original SRS Circle Surround technology, incorporating powerful industry-first features including the dialog clarity enhancement technology and added cinema-like bass to the front channels and subwoofer.

■ S-video signal

With the S-video signal system, the video signal normally transmitted using a pin cable is separated and transmitted as the Y signal for the luminance and the C signal for the chrominance through the S-video cable. Using the S VIDEO jack eliminates video signal transmission loss and allows recording and playback of even more beautiful images.

■ "x.v.Color"

A color space standard supported by HDMI version 1.3. It is a more extensive color space than sRGB, and allows the expression of colors that could not be expressed before. While remaining compatible with the color gamut of sRGB standards, "x.v.Color" expands the color space and can thus produce more vivid, natural images. It is particularly effective for still pictures and computer graphics.

Sound field program information

■ Elements of a sound field

What really creates the rich, full tones of a live instrument are the multiple reflections from the walls of the room. In addition to making the sound live, these reflections enable us to tell where the player is situated as well as the size and shape of the room in which we are sitting.

There are two distinct types of sound reflections that combine to make up the sound field in addition to the direct sound coming straight to our ears from the player's instrument.

Early reflections

Reflected sounds reach our ears extremely rapidly (50 ms to 100 ms after the direct sound), after reflecting from one surface only (for example, from a wall or the ceiling).

Early reflections actually add clarity to the direct sound.

Reverberations

These are caused by reflections from more than one surface (for example, from the walls, and the ceiling) so numerous that they merge together to form a continuous sonic afterglow. They are non-directional and lessen the clarity of the direct sound.

Direct sound, early reflections and subsequent reverberations taken together help us to determine the subjective size and shape of the room, and it is this information that the digital sound field processor reproduces in order to create sound fields.

If you could create the appropriate early reflections and subsequent reverberations in your listening room, you would be able to create your own listening environment. The acoustics in your room could be changed to those of a concert hall, a dance floor, or a room with virtually any size at all. This ability to create sound fields at will is exactly what Yamaha has done with the digital sound field processor.

■ CINEMA DSP

Since the Dolby Surround and DTS systems were originally designed for use in movie theaters, their effect is best felt in a theater having many speakers designed for acoustic effects. Since home conditions, such as room size, wall material, number of speakers, and so on, can differ so widely, it is inevitable that there are differences in the sound heard. Based on a wealth of actually measured data, Yamaha CINEMA DSP uses Yamaha original sound field technology to combine Dolby Pro Logic, Dolby Digital and DTS systems to provide the audiovisual experience of a movie theater in the listening room of your own home.

■ SILENT CINEMA

Yamaha has developed a natural, realistic sound effect DSP algorithm for headphones. Parameters for headphones have been set for each sound field so that accurate representations of all the sound field programs can be enjoyed on headphones.

■ Virtual CINEMA DSP

Yamaha has developed a Virtual CINEMA DSP algorithm that allows you to enjoy DSP sound field surround effects even without any surround speakers by using virtual surround speakers. It is even possible to enjoy Virtual CINEMA DSP using a minimal two-speaker system that does not include a center speaker.

■ Compressed Music Enhancer

The Compressed Music Enhancer feature of this unit enhances your listening experience by regenerating the missing harmonics in a compression artifact. As a result, flattened complexity due to the loss of high-frequency fidelity as well as lack of bass due to the loss of low-frequency bass is compensated, providing improved performance of the overall sound system.

Specifications

AUDIO SECTION

- Minimum RMS Output Power for Front, Center, Surround, Surround back
1 kHz, 0.7% THD, 8 Ω 120 W
- Dynamic Power (IHF)
Front L/R, 8/6/4/2 Ω 140/175/205/250 W
- Maximum Output Power [Russia model]
Speaker impedance setting: 8 Ω, 1 kHz, 0.7% THD, 4 Ω 155 W
- Dynamic Headroom [U.S.A. and Canada models]
8 Ω 1.25 dB
- IEC Output Power [Russia model]
Front L/R, 1 kHz, 0.06% THD, 8 Ω 115 W
- Damping Factor (IHF)
Front L/R, SPEAKERS A, 20 Hz to 20 kHz, 8 Ω 120 or more
- Input Sensitivity/Input Impedance
PHONO (MM) 3.5 mV/47 kΩ
CD, etc. 200 mV/47 kΩ
MULTI CH INPUT 200 mV/47 kΩ
- Maximum Input Voltage
PHONO (MM)
1 kHz, 0.1% THD 60 mV or more
CD, etc.
Effect On, 1 kHz, 0.5% THD 2.3 V or more
- Rated Output Voltage/Output Impedance
OUT (REC) 200 mV/1.2 kΩ
PRE OUT 1.0 V/1.2 kΩ
SUBWOOFER (2ch Stereo, FRONT SP: SMALL)
..... 1.0 V/1.2 kΩ
ZONE 2 OUT 200 mV/1.2 kΩ
- Headphone Jack Rated Output/Impedance
CD, etc. (1 kHz, 50 mV, 8 Ω) 150 mV/100 Ω
- Frequency Response
CD to Front L/R, 10 Hz to 100 kHz
..... +0/-3 dB
- RIAA Equalization Deviation
PHONO (MM) 0 ± 0.5 dB
- Total Harmonic Distortion
PHONO (MM) to OUT (REC)
20 Hz to 20 kHz, 1 V 0.02% or less
CD, etc. to Front L/R
2ch Stereo, 20 Hz to 20 kHz, 50 W, 8 Ω 0.06% or less
- Signal to Noise Ratio (IHF-A Network)
PHONO (MM, 5 mV) to OUT (REC)
[Russia model] 81 dB or more
[Other models] 86 dB or more
CD, etc. (Effect Off, 250 mV) to Front L/R
..... 100 dB or more
- Residual Noise (IHF-A Network)
Front L/R 150 μV or less
- Channel Separation (1 kHz/10 kHz)
PHONO (shortened) to Front L/R 60 dB/55 dB or more
CD, etc. (5.1 kΩ shortened) to Front L/R
..... 60 dB/45 dB or more

- Volume Control MUTE/-80 dB to 16.5 dB
- Tone Control (Front L/R)
BASS Boost/Cut ±10 dB/50 Hz
BASS Turnover Frequency 350 Hz
TREBLE Boost/Cut ±10 dB/20 kHz
TREBLE Turnover Frequency 3.5 kHz
- Filter Characteristics (fc=40/60/80/90/100/110/120/160/200 Hz)
H.P.F.
(FRONT SP, CENTER SP, SUR. L/R SP, SUR.B L/R SP:
SMALL/SML) 12 dB/oct.
L.P.F. (Subwoofer) 24 dB/oct.

VIDEO SECTION

- Video Format (Gray Back)
[U.S.A. and Canada models] NTSC
[Russia model] PAL
- Video Format (Video Conversion) NTSC/PAL
- Signal Level
Composite 1 V_{p-p}/75 Ω
S-video 1 V_{p-p}/75 Ω (Y), 0.286 V_{p-p}/75 Ω (C)
Component 1 V_{p-p}/75 Ω (Y), 0.7 V_{p-p}/75 Ω (P_B/P_R)
- Maximum Input Level (Video Conversion Off)
..... 1.5 V_{p-p} or more
- Signal to Noise Ratio
..... 50 dB or more
- Frequency Response (MONITOR OUT)
Component (Video Conversion Off)
..... 5 Hz to 100 MHz, -3 dB

FM SECTION

- Tuning Range
[U.S.A. and Canada models] 87.5 to 107.9 MHz
[Russia model] 87.50 to 108.00 MHz
- 50 dB Quieting Sensitivity (IHF)
1 kHz, 100% MOD., Mono 2.8 μV (20.2 dBf)
- Signal to Noise Ratio (IHF)
Mono/Stereo 73 dB/70 dB
HD Radio (U.S.A. model) 80 dB
- Harmonic Distortion (1 kHz)
Mono/Stereo 0.5%
HD Radio (U.S.A. model) 0.03%
- Antenna Input (unbalanced) 75 Ω

AM SECTION

- Tuning Range
[U.S.A. and Canada models] 530 to 1710 kHz
[Russia model] 531 to 1611 kHz

GENERAL

- Power Supply
 - [U.S.A. and Canada models] AC 120 V, 60 Hz
 - [Russia model] AC 230 V, 50 Hz
- Power Consumption
 - [U.S.A. and Canada models] 400 W/500 VA
 - [Russia model] 440 W
- Standby Power Consumption
 - [U.S.A. and Canada models] 0.8 W or less
 - [Russia model] 0.1 W or less
- AC Outlets
 - [U.S.A., Canada, and China models] 2 (Total 100 W maximum)
 - [Russia model] 2 (Total 50 W maximum)
- Dimensions (W x H x D) 435 x 171 x 393 mm
(17-1/8 x 6-3/4 x 15-1/2 in)
- Weight 11.9 kg (26 lbs 4 oz)

* Specifications are subject to change without notice.

Index

■ Numerics

| | |
|--------------------------------------|----|
| 1 BASIC MENU, Manual setup | 82 |
| 2 VOLUME MENU, Manual setup | 83 |
| 2ch STEREO, Sound field program | 50 |
| 3 SOUND MENU, Manual setup | 83 |
| 4 INPUT MENU, Manual setup | 84 |
| 5 OPTION MENU, Manual setup | 84 |
| 7ch Enhancer, Sound field program | 50 |
| 7ch STEREO, Sound field program | 50 |
| 96/24 indicator | 30 |

■ A

| | |
|--|--------|
| A)DISPLAY SET, Option menu | 98 |
| A)EQUALIZER, Sound menu | 92 |
| A)SPEAKER SET, Basic menu | 87 |
| AC OUTLETS (SWITCHED) | 28 |
| ACQUIRING, SIRIUS Satellite Radio status message | 118 |
| Action Game, Sound field program | 49 |
| ADAPTIVE DRC indicator | 30 |
| ADAPTIVE DRC, Volume menu | 91 |
| ADAPTIVE DSP LEVEL, Volume menu | 91 |
| Adaptive DSP level, Volume menu | 91 |
| Adaptive dynamic range control, Volume menu | 91 |
| Advanced setup | 109 |
| Advanced sound configurations | 74 |
| Adventure, Sound field program | 50 |
| ALL CH SEARCH, SIRIUS tuning | 66 |
| ALL CH SEARCH, XM tuning | 61 |
| All Channel Search mode, XM tuning | 61, 66 |
| All remote control codes resetting | 104 |
| AM antenna connection | 27 |
| AM tuning | 53 |
| Amplifier function OSD display time, Display settings | 98 |
| ANTENNA ERROR, SIRIUS Satellite Radio status message | 118 |
| Audio and video synchronization, Sound menu | 94 |
| Audio cable plugs | 17 |
| Audio components connection | 23 |
| Audio information | 46 |
| Audio input jacks selection | 44 |
| AUDIO jacks | 17 |
| Audio jacks | 17 |
| AUDIO SELECT | 44 |
| AUDIO SELECT, Initial configuration | 100 |
| Audio select, Initial configuration | 100 |
| Audio signal flow | 19 |
| Auto delay, Lip sync | 94 |

| | |
|---|--------|
| AUTO SETUP | 32, 82 |
| Auto setup | 82 |
| AUTO SETUP, Troubleshooting | 120 |
| AUTO TUNING | 53 |
| AUTO, Lip sync | 94 |
| Automatic tuning mode, FM/AM tuning | 53 |
| Available decoders with Sound field programs | 79 |

■ B

| | |
|---|-----|
| B)LFE LEVEL, Sound menu | 93 |
| B)SP LEVEL, Basic menu | 89 |
| B)VIDEO SET, Option menu | 98 |
| BASIC MENU, Manual setup | 87 |
| Basic menu, Manual setup | 82 |
| Basic SIRIUS Satellite Radio operation | 65 |
| Bass cross over, Speaker settings | 89 |
| BGV, Input menu | 97 |
| BI-AMP, Advanced setup | 112 |
| Bi-Amplifier, Advanced setup | 112 |
| Bluetooth adapter connection | 25 |
| Bluetooth component playback | 72 |
| Bluetooth component use | 72 |
| Bluetooth, Troubleshooting | 119 |
| BT connected, Bluetooth status message | 119 |

■ C

| | |
|--|-----|
| C)DYNAMIC RANGE, Sound menu | 93 |
| C)MEMORY GUARD, Option menu | 100 |
| C)SP DISTANCE, Basic menu | 90 |
| C. IMAGE, Decoder parameter | 81 |
| Cable plugs | 17 |
| CALL SIRIUS, SIRIUS Satellite Radio status message | 118 |
| Canceled, Troubleshooting | 119 |
| CAT SEARCH, SIRIUS tuning | 66 |
| CAT SEARCH, XM tuning | 61 |
| Category Search mode, SIRIUS tuning | 66 |
| CD player connection | 23 |
| Cellar Club, Sound field program | 49 |
| CENTER PRE OUT jack connection | 24 |
| CENTER SP, Speaker settings | 88 |
| Center speaker level, Sound field parameter | 79 |
| Center speaker, Speaker settings | 88 |
| CENTER WIDTH, Decoder parameter | 81 |
| CH UNAUTH, XM Satellite Radio status message | 117 |
| CH UNAVAIL, XM Satellite Radio status message | 117 |
| Chamber, Sound field program | 48 |

| | |
|--|-----|
| Charge on standby, Input menu | 96 |
| CHECK ANTENNA, XM Satellite Radio status message | 117 |
| CHECK PRNS, Automatic setup warning message | 121 |
| CHECK SR TUNER, SIRIUS Satellite Radio status message | 118 |
| CHECK SUR., Automatic setup error message | 120 |
| CHECK XM TUNER, XM Satellite Radio status message | 117 |
| CINEMA DSP indicator | 31 |
| CLASSICAL, Sound field category | 48 |
| Completed, Bluetooth status message | 119 |
| COMPONENT VIDEO jacks | 17 |
| Compressed Music Enhancer | 50 |
| Connect error, iPod status message | 119 |
| Connect MIC!, Automatic setup error message | 120 |
| Connection, AM antenna connection | 27 |
| Connection, audio components | 23 |
| Connection, Bluetooth adapter | 25 |
| Connection, CD player | 23 |
| Connection, CENTER PRE OUT jack | 24 |
| Connection, DVD player | 21 |
| Connection, DVD recorder | 22 |
| Connection, External amplifier | 24 |
| Connection, external decoder | 25 |
| Connection, FM antenna | 27 |
| Connection, FRONT PRE OUT jacks | 24 |
| Connection, iPod universal dock | 25 |
| Connection, Multi-format player | 25 |
| Connection, Power cable | 28 |
| Connection, projector | 20 |
| Connection, PVR | 22 |
| Connection, set-top boxes | 22 |
| Connection, SiriusConnect tuner | 64 |
| Connection, speaker cable | 16 |
| Connection, SUBWOOFER PRE OUT jack | 24 |
| Connection, SUR.BACK PRE OUT jacks | 24 |
| Connection, SURROUND PRE OUT jacks | 24 |
| Connection, Turntable | 23 |
| Connection, TV monitor | 20 |
| Connection, VCR | 22 |
| Connection, XM Mini-Tuner Dock | 59 |
| CROSS OVER, Speaker settings | 89 |
| CSII Cinema, Decoder type | 80 |
| CSII Music, Decoder type | 80 |
| CT LEVEL, Sound field parameter | 79 |
| Current status display | 44 |

■ D

| | |
|---------------------------------|-----|
| D)INIT. CONFIG, Option menu | 100 |
| D)LIPSYNC, Sound menu | 94 |
| D)TEST TONE, Basic menu | 90 |
| Decoder descriptions | 80 |
| Decoder indicators | 30 |
| DECODER MODE, | |
| Initial configuration | 100 |
| Decoder mode, | |
| Initial configuration | 100 |
| DECODER MODE, Input menu | 96 |
| Decoder mode, Input menu | 96 |
| Decoder selection | 79 |
| DEVICE OVER, | |
| HDMI error message | 46 |
| DIALG.LIFT, | |
| Sound field parameter | 75 |
| Dialogue lift, | |
| Sound field parameter | 75 |
| DIGITAL COAXIAL jacks | 17 |
| DIGITAL OPTICAL jacks | 17 |
| DIMENSION, Decoder parameter | 81 |
| DIMMER, Display settings | 98 |
| Dimmer, Display settings | 98 |
| Direct number access mode, | |
| SIRIUS tuning | 66 |
| Direct number access mode, | |
| XM tuning | 61 |
| DIRECT, Sound field parameter | 79 |
| Disconnected, | |
| Bluetooth status message | 119 |
| Disconnected, | |
| iPod status message | 119 |
| Display settings, Option menu | 98 |
| Displaying HD Radio information | 58 |
| DIST, Auto setup result | 34 |
| DOCK indicator | 30 |
| Drama, Sound field program | 50 |
| DSP effect sound level, | |
| Sound field parameter | 75 |
| DSP indicators | 31 |
| DSP LEVEL, | |
| Sound field parameter | 75 |
| DVD player connection | 21 |
| DVD recorder connection | 22 |
| Dynamic range, Sound menu | 93 |

■ E

| | |
|--|-----|
| E)EXTD SUR., Sound menu | 94 |
| E)HDMI SET, Option menu | 101 |
| E-1:NO FRONT SP, Automatic setup error message | 120 |
| E-10:INTERNAL ERROR, Automatic setup error message | 120 |
| E-2:NO SUR SP, Automatic setup error message | 120 |
| E-3:NO PRNS SP, Automatic setup error message | 120 |
| E-4:SBR->SBL, Automatic setup error message | 120 |
| E-5:NOISY, Automatic setup error message | 120 |
| E-6:CHECK SUR., Automatic setup error message | 120 |

| | |
|--|-----|
| E-7:NO MIC, Automatic setup error message | 120 |
| E-8:NO SIGNAL, Automatic setup error message | 120 |
| E-9:USER CANCEL, Automatic setup error message | 120 |
| EFFECT LEVEL, | |
| Sound field parameter | 79 |
| ENHANCER indicator | 30 |
| ENTERTAINMENT, | |
| Sound field category | 49 |
| EQ TYPE SELECT, Equalizer | 92 |
| EQ, Auto setup parameter | 33 |
| Equalizer type select, Equalizer | 92 |
| Equalizer, Sound menu | 92 |
| EXTD SUR., Initial configuration | 100 |
| Extended surround, | |
| Initial configuration | 100 |
| Extended surround, Sound menu | 94 |
| External amplifier connection | 24 |
| External decoder connection | 25 |
| EXTRA SP ASSIGN, Auto setup parameter | 33 |
| EXTRA SP ASSIGN, | |
| Speaker settings | 87 |
| Extra speaker assignment, | |
| Auto setup parameter | 33 |
| Extra speaker assignment, | |
| Speaker settings | 87 |

■ F

| | |
|---|-----|
| F)ZONE2 SET, Option menu | 101 |
| F/W UPDATING, SIRIUS Satellite Radio status message | 118 |
| FL SCROLL, Display settings | 98 |
| FM antenna | 27 |
| FM antenna connection | 27 |
| FM tuning | 53 |
| FOCUS | 81 |
| Front input, Input menu | 97 |
| Front panel display | 30 |
| Front panel display scroll, | |
| Display settings | 98 |
| FRONT PRE OUT jack connection | 24 |
| FRONT SP, Speaker settings | 88 |
| Front speaker set selection | 43 |
| Front speakers, Speaker settings | 88 |
| FRONT, Input menu | 97 |

■ G

| | |
|------------------------------|----|
| GEQ, Equalizer | 92 |
| Graphic equalizer, Equalizer | 92 |

■ H

| | |
|------------------------------|-----|
| Hall in Munich, | |
| Sound field program | 48 |
| Hall in Vienna, | |
| Sound field program | 48 |
| HD Radio | 57 |
| HD Radio information display | 58 |
| HD Radio, Troubleshooting | 116 |
| HDCP ERROR, | |
| HDMI error message | 46 |

| | |
|---------------------------------|-----|
| HDMI | 18 |
| HDMI ASPECT | 99 |
| HDMI aspect ratio | 99 |
| HDMI AUTO, Lip sync | 94 |
| HDMI auto, Lip sync | 94 |
| HDMI indicator | 30 |
| HDMI RES., Video settings | 99 |
| HDMI resolution, Video settings | 99 |
| HDMI set, Option menu | 101 |
| HDMI, troubleshooting | 115 |
| HEADPHONE, Dynamic range | 93 |
| HEADPHONE, | |
| Low frequency effect level | 93 |
| Headphones | 45 |
| Headphones indicator | 30 |
| Headphones, Dynamic range | 93 |
| Headphones, | |
| Low frequency effect level | 93 |

■ I

| | |
|--|-----|
| I/O ASSIGNMENT, Input menu | 95 |
| Infrared window | 31 |
| INI.VOL., Zone 2 settings | 101 |
| INIT, Advanced setup | 112 |
| INIT.DLY, | |
| Sound field parameter | 76 |
| INIT.VOL., Volume menu | 91 |
| Initial configuration, | |
| Option menu | 100 |
| Initial delay, | |
| Sound field parameter | 76 |
| INTERNAL ERROR, Automatic setup error message | 120 |
| Initial volume, Volume menu | 91 |
| INPUT CH, Input menu | 97 |
| Input channel and speaker indicators | 31 |
| Input channel indicators | 31 |
| Input channels, Input menu | 97 |
| INPUT MENU, Manual setup | 95 |
| Input menu, Manual setup | 84 |
| INPUT RENAME, Input menu | 96 |
| Input rename, Input menu | 96 |
| Input signal indicators | 30 |
| Input source indicators | 30 |
| Input source information display | 46 |
| Input/output assignment, | |
| Input menu | 95 |
| INVALID, SIRIUS Satellite Radio status message | 118 |
| iPod universal dock connection | 25 |
| iPod use | 70 |
| iPod, Troubleshooting | 119 |

■ J

| | |
|-------|----|
| Jacks | 17 |
|-------|----|

■ L

| | |
|--|-----|
| LEVEL ERROR, Automatic setup warning message | 121 |
| LFE/BASS OUT, Speaker settings | 87 |
| LFE/Bass out, Speaker settings | 87 |
| Lip Sync, Sound menu | 94 |

- LIVE/CLUB,
 Sound field category 49
- LIVENESS, Sound field parameter 77
- Liveness, Sound field parameter 77
- LOADING, XM Satellite Radio status
 message 117
- Loading..., iPod status message 119
- Low-frequency effect level,
 Sound menu 93
- LVL, Auto setup result 34
- M**
- Manual delay, Lip sync 94
- MANUAL SETUP 82
- Manual setup 82
- MANUAL TUNING 53
- Manual tuning mode,
 FM/AM tuning 53
- MANUAL, Lip sync 94
- MAX VOL., Volume menu 91
- MAX VOL., Zone 2 settings 101
- Maximum volume, Volume menu 91
- Memory Guard!, Automatic setup
 error message 120
- Memory guard, Option menu 100
- MON.CHK, Advanced setup 112
- Monitor check, Advanced setup 112
- Mono Movie, Sound field program 50
- MOVIE, Sound field category 49
- MULTI CH INPUT component
 selection 43
- MULTI CH INPUT jacks 25
- Multi-channel input BGV, Input menu,
 BGV, Input menu 97
- Multi-channel source playback
 with headphones 51
- Multi-format player connection 25
- Multi-information display 31
- MULTI-ZONE Configuration 106
- MUSIC ENHANCER,
 Sound field category 50
- Music Video,
 Sound field program 49
- MUTE 45
- MUTE indicator 30
- Muting 45
- N**
- Neo:6 Cinema, Decoder type 79, 80
- Neo:6 Music, Decoder type 80
- Neural Sur., Decoder type 80
- No BT Adapter, Bluetooth status
 message 119
- NO FRONT SP, Automatic setup
 error message 120
- NO MIC, Automatic setup
 error message 120
- NO PRNS SP, Automatic setup
 error message 120
- NO SIGNAL, Automatic setup
 error message 120
- NO SIGNAL, XM Satellite Radio
 status message 117
- NO SUR SP, Automatic setup
 error message 120
- NOISY, Automatic setup
 error message 120
- Not Available, SIRIUS Satellite Radio
 status message 118
- NOT SUPPORTED, SIRIUS Satellite
 Radio status message 118
- Number of speakers,
 Auto setup result 34
- O**
- OFF AIR, XM Satellite Radio status
 message 117
- Operation mode selector 31
- OPTIMIZER MIC jack 32
- OPTION MENU, Manual setup 98
- Option menu, Manual setup 84
- OSD SHIFT, Display settings 98
- OSD shift, Display settings 98
- OSD-AMP, Display settings 98
- OSD-SOURCE, Display settings 98
- Other components controlling
 by remote control 103
- Other components controlling,
 Remote control 103
- OUT OF PHASE, Automatic setup
 warning message 121
- Out of Res., HDMI message 46
- OVER 24m (80ft), Automatic setup
 warning message 121
- P**
- P.INIT.DLY,
 Sound field parameter 76
- P.ROOM SIZE,
 Sound field parameter 77
- Pairing, Bluetooth operation 72
- PANORAMA, Decoder parameter 81
- Parameter initialization,
 Advanced setup 112
- Parametric equalizer type,
 Auto setup parameter 33
- Parental Lock 67
- Parental Lock 67
- PARENTAL LOCK, Input menu 68
- PHONES jack 45
- PL LEVEL, Sound field parameter 79
- Playing video sources
 in the background 45
- PLII Game, Decoder type 80
- PLII Movie, Decoder type 79, 80
- PLII Music, Decoder type 80
- PLIIX Game, Decoder type 80
- PLIIX Movie, Decoder type 79, 80
- PLIIX Music, Decoder type 80
- Power cable connection 28
- PR LEVEL,
 Sound field parameter 79
- Presence left speaker level,
 Sound field parameter 79
- Presence right speaker level,
 Sound field parameter 79
- Presence sound field initial delay, Sound
 field parameter 76
- Presence sound field room size, Sound
 field parameter 77
- Presence speaker indicators 31
- Presence speaker using 13
- Preset channel setting,
 XM tuning 62, 67
- Preset SCENE templates 39
- Preset Search mode,
 SIRIUS tuning 66
- Preset Search mode, XM tuning 61
- PRESET SEARCH, SIRIUS tuning 66
- PRESET SEARCH, XM tuning 61
- PRESET TUNING 53
- Preset tuning mode,
 FM/AM tuning 53
- Pro Logic, Decoder type 80
- Projector connection 20
- Pure Direct 52
- Pure hi-fi sound 52
- PVR connection 22
- R**
- Rear panel 10
- REMOTE AMP, Advanced setup 110
- Remote control AMP ID,
 Advanced setup 110
- Remote control code
 default settings 104
- Remote control codes iii
- Remote control codes setting 104
- Remote control SIRIUS ID,
 Advanced setup 111
- Remote control TUNER ID,
 Advanced setup 110
- Remote control XM ID,
 Advanced setup 111
- REMOTE IN/OUT jacks 26
- REMOTE SR, Advanced setup 111
- REMOTE TU, Advanced setup 110
- REMOTE XM, Advanced setup 111
- Rename, SCENE template 40
- Repeat 71
- Repeat, iPod playback 71
- Resetting the system 122
- REV.DELAY,
 Sound field parameter 78
- REV.LEVEL,
 Sound field parameter 78
- REV.TIME,
 Sound field parameter 78
- Reverberation delay,
 Sound field parameter 78
- Reverberation level,
 Sound field parameter 78
- Reverberation time,
 Sound field parameter 78
- Roleplaying Game,
 Sound field program 49
- ROOM SIZE,
 Sound field parameter 77
- Room size,
 Sound field parameter 77

■ S

- S VIDEO jacks 17
- S.Audio, HDMI set 101
- S.INIT.DLY,
 - Sound field parameter 76
- S.LIVENESS,
 - Sound field parameter 77
- S.ROOM SIZE,
 - Sound field parameter 77
- SB INI.DLY,
 - Sound field parameter 76
- SB LEVEL,
 - Sound field parameter 79
- SB LIVENESS,
 - Sound field parameter 77
- SB ROOM SIZE,
 - Sound field parameter 77
- SBR->SBL, Automatic setup error message 120
- SCENE 1 8
- SCENE 2 8
- SCENE 3 8
- SCENE 4 8
- SCENE IR code setting,
 - Advanced setup 112
- SCENE IR, Advanced setup 112
- SCENE template rename 40
- Sci-Fi, Sound field program 49
- Searching...,
 - Bluetooth status message 119
- Selecting
 - HD Radio audio programs 57
- Selection, Audio input jacks 44
- Selection, Front speaker set 43
- Selection,
 - MULTI CH INPUT component 43
- Selection, SCENE template 37
- SET MENU usage 86
- Set-top box connection 22
- Shuffle, iPod playback 71
- SIGNAL INFO 46
- Signal information 85
- SILENT CINEMA 51
- SILENT CINEMA indicator 31
- SIRIUS ID 65
- SIRIUS Parental Lock personal identification number reset,
 - Advanced setup 112
- SIRIUS Satellite Radio 64
- SIRIUS Satellite Radio activation 65
- SIRIUS Satellite Radio Parental Lock,
 - Input menu 68
- SIRIUS Satellite Radio,
 - Troubleshooting 118
- SiriusConnect tuner
 - connection 64
- SL LEVEL,
 - Sound field parameter 79
- SLEEP indicator 31
- Sleep timer 47
- Sound field indicators 30
- Sound field parameter changing 74
- Sound field programs 48
 - Sound field programs
 - with headphones 51
- Sound field programs
 - without surround speakers 51
- SOUND MENU, Manual setup 92
- Sound menu, Manual setup 83
- Source feature OSD display time,
 - Display settings 98
- SP A B indicators 31
- SP IMP., Advanced setup 109
- SP, Auto setup result 34
- Speaker cable connection 16
- Speaker distance,
 - Auto setup result 34
- Speaker distance,
 - Basic menu 90
- Speaker distances 90
- Speaker impedance setting 28
- Speaker impedance,
 - Advanced setup 109
- Speaker level adjustment 52
- Speaker level, Auto setup result 34
- Speaker level, Basic menu 89
- Speaker settings, Basic menu 87
- SPEAKER, Dynamic range 93
- SPEAKER,
 - Low frequency effect level 93
- Speakers, Dynamic range 93
- Speakers,
 - Low frequency effect level 93
- Specifications 127
- Spectacle, Sound field program 49
- Sports, Sound field program 49
- SR LEVEL,
 - Sound field parameter 79
- SR PIN, Advanced setup 112
- Standard, Sound field program 49
- STANDBY CHARGE,
 - Input menu 96
- Standby mode, Main zone 29
- Standby mode, Zone 2 108
- START PAIRING, Input menu 97
- STEREO, Sound field category 50
- Straight 51
- Straight Enhancer,
 - Sound field program 50
- STRAIGHT mode 51
- SUB UPDATED, SIRIUS Satellite Radio status message 118
- SUBWOOFER PHASE,
 - Speaker settings 89
- Subwoofer phase, Speaker settings 89
- SUBWOOFER PRE OUT jack
 - connection 24
- Supplied accessories 2
- Support audio, HDMI set 101
- SUR. L/R SP, Speaker settings 88
- SUR.B L/R SP, Speaker settings 88
- SUR.BACK PRE OUT jack
 - connection 24
- Surround back left/right speakers,
 - Speaker settings 88
- Surround back sound field initial delay,
 - Sound field parameter 76
- Surround back sound field liveness,
 - Sound field parameter 77
- Surround back sound field room size,
 - Sound field parameter 77
- Surround back speaker level,
 - Sound field parameter 79
- Surround decode mode 79
- Surround left speaker level,
 - Sound field parameter 79
- Surround left/right speakers,
 - Speaker settings 88
- SURROUND PRE OUT jack
 - connection 24
- Surround right speaker level,
 - Sound field parameter 79
- Surround sound field initial delay,
 - Sound field parameter 76
- Surround sound field liveness,
 - Sound field parameter 77
- Surround sound field room size,
 - Sound field parameter 77
- SYSTEM OFF 29

■ T

- Test tone, Basic menu 90
- Test tone, Equalizer 92
- TEST, Equalizer 92
- The Bottom Line,
 - Sound field program 49
- The Roxy Theatre,
 - Sound field program 49
- Tonal quality adjustment 52
- TRANSMIT indicator 31
- Troubleshooting 113
- TruBass 81
- Tuner indicators 30
- Tuner, Troubleshooting 116
- Turning off 29
- Turning on 29
- Turntable connection 23
- TV Controlling, remote control 102
- TV monitor connection 20

■ U

- Unable to play,
 - iPod status message 119
- UNIT, Speaker distance 90
- Unit, Speaker distance 90
- Unknown iPod,
 - iPod status message 119
- Unplug HP!, Automatic setup error message 120
- Unprocessed input sources 51
- UPDATING, SIRIUS Satellite Radio status message 118
- USER CANCEL,
 - Automatic setup error message 120

■ V

- VCR connection 22
- VIDEO AUX jacks 26
- VIDEO CONV.,
 - Video settings 98

| | |
|---------------------------------------|----|
| Video conversion, | |
| Video settings | 98 |
| Video information | 46 |
| VIDEO jacks | 17 |
| Video jacks | 17 |
| Video signal flow | 19 |
| Video sources in the background | 45 |
| Virtual CINEMA DSP | 51 |
| VIRTUAL indicator | 31 |
| VOL. TRIM, Input menu | 96 |
| VOLUME level indicator | 30 |
| Volume menu, Manual setup | 83 |
| Volume Trim, Input menu | 96 |

■ W

| | |
|---|-----|
| W-1:OUT OF PHASE, Automatic setup warning message | 121 |
| W-2:OVER 24m (80ft), Automatic setup warning message | 121 |
| W-3:LEVEL ERROR, Automatic setup warning message | 121 |
| W-4:CHECK PRNS, Automatic setup warning message | 121 |

■ X

| | |
|-------------------------------------|-----|
| XM Mini-Tuner Dock | 59 |
| XM Mini-Tuner Dock connection | 59 |
| XM satellite radio activation | 60 |
| XM Satellite Radio display | 63 |
| XM satellite radio tuning | 59 |
| XM Satellite Radio, | |
| Troubleshooting | 117 |
| XM Satellite Radio | 59 |

■ Y

| | |
|----------------------|----|
| YPAO indicator | 30 |
|----------------------|----|

■ Z

| | |
|------------------------------------|-----|
| Zone 2 | 106 |
| Zone 2 Initial volume, | |
| Zone 2 settings | 101 |
| Zone 2 Maximum volume, | |
| Zone 2 settings | 101 |
| Zone 2 settings, Option menu | 101 |
| Zone B | 43 |
| ZONE2 indicator | 31 |

“(A)SPEAKERS” or “(4)DVD”
(example) indicates the name of
the parts on the front panel or the
remote control. Refer to the
attached sheet or the pages at the
end of this manual for the
information about each position of
the parts.

■ Front panel

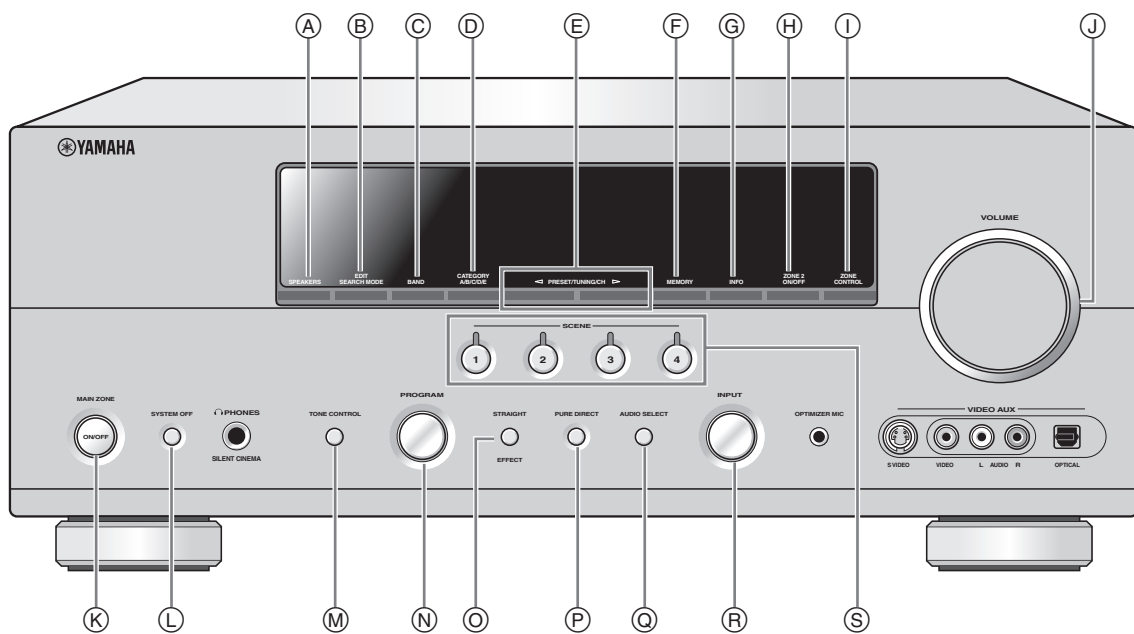

■ Remote control

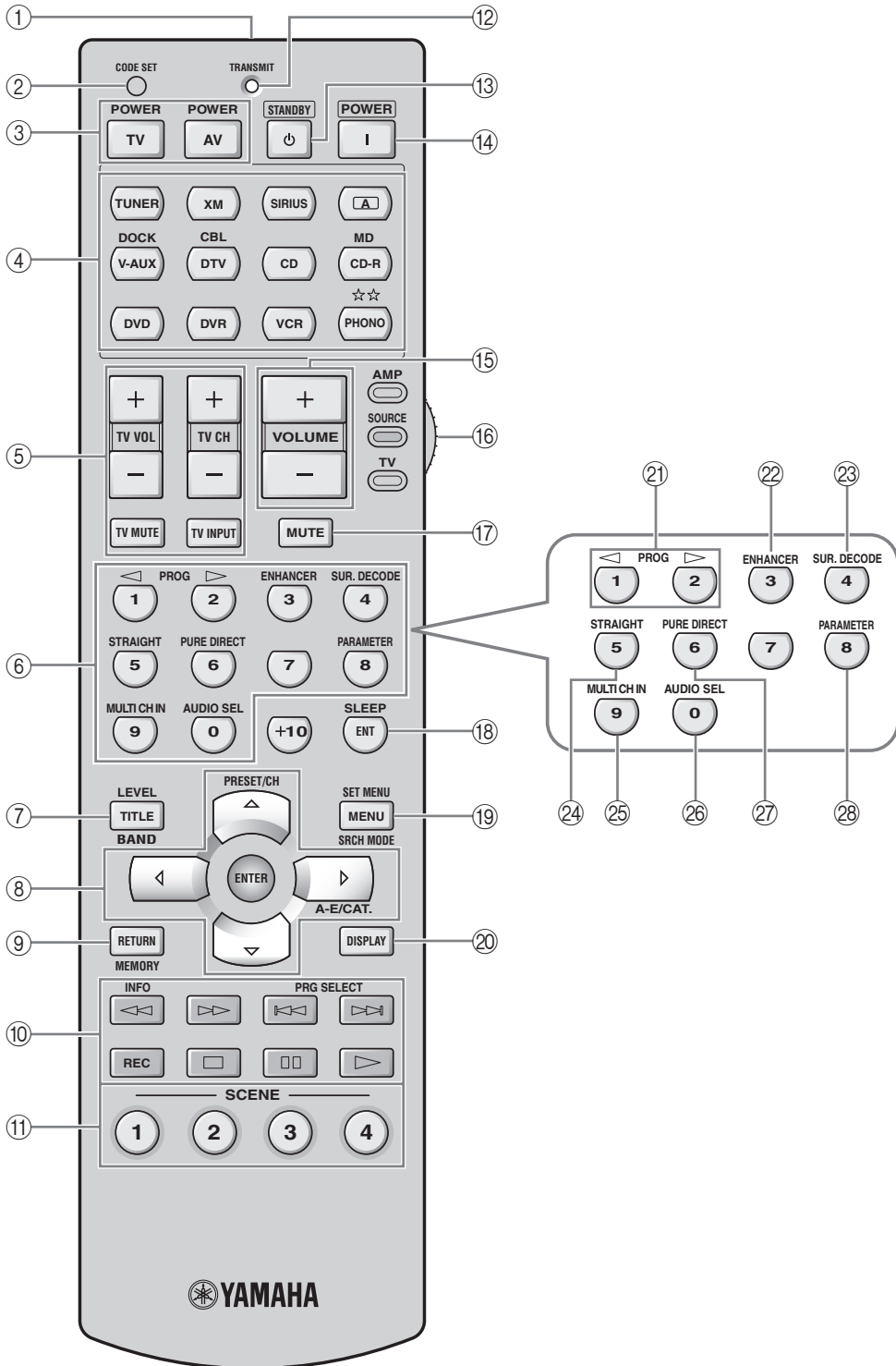

List of remote control codes

CABLE TV RECEIVER

3M 10033
 A-MARK 10008, 10144
 ABC 10003, 10007, 10008, 10011, 10014, 10033, 10237
 ACCUPHASE 10003, 10007, 10011, 10014
 ACORN 10237
 ACTION 10237
 ACTIVE 10237
 AICHI DENSHI 11512
 AMERICAST 10899
 AMINO 11602, 11822
 ARCHER 10237
 BCC 10276
 BELL & HOWELL 10014
 BELL SOUTH 10899
 BRITISH TELECOM 10003
 CENTURY 10008
 CLEARMASTER 10883
 CLEARMAX 10883
 COMTRONICS 10040
 COOL BOX 10883
 COOLMAX 10883
 DIGEO 11187
 DIGI 10637
 DIRECTOR 10476
 DUMONT 10637
 DX ANTENNA 11500, 11502
 EMERSON 10014
 EVERQUEST 10040
 FOSGATE 10276
 FUJITSU 11497
 GC ELECTRONICS 10040
 GE 10144
 GENERAL INSTRUMENT 10003, 10011, 10012, 10014, 10276, 10476, 10810
 GIBRALTER 10003
 GMI 10883
 GOLDSTAR 10040, 10144
 HAMLIN 10009, 10259, 10273
 HITACHI 10003, 10008, 10009, 10011, 10033
 HOUSTON 10011
 HYTEK 10007
 HYTEX 11602
 I3 MICRO 10476, 10810
 INSIGHT 10014
 JEBSEE 10003, 10011, 10012, 10014, 10276, 10476, 10810
 MACOM 10033
 MASPRO 11510
 MEMOREX 10000
 MITSUBISHI 10003

MOTOROLA 10014, 10276, 10476, 10810, 11106, 11187, 11254, 11376
 MULTITECH 10883
 MYRIO 11602, 11822
 NEC 11496
 NOVA VISION 10008
 NOVAPLEX 10008
 NSC 10012, 10637
 OAK 10007
 PACE 10008, 10237, 10877, 11877
 PANASONIC 10000, 10008, 10107, 10144, 10375, 11488, 11758, 11759, 11760, 11936, 11937, 11938
 PANTHER 10637
 PARAGON 10000, 10008, 10525
 PENNEY 10000, 10637
 PHILIPS 10259, 10317, 11305
 PIONEER 10144, 10533, 10877, 11021, 11500, 11782, 11877
 PRISM 10012
 PULSAR 10000, 10040
 PULSER 10040
 QUASAR 10000
 R-LINE 10040
 RADIOSHACK 10883
 RCA 11256
 REGAL 10259, 10273, 10276, 10279
 REMBRANDT 10011, 10040
 RUNCO 10000
 SAMSUNG 10003, 10040, 10144
 SCIENTIFIC ATLANTA 10000, 10003, 10008, 10012, 10237, 10477, 10877, 11510, 11877
 SEJIN 11602
 SIGNAL 10011, 10040
 SIGNATURE 10011
 SL MARX 10040
 SONY 11006, 11460
 SPRUCER 10144
 STARCOM 10003, 10014
 STARGATE 10014, 10040
 STORM 10637
 SUMITOMO 11500, 11503, 11504
 SUPERCABLE 10276
 SUPERMAX 10883
 TELEAVIA 10040
 TELEVIEW 10040
 THOMSON 11256
 TIMELESS 10040
 TOCOM 10012
 TORX 10003
 TOSHIBA 10000, 11509
 TRISTAR 10883
 TV86 10040

UNITED ARTISTS 10007
 UNITED CABLE 10003, 10011, 10014, 10276
 US ELECTRONICS 10003, 10008, 10276
 V2 10883
 VIDEOWAY 10000
 VIEWMASTER 10883
 VISION 10883
 VORTEX VIEW 10883
 ZENITH 10000, 10525, 10899

ZENITH 11810

SATELLITE RECEIVER

AIWA 11514, 11515
 ALPHASTAR 10772
 AMSTRAD 10338
 AUSTAR 10879
 BELL EXPRESSVU 10775, 11170
 CHAPARRAL 10216
 COOLSAT 11806
 CROSSDIGITAL 11109
 DIRECTV 10099, 10247, 10392, 10566, 10639, 10724, 10749, 10819, 11076, 11108, 11109, 11142, 11377, 11392, 11414, 11442, 11443, 11444, 11609, 11639, 11640, 11749, 11856
 DISH NETWORK SYSTEM 10775, 11005, 11170, 11505, 11775
 DISHPRO 10775, 11005, 11505, 11775
 DX ANTENNA 11530
 ECHOSTAR 10775, 11005, 11170, 11505, 11775
 ESAT 10879
 EXPRESSVU 10775, 11775
 FORTEC STAR 11821, 11948
 FOXTEL 10879, 11356
 FUNAI 10338, 11377
 GE 10392, 10566
 GENERAL INSTRUMENT 10869
 GOI 10775, 11775
 GOODMANS 11246
 HISENSE 11535
 HITACHI 10214, 10749, 10819, 11250, 11518, 11523, 11525
 HOUSTON 10775
 HTS 10775, 11775
 HUGHES NETWORK SYSTEMS 10749, 11142, 11442, 11443, 11444, 11749
 HUMAX 11781, 11790
 ILO 11535
 INNOVA 10099
 JERROLD 10869
 JVC 10492, 10775, 11170, 11507, 11531, 11532, 11775, 11793, 11797
 LG 11226, 11414
 MAGNAVOX 10722, 10724
 MASPRO 11520, 11530
 MATSUSHITA 10214
 MCINTOSH 10869

CABLE/PVR COMBINATION

AMERICAST 10899
 AMINO 11822
 DIGEO 11187
 GENERAL INSTRUMENT 10810
 JERROLD 10810
 MOTOROLA 10810, 11106, 11187, 11376
 MYRIO 11822
 PACE 10237, 11877
 PIONEER 10877, 11877
 RCA 11256
 SCIENTIFIC ATLANTA 10877, 11877
 SONY 11006
 SUPERCABLE 10276
 THOMSON 11256
 ZENITH 10899

DBS/PVR COMBINATION

BELL EXPRESSVU 10775, 11170
 DIRECTV 10099, 10392, 10639, 11076, 11142, 11377, 11392, 11442, 11443, 11444, 11640
 DISH NETWORK SYSTEM 10775, 11505
 DISHPRO 10775, 11505
 ECHOSTAR 10775, 11170, 11505
 EXPRESSVU 10775
 HUGHES NETWORK SYSTEMS 11142, 11442, 11443, 11444
 JVC 11170
 MOTOROLA 10869
 PHILIPS 11142, 11442
 PROSCAN 10392
 RCA 11392
 SAMSUNG 11442
 SHARP 11489
 SONY 10639, 11640
 STAR CHOICE 10869
 TIVO 11142, 11442, 11443, 11444

| | | | | | | | |
|-------------|---------------|----------------|---------------|----------------------|---------------|-----------------|---------------|
| MEMOREX | 10724 | ADMIRAL | 20017, 20047, | CAPEHART | 20017, 20030, | ELECTROBAND | |
| MITSUBISHI | 10749 | | 20051, 20054, | | 20036, 20092, | | 20000 |
| MOTOROLA | 10856, 10869 | | 20093, 20179, | | 20178 | ELECTROGRAPH | |
| NEC | 10496, 11270, | | 20180, 20264, | CARNIVALE | 20030 | | 21623, 21755 |
| | 11519 | | 20463 | CARVER | 20054, 20170 | ELECTROHOME | |
| NETSAT | 10099 | ADVENT | 20761, 20783, | CASIO | 21205 | | 20000, 20030, |
| NEXT LEVEL | 10869 | | 20815, 20817, | CCE | 20037 | | 20150, 20154, |
| OPTIMUS | 10724 | | 20842 | CELEBRITY | 20000 | | 20178, 20463, |
| OPTUS | 11356 | ADVENTURI | 20000 | CELERA | 20765 | | 21672 |
| PACE | 11356 | AGNA | 20150 | CHAMPION | 21362 | EMERALD | 20178 |
| PANASAT | 10879 | AIKO | 20092 | CHANGHONG | 20156, 20765, | EMERSON | 20036, 20047, |
| PANASONIC | 10214, 10247, | AIWA | 21180 | | 20767, 20783 | | 20150, 20154, |
| | 10701, 11508, | AKAI | 20030, 20060, | CINERAL | 20092, 20451 | | 20170, 20171, |
| | 11526, 11527, | | 20145, 20672, | CITEK | 20047 | | 20178, 20179, |
| | 11528 | | 20702, 20812, | CITIZEN | 20000, 20030, | | 20180, 20236, |
| PANSAT | 11807 | | 21207, 21675, | | 20054, 20060, | | 20451, 20463, |
| PAYSAT | 10724 | ALARON | 21676, 21688, | | 20092, 20171, | | 20623, 21394 |
| PHILIPS | 10099, 10722, | | 21689, 21690, | | 20180, 20186, | EMPREX | 21422, 21546 |
| | 10724, 10749, | | 21692, 21693, | | 20451, 20463, | ENVISION | 20030, 20813, |
| | 10775, 10819, | | 21935 | | 21669, 21671, | | 21365 |
| | 11076, 11142, | ALBATRON | 20170, 20179 | | 21672, 21935 | EPSON | 20833, 20840, |
| | 11442, 11749 | ALBA | 20037 | CLARION | 20180 | | 21122, 21290 |
| PIONEER | 11142, 11442 | ALFIDE | 20700, 20843 | CLASSIC | 20030, 20092 | ESA | 20171, 20812 |
| PRIMESTAR | 10869 | ALLERON | 20672 | COLORTYME | 20017, 20030, | FISHER | 20000, 20054, |
| PROSCAN | 10392, 10566 | AMBASSADOR | 20030, 20170 | | 20047, 20054, | | 20154 |
| PROTON | 11535 | | 20150 | COMMERCIAL SOLUTIONS | 20060, 20178 | FORTRESS | 20093 |
| RADIOSHACK | 10566, 10775, | AMERICA ACTION | 20180 | | 20047, 21447 | FUJITSU | 20179, 20186, |
| | 10869 | | 20000, 20060 | CONIC | 20178 | | 20683, 20809, |
| RCA | 10143, 10392, | AMERICAN HIGH | 20171 | CONTEC | 20180 | | 20853, 21181, |
| | 10566, 10775, | AMSTRAD | 20171 | CRAIG | 20161, 20171, | FUJITSU GENERAL | 21607 |
| | 10855, 11142, | AMTRON | 20000, 20180 | | 20179, 20180 | | 20186 |
| | 11392, 11442 | ANAM | 20180 | CROSLEY | 20000, 20030, | FUNAI | 20000, 20171, |
| SAMSUNG | 11108, 11109, | ANAM NATIONAL | 20161 | | 20054, 20171, | | 20179, 20180, |
| | 11142, 11276, | | 20030, 20180, | CROWN | 20180 | | 20264, 20342, |
| | 11377, 11442, | AOC | 21365, 21590 | | 20093, 20180, | | 21271 |
| | 11609 | APEX DIGITAL | 20156, 20748, | CROWN MUSTANG | 20672 | FUTURETECH | 20180 |
| SANYO | 11182, 11219 | | 20765, 20767, | | 20672 | GATEWAY | 21001, 21002, |
| SHARP | 10494, 11489, | ASTAR | 20879, 20890, | CURTIS MATHES | 20000, 20030, | | 21003, 21004, |
| | 11513, 11517 | | 21217 | | 20037, 20047, | GE | 21755, 21756 |
| SKY | 10099, 10856 | AUDINAC | 21531, 21548, | | 20051, 20054, | | 20000, 20030, |
| SONY | 10163, 10275, | AUDIOVOX | 21738 | | 20060, 20093, | | 20047, 20051, |
| | 10294, 10639, | | 20180, 20451, | | 20145, 20154, | | 20060, 20178, |
| | 11524, 11639, | | 20623, 20802, | | 20166, 20178, | | 20451, 21147, |
| | 11640 | | 20875, 21284 | | 20179, 20180, | | 21347, 21447 |
| STAR CHOICE | 10869 | AVENTURA | 20171 | CXC | 20451, 20702, | GEMINI | 20047 |
| STAR TRAK | 10772, 10869 | BAYCREST | 20186 | CYTRON | 21147, 21347 | GENERAL | 20030 |
| THOMSON | 10392, 10566 | BAYSONIC | 20180 | DAEWOO | 20180 | GIBRALTER | 20000, 20017, |
| TIVO | 11142, 11442, | BEAUMARK | 20017, 20030, | | 20180 | | 20030 |
| | 11443, 11444 | | 20178, 20179 | | 20036, 20092, | GO VIDEO | 20886 |
| TOSHIBA | 10486, 10749, | BELCOR | 20030 | | 20178, 20264, | GOLDSTAR | 20030, 20036, |
| | 10790, 11285, | BELL & HOWELL | 20054, 20093, | | 20451, 20623, | | 20037, 20047, |
| | 11501, 11516, | | 21257, 21258 | | 20661, 20672, | | 20054, 20178, |
| | 11530, 11749 | | 20154, 20179 | DAYTON | 21661, 21755, | GOODMANS | 21154, 21378 |
| UEC | 11356 | BENQ | 21032, 21212, | | 21756 | GPX | 20037 |
| ULTIMATETV | 11392, 11640 | | 21315 | DAYTRON | 20092 | GRADIENTE | 20053, 20170 |
| ULTRASAT | 11806 | BOXLIGHT | 20893 | | 20030, 20036, | GRAN PRIX | 20179 |
| UNIDEN | 10722, 10724, | BRADFORD | 20180 | DELL | 20092, 20178 | GRANADA | 20037 |
| | 11521 | BRILLIAN | 21007, 21255, | | 21080, 21178, | GRUNDIG | 20037, 20672, |
| | 11535 | | 21257, 21258 | | 21264, 21403 | | 20683, 20706 |
| US DIGITAL | 11535 | BROCKWOOD | 20030, 20178 | DELTA | 21369 | GRUNDY | 20179, 20180 |
| USDTV | 11535 | BROKSONIC | 20180, 20236, | DENON | 20145, 20511 | GRUNPY | 20179, 20180 |
| VOOM | 10869 | | 20463, 21935 | DREAM VISION | | H & B | 21366 |
| ZENITH | 10856, 11810, | BROTHER | 20264 | | 21164, 21297 | HAIER | 21034, 21748 |
| | 11856 | BYD:SIGN | 21309, 21311, | DUMONT | 20017, 20178, | HALLMARK | 20178, 20179, |
| | | | 21485, 21486 | | 20180 | | 20180, 20236 |
| TV | | CADIA | 21283 | DURABRAND | 20171, 20178, | HANNSPREE | 21348, 21351, |
| 3M | 21616 | CANDLE | 20030, 20186 | | 20180, 20463, | | 21352, 21745 |
| A-MARK | 20047, 20054, | | | | 21034 | HARLEY DAVIDSON | |
| | 20160 | | | DWIN | 20093 | | 20000, 20030, |
| ACCURIAN | 21803 | | | DYNEX | 21463 | | 20060, 20178, |
| ACCUSCAN | 20047 | | | EATON | 20060 | | 20179, 20180 |
| ACTION | 20030 | | | | | HARMAN/KARDON | 20054 |

| | | | | | | | |
|-----------------|---------------|----------------|---------------|---------------|---------------|------------|---------------|
| HARVARD | 20180 | LLOYD'S | 20030, 20179, | MOTOROLA | 20051, 20054, | PETTERS | 21523 |
| HAVERMY | 20093 | | 20180, 20236 | | 20093, 20150, | PHILCO | 20030, 20054, |
| HEATHKIT | 20017 | LOGIK | 20179, 20180, | | 20835 | | 20145, 20179, |
| HELIOS | 20865 | | 20236 | MOXELL | 20835 | | 20186, 20463 |
| HELLO KITTY | 20451 | LUMATRON | 20037, 20264 | MTC | 20030, 20060, | PHILIPS | 20030, 20037, |
| HEWLETT PACKARD | | LXI | 20000, 20017, | | 20092, 20180 | | 20054, 20171, |
| | 21088, 21089, | | 20030, 20036, | MULTITECH | 20179, 20180 | | 20186, 20690, |
| | 21101, 21494, | | 20037, 20047, | NAD | 20037, 20156, | | 21154, 21254, |
| | 21502, 21642 | | 20051, 20053, | | 20166, 20178, | | 21454, 21455, |
| HISENSE | 20748, 21660 | | 20054, 20060, | | 20866, 21156 | | 21483, 21744 |
| HITACHI | 20000, 20017, | | 20093, 20154, | NAKAMICHI | 21493 | PILOT | 20030, 20051, |
| | 20036, 20047, | | 20156, 20166, | NEC | 20030, 20036, | | 20060, 20178 |
| | 20051, 20054, | | 20171, 20178, | | 20047, 20156, | PIONEER | 20166, 20679, |
| | 20145, 20178, | | 20179 | | 20170, 20178, | | 20866, 21260, |
| | 20179, 21145, | MACY | 20186 | | 20474, 20704, | | 21398, 21457 |
| | 21150, 21245, | MAG | 21498 | | 20882, 21398, | PLANAR | 21496 |
| | 21345, 21378, | MAGNASONIC | | | 21456, 21704, | POLAROID | 20765, 20865, |
| | 21445 | | 20000, 20030, | | 21797 | | 21262, 21276, |
| HP | 21088, 21089, | | 20054, 20092, | NETTV | 21755 | | 21314, 21316, |
| | 21101, 21494, | | 20093, 20156, | NIKKO | 20030, 20092, | | 21326, 21327, |
| | 21502, 21642 | | 20179 | | 20178 | | 21328, 21341, |
| HUMAX | 21501 | MAGNAVOX | 20000, 20030, | NIKKODO | 20030, 20092, | | 21498, 21523, |
| HYUNDAI | 20849, 20865, | | 20036, 20037, | | 20178 | | 21538, 21763, |
| | 21219, 21294 | | 20047, 20051, | NIKO | 21581, 21618 | | 21766, 21767, |
| ICE | 20264 | | 20054, 20060, | NISHI | 20030 | | 21769, 22002 |
| ILO | 21286, 21603, | | 20092, 20154, | NORCENT | 20748, 20824, | PORTLAND | 20092, 20451 |
| | 21684 | | 20171, 20179, | | 21089, 21365, | PRECISION | 20180, 20236 |
| IMA | 20178, 20179, | | 20180, 20186, | | 21589, 21590, | PRIMA | 20761, 20783, |
| | 20180, 20236 | | 20250, 20706, | | 21591 | | 20815, 20817 |
| INFINITY | 20054 | | 20802, 21198, | NORWOOD MICRO | | PRINCETON | 20700 |
| INFOCUS | 21164, 21430, | | 21254, 21365, | | 21286, 21296, | PRISM | 20051, 20250 |
| | 21516 | | 21454, 21525, | | 21303 | PROSCAN | 20047, 21347, |
| INITIAL | 21603 | | 21755 | NTC | 20092 | | 21447 |
| INNOVA | 20037 | MAJESTIC | 20017 | NYON | 20000 | PROTEC | 20037, 20264 |
| INSIGNIA | 20171, 21204, | MARANTZ | 20030, 20037, | OLEVIA | 21144, 21240, | PROTON | 20178 |
| | 21326, 21517, | | 20054, 20704, | | 21331, 21610 | PROTRON | 21320, 21323 |
| | 21564, 21641, | | 20854, 20855, | ONWA | 20180 | PROVIEW | 20835, 21401, |
| | 22002, 21710 | | 21154, 21398, | OPTIMUS | 20030, 20093, | | 21498 |
| INTEQ | 20017, 20145 | | 21454 | | 20150, 20154, | PROVISION | 20037 |
| JBL | 20054 | MARK | 20037 | | 20166, 20178, | PULSAR | 20017, 20092 |
| JCB | 20000 | MATSUI | 20036, 20037 | | 20180, 20250, | PULSER | 20092, 20178 |
| JENSEN | 20761, 20815, | MATSUSHITA | 20051, 20161, | | 20650 | PUNEET | 21546 |
| | 20817, 21299 | | 20250, 20650 | OPTOMA | 20887, 21348, | QUARTZ | 20150, 20178 |
| JIL | 20030 | MAXENT | 21211, 21714, | | 21622, 21673, | QUASAR | 20051, 20250, |
| JINXING | 20037 | | 21755, 21756, | | 21674 | | 20650 |
| JUTAN | 20030 | | 21757 | OPTONICA | 20093 | R-LINE | 20037 |
| JVC | 20030, 20036, | MEGAPOWER | 20700 | ORION | 20017, 20178, | RABBIT | 20047 |
| | 20053, 20054, | MEGATRON | 20047, 20145, | | 20179, 20180, | RADIOSHACK | 20030, 20047, |
| | 20160, 20650, | | 20178 | | 20236, 20463, | | 20150, 20154, |
| | 20653, 20731, | MEMOREX | 20030, 20037, | | 21463 | | 20178, 20180 |
| | 21172, 21253, | | 20150, 20154, | PACE | 20092 | RCA | 20000, 20047, |
| | 21302, 21352, | | 20178, 20179, | PACIFIC | 20037 | | 20051, 20054, |
| | 21428, 21774 | | 20180, 20463 | PALSONIC | 20264 | | 20090, 20093, |
| KAMP | 20017, 20180 | MERMAID | 20037 | PANASONIC | 20000, 20030, | | 20178, 20679, |
| KAWASHO | 20030 | MGA | 20030, 20150, | | 20051, 20054, | | 21047, 21147, |
| KDS | 21498 | | 20178 | | 20156, 20161, | | 21247, 21347, |
| KEC | 20060, 20180 | MGN TECHNOLOGY | | | 20236, 20250, | | 21447, 21547, |
| KENWOOD | 20030, 20180 | | 20178 | | 20650, 20863, | | 21781, 22002 |
| KLH | 20156, 20180, | MICRO | 21436 | | 21168, 21175, | REALISTIC | 20030, 20047, |
| | 20765, 20767 | MICRO GENIUS | | | 21177, 21291, | | 20150, 20154, |
| KLOSS | 20030 | | 20150 | | 21310, 21335, | | 20178, 20180 |
| KONKA | 20180 | MIDLAND | 20017, 20047, | | 21410, 21480, | REVOX | 20037 |
| KOST | 21262, 21483 | | 20051 | | 21510 | RUNCO | 20017, 20030, |
| KTV | 20030, 20180, | MINATO | 20037 | PANDA | 20706 | | 20060, 21292, |
| | 20463 | MINTEK | 21603 | PAUSA | 20179 | | 21397, 21398, |
| LARK | 20154 | MITSUBISHI | 20030, 20036, | PAXONIC | 20030, 20060 | | 21628, 21629, |
| LG | 20030, 20054, | | 20093, 20150, | PCE | 20060, 20156, | | 21638, 21639, |
| | 20060, 20178, | | 20154, 20160, | | 20179 | | 21679 |
| | 20442, 20700, | | 20178, 20250, | PENNEY | 20000, 20030, | SAMPO | 20030, 20047, |
| | 20856, 21154, | | 20836, 20868, | | 20036, 20037, | | 21755, 21756 |
| | 21178, 21265, | | 21150, 21171, | | 20047, 20051, | | |
| | 21325, 21378, | | 21182, 21250, | | 20060, 20156, | | |
| | 21423, 21663, | | 21392, 21522, | | 20161, 20178, | | |
| | 21758 | | 21550 | | 20250, 21347, | | |
| | | MONIVISION | 20700, 20843 | | 21378 | | |

| | | | | | | | |
|-----------------|---|-------------------|---|--------------------|--|------------------------|---|
| SAMSUNG | 20017, 20030, 20036, 20037, 20047, 20054, 20060, 20154, 20178, 20264, 20587, 20702, 20766, 20812, 20814, 21060, 21312, 21395, 21458 | SPECTRONIQ | 21498 | TOTEVISION | 20051 | PVR | |
| | | SQUAREVIEW | 20171 | TOYOMENKA | 20178 | ABS | 31972 |
| | | SR | 2000, 20154, 20171 | TRUETONE | 20051, 20250 | ALIENWARE | 31972 |
| | | SSS | 20180 | TRUTECH | 21723 | CYBERPOWER | 31972 |
| | | STARLITE | 20180, 20236 | TVS | 20463 | DELL | 31972 |
| | | STUDIO EXPERIENCE | 20843 | ULTRA | 20092, 21323 | DIRECTV | 30739 |
| | | SUPERSCAN | 20093, 20864 | UNIVERSAL | 20047 | GATEWAY | 31972 |
| | | SUPRE-MACY | 20186 | UNIVERSUM | 20036, 20037, 20170, 20264, 20474 | GO VIDEO | 30614 |
| SANKY | 20030, 20060 | SUPREME | 20000 | US LOGIC | 21286, 21303 | HEWLETT PACKARD | 31972 |
| SANSUI | 20030, 20060, 20463, 21935 | SV2000 | 20054 | V | 20864, 20885, 21755, 21756 | HITACHI | 30140, 31718 |
| SANYO | 20000, 20036, 20037, 20047, 20054, 20088, 20154, 20171, 20376, 20424, 20463, 20799, 20893, 21142, 21179, 21755 | SVA | 20587, 20748, 20865, 20870, 20871 | VECTOR RESEARCH | 20030 | HOWARD COMPUTERS | |
| | | SYLVANIA | 20000, 20030, 20036, 20037, 20047, 20051, 20054, 20092, 20154, 20171, 20178, 20179, 20186, 21271, 21314, 21394 | VEOS | 21007 | HP | 31972 |
| SAVILLE | 20060 | SYMPHONIC | 20000, 20171, 20178, 20179, 20180 | VICTOR | 20036, 20053, 20160, 20653, 21428 | HUGHES NETWORK SYSTEMS | 30739 |
| SCEPTRE | 20878, 21217, 21360, 21599 | SYNTAX | 21144, 21240, 21331, 21610 | VIDIKRON | 20054, 21292, 21302, 21397, 21398, 21628, 21629 | HUMAX | 30739, 31797, 31988 |
| SCOTCH | 20178 | TANDY | 20093 | VIDTECH | 20036, 20178 | HUSH | 31972 |
| SCOTT | 20030, 20178, 20179, 20180, 20236, 21711 | TATUNG | 20000, 20037, 20051, 21101, 21285, 21286, 21287, 21288, 21361, 21756 | VIEWSONIC | 20857, 20864, 20885, 21330, 21542, 21578, 21627, 21640, 21742, 21755 | IBUYPOWER | 31972 |
| SEARS | 20000, 20017, 20030, 20036, 20037, 20047, 20051, 20053, 20054, 20060, 20093, 20154, 20156, 20166, 20171, 20178, 20179, 21007 | TEAC | 20037, 20154, 20264, 20706 | VIZIO | 20864, 20885, 21499, 21755, 21756, 21758 | JVC | 31279 |
| | | TECHNICS | 20051, 20054, 20250 | VIKING | 20060 | LINKSYS | 31972 |
| SELECO | 21297, 21351 | TECHNOL ACE | 20179 | VIORE | 21207, 21684 | MEDIA CENTER PC | 31972 |
| SHARP | 20036, 20054, 20093, 20179, 20180, 20256, 20787, 20818, 20851, 21165, 21453, 21459, 21602 | TECHNOVOX | 20030 | VISART | 21336 | MICROSOFT | 31972 |
| | | TECHWOOD | 20051, 20060, 20250 | VIZIO | 20864, 20885, 21499, 21755, 21756, 21758 | MIND | 31972 |
| | | TECO | 21040 | WARDS | 20000, 20017, 20030, 20037, 20047, 20051, 20054, 20093, 20154, 20166, 20178, 20179, 20186, 20236, 20866, 21156 | MITSUBISHI | 31714 |
| | | TEKNIKA | 20054, 20060, 20092, 20150, 20178, 20179, 20180, 20186, 20463 | WAYCON | 20156 | NIVEUS MEDIA | 31972 |
| SHENG CHIA | 20093 | TELECOLOR | 20017 | WELTON | 20178 | NORTHGATE | 31972 |
| SHERWOOD | 21399 | TELEFUNKEN | 20702 | WESTINGHOUSE | 20000, 20451, 20885, 20889, 20890, 21092, 21282, 21577, 21712 | PANASONIC | 30614, 30616, 31244, 31732, 31807, 31808, 31809 |
| SHIVAKI | 20037, 20178 | TELETON | 20186 | WHITE WESTINGHOUSE | 20179, 20236, 20451, 20463, 20623, 20889 | PHILIPS | 30618, 30739 |
| SIEMENS | 20145 | TEVION | 20037 | WINBOOK | 21381 | PIONEER | 31337, 31803 |
| SIGNATURE | 20030, 20047, 20093, 20179 | THOMAS | 20047, 20178 | WORLD | 20180, 20236, 20451, 20463 | RCA | 30880 |
| SIGNET | 21262 | THOMSON | 20047, 21447 | WYSE | 21365 | REPLAYTV | 30614, 30616 |
| SIM2 MULTIMEDIA | 21297 | TMK | 20178, 20180, 20236 | XR-1000 | 20154, 20171, 20179, 20180 | SAMSUNG | 30739 |
| SIMPSON | 20030, 20178, 20186 | TNCI | 20017 | YAMAHA | 20030, 20769, 20833, 20839, 21405, 21406, 21407, 21526, 21522 | SHARP | 31742, 31810, 31893 |
| SINGER | 20060, 20092 | TOCOM | 20156 | ZENITH | 20000, 20017, 20030, 20037, 20047, 20092, 20093, 20145, 20160, 20171, 20178, 20463, 20812, 21145, 21265 | SONIC BLUE | 30614, 30616 |
| SKY-NORTH | 20037 | TOSHIBA | 20036, 20060, 20145, 20150, 20154, 20156, 20166, 20264, 20509, 20650, 20832, 20845, 21145, 21156, 21164, 21169, 21173, 21256, 21265, 21306, 21325, 21343, 21356, 21369, 21429, 21456, 21524, 21635, 21656, 21704, 21935 | | | SONY | 30636, 31447, 31448, 31636, 31972 |
| SOLAR DRAPE | 20000 | | | | | STACK 9 | 31972 |
| SOLE | 20813 | | | | | SYSTEMAX | 31972 |
| SONY | 20000, 20017, 20036, 20053, 20150, 20154, 20810, 20834, 20867, 21100, 21167, 21300, 21317, 21651, 21685 | | | | | TAGAR SYSTEMS | 31972 |
| SOUNDESIGN | 20178, 20179, 20180, 20186 | | | | | TIVO | 30618, 30636, 30739, 31337 |
| SOVA | 21320 | | | | | TOSHIBA | 30828, 31008, 31739, 31972, 31988, 31996 |
| SOYO | 21520, 21546 | | | | | TOUCH | 31972 |
| SPECTRAVISION | 20156, 20178, 20179, 20186 | | | | | VICTOR | 31706 |
| | | | | | | VIEWSONIC | 31972 |
| | | | | | | VOODOO | 31972 |
| | | | | | | ZT GROUP | 31972 |

| | | | | | | | |
|----------------|---|-------------|--|------------------------|---|-----------------|--|
| ADYSON | 30072 | CYBERPOWER | 31972 | GOODMANS | 30000, 30020, 30037, 30062, 30072, 30081, 30278, 30637 | M ELECTRONIC | 30240 |
| AIKO | 30278 | DAEWOO | 30020, 30037, 30045, 30046, 30278, 30561, 30637, 31137, 31278 | GRADIENTE | 30000, 30008, 30408 | MAGNASONIC | 30000, 30020, 30037, 30072, 30082, 30240, 30278, 30593, 31278 |
| AIWA | 30000, 30037, 30124, 30307, 30348, 30479, 31137, 31284, 31291, 31332, 31336 | DAYTRON | 30020, 30037, 30278 | GRANADA | 30042, 30081 | MAGNAVOX | 30000, 30035, 30037, 30039, 30048, 30054, 30081, 30110, 30149, 30226, 30240, 30563, 30593, 30618, 31593, 31781 |
| AKAI | 30041, 30049, 30061, 30106, 30175, 30242 | DBX | 30040 | GRUNDIG | 30034, 30081, 30226 | MAGNIN | 30240 |
| ALBA | 30072, 30209, 30278, 30295 | DELL | 31972 | HARLEY DAVIDSON | 30000 | MARANTZ | 30035, 30038, 30062, 30081, 31381 |
| ALIENWARE | 31972 | DENON | 30042, 30081 | HARMAN/KARDON | 30038, 30075, 30081 | MARTA | 30037 |
| ALLEGRO | 30039, 31137 | DERWENT | 30041 | HARVARD | 30068, 30072 | MATSUI | 30036, 30037, 30209, 30295, 30348 |
| AMERICA ACTION | 30278 | DIRECTV | 30739 | HARWOOD | 30068, 30072 | MATSUSHITA | 30035, 30081, 30162, 30226, 31162 |
| AMERICAN HIGH | 30035, 30081 | DUAL | 30000 | HEADQUARTER | 30046 | MEDIA CENTER PC | 31972 |
| AMSTRAD | 30000 | DUMONT | 30040 | HEWLETT PACKARD | 31972 | MEDION | 30348 |
| ANAM NATIONAL | 30226 | DURABRAND | 30038, 30039 | HI-Q | 30000, 30035, 30047 | MEI | 30035 |
| ASHA | 30240 | DYNATECH | 30000, 30240 | HITACHI | 30000, 30035, 30037, 30041, 30042, 30045, 30065, 30082, 30089, 30105, 30140, 30166, 30544, 31037, 31286, 31326, 31718 | MEMOREX | 30000, 30035, 30037, 30039, 30046, 30047, 30048, 30054, 30062, 30072, 30104, 30162, 30209, 30240, 30278, 30307, 30348, 30479, 31037, 31162, 31237, 31262 |
| ASTRA | 30035, 30240 | ELECTROHOME | 30000, 30037, 30043, 30060, 30061, 30209, 30240 | HOWARD COMPUTERS | 31972 | METZ | 30037 |
| AUDIO DYNAMICS | 30040 | EMERALD | 30121, 30184 | HP | 31972 | MGA | 30043, 30060, 30061, 30240 |
| AUDIOVOX | 30037, 30038, 30054, 30278 | EMEREX | 30032 | HUGHES NETWORK SYSTEMS | 30042, 30739 | MGN TECHNOLOGY | 30240 |
| AVIS | 30000, 30072 | EMERSON | 30000, 30002, 30036, 30037, 30043, 30061, 30068, 30121, 30184, 30202, 30208, 30209, 30278, 30295, 30348, 30479, 31479, 31593 | HUMAX | 30739, 31797, 31988 | MICROSOFT | 31972 |
| BEAUMARK | 30240 | ESA | 31137 | HUSH | 31972 | MIDLAND | 30240 |
| BELL & HOWELL | 30000, 30035, 30039, 30046, 30048, 30104, 30479 | FISHER | 30000, 30039, 30046, 30047, 30054, 30066, 30104 | HYTEK | 30000, 30036, 30047, 30072 | MIND | 31972 |
| BROKSONIC | 30002, 30121, 30184, 30208, 30209, 30295, 30348, 30479, 31479 | FUJI | 30033, 30035 | IBUYPOWER | 31972 | MINOLTA | 30042, 30105 |
| CALIX | 30037 | FUJITSU | 30000, 30045 | INSTANT REPLAY | 30035, 30226 | MITSUBISHI | 30000, 30041, 30042, 30043, 30047, 30048, 30060, 30061, 30067, 30075, 30173, 30214, 30242, 30443, 30807, 31343, 31631, 31714 |
| CANDLE | 30037, 30038 | FUNAI | 30000, 30037, 30072, 30278, 30593, 31333, 31593 | ITT NOKIA | 30041, 30240 | MOTOROLA | 30035, 30048 |
| CANON | 30034, 30035 | GARRARD | 30000 | JANEIL | 30240 | MOVIE WALKER | 30072 |
| CAPEHART | 30002, 30020, 30062 | GATEWAY | 31972 | JENSEN | 30041, 30067 | MTC | 30000, 30072, 30240 |
| CARRERA | 30240 | GE | 30000, 30035, 30048, 30060, 30065, 30077, 30149, 30202, 30240, 30760, 30761, 30807, 31035, 31060 | JVC | 30008, 30041, 30061, 30067, 30206, 31162, 31279, 31283, 31299, 31329 | MTX | 30000 |
| CARVER | 30035, 30081 | GENEXXA | 30000, 30037, 30278 | KEC | 30037, 30278 | MULTITECH | 30000, 30039, 30072 |
| CCE | 30072, 30278 | GO VIDEO | 30240, 30279, 30432, 30526, 30614, 30643, 31137 | KENWOOD | 30038, 30041, 30046, 30067 | NAD | 30104, 30240 |
| CINERAL | 30278 | GOLDSTAR | 30000, 30035, 30037, 30038, 30039, 30054, 30278, 31137, 31237 | KLH | 30072 | NEC | 30038, 30040, 30082, 30104, 31287, 31288 |
| CINEVISION | 31137 | | | KODAK | 30035, 30037 | NEW TECH | 30072 |
| CITIZEN | 30000, 30035, 30036, 30037, 30209, 30240, 30278, 30479, 31278 | | | KTV | 30000 | NIKKO | 30037, 30278 |
| CLASSIC | 30037 | | | LG | 30037, 30038, 30240, 31037, 31137 | | |
| COLORTYME | 30035, 30045, 30060, 30278 | | | LIFETEC | 30348 | | |
| COLT | 30000, 30072 | | | LINKSYS | 31972 | | |
| CRAIG | 30037, 30047, 30072, 30240, 30271 | | | LLOYD'S | 30000, 30036, 30038, 30040, 30072, 30208, 30240 | | |
| CRITERION | 30000, 30072 | | | LOEWE | 30081 | | |
| CROSLEY | 30000, 30035, 30081, 30110, 30149 | | | LOGIK | 30000, 30072, 30240 | | |
| CROWN | 30072, 30278 | | | LUMATRON | 30278 | | |
| CURTIS MATHES | 30000, 30035, 30041, 30060, 30162, 30240, 30278, 30432, 30643, 30760, 31035 | | | LUXOR | 30046, 30106 | | |
| CYBERNEX | 30240 | | | LXI | 30000, 30037, 30042, 30054, 30067 | | |

| | | | | | | | |
|--------------|---------------|--------------------|---------------|---------------|---------------|--------------------|---------------|
| NIKKODO | 30037, 30278 | PULSAR | 30039, 30240, | SEARS | 30000, 30033, | THOMAS | 30000, 30002 |
| NIKON | 30034 | | 30278 | | 30034, 30035, | THOMSON | 30041, 30060, |
| NISHI | 30240 | PULSER | 30240 | | 30036, 30037, | | 30202 |
| NIVEUS MEDIA | | QUARTER | 30046 | | 30039, 30041, | TISONIC | 30278 |
| | 31972 | QUARTZ | 30035, 30046, | | 30042, 30043, | TIVO | 30618, 30636, |
| NOBLEX | 30240 | | 30047 | | 30045, 30046, | | 30739, 31337, |
| NORTHGATE | 31972 | QUASAR | 30002, 30035, | | 30047, 30048, | | 31996 |
| OLYMPUS | 30035, 30104, | | 30077, 30162, | | 30054, 30060, | TMK | 30000, 30036, |
| | 30162, 30226 | | 30226, 31035, | | 30065, 30066, | | 30208, 30240 |
| ONKYO | 30222 | | 31162 | | 30067, 30072, | TNIX | 30037 |
| OPTIMUS | 30000, 30035, | RADIOHACK | 30000, 30035, | | 30104, 30105, | TOCOM | 30240 |
| | 30037, 30047, | | 30037, 30046, | | 30162, 30209, | TOSHIBA | 30000, 30041, |
| | 30048, 30054, | | 30047, 30048, | | 31237 | | 30042, 30043, |
| | 30062, 30104, | | 30062, 30066, | SHARP | 30000, 30032, | | 30045, 30054, |
| | 30162, 30240, | | 30104, 30162, | | 30047, 30048, | | 30062, 30066, |
| | 30432, 30593, | | 30240, 31037, | | 30062, 30065, | | 30209, 30210, |
| | 31048, 31062, | | 31162 | | 30807, 30848, | | 30212, 30240, |
| | 31162, 31262 | RADIX | 30037 | | 31285, 31742, | | 30544, 30828, |
| OPTONICA | 30062 | RANDEX | 30037 | | 31810, 31893 | | 30845, 31008, |
| ORION | 30000, 30002, | RCA | 30000, 30035, | SHINTOM | 30000, 30039, | | 31145, 31289, |
| | 30036, 30104, | | 30042, 30045, | | 30072, 30208, | | 31290, 31323, |
| | 30121, 30184, | | 30048, 30054, | | 30240 | | 31325, 31739, |
| | 30208, 30209, | | 30060, 30065, | SHOGUN | 30240 | | 31972, 31988, |
| | 30240, 30278, | | 30077, 30105, | SIEMENS | 30037, 30104 | | 31996 |
| | 30295, 30479, | | 30106, 30149, | SIGNATURE | 30000, 30035, | TOSONIC | 30278 |
| | 31479 | | 30166, 30202, | | 30037, 30046, | TOTEVISION | 30037, 30240 |
| PANAMA | 30035 | | 30240, 30760, | | 30048, 30060, | TOUCH | 31972 |
| PANASONIC | 30000, 30020, | | 30761, 30807, | | 30065, 30066, | TRIX | 30037 |
| | 30035, 30077, | | 30880, 31035, | | 30149, 30479 | ULTRA | 30020, 30045, |
| | 30162, 30225, | | 31060 | SINGER | 30037, 30072, | | 30278 |
| | 30226, 30378, | REALISTIC | 30000, 30035, | | 30240 | UNITECH | 30240 |
| | 30614, 30616, | | 30037, 30046, | SONIC BLUE | 30614, 30616, | VECTOR | 30045 |
| | 31035, 31062, | | 30047, 30048, | | 30643, 31137 | VECTOR RESEARCH | |
| | 31162, 31244, | | 30062, 30065, | SONOGRAPHE | 30046 | | 30038, 30040, |
| | 31262, 31292, | | 30066, 30104, | SONY | 30000, 30032, | | 30184 |
| | 31293, 31308, | | 30121, 30162, | | 30033, 30034, | VEXTRA | 30072 |
| | 31317, 31732, | | 30240, 30278, | | 30035, 30046, | VICTOR | 30008, 30041, |
| | 31807, 31808, | | 31162 | | 30047, 30049, | | 30067, 31283, |
| | 31809 | REPLAYTV | 30614, 30616 | | 30067, 30226, | | 31299, 31706 |
| PENNEY | 30000, 30035, | RICAIVISION | 31972 | | 30636, 31032, | VIDEO CONCEPTS | |
| | 30037, 30038, | RICOH | 30034 | | 31232, 31295, | | 30040, 30045, |
| | 30040, 30042, | RIO | 31137 | | 31296, 31297, | | 30061, 30210, |
| | 30047, 30054, | RUNCO | 30039 | | 31447, 31448, | | 30242 |
| | 30067, 30077, | SALORA | 30075 | | 31636, 31702, | VIDEOMAGIC | 30037 |
| | 30081, 30162, | SAMSUNG | 30000, 30038, | | 31972 | VIDEOSONIC | 30000, 30072, |
| | 30240, 31035, | | 30045, 30060, | SOUNDMASTER | | | 30240 |
| | 31237 | | 30077, 30240, | | 30000 | VIEWSONIC | 31972 |
| PENTAX | 30042, 30065, | | 30432, 30739, | STACK 9 | 31972 | VILLAIN | 30000 |
| | 30105 | | 31014 | STS | 30042, 30105 | VOODOO | 31972 |
| PHILCO | 30000, 30035, | SAMTRON | 30240, 30643 | SV2000 | 30000, 30072 | WARDS | 30000, 30033, |
| | 30081, 30110, | SANKY | 30039, 30048 | SVA | 30000 | | 30035, 30037, |
| | 30209, 30479 | SANSUI | 30000, 30002, | SYLVANIA | 30000, 30035, | | 30038, 30041, |
| PHILIPS | 30000, 30034, | | 30041, 30067, | | 30043, 30081, | | 30042, 30043, |
| | 30035, 30045, | | 30072, 30082, | | 30110, 30593, | | 30045, 30046, |
| | 30048, 30062, | | 30209, 30240, | | 31593, 31781 | | 30047, 30048, |
| | 30081, 30110, | | 30271, 30479, | SYMPHONIC | 30000, 30002, | | 30060, 30062, |
| | 30162, 30209, | | 31479 | | 30240, 30593, | | 30065, 30072, |
| | 30616, 30618, | SANYO | 30000, 30046, | | 31593 | | 30081, 30149, |
| | 30739, 31081, | | 30047, 30104, | SYSTEMAX | 31972 | | 30212, 30240, |
| | 31181, 31266, | | 30159, 30240, | TAGAR SYSTEMS | | | 30479, 30760 |
| | 31381 | | 30479, 31330, | | 31972 | WHARFEDALE | |
| PILOT | 30037 | | 31331 | TANDY | 30000, 30104 | | 30593 |
| PIONEER | 30042, 30067, | SCIENTIFIC ATLANTA | | TASHIKO | 30037 | WHITE WESTINGHOUSE | |
| | 30081, 30162, | | 30008 | TATUNG | 30000, 30008, | | 30000, 30072, |
| | 31337, 31803 | SCOTT | 30036, 30043, | | 30041, 30048, | | 30209, 30278, |
| POLK AUDIO | 30081 | | 30045, 30121, | | 30067, 30081 | | 30479, 30637 |
| PORTLAND | 30020, 30278 | | 30184, 30208, | TEAC | 30000, 30041, | WORLD | 30002, 30209, |
| PRESIDIAN | 31593 | | 30210, 30212 | | 30067 | | 30479 |
| PROFITRONIC | 30240 | | | TECHNICS | 30000, 30035, | XR-1000 | 30000, 30035, |
| PROSCAN | 30060, 30202, | | | | 30037, 30162 | | 30072, 30208, |
| | 30760, 30761, | | | TEKNIKA | 30000, 30035, | | 30240 |
| | 31060 | | | | 30037 | YAMAHA | 30038, 30041 |
| PROTEC | 30000, 30072 | | | TELECORDER | 30240 | | |
| PROTECH | 30072 | | | TELEFUNKEN | 30041, 30208 | | |
| | | | | TEVION | 30479 | | |

| | | | | | | | |
|---------------------------|---|---|---|--|---|---|--|
| ZENITH | 30000, 30033, 30034, 30037, 30039, 30041, 30209, 30278, 30479, 30637, 31137, 31139, 31479 | CAMBRIDGE SOUNDWORKS | GE | 40522, 40717, 40815 | LASONIC | 40627, 40798, 41173, 41747 | |
| ZT GROUP | 31972 | 40690 | GENICA | 40750 | LECSON | 41533 | |
| DVD PLAYER | | | | | | | |
| 3D LAB | 40503, 40539 | CARY AUDIO DESIGN | GO VIDEO | 40573, 40715, 40717, 40741, 40744, 40783, 40833, 40869, 41044, 41075, 41099, 41144, 41148, 41158, 41304, 41443, 41483, 41730 | LENOXX | 41127 | |
| ACCURIAN | 40675, 41072, 41416, 41737 | CAVS | 41057, 41387 | 40717, 40741, 40744, 40783, 40833, 40869, 41044, 41075, 41099, 41144, 41148, 41158, 41304, 41443, 41483, 41730 | LEXICON | 40671 | |
| ACOUSTIC SOLUTIONS | | | | | | | |
| ADCOM | 41094 | CELESTIAL | 41020 | 40744, 40783, 40833, 40869, 41044, 41075, 41099, 41144, 41148, 41158, 41304, 41443, 41483, 41730 | LG | 40591, 40741, 40801, 40869, 41526, 41600 | |
| ADVENT | 41016 | CENTREX | 40672, 41004 | 41044, 41075, 41099, 41144, 41148, 41158, 41304, 41443, 41483, 41730 | LITEON | 41058, 41158, 41416, 41440, 41656, 41738 | |
| AFREEY | 40698 | CENTRIOS | 41577 | 41044, 41075, 41099, 41144, 41148, 41158, 41304, 41443, 41483, 41730 | LOEWE | 40511, 40741 | |
| AIWA | 40641 | CINEA | 40831 | 41044, 41075, 41099, 41144, 41148, 41158, 41304, 41443, 41483, 41730 | LOGIX | 40783 | |
| AKAI | 40695, 40705, 40770, 40899, 41089 | CINEMATRIX | 41052 | 41044, 41075, 41099, 41144, 41148, 41158, 41304, 41443, 41483, 41730 | MAGNASONIC | 40651, 40675 | |
| ALBA | 40672, 40717 | CINEVISION | 40833, 40869, 40876, 41483 | 41044, 41075, 41099, 41144, 41148, 41158, 41304, 41443, 41483, 41730 | MAGNAVOX | 40503, 40539, 40646, 40675, 40821, 41268, 41354, 41472, 41506 | |
| ALCO | 40790 | CITIZEN | 40695, 41003, 41277, 41587, 42116 | GO VISION | 41071, 41072 | MALATA | 40782, 41159 |
| ALLEGRO | 40869 | 42116 | CLAIRTONE | GOLDSTAR | 40741, 40801, 40869 | MARANTZ | 40503, 40539, 40675, 41627 |
| AMPHION MEDIA WORKS | 40872, 41245 | 40571 | CLASSE | GOODMANS | 40790 | MCINTOSH | 41273, 41373, 41533 |
| AMW | 40872, 41245 | 41543 | COBY | GPX | 40699, 40769 | MEDION | 40651 |
| APEX DIGITAL | 40533, 40672, 40717, 40755, 40794, 40795, 40796, 40797, 40830, 40856, 41004, 41020, 41056, 41061, 41100, 41126 | 41077, 41086, 41107, 41165, 41177, 41321, 41351, 41628 | CRAIG | GRADIENTE | 40490, 40651 | MEMOREX | 40695, 40831, 41270 |
| ARCAM | 40732 | 41077, 41086, 41107, 41165, 41177, 41321, 41351, 41628 | CREATIVE | GREENHILL | 40717 | MERIDIAN | 41497 |
| ARRGO | 41023 | 41077, 41086, 41107, 41165, 41177, 41321, 41351, 41628 | 40503, 40539 | GRUNDIG | 40539, 40705 | MICROSOFT | 40522, 41708, 42083 |
| ASPIRE DIGITAL | 40594, 41168, 41391, 41407 | 41077, 41086, 41107, 41165, 41177, 41321, 41351, 41628 | CURTIS MATHES | HARMAN/KARDON | 40582, 40702 42080 | MINATO | 40752 |
| ASTAR | 41461, 41489, 41494, 41678, 41679 | 41077, 41086, 41107, 41165, 41177, 41321, 41351, 41628 | 41087 | HELIOS | 42080 | MINTEK | 40717, 40839, 41472 |
| AUDIOLOGIC | 40736 | 41077, 41086, 41107, 41165, 41177, 41321, 41351, 41628 | CYBERHOME | HELLO KITTY | 40831 | MITSUBISHI | 40521, 41403, 41521, 41629 |
| AUDIOVOX | 40717, 40790, 41041, 41071, 41072, 41121, 41122 | 41077, 41086, 41107, 41165, 41177, 41321, 41351, 41628 | 40816, 40874, 41023, 41024, 41117, 41129, 41502, 41537 | HITACHI | 40573, 40664, 41247, 41664, 41764, 41765, 41766 | MIXSONIC | 41130 |
| AWA | 40730 | 41077, 41086, 41107, 41165, 41177, 41321, 41351, 41628 | 41023, 41024, 41117, 41129, 41502, 41537 | HITEKER | 40672 | MOMITSU | 41082, 41626 |
| AXION | 41071, 41072 | 41077, 41086, 41107, 41165, 41177, 41321, 41351, 41628 | 41023, 41024, 41117, 41129, 41502, 41537 | HUMAX | 41500, 41588 | MUSTEK | 40730 |
| B & K | 40655, 40662 | 41077, 41086, 41107, 41165, 41177, 41321, 41351, 41628 | 41023, 41024, 41117, 41129, 41502, 41537 | I-O DATA | 41405 | MYRYAD | 40894 |
| BANG & OLUFSEN | 41696 | 41077, 41086, 41107, 41165, 41177, 41321, 41351, 41628 | 41023, 41024, 41117, 41129, 41502, 41537 | ILO | 41348, 41472 | NAD | 40692, 40741 |
| BBK | 41224 | 41077, 41086, 41107, 41165, 41177, 41321, 41351, 41628 | 41023, 41024, 41117, 41129, 41502, 41537 | INITIAL | 40717, 41472 | NAIKO | 40770 |
| BEL CANTO DESIGN | 41571 | 41077, 41086, 41107, 41165, 41177, 41321, 41351, 41628 | 41023, 41024, 41117, 41129, 41502, 41537 | INNOVATIVE TECHNOLOGY | 41542 | NAKAMICHI | 41222 |
| BLADELIUS | 41682 | 41077, 41086, 41107, 41165, 41177, 41321, 41351, 41628 | 41023, 41024, 41117, 41129, 41502, 41537 | INOI | 41747 | NAXA | 41473 |
| BLAUPUNKT | 40717 | 41077, 41086, 41107, 41165, 41177, 41321, 41351, 41628 | 41023, 41024, 41117, 41129, 41502, 41537 | INSIGNIA | 41013, 41268, 41712, 42095 | NEC | 40785, 40869, 41404 |
| BLUE PARADE | 40571 | 41077, 41086, 41107, 41165, 41177, 41321, 41351, 41628 | 41023, 41024, 41117, 41129, 41502, 41537 | INTEGRA | 40571, 40627, 41634 | NESA | 40717 |
| BLUE SKY | 40695, 40699 | 41077, 41086, 41107, 41165, 41177, 41321, 41351, 41628 | 41023, 41024, 41117, 41129, 41502, 41537 | INTERVIDEO | 41124 | NEUNEO | 40509, 41454 |
| BOSE | 41895 | 41077, 41086, 41107, 41165, 41177, 41321, 41351, 41628 | 41023, 41024, 41117, 41129, 41502, 41537 | IRT | 40783 | NEXT BASE | 40826 |
| BOSS AUDIO SYSTEMS | 41680 | 41077, 41086, 41107, 41165, 41177, 41321, 41351, 41628 | 41023, 41024, 41117, 41129, 41502, 41537 | JATON | 41078 | NEXXTTECH | 41402 |
| BRANDT | 40651 | 41077, 41086, 41107, 41165, 41177, 41321, 41351, 41628 | 41023, 41024, 41117, 41129, 41502, 41537 | JBL | 40702 | NINTAUS | 41051 |
| BROKSONIC | 40695, 40868, 41419 | 41077, 41086, 41107, 41165, 41177, 41321, 41351, 41628 | 41023, 41024, 41117, 41129, 41502, 41537 | JENSEN | 40174, 41016 | NORCENT | 40719, 40872, 41003, 41107, 41265, 41457, 41461 |
| BUSH | 40690 | 41077, 41086, 41107, 41165, 41177, 41321, 41351, 41628 | 41023, 41024, 41117, 41129, 41502, 41537 | JMB | 40695 | NOVA | 41517, 41518, 41519, 41520 |
| BYD:SIGN | 40872 | 41077, 41086, 41107, 41165, 41177, 41321, 41351, 41628 | 41023, 41024, 41117, 41129, 41502, 41537 | JSI | 41423 | ONKYO | 40503, 40627, 40792, 41417, 41418, 41612, 41627, 41769 |
| CALIFORNIA AUDIO LABS | 40490 | 41077, 41086, 41107, 41165, 41177, 41321, 41351, 41628 | 41023, 41024, 41117, 41129, 41502, 41537 | JVC | 40558, 40623, 40867, 41164, 41241, 41275, 41550, 41590, 41591, 41592, 41594, 41602 | OPPO | 40575, 41224, 41525, 42115 |
| CAMBRIDGE AUDIO | 41471 | 41077, 41086, 41107, 41165, 41177, 41321, 41351, 41628 | 41023, 41024, 41117, 41129, 41502, 41537 | JWIN | 41049, 41051, 41469, 41675 | OPTIMUS | 40571 |
| | | 41077, 41086, 41107, 41165, 41177, 41321, 41351, 41628 | 41023, 41024, 41117, 41129, 41502, 41537 | KALEIDESCAPE | 41790 | OPTOMEDIA ELECTRONICS | 40896 |
| | | 41077, 41086, 41107, 41165, 41177, 41321, 41351, 41628 | 41023, 41024, 41117, 41129, 41502, 41537 | KAWASAKI | 40790 | ORION | 41695 |
| | | 41077, 41086, 41107, 41165, 41177, 41321, 41351, 41628 | 41023, 41024, 41117, 41129, 41502, 41537 | KENWOOD | 40490, 40534, 40682, 40737 | ORITRON | 40651 |
| | | 41077, 41086, 41107, 41165, 41177, 41321, 41351, 41628 | 41023, 41024, 41117, 41129, 41502, 41537 | KLH | 40717, 40790, 41020, 41149, 41261 | PALSONIC | 40672, 40852 |
| | | 41077, 41086, 41107, 41165, 41177, 41321, 41351, 41628 | 41023, 41024, 41117, 41129, 41502, 41537 | KLOSS | 40533 | PANASONIC | 40490, 40503, 40571, 40632, 40703, 41010, 41011, 41282, 41362, 41462, 41490, 41632, 41641, 41762 |
| | | 41077, 41086, 41107, 41165, 41177, 41321, 41351, 41628 | 41023, 41024, 41117, 41129, 41502, 41537 | KONKA | 40711, 40719, 40720, 40721 | | |
| | | 41077, 41086, 41107, 41165, 41177, 41321, 41351, 41628 | 41023, 41024, 41117, 41129, 41502, 41537 | KOSCH | 41677 | | |
| | | 41077, 41086, 41107, 41165, 41177, 41321, 41351, 41628 | 41023, 41024, 41117, 41129, 41502, 41537 | KOSS | 40651, 40769, 40896, 41061, 41423 | | |
| | | 41077, 41086, 41107, 41165, 41177, 41321, 41351, 41628 | 41023, 41024, 41117, 41129, 41502, 41537 | KREISEN | 41421 | | |
| | | 41077, 41086, 41107, 41165, 41177, 41321, 41351, 41628 | 41023, 41024, 41117, 41129, 41502, 41537 | KRELL | 41498 | | |
| | | 41077, 41086, 41107, 41165, 41177, 41321, 41351, 41628 | 41023, 41024, 41117, 41129, 41502, 41537 | LAFAYETTE | 41369 | | |
| | | 41077, 41086, 41107, 41165, 41177, 41321, 41351, 41628 | 41023, 41024, 41117, 41129, 41502, 41537 | LANDEL | 40826 | | |

| | | | | | | | |
|-----------------|---------------|----------------|---------------|-----------------------|----------------|-----------------------|---------------|
| PHILCO | 40675, 40690 | SHERWOOD | 40633, 40770, | WINTEL | 41131 | COBY | 51086 |
| PHILIPS | 40503, 40539, | | 41043, 41077, | WYSE | 41652 | CYBERHOME | 51129, 51502 |
| | 40646, 40671, | | 41889 | XBOX | 40522, 41708, | DENON | 50490 |
| | 40675, 40854, | SHINSONIC | 40533, 40839 | | 42083 | DIGITALMAX | 51738 |
| | 41260, 41267, | SIGMA DESIGNS | | XWAVE | 41001 | ELECTROHOME | |
| | 41340, 41354, | | 40674 | YAMAHA | 40490, 40497, | | 52116 |
| | 41846, 42056, | SILVERCREST | 41368 | | 40539, 40545, | EMERSON | 50675 |
| | 42084 | SLIM ART | 40784 | | 40817, 41282, | FUNAI | 50675, 51334 |
| PHONOTREND | 40699 | SM ELECTRONIC | | | 42543, 42544 | GATEWAY | 51073, 51158, |
| PIANODISC | 41024 | | 40690, 40730 | YAMAKAWA | 40872 | | 51194 |
| PIONEER | 40142, 40525, | SONIC BLUE | 40573, 40715, | ZENITH | 40503, 40591, | GO VIDEO | 50741, 51158, |
| | 40571, 40631, | | 40783, 40869, | | 40741, 40869 | | 51304, 51730 |
| | 40632, 40638, | | 41099 | ZEUS | 40784 | HITACHI | 51664, 51764 |
| | 41460, 41475, | SONY | 40533, 40772, | ZOECE | 41265 | ILO | 51348 |
| | 41476, 41512, | | 40864, 41033, | | | JVC | 51164, 51275 |
| | 41571 | | 41069, 41070, | | | KREISEN | 51421 |
| POLAROID | 41013, 41020, | | 41431, 41433, | BLU-RAY/HD DVD | | LG | 50741 |
| | 41061, 41086, | | 41516, 41533, | PLAYER | | LITEON | 51158, 51416, |
| | 41245, 41261, | | 41536, 41548, | | LG | | 51440, 51738 |
| | 41316, 41478, | | 41633 | | ONKYO | MAGNAVOX | 50646, 50675, |
| | 41480, 41482 | SOVA | 41122 | | PANASONIC | | 51506 |
| POLK AUDIO | 40539 | SUNGALE | 41074, 41342, | | PHILIPS | MITSUBISHI | 51403, 51629 |
| PORTLAND | 40770 | | 41532 | | PIONEER | NEC | 51404 |
| PRESIDIAN | 40675, 41072, | SUPERSCAN | 40821 | | RCA | PANASONIC | 50490, 51010, |
| | 41738 | SVA | 40717, 40860, | | SAMSUNG | | 51011 |
| PRIMA | 41016 | | 41105 | | SONY | PHILIPS | 50646, 51340 |
| PRIMARE | 40886, 41467, | SYLVANIA | 40675, 40821, | | TOSHIBA | PIONEER | 50631, 51460, |
| | 41618 | | 41268 | | | | 51475, 51476, |
| PRINCETON | 40674 | SYMPHONIC | 40675, 40821, | LD PLAYER | | | 51512 |
| PROCEED | 40672 | | 41268, 41334 | | AIWA | POLAROID | 51086 |
| PROSCAN | 40522 | TAG MCLAREN | | | CARVER | PRESIDIAN | 51738 |
| PROSONIC | 40699 | | 40894 | | CONQUEST | RCA | 50522 |
| PROTRON | 41461 | TATUNG | 40770 | | DENON | SAMSUNG | 50490 |
| PROVISION | 40778 | TEAC | 40571, 40692, | | | SANYO | 51583 |
| QWESTAR | 40651 | | 40717, 40790, | DISCO VISION | | SENSORY SCIENCE | |
| RADIONETTE | 40741 | | 40809 | | | | 51158 |
| RADIOSHACK | 40571 | TECHNICS | 40490, 40703 | | FUNAI | SHARP | 50630, 50675, |
| RCA | 40522, 40571, | TECHNIKA | 40770 | | HARMAN/KARDON | | 51556, 51642, |
| | 40717, 40790, | TECHNOSONIC | | | | | 52550 |
| | 40822, 41013, | | 40730 | | HITACHI | SONY | 51033, 51069, |
| | 41022, 41132, | TECHWOOD | 40692 | | KENWOOD | | 51070, 51431, |
| | 41193, 41769 | TERAPIN | 41031, 41053, | | MAGNAVOX | | 51433, 51536 |
| REALISTIC | 40571 | | 41166 | | | SYLVANIA | 50675 |
| REALMAGIC | 40674 | TEVION | 40651 | | MARANTZ | TOSHIBA | 51510, 51588, |
| REOC | 40752 | THETA DIGITAL | | | MITSUBISHI | | 51639 |
| REVOY | 40699 | | 40571 | | NAD | VICTOR | 51597, 51275 |
| RIO | 40869 | THOMSON | 40511, 40522 | | OPTIMUS | YAMAHA | 52544 |
| RJTECH | 40118, 41360, | THULE AUDIO | 41007 | | PANASONIC | ZENITH | 50741 |
| | 41376 | TIVO | 41503, 41512, | | PHILIPS | | |
| ROTEL | 40623, 41178, | | 41588 | | PIONEER | | |
| | 41734 | TOSHIBA | 40503, 40539, | | | CD PLAYER | |
| ROWA | 40823, 41004 | | 40573, 40695, | | POLK AUDIO | ACOUSTIC RESEARCH | |
| SABA | 40651 | | 41045, 41154, | | QUASAR | | 60420 |
| SAMPO | 40698, 40752, | | 41503, 41510, | | REALISTIC | ADC | 60018 |
| | 41501 | | 41515, 41588, | | SEGA | ADCOM | 60234 |
| SAMSUNG | 40199, 40490, | | 41595, 41608, | | SHARP | ADMIRAL | 60305 |
| | 40573, 40744, | | 41639, 41769 | | SONY | AIWA | 60157 |
| | 40820, 40899, | TREDEX | 40799, 40800, | | TECHNICS | AKAI | 60083, 60643, |
| | 41044, 41075, | | 40803, 40804 | | THETA DIGITAL | | 61688 |
| | 41470, 41599, | UNIMAX | 40770 | | | ALBA | 60625 |
| | 42069 | UNITED | 40730 | | TOSHIBA | ANAM NATIONAL | |
| SANSUI | 40695, 41695 | UNIVERSUM | 40591 | | VICTOR | | 60362 |
| SANYO | 40670, 40675, | URBAN CONCEPTS | | | WARDS | ARCAM | 60157 |
| | 40695, 40873, | | 40503, 40539 | | YAMAHA | AUDIO PRO | 60437 |
| | 41334, 41583 | US LOGIC | 40839 | | | AUDIO RESEARCH | |
| SCHNEIDER | 40783 | V | 41064, 41126, | DVD RECORDER | | | 60157 |
| SCHWAIGER | 40752 | | 41226 | | ACCURIAN | BURMESTER | 60420 |
| SENSORY SCIENCE | | VENTURER | 40790 | | APEX DIGITAL | CAIRN | 60157 |
| | 41158 | VIALTA | 41509 | | | CALIFORNIA AUDIO LABS | |
| SHARP | 40630, 40675, | VICTOR | 41241, 41597 | | ASPIRE DIGITAL | | 60029, 60303 |
| | 40752, 41256, | VIEWMAGE | 41374 | | | CAMBRIDGE AUDIO | |
| | 41556, 41642, | VIZIO | 41064, 41126, | | | | 61731 |
| | 42550 | | 41226 | | ASTAR | CAMBRIDGE SOUNDWORKS | |
| SHARPER IMAGE | | VOCOPRO | 41027, 41360 | | BROKSONIC | | 60157 |
| | 41117 | WESDER | 40699 | | CITIZEN | | 52116 |

| | | | | | | |
|---------------|--|---------------|---|---------------|--|------------------------|
| FISHER | 80008, 80219, 80360, 80797, 81409, 81801 | OPTIMUS | 80014, 80074, 80080, 80121, 80158, 80163, 80177, 80186, 80195, 80219, 80531, 80670, 80797, 80849, 81023, 81074 | SONIC BLUE | 81383, 81869 | |
| FOSGATE | 81487 | | | SONY | 80158, 80168, 81058, 81131, 81258, 81367, 81371, 81382, 81406, 81441, 81458, 81503, 81529, 81558, 81622, 81658, 81758, 81759, 81858 | |
| GARRARD | 80281, 80424, 80463 | | | SOUNDESIGN | 80670 | |
| GATEWAY | 81567 | | | STEREOPHONICS | | |
| GLORY HORSE | 81263 | ORITRON | 81366, 81497 | | 81023 | |
| GOLDSTAR | 80281 | OUTLAW | 80391, 81487 | SUNFIRE | 81313 | |
| GOODMANS | 80797 | PANASONIC | 80039, 80309, 80367, 81275, 81288, 81308, 81316, 81350, 81363, 81509, 81518, 81548, 81633, 81675, 81763, 81764, 82967 | SYLVANIA | 80797 | |
| GPX | 81299 | | | TEAC | 80163, 80463, 81074, 81267, 81390, 81528 | |
| GRUNDIG | 80189, 80281, 81387 | PENNEY | 80039, 80195 | TECHNICS | 80039, 80208, 80309, 81308, 81384, 81518, 81633, 81675 | |
| HARMAN/KARDON | 80110, 80189, 80891, 81289, 81304, 81306 | PHILIPS | 80189, 80391, 80891, 81189, 81266, 81268, 81269, 81283, 81365, 81368 | TECHWOOD | 80281 | |
| HITACHI | 80386, 81273, 81801 | PIONEER | 80014, 80080, 80150, 80281, 80346, 80531, 80630, 81023, 81123, 81284, 81343, 81384, 81678, 81823, 81935, 81986 | THORENS | 81189 | |
| INSIGNIA | 81030, 81077 | | | TOSHIBA | 80080, 80135, 80842, 81123, 81788 | |
| INTEGRA | 80135, 80842, 81298, 81320, 81805 | | | VENTURER | 80849, 81390 | |
| JBL | 80110, 81306 | | | VICTOR | 80074 | |
| JVC | 80074, 80262, 80464, 81058, 81263, 81282, 81374, 81495, 81643, 81665, 81811 | POLK AUDIO | 80189, 81289, 81414 | WARDS | 80014, 80080, 80158, 80189 | |
| KAWASAKI | 81390 | PROCEED | 81922 | XM | 81406, 81414, 81846 | |
| KENWOOD | 80027, 80077, 80186, 80262, 81313, 81363, 81569, 81570, 81770 | PROSCAN | 81254 | YAMAHA | 80176, 80186, 80376, 81023, 81176, 81276, 81331, 81375, 81476, 81815, 81949, 82176, 82177, 82178, 82179, 82908, 82915, 82918, 82919 | |
| KLH | 81390, 81428 | QUASAR | 80039 | | YBA | 81921 |
| KOSS | 80424, 81366, 81497 | RADIOSHACK | 81263, 81609 | | YORX | 80195 |
| LEXICON | 81076 | RCA | 80080, 80346, 80360, 80530, 80531, 81023, 81074, 81123, 81254, 81390, 81511, 81609 | | ZENITH | 80281, 80346, 80857 |
| LG | 80281 | | | | | |
| LINN | 80189 | REALISTIC | 80121, 80158, 80163, 80177, 80186, 80195, 81609 | | | |
| LIQUID VIDEO | 81497 | REVOX | 80189 | | | |
| LLOYD'S | 80195 | RIO | 81383, 81869 | | | |
| MAGNAVOX | 80128, 80189, 80195, 80391, 80531, 81189, 81266, 81269, 81514 | SAMSUNG | 81295, 81304, 81500 | | | |
| MARANTZ | 80039, 80128, 80189, 80200, 80891, 81189, 81269, 81289, 81671 | SANGEAN | 82165 | | | |
| MCINTOSH | 81289 | SANSUI | 80148, 80189, 80346, 81092, 81189, 81764 | | | |
| MCS | 80039, 80346 | | | | | |
| MICROMEGA | 80189, 81189 | SANYO | 80219, 80360, 81251, 81801 | | | |
| MITSUBISHI | 81393, 81920, 81921, 81922, 81957 | SCOTT | 80163, 80322 | | | |
| MODULAIRE | 80195 | SEARS | 80195, 80424 | | | |
| MYRYAD | 81189 | SHARP | 80186, 80262, 81286, 81361, 81386 | | | |
| NAD | 80320 | SHARPER IMAGE | 80797, 81263, 81385, 81409, 81410, 81411, 81416 | | | |
| NAKAMICHI | 80097, 80347, 81092, 81313, 81555 | | | | | |
| NEC | 80235 | SHERWOOD | 81077, 81423, 81567 | | | |
| NIKKO | 80322 | SIRIUS | 81602, 81627, 81770, 81811, 81987 | | | |
| NIKKODO | 80322 | | | | | |
| ONKYO | 80135, 80380, 80842, 81298, 81320, 81677, 81805 | SONIC | 80281 | | | |

OTHER AUDIO ACCESSORIES

| | | |
|--------|-------------------------|-------|
| YAMAHA | 82981, 82982, (iPod) | 82983 |
|--------|-------------------------|-------|



© 2008 YAMAHA CORPORATION All rights reserved.

YAMAHA ELECTRONICS CORPORATION, USA 6660 ORANGETHORPE AVE., BUENA PARK, CALIF. 90620, U.S.A.
YAMAHA CANADA MUSIC LTD. 135 MILNER AVE., SCARBOROUGH, ONTARIO M1S 3R1, CANADA
YAMAHA ELECTRONIK EUROPA G.m.b.H. SIEMENSSTR. 22-34, 25462 RELINGEN BEI HAMBURG, GERMANY
YAMAHA ELECTRONIQUE FRANCE S.A. RUE AMBROISE CROIZAT BP70 CROISSY-BEAUBOURG 77312 MARNE-LA-VALLEE CEDEX02, FRANCE
YAMAHA ELECTRONICS (UK) LTD. YAMAHA HOUSE, 200 RICKMANSWORTH ROAD WATFORD, HERTS WD18 7GQ, ENGLAND
YAMAHA SCANDINAVIA A.B. J A WETTERGRENS GATA 1, BOX 30053, 400 43 VÄSTRA FRÖLUNDA, SWEDEN
YAMAHA MUSIC AUSTRALIA PTY, LTD. 17-33 MARKET ST., SOUTH MELBOURNE, 3205 VIC., AUSTRALIA

YAMAHA CORPORATION
Printed in Malaysia ◀ WN24840

The circled numbers and alphabets correspond to those in the Owner's Manual.

■ Front panel

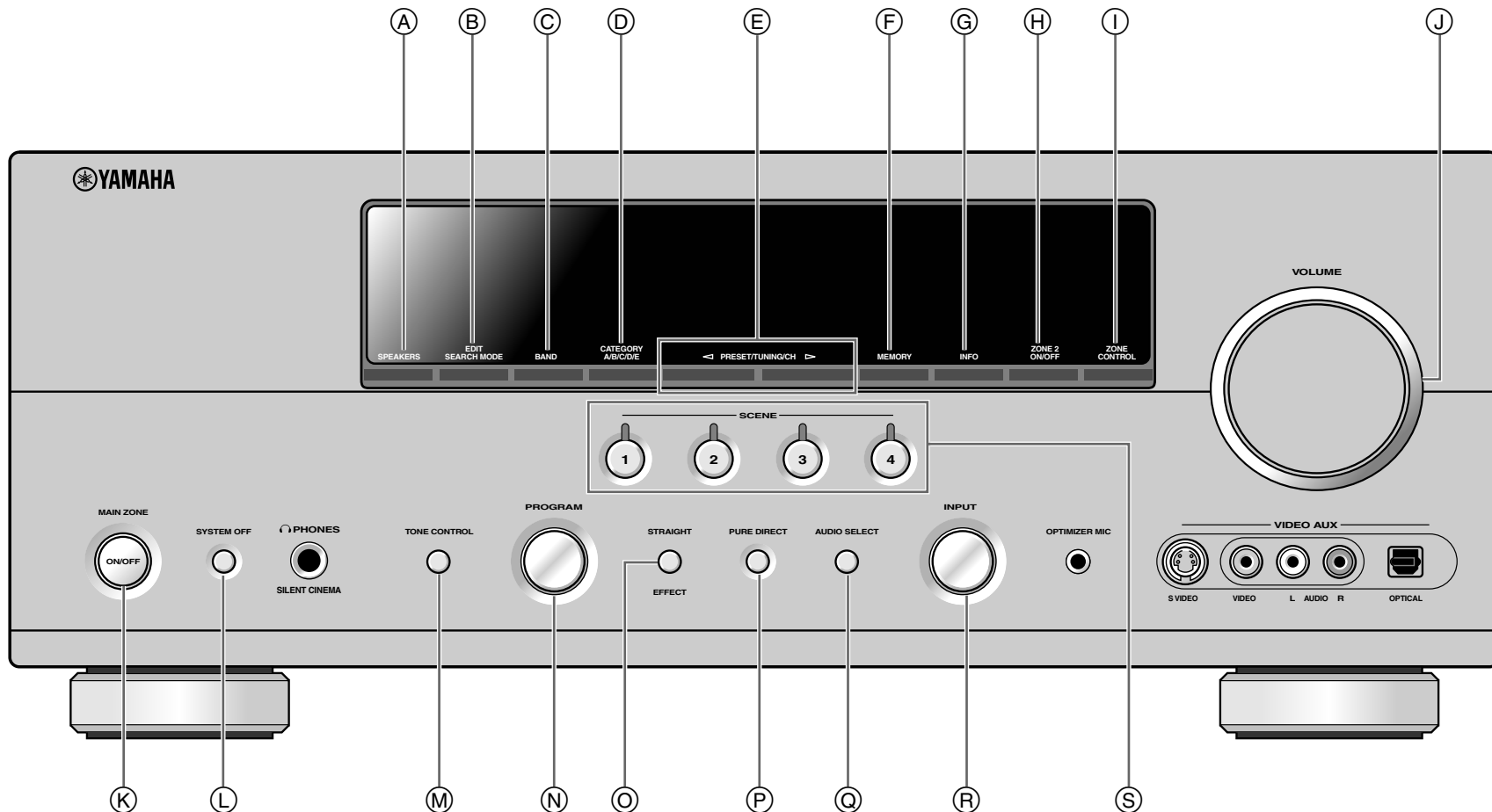

Remote control

