

ZANUSSI

TUMBLE DRYER TDS 372T

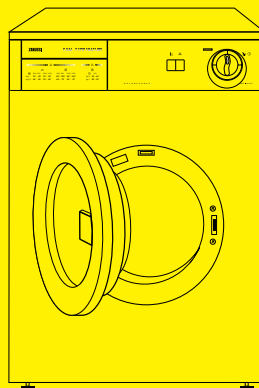

CONTENTS

Warnings	Page	3
Description of the appliance	Page	4
Installation	Page	5
■ Positioning	Page	5
■ Fitting the vent hose	Page	5-6
■ Door reversal	Page	7
■ Stacking kit	Page	7
■ Electrical connection	Page	8
Use	Page	9
■ Control panel	Page	9
■ Use of controls	Page	9
■ Drying Times	Page	10
■ Drying sequence	Page	11
■ Useful hints	Page	12
Maintenance	Page	13
■ External cleaning	Page	13
■ Cleaning the door	Page	13
■ Cleaning the filter	Page	13
Servicing	Page	14

TECHNICAL SPECIFICATIONS

DIMENSIONS	Height	85 cm
	Width	60 cm
	Depth	57 cm
ELECTRICAL CONNECTION	Voltage/Frequency	220-230 V/50 Hz
	Max. power absorbed	2200 W (10A)
DRYING CAPACITY	Cotton, linen	5 kg
	Synthetics	2 kg

CE This appliance complies with the following E.E.C. Directives:
- 73/23 EEC of 19.2.73 (Low Voltage Directive) and subsequent modifications;
- 89/336 EEC of 3.5.89 (Electromagnetic Compatibility Directive) and subsequent modifications.



WARNINGS

It is most important that this instruction book should be retained with the appliance for future reference. Should the appliance be sold or transferred to another owner, or should you move house and leave the appliance, always ensure that the book is supplied with the appliance in order that the new owner can get to know the functioning of the appliance and the relevant warnings.

- **These warnings have been provided in the interest of safety. You MUST read them carefully before installing or using the appliance.**

INSTALLATION

- Any electrical work required to install this appliance should be carried out by a qualified electrician or competent person.
- Make sure that the appliance does not stand on its electrical supply cable.
- If the machine is situated on a carpeted floor, please adjust the feet in order to allow air to circulate freely.
- This tumble dryer is designed to be vented through to the open air. It should have its own ventilation system which should not be joined with any other ventilation system connected to any other appliance.

USE

- Always unplug the appliance after use.
- Clothes which are dripping wet should not be placed in the dryer. Always load well spun laundry. The higher the spin speed, the lower the electricity consumption and the shorter the drying times.
- **Never tumble dry items that have been in contact with chemicals such as dry cleaning fluid. These are of a volatile nature and could cause an explosion.**
- As some bulky items such as duvets and eiderdowns should be dried in large commercial machines because of their bulk, check with the manufacturer of the item if it is suitable for drying in a domestic machine, even if the dry weight of the item is within the limit advised.
- Always check that no cigarette lighters have been left in pockets.
- Leave the porthole door slightly ajar when not in use to preserve the door seal.
- The fluff filter must be cleaned after every use.

- Do not operate the appliance with a damaged filter as this may cause a fire.
- Do not overload the appliance.
- Do not allow fluff to accumulate around the dryer.

SERVICE/REPAIR

- Under no circumstances should you attempt to repair the machine yourself. Repairs carried out by inexperienced persons may cause injury or serious malfunctioning. Refer to your local Zanussi Service Centre. Always insist on genuine Zanussi spare parts.

GENERAL SAFETY

- It is dangerous to modify or try to modify the specifications of this appliance in any way.
- This appliance is designed to be used by adults. Children should not be allowed to touch the controls or play with the product.
- Pets and small children may climb into tumble dryers. Check your appliance each time before use.



ENVIRONMENT PROTECTION

- The materials used on this appliance marked with the symbol  are recyclable. This means that they can be recycled by disposing of them properly in appropriate collection containers.
- If you take your appliance to a refuse disposal site, cut off the power cable flush with the appliance to avoid the danger of the appliance being re-used, and disable the door catch to prevent children becoming trapped inside.

DESCRIPTION OF THE APPLIANCE

- 1 Worktop
- 2 Programme chart
- 3 Low Temperature Button
- 4 Cool Tumbling Button
- 5 Mains-On Light
- 6 Drying Time Selector Dial
- 7 Rating Plate
- 8 Door Handle
- 9 Fluff filter
- 10 Adjustable feet

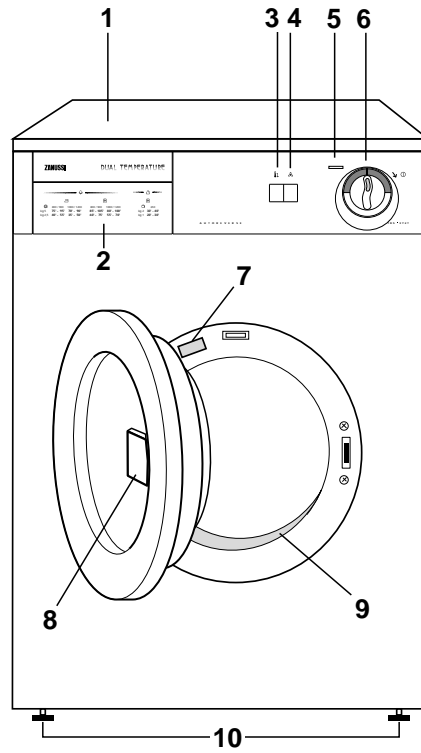

- 11 Side vent outlets
- 12 Ring nut
- 13 Rear vent outlet

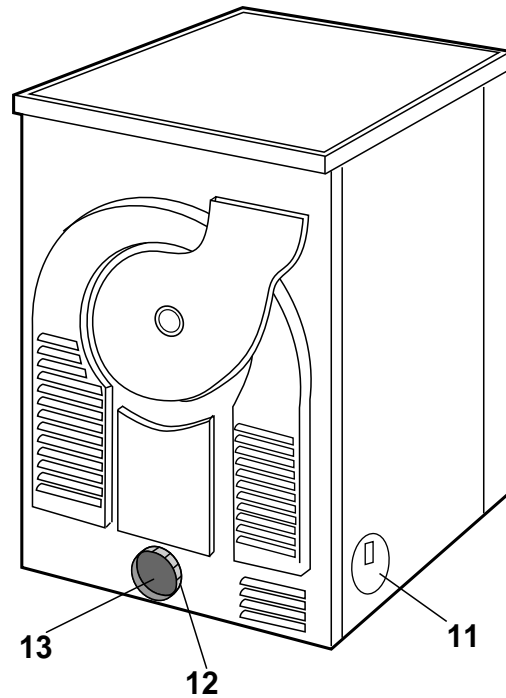

INSTALLATION

Positioning

It is recommended that, for your convenience, the machine is positioned close to your washing machine.

Whilst drying, the tumble dryer will expel a certain amount of warm, very moist air, and this should be removed from the room as quickly as possible to prevent condensation. In an extremely well ventilated room or close to an open window, this may occur naturally.

However, in general, it is better to carry the dryer's exhaust outside via a 100 mm diameter flexible hose (available through your dealer); ending either temporarily at an open window, or permanently at a fixed ventilation grille, fitted to an exterior wall or window.

The tumble dryer must be installed in a clean place, where dirt does not build up.

Make sure there are no obstructing items or material near the air-intake louvres provided at the back (e.g. paper, rags etc.).

To keep vibration and noise to a minimum when the dryer is in use, it should be placed on a firm, level surface.

Once in its permanent operating position, check that the dryer is absolutely level with the aid of a spirit level. If it is not, raise or lower the two adjustable feet at the front of the machine until it is.

The feet must never be removed.

Do not restrict the floor clearance through deep-pile carpets, strips of wood or similar. This might cause heat build-up which would interfere with the operation of the appliance.

Important

When operating the tumble dryer, the room temperature must not exceed 35°C, as it may affect the performance of the appliance.

Fitting the vent hose

To simplify the installation, there is a choice of vent outlets: one at the back, the others in the left and right-hand side.

Connect the hose to whichever is the more convenient by pulling the ring nut (A) from the vent outlet at the back, screwing it on to the hose and pushing it firmly back into place.

The unused vents should now be sealed with the special snap covers provided.

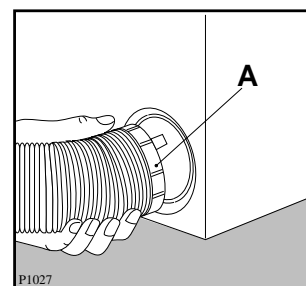
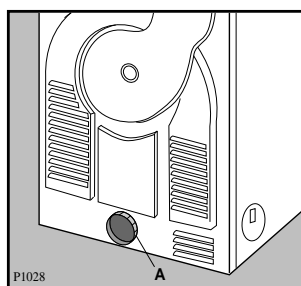
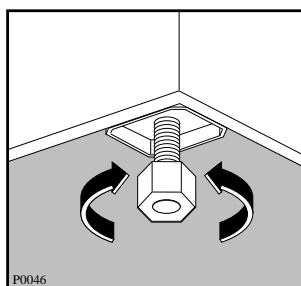

Advice: If the hose is long and the room temperature low, the moisture might condense to water inside the hose. **This is an unavoidable natural phenomenon.** To prevent this water from lying in the hose or flowing back into the tumble dryer, it is advisable to drill a small hole (dia. 3 mm) in the lowest point of the hose and to place a small container below it. (See picture, point A).

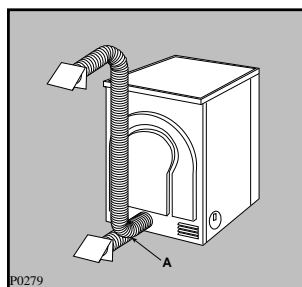

Once connected to the dryer, run the vent hose to the desired outlet point, ensuring that the run's overall length is less than 2 m, and that it contains no more than two bends. As to the outlet itself, if you have decided on a fixed wall/window grille, a good local builder's merchant should be able to supply you with the necessary fittings and installation advice.



It is important not to connect the vent hose to, for example, a cooker hood, or a chimney or flue pipe designed to carry the exhaust from a fuel burning appliance.

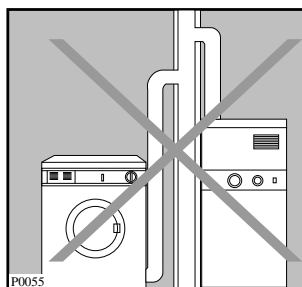

Note that to avoid condensation problems, it is essential that the dryer be fitted with the flexible hose to carry its "exhaust" at least beyond the kitchen units; preferable outside the kitchen.

In order to prevent the appliance from overheating, it is important that the steam exhaust is unobstructed.

Therefore, in case of a permanent hose fitted to an exterior wall or ceiling, it must be ensured an exhaust capacity of at least 150 m³/h.

If the dryer is fitted next to kitchen units, make sure that the vent hose is not squashed. If the hose is partially squashed, drying efficiency will be reduced, resulting in longer drying times and higher energy consumption.

If the hose is completely squashed, the safety cut-outs with which the machine is fitted may operate.

Door reversal

To make it easier to load or unload the laundry the door can be reversed.

This operation must be carried out by qualified personnel.

Operate as follows:

- Remove the door by unscrewing the two screws (1) fastening the hinge to the cabinet (Fig. A).
- Remove the safety catch (2) and the plug (3) by bending the two fastening tags (Fig. A).
- Refit the safety catch (2) and plug (3) on the door by reversing their positions (Fig. B).
- Remove the plastic plate (4) by unscrewing the two fastening screws (Fig. A).
- Refit the plastic plate (4) on the opposite side (Fig. B).
- Refit the door by screwing in the two screws (1) which fasten the door to the cabinet (Fig. B).

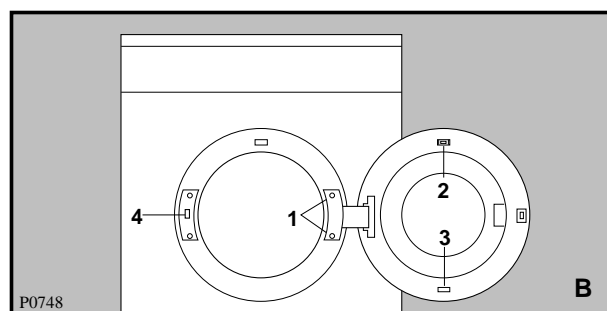
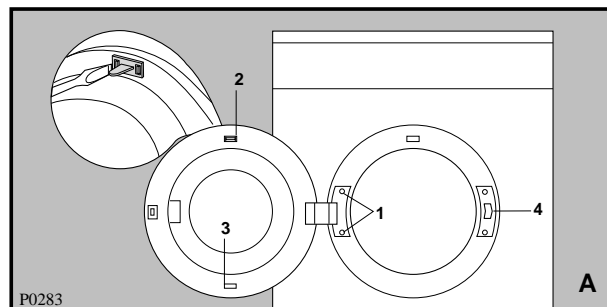

Stacking kit

A special stacking kit is available through your dealer, to enable the mounting of the dryer on top of your washing machine.

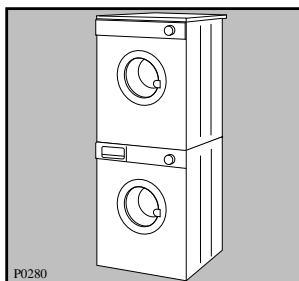

Electrical connection

This machine is designed to operate on a 220-230 V, single-phase, 50 Hz supply.

Check that your domestic electrical installation can take the maximum load required (2.2 kW), also taking into account any other appliances in use.



WARNING: THIS APPLIANCE MUST BE EARTHED.

The manufacturer declines any liability should this safety measure not be observed.

The appliance is supplied with a 13amp plug fitted.

In the event of having to change the fuse in the plug supplied, a 13amp ASTA approved (BS1363A) fuse must be used.

Should the plug need to be replaced for any reason, proceed as described below.

The wires in the mains lead are coloured in accordance with the following code:

Green and Yellow	- Earth
Blue	- Neutral
Brown	- Live

The wire coloured green and yellow must be connected to the terminal marked with the letter «E» or by the earth symbol \perp or coloured green and yellow.

The wire coloured blue must be connected to the terminal «N» or coloured black.

The wire coloured brown must be connected to the terminal marked «L» or coloured red.

Upon completion there must be no cut, or stray strands of wire present and the cord clamp must be secure over the outer sheath.

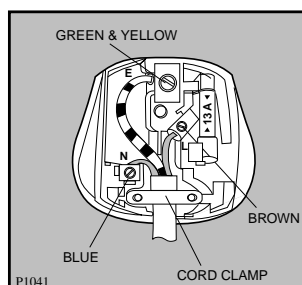

WARNING:

A cut off plug inserted into a 13 amp socket is a serious safety (shock) hazard.

Ensure that the cut off plug is disposed of safely.

Control panel

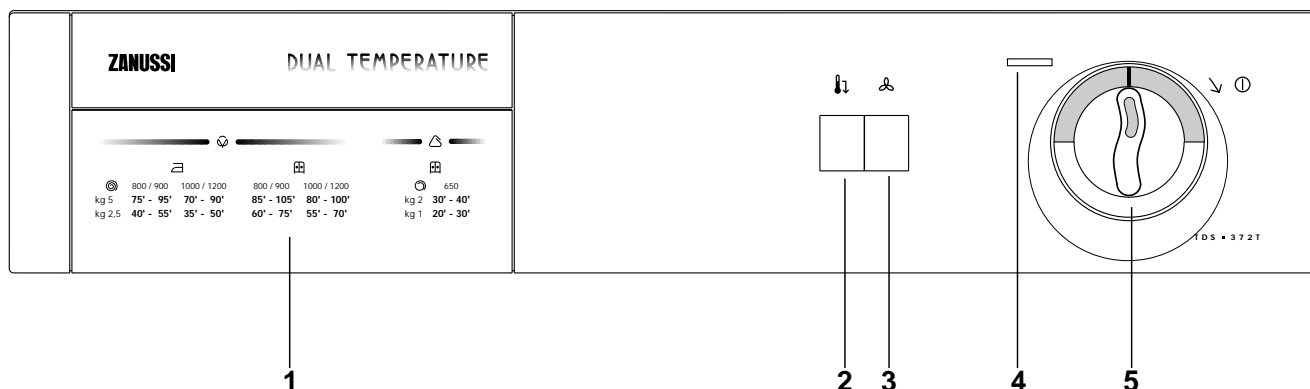

1 Programme Chart

This will help you to select the correct time for drying.

2 Low Temperature Button

Press this button to reduce the temperature when drying particularly delicate cotton or linen items. In this case you should select a longer drying time.

On the programmes for synthetics the temperature is automatically reduced. Therefore it is not necessary to depress this button.

3 Cool Tumbling Button

By depressing this button the heat is cut off. This is particularly useful to freshen the laundry (e.g. to remove a persistent odour of moth-balls).

4 Mains-On Light

This lights up when the machine starts operating and goes out at the end of the programme.

5 Drying Time Selector Dial

The selector dial incorporates two drying cycles, one of up to 120 minutes at a high temperature for cotton and linen, and one of up to 80 minutes at a low temperature for synthetic fabrics.

To set the machine to the selected time, turn the dial **clockwise** until the time you want coincides exactly with the pointer.

NEVER attempt to turn the dial in an anticlockwise direction.

When selecting the drying time, you should remember that it includes a 8 minute cooling phase (position  on the dial).

This phase should not be shortened, stopped or avoided, as this could cause skin burns or damages to the laundry.



Additional drying

If at the end of the programme the laundry is still too damp, set the dial for a further period of drying (remembering to take into account the cooling period).

Drying Times



Cotton and Linen

Selector dial: up to 120 minutes

Degree of drying required	Degree of spin given rpm	Quantity kg	Drying times mins
Store dry 	800-900	5	85-105
		2.5	60-75
	1000-1200	5	80-100
		2.5	55-70
Iron dry 	800-900	5	75-95
		2.5	40-55
	1000-1200	5	70-90
		2.5	35-50

Synthetics

Selector dial: up to 80 minutes

Degree of drying required	Degree of spin given rpm	Quantity kg	Drying times mins
Store dry 	650	2	30-40
		1	20-30
		0.5	20-25
Iron dry 	650	2	25-35

Never overfill the drum (do not load large quilts, for example).

The laundry must be suitably spin dried in your washing machine before being placed in the tumble dryer (500rpm minimum).

Drying times vary according to:

- The type of laundry
- The size of the load
- The degree of spinning prior to drying

Drying times are given as a guide only. Experience will soon enable you to estimate the drying time needed for your usual laundry loads.

Do not start by selecting a long drying time. It is better to determine the required degree of dryness by gradually increasing the drying time.

For a mixed load (cotton and resistant synthetics, for example) select the time for the most delicate fibres and increase it by 10 mins.

i Drying sequence

Before starting up for the first time it is advisable to load a few moist cloths into the dryer and to let it run for about 20 minutes. This ensures that no dust and dirt is left in the drum.

1. Load the laundry

Open the door by pulling the catch forwards.

Load the items one at a time, shaking them out loosely and close the door.

Please check the laundry does not get caught between the door and filter.

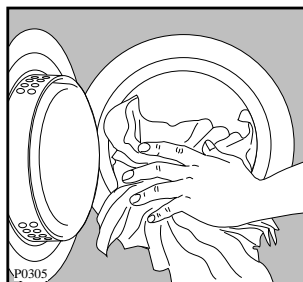

2. Select the required option

Depress Cool Tumbling or Low Temp. Button, if desired.

3. Select the drying time

Turn the selector dial clockwise to the desired time, in the high or low temperature section, depending on the laundry: the mains-on light illuminates and the machine starts operating.

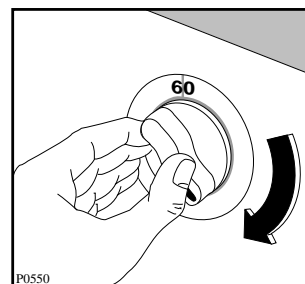
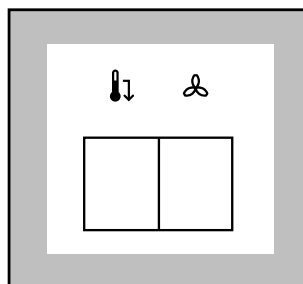

4. When drying is completed

The machine stops automatically, the mains-on light goes out.

If the laundry is still too damp, select a further brief drying time, bearing in mind that during the last 8 minutes the dryer carries out the cooling and anti-crease treatment phase.



**Clean the filter after every drying programme.
A clean filter ensures correct functioning of the appliance.**



Useful hints

- Try to load to the maximum capacity of the machine as small loads are uneconomical. For information, here is a list of the average weights of some common laundry items.

Sheet	700 - 1000 g
Tablecloth	400 - 500 g
Kitchen towel	70 - 120 g
Table napkin	50 - 100 g
Towelling hand towel	150 - 250 g
Bathrobe	1000 - 1500 g
Man's shirt	200 - 300 g
Pillowcase	100 - 200 g
Man's pyjamas	400 - 500 g
Ladies' nightdress	200 - 250 g

- Never tumble dry the following:
Particularly delicate items such as net curtains, woollen, silk, fabrics with metal trim, nylon tights, bulky materials such as anoraks, blankets, eiderdowns, sleeping bags, feather quilts and any items containing rubber foam or materials similar to rubber foam.
- Always follow the instructions on garment labels.
 -  normal drying (high temperature)
 -  delicate drying (low temperature)
 -  do not tumble dry
- Close pillowcases and covers with fasteners to prevent small laundry items getting tangled inside them. Close press studs, zips and hooks and tie belts and apron strings.
- Sort laundry according to type and degree of drying required.
- Do not over-dry laundry, this avoids creasing and saves energy.
- Avoid drying dark clothes with light coloured fluffy items such as towels as they could attract the fluff.
- The laundry must be thoroughly spun before tumble drying.
- **Easy-care items**, too, e.g. shirts, should be briefly pre-spun before drying (depending on crease resistance approx. 30 seconds or using the special brief spin programme of your washing machine).

- Knitted textiles (knitted underwear) may shrink a little during drying. Please **do not** overdry items of this type. It is advisable to allow for shrinkage when choosing the size of new purchases.
- You can also put starched items into your dryer. However, to achieve the desired starched effect, choose the programme "iron dry". To remove any starch residues, wipe out the internal drum after drying with a moist cloth and then rub it dry.
- To avoid a static charge when drying is completed, use either a fabric softener when you are washing the laundry or a fabric conditioner specifically for tumble dryers.
- Remove the laundry when the dryer has finished drying.
- If individual items are still damp after drying, set a brief post-drying time, but **at least 20 minutes**. This will be necessary particularly for multilayered items (e.g. collars, pockets, etc.).

MAINTENANCE

You must **disconnect** the appliance from the electricity supply, before you can carry out any cleaning or maintenance work.

External cleaning

Use only soap and water and then dry thoroughly.

From time to time, apply a little wax furniture cream with a soft cloth.

Important: do not use methylated spirit, diluents or similar products.

Cleaning the door

Clean periodically the interior part of the door to remove any fluff.

Accurate cleaning ensures correct drying.

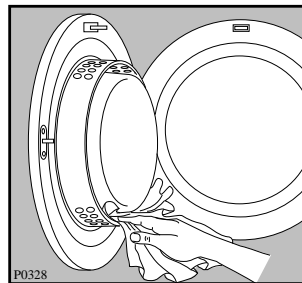

Cleaning the filter

Your dryer will only function well if the filter is clean.

The filter collects all the «fluff» which accumulates during drying and it must therefore be cleaned at the end of each programme with a damp cloth.

The filter cannot be removed.

Do not be alarmed by the amount of fluff. It is not due to excessive wear caused by the dryer. All fabric loses fluff when drying but it goes unnoticed in the air. In a tumble dryer it simply collects in the filter.

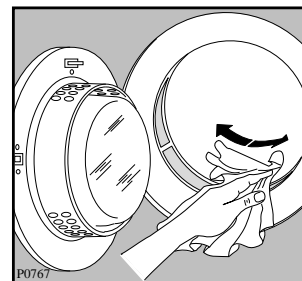

SERVICING

Before contacting your local Zanussi Service Centre, please make the following checks:

The dryer does not start up

- The door is open.
- The plug is not fitted into the wall socket.
- There is no electricity supply from the wall socket.
- The time selector dial is not set correctly.

The dryer does not dry properly

- The filter is clogged.
- Insufficient drying time.
- The selected cycle is not suitable for the laundry.
- Excessive laundry load.
- The dryer is not correctly installed.

If, after the above checks, there is still a fault, call your local Zanussi Service Centre.

Please make sure you give the model and serial number of the appliance.

This information can be found on the rating plate (see picture) or on the guarantee card.

