

INSTALLATION AND INSTRUCTION MANUAL
INSTRUÇÕES DE INSTALAÇÃO E UTILIZAÇÃO

INSTRUCCIONES PARA INSTALACION Y USO

ZANUSSI

**TUMBLE DRYER
SECADORA
SECADOR**

TCS 674 E

CONTENTS

Warnings	Page	3
Description of the appliance	Page	4
Installation	Page	5
■ Positioning	Page	5
■ Door reversal	Page	6
■ Electrical connection	Page	6
■ Stacking kit	Page	6
Use	Page	7
■ Control panel	Page	7
■ Use of controls	Page	7
■ Programme table	Page	9
■ Drying sequence	Page	10
■ Useful hints	Page	11
Maintenance	Page	12
■ External cleaning	Page	12
■ Cleaning the filter	Page	12
■ Cleaning the condenser	Page	13
■ Emptying water container	Page	13
Servicing	Page	14



TECHNICAL SPECIFICATIONS

DIMENSIONS

Height	85 cm
Width	60 cm
Depth	60 cm

ELECTRICAL CONNECTION

Voltage	220-230 V/50 Hz
Max. power absorbed	2200 W (10A)

DRYING CAPACITY

Cotton, linen	5 kg
Synthetics	2 kg



This appliance complies with the following E.E.C. Directives:
- 73/23 EEC of 19.2.73 (Low Voltage Directive) and subsequent modifications;
- 89/336 EEC of 3.5.89 (Electromagnetic Compatibility Directive) and subsequent modifications.



WARNINGS

It is most important that this instruction book should be retained with the appliance for future reference. Should the appliance be sold or transferred to another owner, or should you move house and leave the appliance, always ensure that the book is supplied with the appliance in order that the new owner can get to know the functioning of the appliance and the relevant warnings.

*These warnings have been provided in the interest of safety. You **MUST** read them carefully before installing or using the appliance.*

INSTALLATION

- Any electrical work required to install this appliance should be carried out by a qualified electrician or competent person.
- Make sure that the appliance does not stand on its electrical supply cable.
- If the machine is situated on a carpeted floor, please adjust the feet in order to allow air to circulate freely.

USE

- Always unplug the appliance after use.
- Clothes which are dripping wet should not be placed in the dryer.
Always load well spun laundry. The higher the spin speed, the lower the electricity consumption and the shorter the drying times.
- **Never tumble dry items that have been in contact with chemicals such as dry cleaning fluid. These are of a volatile nature and could cause an explosion.**
- As some bulky items such as duvets and eiderdowns should be dried in large commercial machines because of their bulk, check with the manufacturer of the item if it is suitable for drying in a domestic machine, even if the dry weight of the item is within the limit advised.
- Always check that no cigarette lighters have been left in pockets.
- Leave the door slightly ajar when not in use to preserve the door seal.
- The fluff filter must be cleaned after every use.
- Do not operate the appliance with a damaged filter or without filter as this may cause a fire.
- Do not overload the appliance.

- Do not allow fluff to accumulate around the dryer.
- Do not dry canvas shoes or sports shoes, as they could get stuck between the door and the drum, thus blocking the latter.

SERVICE/REPAIR

- Under no circumstances should you attempt to repair the machine yourself. Repairs carried out by inexperienced persons may cause injury or serious malfunctioning. Refer to your local Zanussi Service Centre. Always insist on genuine Zanussi spare parts.

GENERAL SAFETY

- It is dangerous to modify or try to modify the specifications of this appliance in any way.
- This appliance is designed to be used by adults. Children should not be allowed to touch the controls or play with the product.
- Pets and small children may climb into tumble dryers. Check your appliance each time before use.



ENVIRONMENT PROTECTION

- The materials used on this appliance marked with the symbol  are recyclable. This means that they can be recycled by disposing of them properly in appropriate collection containers.
- If you take your appliance to a refuse disposal site, cut off the power cable flush with the appliance to avoid the danger of the appliance being re-used, and disable the door catch to prevent children becoming trapped inside.

DESCRIPTION OF THE APPLIANCE

- 1 Top cover
- 2 Water container/programme chart
- 3 Door opening button
- 4 Low temperature button
- 5 Buzzer OFF button
- 6 Start button
- 7 Control lights
- 8 Programme selector dial
- 9 Mains-on light
- 10 Fluff filter
- 11 Lock
- 12 Rating plate
- 13 Ventilation grid
- 14 Condenser
- 15 Adjustable feet

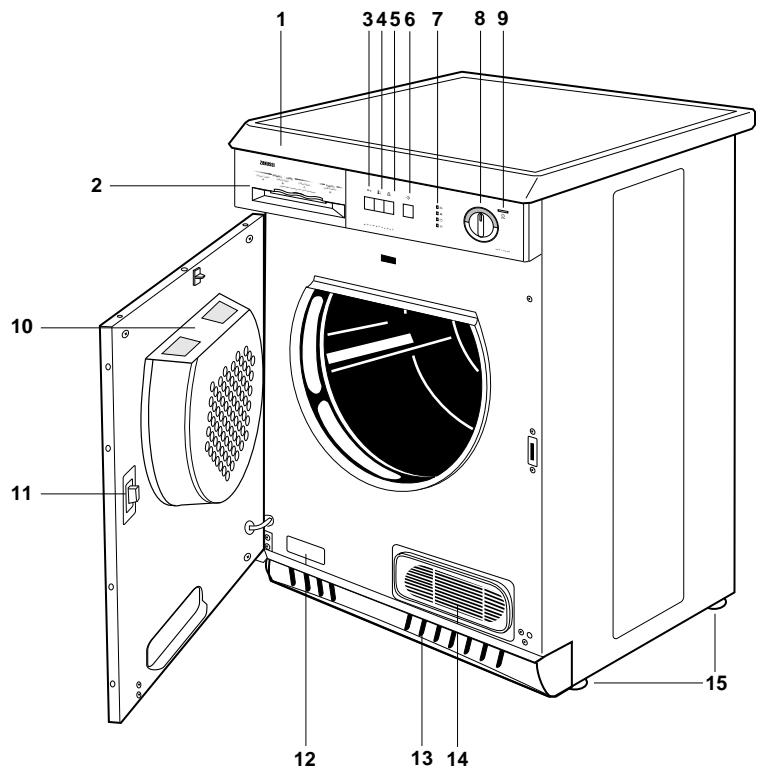

INSTALLATION

Positioning

It is recommended that, for your convenience, the machine is positioned close to your washing machine.

The tumble dryer must be installed in a clean place, where dirt does not build up.

Air must be able to circulate freely all round the appliance. Do not obstruct the front ventilation grille or the air intake grilles at the back of the machine.

To keep vibration and noise to a minimum when the dryer is in use, it should be placed on a firm, level surface.

Once in its permanent operating position, check that the dryer is absolutely level with the aid of a spirit level. If it is not, raise or lower the feet until it is.

The feet must never be removed.

Do not restrict the floor clearance through deep-pile carpets, strips of wood or similar. This might cause heat build-up which would interfere with the operation of the appliance.

Important

The hot air emitted by the tumble dryer can reach temperatures of up to 60°C. The appliance must therefore not be installed on floors which are not resistant to high temperatures.

When operating the tumble dryer, the room temperature must not exceed 35°C, as it may affect the performance of the appliance.

Door reversal

To make it easier to load or unload the laundry the door can be reversed.

This operation must be carried out by qualified personnel.

Please contact the nearest Zanussi Service Centre.

Electrical connection

This machine is designed to operate on a 220-230 V, single-phase, 50 Hz supply.

Check that your domestic electrical installation can take the maximum load required (2.2 kW), also taking into account any other appliances in use.

Connect the machine to an earthed socket, in accordance with current wiring regulations.



The manufacturer declines any responsibility for damage or injury through failure to comply with the above safety precaution.

Stacking kit

A special stacking kit is available through your dealer, to enable the mounting of the dryer on top of your washing machine.

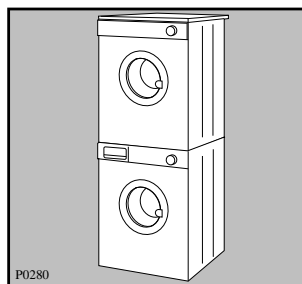

Control panel

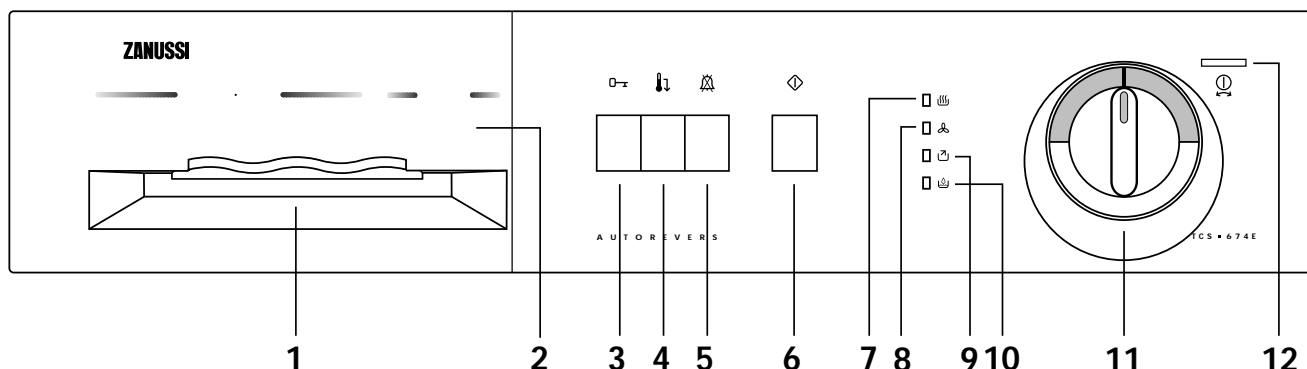

1 Programme Chart

This will help you to select the correct time or programme for drying.

2 Water container

When the tumble dryer is being used, condensation is collected in a special container. To empty container, please refer to 'Maintenance' chapter.

3 Door opening button

To open door, press this button. Should the door be opened while appliance is working, the tumble dryer will stop functioning. Press start button to resume drying after closing the door.

4 Low Temperature Button

Press this button to reduce the temperature when **drying synthetics with a time controlled programme.**

5 Buzzer OFF button

The buzzer will sound after drying (during the anti-crease phase) for 30 minutes unless it is switched off by depressing this button.

Important: When the water container is full, the buzzer will sound for 1 minute, **even** if you have depressed the button .

6 Start button

After selecting the programme or drying time depress this button to start the appliance.

Should the door be opened while appliance is drying, the START button has to be depressed again after closing the door to allow the programme to continue.

This button must be depressed also after a power failure and after having re-inserted the water container, if it has been emptied during the drying programme.

7 "Drying" light

This light indicates that the machine is performing the drying programme.

8 "Cooling" light

This light will illuminate when the cooling phase is in operation.

A cooling phase of 9 minutes is performed at the end of the drying programme and before the anti-crease phase.

9 "End of programme" light

This light flashes at the end of the programme (after the cooling phase) and continues to flash during the anti-crease phase to remind you that filter needs cleaning and water container must be emptied. It goes out when you open the door or turn the programme selector dial to "0".

10 "Water container full" light

This light flashes when the water container is full and when drying is completed.

11 Programme selector dial

The selector dial allows you to select the desired programme or time.

Automatic drying (electronic programmes)

The appliance operates in these programmes by means of dampness sensors. All you have to do is to set the selector dial to the programme required (A, B, C or D), according to the type of laundry and the degree of drying required (see programme table).

Time controlled drying

You can select a time up to 90 mins. to finish off drying, if necessary, or to use your tumble dryer independently of the electronic control system.

When selecting a short drying time, remember that during the last 9 mins. of operation, the heat is cut off in order to carry out a cooling phase.

To cancel a programme in operation, turn the selector dial to "0".

When drying is completed, switch off the appliance by turning the dial to "0" before opening the door.

12 Mains-on light

This light lights up by selecting the programme or time and goes out by turning the selector dial to "0" or by opening the door.

Programme Table Automatic drying (electronic programmes)

Type of laundry	Degree of drying required	Max. load	Programme selector setting
Cotton	Extra dry	5 kg	A
	Store dry	5 kg	B (*)
	Iron dry	5 kg	C (*)
Synthetics	Store dry	2 kg	D (*)

(*) According to CEI 1121 Standards

Time controlled programmes

Cotton

Degree of drying required	Spin speed	Max. load	Drying time
Store dry	800 - 1000 r.p.m.	3.5 kg	75 - 90 min.
		2 kg	60 - 75 min.
	1000 - 1200 r.p.m.	3.5 kg	60 - 75 min.
		2 kg	45 - 60 min.
Iron dry	800 - 1000 r.p.m.	3.5 kg	60 - 75 min.
		2 kg	45 - 60 min.
	1000 - 1200 r.p.m.	3.5 kg	45 - 60 min.
		2 kg	30 - 45 min.

Synthetics: depress pushbutton

Degree of drying required	Spin speed	Max. load	Drying time
Store dry	Short spin at 650 rpm	2 kg	45 - 60 min.
		1 kg	30 - 45 min.
		0.5 kg	20 min.

Never overfill the drum (do not load large quilts, for example).

The laundry must be suitably spin dried in your washing machine before being placed in the tumble dryer (500rpm minimum).

Drying times vary according to:

- The type of laundry
- The size of the load
- The degree of spinning prior to drying

i Drying sequence

Before starting up for the first time it is advisable to load a few moist cloths into the dryer and to let it run for about 20 minutes. This ensures that no dust and dirt is left in the drum.

1. Load the laundry



Open the door by depressing button .

Load the items one at a time, shaking them out loosely and close the door.

2 Select drying programme or time

Turn the programme selector dial to the programme letter or time, the mains-on light illuminates.

3 Select the required option



Depress "low temperature" button  if you have to dry synthetics with a time controlled programme and/or "buzzer off" button  if desired.

4 Start the programme



Depress START-button : the drying programme begins and the control light  goes on.



Important: If you wish to change the programme during operation, turn the selector dial to "0", select the new programme and depress START-button again.

5 When drying is completed

Before the end of the cycle, an automatic cooling phase of 9 mins. is carried out to cool the laundry: the control light  is on. At the end of this phase lights  and  will begin to flash alternatively.

If you do not remove the laundry at the end of the programme, the machine will perform the anti-crease phase which lasts 30 mins. max.

If you have not depressed button , the buzzer will sound every 10 seconds, the lights  and  will flash alternatively. To remove the laundry at this stage, turn the selector dial to "0", the mains-on light goes out.

If you do not remove the laundry during the anti-crease phase, the appliance will stop automatically at the end of this phase: the mains-on light will remain lighted and the control lights  and  will continue to flash.

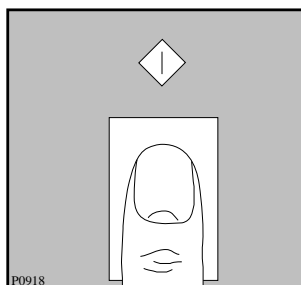
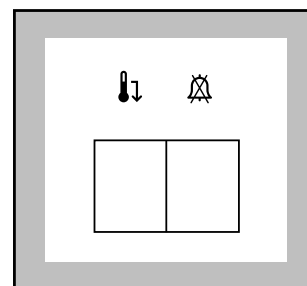
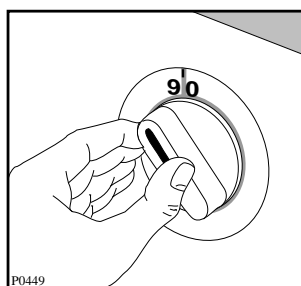

Clean the filter and empty water container.



Useful hints

- Try to load to the maximum capacity of the machine as small loads are uneconomical. For information, here is a list of the average weights of some common laundry items.

Sheet	700 - 1000 g
Tablecloth	400 - 500 g
Kitchen towel	70 - 120 g
Table napkin	50 - 100 g
Towelling hand towel	150 - 250 g
Bathrobe	1000 - 1500 g
Man's shirt	200 - 300 g
Pillowcase	100 - 200 g
Man's pyjamas	400 - 500 g
Ladies' nightdress	200 - 250 g

- Never tumble dry the following: Particularly delicate items such as net curtains, woollen, silk, fabrics with metal trim, nylon tights, bulky materials such as anoraks, blankets, eiderdowns, sleeping bags, feather quilts and any items containing rubber foam or materials similar to rubber foam.
- Always follow the instructions on garment labels.
 -  normal drying (high temperature)
 -  delicate drying (low temperature)
 -  do not tumble dry
- Close pillowcases and covers with fasteners to prevent small laundry items getting tangled inside them. Close press studs, zips and hooks and tie belts and apron strings.
- Sort laundry according to type and degree of drying required.
- Do not over-dry laundry, this avoids creasing and saves energy.
- Avoid drying dark clothes with light coloured fluffy items such as towels as they could attract the fluff.
- The laundry must be thoroughly spun before tumble drying.
- **Easy-care items**, too, e.g. shirts, should be briefly pre-spun before drying (depending on crease resistance approx. 30 seconds or using the special brief spin programme of your washing machine).

- Knitted textiles (knitted underwear) may shrink a little during drying. Please **do not** overdry items of this type. It is advisable to allow for shrinkage when choosing the size of new purchases.
- You can also put starched items into your dryer. However, to achieve the desired starched effect, choose the programme "iron dry". To remove any starch residues, wipe out the internal drum after drying with a moist cloth and then rub it dry.
- To avoid a static charge when drying is completed, use either a fabric softener when you are washing the laundry or a fabric conditioner specifically for tumble dryers.
- Remove the laundry when the dryer has finished drying.
- If individual items are still damp after drying, set a brief post-drying time, but **at least 20 minutes**. This will be necessary particularly for multilayered items (e.g. collars, pockets, etc.).

MAINTENANCE

You must **disconnect** the appliance from the electricity supply, before you can carry out any cleaning or maintenance work.

External cleaning

Use only soap and water and then dry thoroughly.

From time to time, apply a little wax furniture cream with a soft cloth.

Important: do not use methyated spirit, diluents or similar products.

Cleaning the filter

Your dryer will only function well if the filter is clean.

The filter collects all the «fluff» which accumulates during drying and it must therefore be cleaned at the end of each programme with a damp cloth.

Pull the filter upwards in order to remove it.

Do not be alarmed by the amount of fluff. It is not due to excessive wear caused by the dryer. All fabric loses fluff when drying but it goes unnoticed in the air. In a tumble dryer it simply collects in the filter.

Important: Remove the fluff around the filter too.

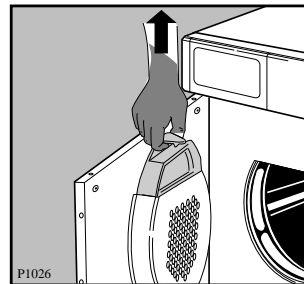

Cleaning condenser

Remove fluff from condenser on a regular basis to avoid prolonging drying times and increasing energy consumption.

Proceed as follows:

1. Remove condenser by using the top handle.
2. Clean condenser with a hand-held shower or a soft brush.
3. Clean external part, too.
4. Remove the fluff from the seal of the condenser in the lower part of the inner door.
5. Leave condenser to dry; when it is dry, place in original position.

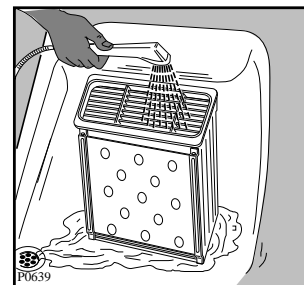
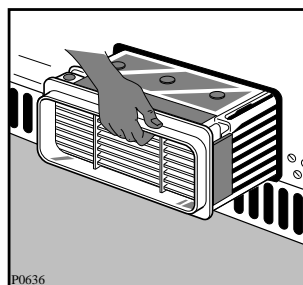

Important! Do not use pointed objects or utensils to clean the spaces between the plates, as this could damage the condenser and make it permeable.

Do not use this appliance if the condenser has not been fitted.

Emptying water container

Water extracted from the laundry being dried is collected in a special container. This container must be emptied after every cycle, but it can also be emptied during the drying cycle. Should you forget to empty the container, a light will light up on the panel and the drying cycle will stop automatically even if the laundry is not dry yet.

Insert container correctly.

After inserting the container the drying cycle will resume after 135 seconds max.

Important: When emptying the container during the drying cycle, the machine stops drying, but the drying time selector dial will continue to step on.

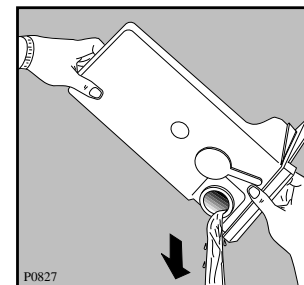
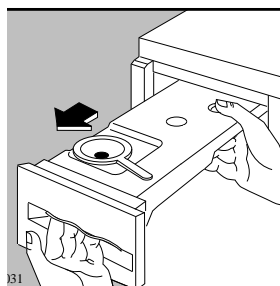

SERVICING

Before contacting your local Zanussi Service Centre, please make the following checks:

PROBLEM	POSSIBLE CAUSE
<ul style="list-style-type: none">■ The dryer does not start up	<ul style="list-style-type: none">■ The door is open.■ The plug is not fitted into the wall socket.■ There is no electricity supply from the wall socket.■ The selector dial is not set correctly.■ The water container is full.■ The start button has not been depressed.
<ul style="list-style-type: none">■ The dryer does not dry properly	<ul style="list-style-type: none">■ The filter is clogged.■ The water container is full.■ The condenser is clogged.■ Insufficient drying time.■ The selected cycle is not suitable for the laundry.■ The low temperature function has been selected in the electronic programme.■ Excessive laundry load.■ The dryer is not correctly installed.

If, after the above checks, there is still a fault, call your local Zanussi Service Centre.

Please make sure you give the model and serial number of the appliance.

This information can be found on the rating plate.

ANOMALIAS DE FUNCIONAMENTO

Antes de contactar o Centro de assistência Zanussi da zona, efectue os seguintes controlos:

PROBLEMA	CAUSA POSSIVEL
<ul style="list-style-type: none"> ■ Se o secador não funcionar: 	<ul style="list-style-type: none"> ■ A porta está aberta ■ A ficha não está inserida na tomada. ■ Não há corrente eléctrica ■ O selector de secagem não está posicionado correctamente. ■ O recipiente da água está cheio. ■ A tecla de arranque não foi premida.
<ul style="list-style-type: none"> ■ Se o secador não seca correctamente: 	<ul style="list-style-type: none"> ■ O filtro está entupido. ■ O recipiente da água está cheio. ■ O condensador está entupido. ■ O tempo de secagem é insuficiente. ■ Foi seleccionada a função de redução da temperatura no programa electrónico. ■ O ciclo seleccionado não é apropriado para a roupa. ■ O secador está sobrecarregado. ■ O secador não foi instalado correctamente.

Se depois destas comprovações o problema permanece, dirija-se ao Centro de Assistência Técnica ZANUSSI mais próximo.

Indique o modelo e o número de fabrico da máquina, que estão indicados na placa de características.

