

INSTRUCTION BOOKLET

INSTRUCTION BOOK DEPT.
LIBRARY
MASTER COPY

**READ AND KEEP
THESE INSTRUCTIONS**

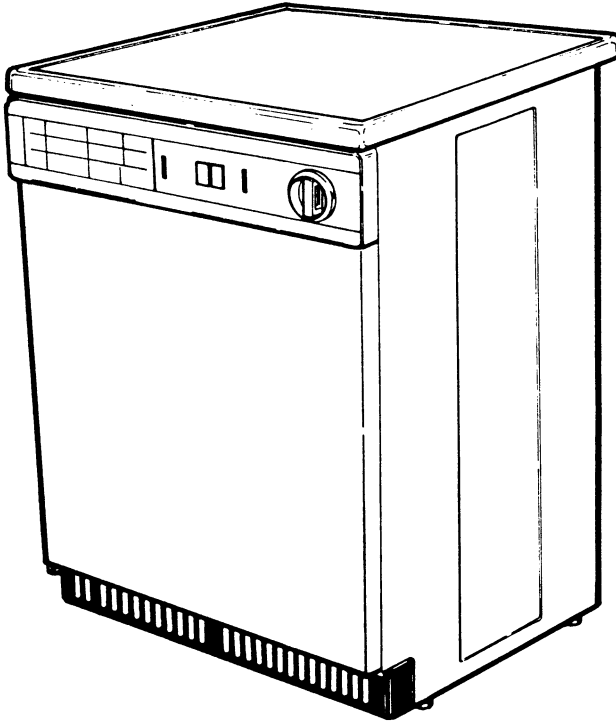

**TUMBLE DRYER
TC 450**

ZANUSSI

It is most important that this instruction book should be retained with the appliance for future reference. Should the appliance be sold or transferred to another owner, or should you move house and leave the appliance, always ensure that the book is supplied with the appliance in order that the new owner can get to know the functioning of the appliance and the relevant warnings.

Warnings and Guidance

These warnings are provided in the interest of safety, you must read them carefully before installing or using the appliance.

- Always switch off and unplug the appliance after use.
- Any electrical work required to install this appliance should be carried out by a qualified electrician.
- This machine is designed to be operated by adults. Children should not be allowed to tamper with the controls or play with the product.
- This product should be serviced by an authorised Zanussi Service Force Centre, and only genuine Zanussi spare parts should be used.
- It is dangerous to alter the specifications or modify this product in any way.
- Care must be taken to ensure that the appliance does not stand on the electrical supply cable.
- Do not overload the appliance.
- Never tumble dry items that have had contact with chemicals such as dry cleaning fluid. These are of a volatile nature and could cause an explosion.
- Fluff filters must be cleaned after every use.
- Do not operate the appliance with a damaged filter or with no filter at all, as this may cause a fire.
- Do not allow fluff to accumulate around the dryer.
- As some bulky items such as duvets and eiderdowns should be dried in large commercial machines because of their bulk, check with the manufacturer of the item if it is suitable for drying in a domestic machine, even if the dry weight of the item is within the limit advised.
- This appliance must be installed in a clean, dry environment. Cabinet damage, which is not covered by guarantee, could ensue if this recommendation is not adhered to.
- Pets and children have been known to climb into tumble dryers. Check your drum before use.
- Under no circumstances should you attempt to repair the machine yourself. Repairs carried out by inexperienced persons may cause injury or serious malfunctioning. Refer to your local Zanussi Service Force Centre. Always insist on genuine Zanussi spare parts.

CONTENTS

Specifications	Page 3
General Features	Page 4
Installation	Page 5
Electrical Connections	Page 7
Getting To Know Your Machine	Page 8
The Drying Times	Page 9
Using Your Machine	Page 10
Maintenance and Cleaning	Page 11
What Happens If Something Goes Wrong?	Page 13
Servicing	Page 13
Service Agent Directory	Page 14
Peace Of Mind For Twelve Months	Page 18
Or Five Years	Page 19

SPECIFICATIONS

TC450

Dimensions

With worktop

Height:	850mm
Width:	597mm
Depth:	600mm

The worktop is adjustable by 20mm.

Without worktop

Height:	820mm (without plastic web)
Width:	597mm
Depth:	570mm
Depth with open door:	1200mm

Wash Load:	4.5kg/10lbs
Nominal Voltage:	240v/50Hz
Drive Motor:	250W
Fan Motor:	100W
Heating Element:	2380W
Total Power Absorbed:	2730W

GENERAL FEATURES

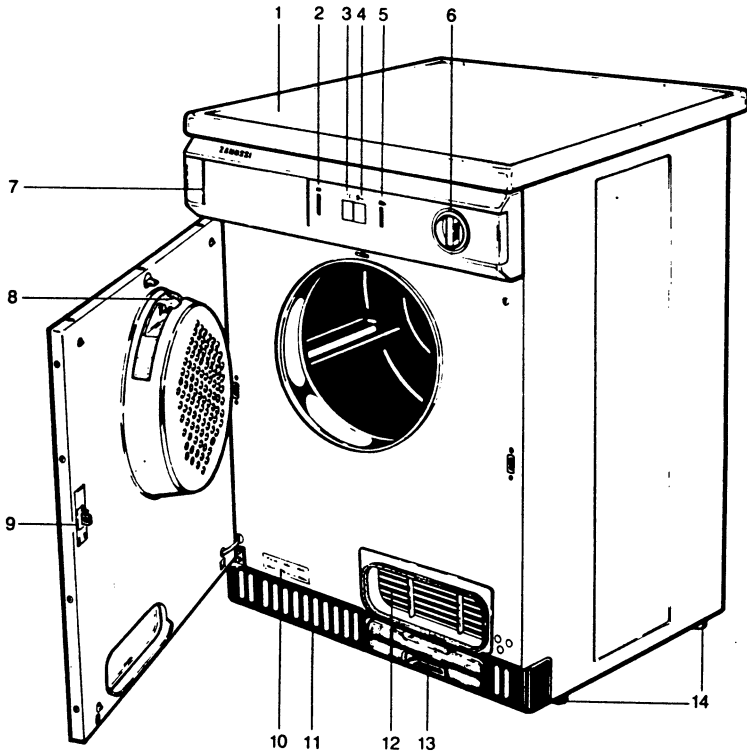

1. Worktop
2. Mains On Light
3. Low Temperature Button
4. Door Release Button
5. Water Reservoir Indicator Lamp
6. On/Off Dial - Time Selector Dial
7. Programme Chart
8. Fluff Filter
9. Door Catch
10. Rating Plate
11. Ventilator Grille
12. Air Condenser
13. Water Reservoir Container
14. Height-adjustable feet

INSTALLATION

This tumble dryer can be positioned without the need for any special type of installation as the operation of the condenser unit means that there is no steam to vent. You will, however, need to ensure that there is a continuous air supply and the hot air which is discharged through the venting slots at the base of the machine must not be restricted.

It is recommended that, for your convenience, the machine is positioned close to your washing machine.

To keep vibration and noise to a minimum when the dryer is in use, it should be placed on a firm, level surface. Once in its permanent operating position, check that the dryer is absolutely level, with the aid of a spirit level. If it is not, raise or lower the two adjustable feet at the front of the machine until it is. The machine should not stand on a long-pile carpet or be enclosed around the base as this will lead to a build-up of heat which could damage the motor.

IMPORTANT

The hot air discharged from the tumble dryer may reach a temperature of 60°C. Check that the floor covering can withstand this degree of heat.

The room temperature should not exceed +35°C during operation, ventilate the room if it exceeds this.

The space around the tumble dryer must be kept free of fluff.

Door Assembly Instructions

The machine has a furniture door which can be hinged on the left hand or right hand side. The machine is supplied with the door hinged on the left hand side.

To change the door hinging from left hand side to the right, the hinge fastening plate needs to be fitted to the right hand side of the machine, in place of the plastic plugs. The plastic plugs then need to be refitted where the plate was previously located, see Fig. 1.

1. Unhook door stopper 'A' from door mounting 'a' and loosen from hole 'b' by a 90° rotation.

2. Remove the plastic plug from hole 'c' by a 90° rotation and re-fix in hole 'b'.

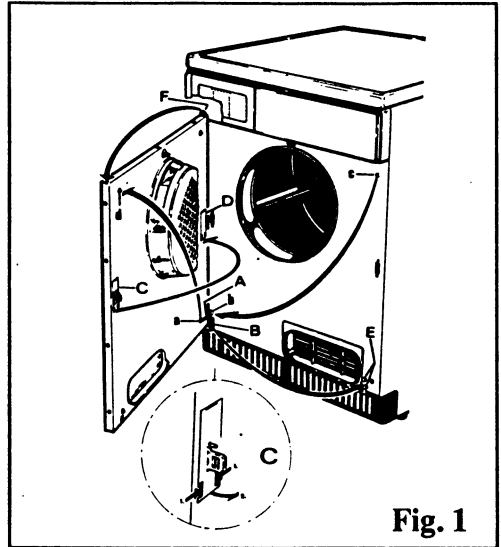

Fig. 1

3. Unscrew hinge 'B' (loosen the 2 screws, holding the door securely) and lower the door from the top pivot.

4. Re-insert pin 'F' from the door above and below on opposite side respectively.

5. Loosen door catch 'C' by pressing together both lugs (see small illustration).

6. Loosen opposite plastic part 'D' as under point 5 (you may possibly need to use a tool to assist in both steps 5 and 6 - eg. screwdriver).

7. Interchange and insert parts 'C' and 'D'.

8. Remove screws 'E'.

9. To mount door, see Fig. 2:

* First locate into upper right hand hole with upper pin.

* Then place lower pin into hinge and locate the hinge on to the bottom of the door. Secure the hinge in position with screws 'E'.

* Align door before tightening hinge.

* Tighten hinge.

10. Fix door stopper 'A' in hole 'C' by 90° rotation.

11. Remove plug from hole 'd' and hook door stopper into the hole. Ensure you have the hook the correct way round to catch the door as it opens.

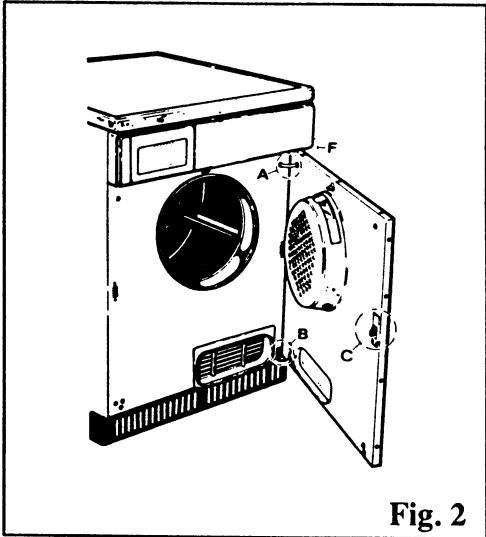

Fig. 2

Instructions For Building In Under A Counter

The appliance can be integrated in fitted kitchens or installed as a build-under unit after removal of the worktop. Proceed as follows:

* Unplug the appliance.

* Unscrew the mounting screws at the rear of the appliance (Fig. 3).

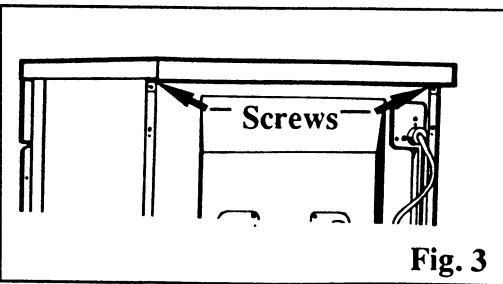

Fig. 3

* Pull the worktop back and lift it to remove.

If the worktop is removed for building in with other kitchen furniture, the installation must be carried out so that electrical and mechanical parts are not accessible.

A protective cover to ensure the safety of the machine must be fitted, and can be purchased from your local Zanussi service centre.

When you fit the protection cover, stick or fix foam sealing strips around the edge of the top to prevent any water seeping inside the cabinet.

The main electricity supply switch must be easily accessible.

Connecting a drainage hose

If a drainage facility is available where the machine is installed, the condensation can be directly discharged via a drainage hose, see Fig. 4. (Which can be obtained from your local Zanussi Service Force Centre).

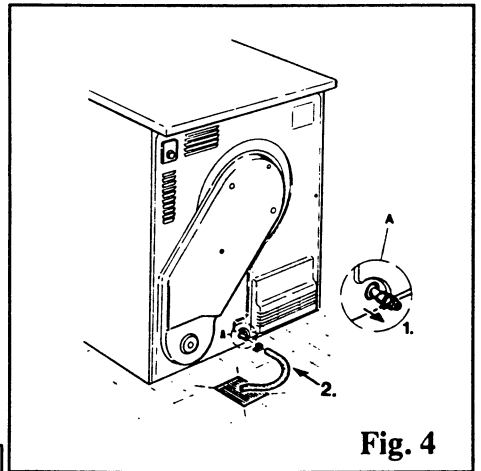

Fig. 4

THE ELECTRICAL CONNECTIONS

WARNING THIS APPLIANCE MUST BE EARTHED.

The manufacturer declines any liability should this safety measure not be observed.

If the plug that is fitted to your appliance is not suitable for your socket outlet, it must be cut off and the appropriate plug fitted.

The cut off plug should be disposed of to prevent the hazard of electric shocks in case it should be plugged into a 13amp socket in another part of your home.

Important

The wires in this mains lead are coloured in accordance with the following code:

Green and Yellow	- Earth
Blue	- Neutral
Brown	- Live

If you fit your own plug, the colours of the wires in the mains lead of your appliance may not correspond with the markings identifying the terminals in your plug, proceed as follows:

Connect the green and yellow (earth) wire to the terminal in the plug which is marked with the letter 'E' or the earth symbol or coloured green, or green and yellow.

Connect the blue (neutral) wire to the terminal in the plug which is marked with the letter 'N' or coloured black.

Connect the brown (live) wire to the terminal which is marked with the letter 'L' or coloured red.

The plug moulded onto the cord incorporates a fuse. For replacement, use a 13amp BS1362 fuse. Only ASTA approved fuses should be used.

The fuse cover/carrier must be replaced in the event of changing a fuse. The right fuse cover/carrier is the one shown by the coloured insert at the base of the plug.

The plug must not be used if the fuse cover/carrier is lost. A replacement cover/carrier must be obtained from Zanussi Service Force Agents whose addresses are listed on pages toward the back of this instruction book.

This appliance complies with E.E.C. directive no. 82/499 of 7.6.82 relative to radio interference suppression.

In addition, avoid connecting the dryer to the same socket as your washing machine (or any other appliance) by means of an adaptor. Have an extra socket installed if necessary by a qualified electrician.

GETTING TO KNOW YOUR MACHINE

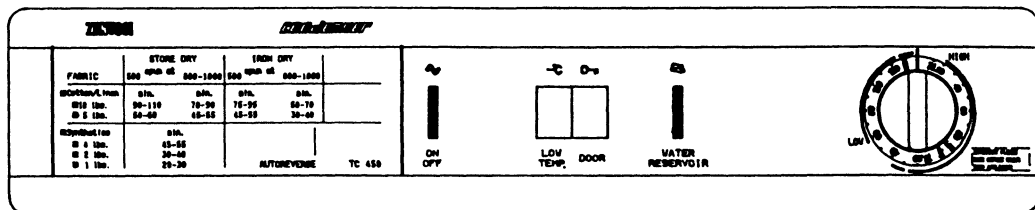

Fig. 5

The Controls And How To Use Them (Fig. 5)

1. Mains On Light
2. Low Temperature Button
3. Door Release Button
4. Water Reservoir Indicator Light
5. On/Off dial - Time Selector Dial

1. Mains On Light

The pilot light indicates operating status.

2. Low Temperature Button

This switch can be used when the machine is in the process of a high temperature programme. It will reduce the heat to a cooler temperature and will gently dry the clothes. Your tumble dryer continues to operate with reduced heating.

3. Door Release Button

You press this button when you wish to open the door.

4. Water Reservoir Indicator Light

The indicator lamp will show that the water container is full or improperly fitted. The programme will be interrupted.

5. On/Off Dial - Time Selector Dial

Turn the dial clockwise (to the right) to select the time, programme and time for drying (see Chart page. 9). At the same time the machine is switched on and the programme starts.

THE DRYING PROGRAMMES

Time Controlled Programmes

The programme guide is designed to help you. This dryer has two drying times of up to 120 and 80 minutes, giving a high or low heat temperature according to the fabric type. This can be extended when the original programme is completed, by re-setting the control knob for a further period of drying.

The door of the machine can be opened at any time during the programme if you want to feel the dryness of the fabrics. Do not over-dry the fabric, as it gives it a rough feel, also it will be difficult to iron.

Remember that during the last 10 minutes of the operation, the heat is cut off in order to carry out a fabric cooling phase, which minimises creasing or crumpling of the fabrics.

THE DRYING TIMES

Type of Laundry	Degree of drying Required	Degree of spin-drying given to laundry	Quantity	Control Knob Setting
Cotton and Linen <input type="checkbox"/>	Store Dry	500 rpm	10lbs 5lbs	80-100 min. 50-60 min.
		800 - 1000 rpm	10lbs 5lbs	65-85 min. 45-85 min.
High Temp. <input type="checkbox"/>	Iron Dry	500 rpm	10lbs 5lbs	65-85 min. 45-55 min.
		800 - 1000 rpm	10lbs 5lbs	45-65 min. 30-40 min.
Delicate and Synthetic Fabrics <input type="checkbox"/> Low Temp.	Store Dry	500 - 1000 rpm	4lbs 2lbs 1lb	45-55 min. 30-35 min. 20-25 min.

USING YOUR MACHINE

Sorting The Load

The maximum load you can dry in your tumble dryer is 4.5kg (10lb) of cotton, linen and other strong fabrics, 1.75kg (4lb) of synthetics and 2.25kg (5lb) of absorbent fabrics such as towelling.

If you are using a washing machine, all you have to do is transfer the clothes, after the spin cycle from the washing machine to the tumble dryer. Sort the laundry according to fabric. If the items are very wet, they will take a very long time to dry and so it is preferable to spin dry any item before putting it into the tumble dryer.

Loading The Laundry

Open the door by pressing button 3.

If you are using your tumble dryer for the first time, it is recommended that you place a few damp cloths into the drum and allow it to run for around 15 minutes. This will ensure that no dirt or dust remains in the drum.

Load the clothes, alternating large items such as sheets and tablecloths with smaller items like shirts, hand towels etc. Make sure that all pockets are empty of coins etc, zips are closed and belts etc tied. Quilt covers and pillow-cases should be buttoned up so that any small objects cannot collect inside them. Close the door firmly until it clicks.

The following fabrics should not be loaded in the dryer:

Clothes which have been dry cleaned with chemical solvents.

Woolens or woollen mixtures loosely knitted and likely to shrink with heat.

Rubber-like materials.

Delicate fabrics like pure silk, and synthetic curtains or fibre glass items and sponge rubber items.

Only laundry washed in water should be dried with the tumble dryer.

To start the machine

Check that:

The mains switch is on.

The door is properly closed.

Select the programme by turning the time selector dial clockwise to the required time and programme options (high or low heat, see Chart page. 9).

The operating pilot light will then come on and the machine will start. The machine will automatically carry out the chosen drying cycle or complete the chosen time. The machine turns off automatically and the pilot light will go out.

Open the door and take out the dried items, then clean the fluff filter (for instructions on how to clean the fluff filter see page 11). Empty the water from the water reservoir container, see page 11.

General Hints

Laundry Shrinkage

Certain fabrics such as woollens and silks are generally not suitable for tumble drying. Due to the structure of some woollen garments which are recommended for tumble drying shrinking could still occur, but once the garment is worn again it should regain its shape.

Starched Laundry

Starched laundry can also be dried in the tumble dryer. Make sure that the time selected is for iron dry. After completion of the programme wipe out the drum with a damp cloth and dry to remove any traces of starch.

*WARNING

As some bulky items such as duvets and eiderdowns should be dried in large commercial machines because of their bulk, check with the manufacturer of the item if it is suitable for drying in a domestic machine, even if the dry weight of the item is within the limit advised.

MAINTENANCE AND CLEANING

IMPORTANT

Make sure that the machine is unplugged before undertaking any kind of maintenance.

Cleaning The Fluff Filter

The fluff filter should be cleaned after every drying process. A considerable amount of fluff accumulates but this is not due to extra wear caused by the drying process. During drying on a washing line fluff attached to the surface of the clothes is blown away by the wind and is therefore not noticeable, see Fig. 6.

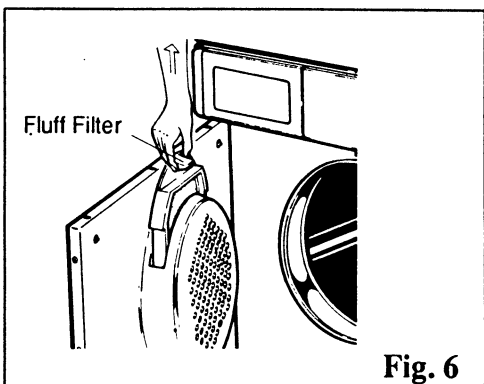

Fig. 6

Emptying The Water Reservoir Container

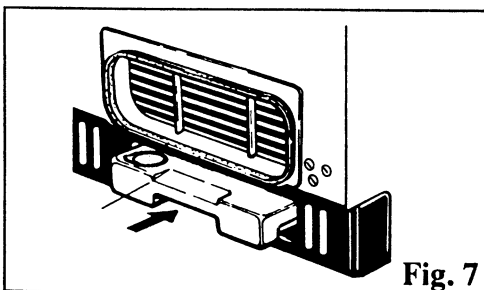

Fig. 7

The water extracted from the laundry is condensed in the dryer and collected in the water reservoir container, see Fig. 7.

The water reservoir container must be emptied after every drying process, if you forget to empty this the warning indicator lamp will light up and the programme will be interrupted.

To empty, grasp the trough from underneath and slowly remove the container. Empty the contents and push back in. (see Fig. 8)

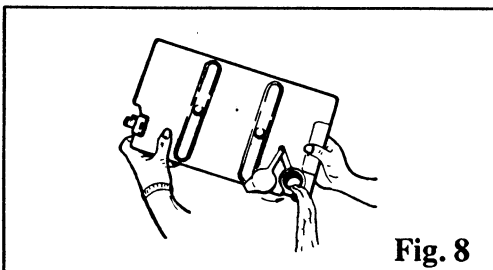

Fig. 8

The collected water can be used for steam ironing. To do this, you must put the condensed water through a filter e.g. Coffee filter.

Cleaning The Dryer Housing

Clean the control panel, the dryer housing and the drum with soapy water or with mild household detergent.

Should a coating appear on the drum after a prolonged period of use, this can be wiped away with a little vinegar.

Cleaning The Air Condenser

You will need to do this from time to time. If you use your dryer very frequently, approximately 3-4 times per year.

Pull out the box on upper handle recess and clean free of fluff (see Fig. 9).

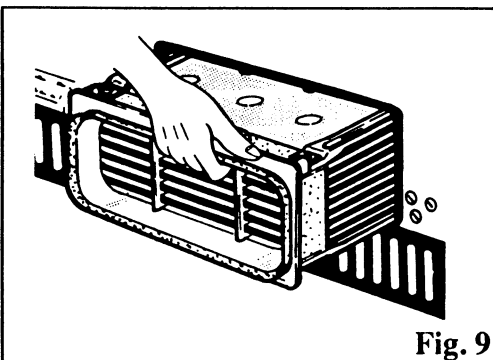
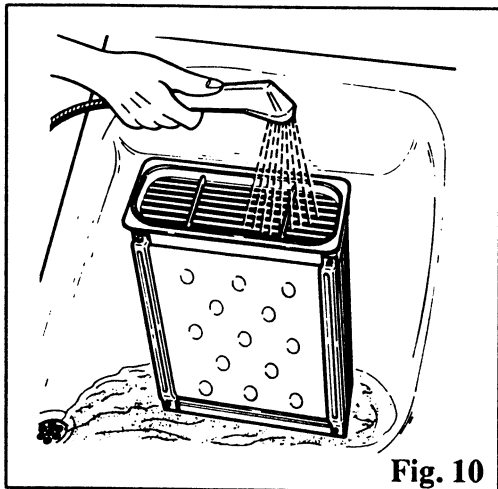

Fig. 9

Wipe the outside of the condenser and remove any fluff.

Clean the condenser with a brush or a hand shower attachment (Fig 10).



Clean the rubber seals of door opening and air condenser with a damp cloth immediately after every drying operation.

WHAT HAPPENS IF SOMETHING GOES WRONG?

If the machine is not working...

Is the machine properly plugged in?

Is the fuse okay?

Is the door closed properly?

Is the programme properly set?

Is the Water Reservoir Container empty or properly inserted? (if NOT, the 'Water Reservoir' indicator lamp lights up).

The machine does not dry satisfactorily...

Has the correct time been set?

Has the gentle programme been selected for drying, although full heating should be used for drying?

Has the Water Reservoir container been emptied? (if the container is full, the programme will be interrupted during operation).

Has the fluff filter been cleaned? (if NOT the programme overruns; on the time programme, the set time is insufficient).

IN-GUARANTEE CUSTOMERS SHOULD ENSURE THAT THE ABOVE CHECKS HAVE BEEN MADE AS THE ENGINEER WILL MAKE A CHARGE IF THE FAULT IS NOT A MECHANICAL OR ELECTRICAL BREAKDOWN.

*** Please note that proof of purchase is required for any in-guarantee service calls.**

If, after making these checks the tumble dryer is still not working, you will need to contact your local Zanussi Service Force Centre, whose address and telephone number can be found on the following pages.

SERVICING

How To find the telephone number of your Zanussi Service Force

Zanussi Service areas are allocated by postcodes which are listed in alphabetical order for easy reference.

1. Look for the first two letters of your address postcode in the far left 'Postcode' column.
2. Match up the number of your postcode against the number listed in the 'Postcode Numbers' column.
3. Look across the column to the Service Force Key Number for your area. Turn to the last page of this directory for the address and telephone number to contact for service which is listed against your key number.

If you are unsure of your postcode, the main towns and cities are listed in alphabetical order for easy reference.

Additionally, your local Zanussi Service Force Centre telephone number is listed under 'Z' in your telephone directory.

The Customer Care Department at Zanussi House, Hambridge Road, Newbury, Berks, RG14 5EP, Tel: 0635 521313, will be happy to help you with any queries or difficulties.

Post-code Letter	Town	Post-code Number	Service Force Key Number	Post-code Letter	Town	Post-code Number	Service Force Key Number
AB	Aberdeen	1-5	1	DG	Dumfries	1-7, 10-12	34
AL	St Albans	1-10	2	DG		13-14	35
A	Brecon	45	3	DG		8-9	36
BA	Bath	1-5, 11-15	4	DH	Durham	1-9	37
BA		7-10, 20-22	5	DL	Darlington	1-17	37
BA		6, 16	6	DN	Doncaster	1-7, 10-12, 22	33
BB	Blackburn	1-12	7	DN		14	38
BD	Bradford	1-23	8	DN	Doncaster	8-9, 15-21, 31-40	39
BD		24	7				
BH	Bournemouth	1-18, 21-25	9	SUB POSTCODE DIVISION			
BH		19-20	10	DN	Gainsborough		
BL	Bury	0-9	11		South	21-1, 21-2, 21-5	40
BN	Brighton	1-9, 11-15,	12	DN	Gainsborough		
BN		20-27	12		North	21-3, 21-4	39
BN		16-18	13				
BR	Bromley	1-8	14	DT	Dorchester	1-6, 10-11	10
BS	Bristol	1-28, 98-99	15	DT		6-9	5
BT	Belfast	1-82	16				
B	Birmingham	1-21, 25-33,	17	SUB POSTCODE DIVISION			
B		38, 40, 45, 47-	17	DT	Bridport East	6-3, 6-4	10
B		48, 62-71	17	DT	Bridport West	6-5, 6-6	5
B	Birmingham	23-24, 34-37,	18				
B		42-44, 46, 72-	18	DY	Dudley	1-6, 8-9	17
B		79	18	DY		7, 10-14	41
B	Birmingham	49-50, 60-61,	19	EC	London	All EC Codes	28
B		80, 96-98	19	EH	Edinburgh	1-42, 52-54	42
B	Birmingham	95	20	EH		43-46	35
CA	Carlisle	1-16, 18-28	21	EH	Edinburgh	47-49, 51, 55	43
CA		17	7	EN	Enfield	1-11	28
CB	Cambridge	1-8	22	EX	Exeter	1-17, 20	45
CB		9-11	23	EX		18-23, 31-39	46
CF	Cardiff	1-8, 31-48	3	E	London	All East Codes	28
CH	Chester	1-4	24	FK	Falkirk	1-4	43
CH		5-7	25	FK		10-14, 18-19	32
CH		8	26	FK	Falkirk	5-9, 15-17	47
CM	Chelmsford	0-6, 8-9, 11-15	27	FK		20-21	31
CM		7	23	FY	Fleetwood	0-8	7
CM	Chelmsford	16-24	28	GCI	Guernsey		48
CO	Colchester	1-16	23	GL	Gloucester	1-8, 10-19,	49
CR	Croyden	0, 2-4, 9	29	GL		50-56	49
CT	Canterbury	1-21	14	GL		9	15
CV	Coventry	1-13, 21-23, 31-	20	GL		20	19
CV		35, 37	20	GU	Guildford	1-24, 26, 34-35	50
CV		36	19	GU		25	51
CW	Crewe	1-12	30	GU	Guildford	27-33	13
DA	Dartford	1-18	14	G	Glasgow	1-5, 11-15, 20-23,	47
DD	Dundee	1-5, 7-11	31	G		31-34, 40-46, 51-	47
DD		6	32	G	Glasgow	53, 58, 60-69, 73,	47
DE	Derby	1-7, 13-15, 55	33	G		76-78, 81-84	47
DE		11-12	20	G	Glasgow	71-72, 74-75	43
				HA	Harrow	0-9	52

Post-code Letter	Town	Postcode Number	Service Force Key Number	Post-code Letter	Town	Postcode Number	Service Force Key Number
HD	Huddersfield	1-8	8	ME	Medway	1-20, 99	14
HG	Harrogate	1-5	8	MK	Milton Keynes	1-17, 19, 40-46	22
HP	Hemel	1-3	2	MK		18	65
HP	Hempstead	4-23	53	ML	Motherwell	1-12	43
HR	Hereford	1-2, 4, 6-9	49	M	Manchester	1-35, 60	11
HR		3, 5	54	NE	Newcastle-on-Tyne	1-49, 61-70, 88	66
HU	Hull	1-20, 55	38	NE		98-99	66
HX	Halifax	1-7	8	NE		71	35
IG	Ilford	1-11	28	NE			
IOM	Isle of Man		55	NG	Nottingham	1-23, 25	33
IP	Ipswich	1-15, 30-31	56	NG		24	40
IP		16-27	57	NG	Nottingham	31-34	64
IP	Ipswich	28-29, 32-33	22	NN	Northampton	1-7, 11-12	67
IV	Invermess	1-24, 26, 30-36,	58	NN		8-10, 14-18	22
IV		40-49, 51-56	58	NN	Northampton	13	65
IV	Invermess	25, 27-28	59	NP	Newport	1-9, 44	3
JCI	Jersey		60	NR	Norwich	1-35	57
KA	Kilmarnock	1-26, 28-30	43	NW	London	All NW Codes	52
KA		27	61	N	London	All N Codes	28
KT	Kingston-on-Thames	1-23	51	OL	Oldham	1-12, 15-16	11
KT		24	50	OL		13-14	7
KW	Wick	1-14	59	OX	Oxford	1-17	65
KW		15-17	62	PA	Paisley	1-4	47
KY	Kirkcaldy	1-16	32	PA		5-19	43
LA	Lancaster	1-23	7	PA	Paisley	20-27, 33, 35, 40-49	68
LD	Llandrindod	1-8	54	PA		28-31	69
LD		3	3	PA	Paisley	32, 34, 36-39, 61	70
LE	Leicester	1-5, 7-8, 11-14,	63	PA		62-78	68
LE		16-17	63	PA	Paisley	80-82, 88	71
LE	Leicester	6, 9-10	20	PA		83-87	72
LE		15	64	PE	Peterborough	1-15, 34, 38	64
LL	Llandudno	11-15	25	PE		16-19	22
LL		16-19	26	PE	Peterborough	20-25	40
LL	Llandudno	20-21, 23, 27, 31-	25	PE		30-33, 35-37	57
LL		32, 34-40, 42-47	25	PH	Perth	1-2, 8-9, 10-18	31
LL	Llandudno	22, 24-26, 28-30,	26	PH		3-7	32
LL		33-34, 41, 48-49,	26	PH	Perth	19-26, 30-44	58
LL		51-78	26	PL	Plymouth	1-21	73
LN	Lincoln	1-6, 8-10	40	PL		22-35	74
LN		7, 11-13	39	PO	Portsmouth	1-22	13
SUB POSTCODE DIVISION				PO		30-41	75
LN	Lincoln	3-4, 3-5	40	PR	Preston	1-9	7
LN		3-6	39	RG	Reading	1-17, 26	53
				RG		21-25, 27	50
				RG	Reading	28	4
LS	Leeds	1-29	8	RH	Redhill	1-3, 6-7, 9-20	12
LU	Luton	1-6	2	RH		4-5	50
LU		7	22	RH	Redhill	8	29
L	Liverpool	1-49, 60-70	24	RM	Romford	1-5, 7, 10-18	27

Post-code Letter	Town	Postcode Number	Service Force Key Number	Post-code Letter	Town	Postcode Number	Service Force Key Number
RM	Romford	6, 8-9	28	TS	Stockton-on-		
SA	Swansea	1-20, 31-32	3		Tees	1-29	37
SA		33-39, 41-44, 61-73	76	TW	Twickenham	1-20	51
SA	Swansea	40, 45-48	77	UB	Uxbridge	1-10	52
SE	London	All SE Codes	29	WA	Warrington	1-5, 8-9, 10-15	11
SG	Stevenage	1-9, 11, 15	2	WA		6-7	24
SG		10, 12-14	28	WA	Warrington	16	30
SG	Stevenage	16-19	22	WC	London	All WC Codes	52
SK	Stockport	1-3, 6-12	30	WD	Watford	1-2, 4-7	2
SK		4-5, 13 16	11	WD		3	53
SK	Stockport	17	33	WF	Wakefield	1-17	8
SL	Slough	1-10	53	WN	Wigan	1-5, 7	11
SM	Sutton	1-3, 7	51	WN		6, 8	24
SM		4-6	29	WR	Worcester	1-14	19
SN	Swindon	1-8, 11-16	65	WR		15	41
SN		9-10	4	WS	Walsall	1-15	18
SO	Southampton	1, 4, 41-43, 51	9	WV	Wolverhampton	1-4, 10-14	18
SO		2-3, 5, 21-24, 52	13	WV		5-9, 15-16	41
SO	Southampton	20	4	W	London	All West Codes	52
SP	Salisbury	1-5, 9-11	4	YO	York	1-3, 5, 7-8	8
SP		6	9	YO		4, 6, 11-18, 25	38
SP	Salisbury	7-8	10	YO	York	21-22	37
SR	Sunderland	1-7, 9	66	ZE	Lerwick	1,3	79
SR		8	37	ZE		2	80
SS	Southend-on-						
	Sea	0-9, 11-17, 99	27				
ST	Stoke-on-						
	Trent	1-18, 20-21	30				
ST		19	18				
SW	London	All SW Codes	52				
		Except 2, 9, 16					
SW	London	2, 9, 16	29				
SY	Shrewsbury	1-6, 9-17, 18-22	25				
SY		7, 17-19	54				
SY	Shrewsbury	8	41				
SY		23-25	77				
S	Sheffield	1-19, 30-31, 40-45,	33				
S		60-66, 74, 80-81	33				
S	Sheffield	70-73, 75	8				
TA	Taunton	1-11, 21-24	6				
TA		12-20	5				
TD	Selkirk	1-15	35				
TF	Telford	1-8, 10-13	41				
TF		9	30				
TN	Tonbridge	1-2, 4, 8-18, 23-30	14				
TN		3, 5-7, 19-22, 31-40	12				
TQ	Torquay	1-6, 9, 12-13	78				
TQ		7-8	73				
TQ		14	45				
TR	Truro	1-27	74				

Service Force Key Number	Service Force Address	Telephone Number	Service Force Key Number	Service Force Address	Telephone Number
1	60 Commerce Street, Aberdeen, AB2 1BP	0224 583949	41	1 Underhill Street, Bridgnorth, Salop, WV16 4BB	0746 7633
	or Tel:	0224 582704	42	38 Buccleuch Street, Dalkeith, Midlothian, EH22	031 663 77
2	Unit 4, Riverside Est, Coldharbour Ln, Harpenden	05827 461909	43	Block 2 Unit 5, Auchenraith Ind. Est. Rosendale Way, Blantyre	0698 8281
3	3 Pentwyn Road, Blackwood, Gwent, Sth Wales	0495 223151	45	91 Exeter Road, Exmouth, Devon, EX8 1QD	0395 2635
4	31 St Andrews Road, Benerton, Salisbury, SP2	0722 336072	46	3 Bear St, Barnstaple, North Devon, EX32	0271 7177
5	31 East Street, Crewkerne, Somerset, TA18	0460 72740	47	Unit E6C Annieland Ind. Est. Netherton Rd, Glasgow, Scotland	041 954 55
6	80 Killigrew Street, Falmouth, Cornwall, TR11	0984 31858		or Tel:	041 954 55
7	333 Rangleit Road, Walton Summit, Preston, PR5	0772 321200	48	Blencathra, Saumarez Lane, Castel, Guernsey	0481 5685
8	7 Crown Street, Leeds, Yorks, LS2	0532 460992	49	134 Eastgate Street, Gloucester, GL1 1QT	0452 4224
9	63 Curzon Road, Bournemouth, BH1 4PW	0202 303363	50	Unit 1 Redfields Ind. Pk, Church Crookham, Fleet	0252 8514
10	Poundbury Road, Dorchester, Dorset, DT1 2PJ	0305 264951	51	127 Walton Road, Molesey, Surrey, KT8 0DT	01 979 636
11	Unit 41/42 Clarendon Ct, Winwick Quay, W'ton	0925 50822		or Tel:	01 979 796
12	Sydney House, Queens Road, Haywards Heath	0444 417656	52	27 Christchurch Ind. Est. Forward Drive, Harrow	01 427 424
13	266 Main Road, Southbourne, Emsworth, PO10	0243 374814	53	Reform Road, Maidenhead, Berkshire	0628 7837
	or Tel:	0243 371170	54	Merion House, High Street, Llandrindod Wells	0597 4842
14	Bridgewood Hse, 8 Laker Road, Rochester, ME1	0634 201441	55	Tromode Wks, Cronkbourne Vill, Douglas, I.O.M.	0624 7606
	or Tel:	0689 61444	56	Unit 2b, Elton Park Business Centre, Hadleigh Rd, Ipswich, IP2 0DQ	0473 2117
15	89 Stoke Croft Road, Bristol, Avon, BS1 3RD	0272 246271	57	75 Grove Road, Norwich, NR1 3RL	0603 6296
	or Tel:	0272 246378	58	Unit 3B3, Smithton Ind. Est. Smithton, Inverness	0463 7918
16	Owenmore Hse, Kilwee Ind. Est., Upper Dunmurry Lane, Belfast	0232 301121	59	Main Street, Golspie, Sutherland, KW10 6RA	040 83351
17	66 Birch Rd East, Wyreley Rd Ind. Est, B'ham	021 327 1671	60	P.O.Box 45, Queens Road, St Helier, Jersey	0534 6700
18	Unit 3 Sterling Park, Claymore, Tamworth	0827 289800	61	Bruach, Blackwaterfoot, Isle of Arran	077 086 24
	or Tel:	0827 289822	62	Hatson Ind. Estate, Kirkwall, Orkney	0856 5457
19	7a Lower Leys, Evesham, Worcester, WR11	0386 443489	63	30a Scotland Road, Market Harborough, LE16	0858 3322
20	Unit 3, Bryant Road, Exhall, Coventry	0203 644277	64	Pinfold Rd, Manning Rd Ind. Est. Bourne, Lincs	0778 42214
21	High Ehenside, Egremont, Cumbria, CA22	0946 820509	65	Unit E19, Telford Rd, Launton Ind. Est. Bicester	0869 2485
22	1 Wharf Road, Higham Ferrers, Northants	0933 317727	66	Unit C1, Bergen Cl, Tyne Tunnel Trad. Estate, North Shields, Tyne & Wear	091 296016
23	Unit 18, Fourth Ave, Bluebridge Ind. Est, Halstead, Essex	0787 473982	67	53 Sandringham Road, Northampton, NN1 5NA	0604 37061
24	Unit 14, Dock Road, Birkenhead, L41 1JJ	051 639 1287	68	96 Argyll Street, Dunoon, Argyll, PA23 7NE	0369 2147
25	Plas Fynnon W/ouse, Middleton Rd, Oswestry	0691 652917	69	43 Crosshill Avenue, Cameltown, Argyll	0586 52006
26	Easy Launderette, Panton Hall, Denbigh, Clwyd	074 571 3272	70	Strathblayne, Miller Road, Oban	0631 6269C
27	19 Sirdar Rd, Off Brook Rd, Rayleigh, Essex	0268 741171	71	2 Kilweivagh, Gregory, Benbecula, Outer Hebrides	0870 2331
28	284 Alma Road, Enfield, EN3	01 805 6825	72	Churchouse, 16 James St, Stornaway, Isle of Lewis	0851 5555
29	194 Court Road, Eltham, London, SE9 4EN	01 859 3939	73	6 Embankment Ln, Embankment Rd, Plymouth	0752 22254
30	Unit 8b, Alderflat Dr, Newstead Ind. Est. Stoke-on-Trent, ST4 8HX	0782 643814	74	80 Killigrew Street, Falmouth, Cornwall, TR11	0326 31460
31	3-7 Blackness Street, Dundee, Scotland, DD1	0382 642828	75	109-111 Hunnyhill, Newport, Isle of Wight	0983 52306
	or Tel:	0382 455862	76	Roch, Haverfordwest, Dyfed	0437 71036
	or Tel:	0382 826809	77	4 Market Street, Aberaeron, W. Wales, SA46	0545 57025
32	33a Burnside, Auchtermuchty, Fife, Scotland	0337 28807	78	278 Torquay Road, Preston, Paignton	0803 52996
33	Unit 63, Storfonth Ln Trad. Est. Chesterfield	0246 231790	79	3-4 Carlton Place, Lerwick, Shetland, ZE1	0595 2915
34	93 Irish Street, Dumfries, Scotland	0387 69694	80	Harlsdale, Symbister, Whalassay, Shetland	08066 546
35	2-8 Wood Market, Kelso, Borders, TD5 7AX	0573 24411			
36	27 Antrim Ave, Stranraer, Dumfries & Galloway	0776 3277			
37	8 Cumbie Way, Aycliffe Ind. Est. Newton Aycliffe	0325 300606			
38	Unit 1, Boulevard Unit Fact. Est. Hull, HU3 4AY	0482 223335			
39	Unit 2, Cromwell Road, Grimsby, DN31 2BN	0472 358760			
40	Unit 14 Stonefield Park, Clifton Street, Lincoln	0522 532330			

PEACE OF MIND FOR TWELVE MONTHS

Zanussi Standard Guarantee Conditions

This guarantee is in addition to your statutory and other legal rights which will not be excluded or in any way diminished by the return of this guarantee card.

We, Zanussi Ltd, undertake that if, within twelve months of the date of the purchase, the ZANUSSI appliance or any part thereof is proved to be defective by reason only of faulty workmanship or materials, we will, at our option, repair or replace the same **FREE OF ANY CHARGE** for labour, materials or carriage on condition that:

- * The appliance has been correctly installed and used only on the electricity supply stated on the rating plate.
- * The appliance has been used for normal domestic purposes only, and in accordance with the manufacturer's operating and maintenance instructions.
- * The appliance has not been serviced, maintained, repaired, taken apart or tampered with by any person not authorised by us.
- * The appliance is still in the possession of the original purchaser.

All service work under this guarantee must be undertaken by a Zanussi Service Force Centre. Any appliance or defective part replaced shall become our property.

Exclusions

This guarantee does not cover:

- * Damage or calls resulting from transportation, improper use or neglect, the replacement of any light bulbs or removable parts of glass or plastic.
- * Cost incurred for calls to put right machines improperly installed or calls to machines outside the UK.
- * Appliances found to be in use within a commercial environment, plus those which are subject of rental agreements.

OR FIVE YEARS

Zanussi 5 Year Cover Conditions

For a once-only payment you can extend your Standard Guarantee, all the conditions and exclusions of which apply.

1. The issue of a cover does NOT by virtue of our having done so, nullify the exclusions.
2. The engineer will need to check the details of your Cover Certificate and will make a charge for his services if it is not presented to him at the time of his call.
3. The date of purchase, or the date of initial payment (deposit) of the appliance will be deemed the date of commencement of cover.
4. Covers issued are not refundable or transferable.
5. Change of address: Zanussi Cover Certificate is valid throughout the UK including the Isle of Man, Channel Islands, Northern Ireland and does not require amending. Advice in writing, quoting the 'Cover' Card number is necessary to enable correction of records.

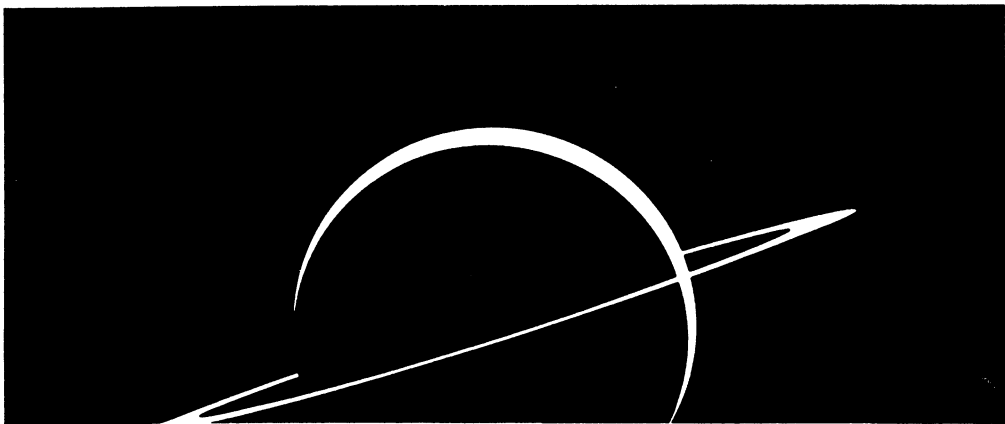

ZANUSSI

The appliance of science

Zanussi Ltd., Zanussi House, Newbury

The information in this manual is correct at time of going to press.
Zanussi reserve the right to alter specifications without notice.