

use & care guide

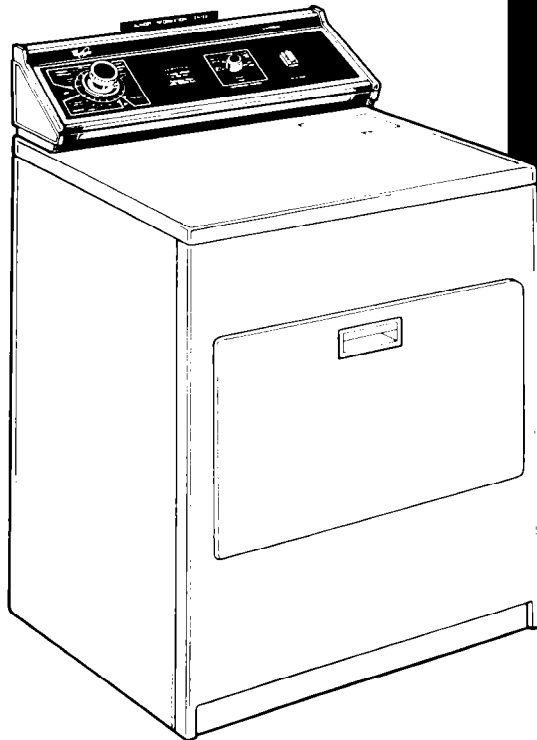
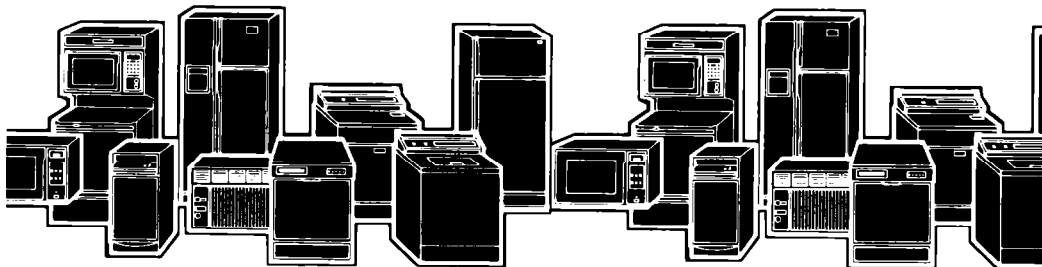

AUTOMATIC DRYERS

**Electric Model
LE7800XM
and
Gas Model
LG7801XM**

Wave Ovens, Trash Compactors, Room Air Conditioners, Dehumidifiers, Automatic Washers, Clothes Dryers, Freezers, Refrigerator-Freezers



Parts and features

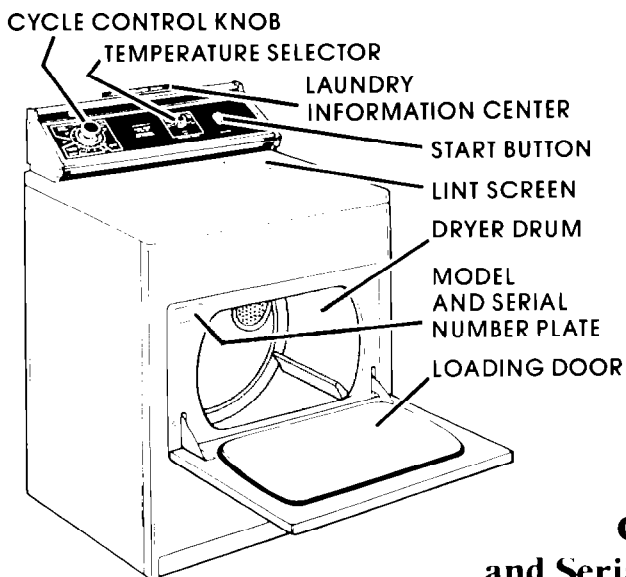

Remove the Consumer Buy Guide label before using your dryer. It will be easier to remove.

Wipe out the dryer drum with a damp cloth to remove dust from storing or shipping.

See your "Dryer Guide" for information on fabrics, drying special-care items, drying tips and other details.

Copy your Model and Serial Numbers here

When you need service or call with a question, have this information ready:

- 1. Complete** Model and Serial Numbers (from the plate located as shown).
- 2.** Purchase date from sales slip.

Copy this information in these spaces. Keep this book, your warranty, sales slip and "Dryer Guide" in the Laundry Information Center on the back of the dryer console.

There is no warranty registration to return. Proof-of-purchase is all that is required for in-warranty service.

Complete Model Number

Complete Serial Number

Purchase Date

Service Company and Telephone Number

Contents

	Page		Page
PARTS AND FEATURES	2	End-of-Cycle Signal	8
YOUR RESPONSIBILITIES	3	Drying Rack	8
SAFETY FIRST	3	LINT SCREEN	9
SELECTING A CYCLE AND		LINT REMOVAL	9
STARTING YOUR DRYER	4	CARING FOR YOUR DRYER	10
OPERATING INSTRUCTIONS	6	Vacation Care	10
Automatic Cycles	6	IF YOU NEED SERVICE OR	
Timed Drying	6	ASSISTANCE	11
DRYING TIPS	7	1. Before Calling for	
FLUFF AIR Setting	7	Assistance	11
TUMBLE PRESS Control	7	2. If You Need Assistance	11
FINISH GUARD Control	7	3. If You Need Service	11
Drying Times	7	4. If You Have a Problem	11
Mixed Loads	7		

Your Responsibilities

Read this "Use and Care Guide" and your "Dryer Guide" carefully for important use and safety information.

You are personally responsible for making sure that your dryer...

- is installed by a qualified installer.
- is properly maintained.
- is installed in an area protected from the weather.
- is properly installed and leveled in a well ventilated room* on a floor that can support the weight.

- is located in an area where the temperature is above 45 F (7.2 C).
 - is connected to the right kind of outlet, electric supply and grounding.*
 - is properly connected to fuel and exhaust systems.*
 - is used only for jobs normally expected of home clothes dryers.
 - is not run where there may be explosive fumes.
 - is not used by children or anyone unable to operate it properly.
- *See the "Installation Instructions" for complete information.

Safety first

ALWAYS unplug the power supply cord or turn off electrical power before attempting to service the dryer. Shut off the **GAS VALVE** if yours is a gas dryer.

ALWAYS shut off the gas valve before leaving on vacation.

NEVER use flammable fluids (dry-cleaning solvents, gasoline, kerosene) in or near your dryer.

ALWAYS hand launder or air dry fabrics treated with flammable fluids before putting them into your dryer.

NEVER dry items containing wax or paint in the dryer. The fumes can create a **FIRE HAZARD**.

FIRE HAZARD and DAMAGE to some materials can result from:

- drying heat-sensitive materials with heat (see page 4).
- operating the dryer with the lint screen loose, damaged or missing.
- allowing lint to build up inside the dryer (see page 8).

NEVER allow children to operate, play with, or crawl inside the dryer.

NEVER operate the dryer if...

- it is not working right.
- it is damaged.
- parts are missing.
- all panels are not in place.

DO NOT let dust, lint, paper, rags, chemicals, etc., pile up around or under the dryer. **DO NOT** install against drapes or curtains.

• FOR YOUR SAFETY •

IF YOU SMELL GAS:

1. OPEN WINDOWS.
2. DON'T TOUCH ELECTRICAL SWITCHES.
3. EXTINGUISH ANY OPEN FLAME.
4. IMMEDIATELY CALL GAS SUPPLIER.

• FOR YOUR SAFETY •

DO NOT STORE OR USE GASOLINE OR OTHER FLAMMABLE VAPORS AND LIQUIDS IN THE VICINITY OF THIS OR ANY OTHER APPLIANCE.

• SAVE THESE INSTRUCTIONS •

Selecting a cycle and starting your dryer

Before starting your dryer, be sure laundry is sorted and loaded properly (see your "Dryer Guide"). **Be sure the door is tightly closed.**

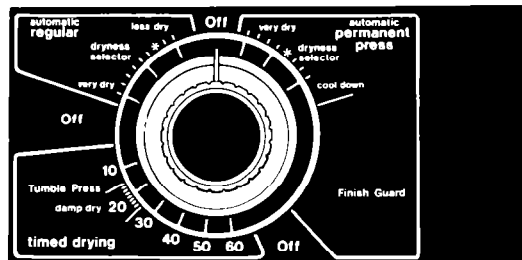

TYPE OF LOAD	SUGGESTED CYCLE	SUGGESTED TEMPERATURE
COTTONS – LINENS		
EXTRA HEAVY – Bedspreads, mattress pads, quilts		HEAVY/HIGH
HEAVYWEIGHT FABRICS – Towels, jeans, corduroys, work clothes	AUTOMATIC REGULAR	
MEDIUMWEIGHT COTTONS – Sheets, pillowcases, cotton underwear, diapers		PERM'T PRESS/MEDIUM
LIGHTWEIGHT COTTONS – Batistes, organdies, lingerie		KNITS/LOW
PERMANENT PRESS, SYNTHETICS AND BLENDS		
HEAVYWEIGHT FABRICS – Work clothes, jackets, raincoats	AUTOMATIC PERM'T PRESS	PERM'T PRESS/MEDIUM
MEDIUMWEIGHT FABRICS – Shirts, play clothes, sheets, slacks		
LIGHTWEIGHT FABRICS – Lingerie, blouses, dresses		KNITS/LOW
KNITS		
HEAVYWEIGHT – Cottons, rayons, blends, T-shirts, slacks, shirts	AUTOMATIC PERM'T PRESS	PERM'T PRESS/MEDIUM
LIGHTWEIGHT – Synthetics (polyester, acrylic, etc.) and blends, lingerie, blouses, dresses		KNITS/LOW
LIGHTWEIGHT AND DELICATE FABRICS		
Sheer Curtains (2 or 3 panels) Gauze, lace, etc.	AUTOMATIC PERM'T PRESS	GENTLE/EX LOW
RUBBER, PLASTIC, HEAT-SENSITIVE FABRICS		
FOAM RUBBER – Pillows, bras, stuffed toys	20-30 MINS.	FLUFF AIR
PLASTIC – Shower curtains, tablecloths	20-30 MINS.	
RUBBER-BACKED RUGS	40-50 MINS.	
OLEFIN, POLYPROPYLENE, SHEER NYLON	15-20 MINS.	
<p>Drying these and other heat-sensitive materials can damage them or be a FIRE HAZARD.</p> 		

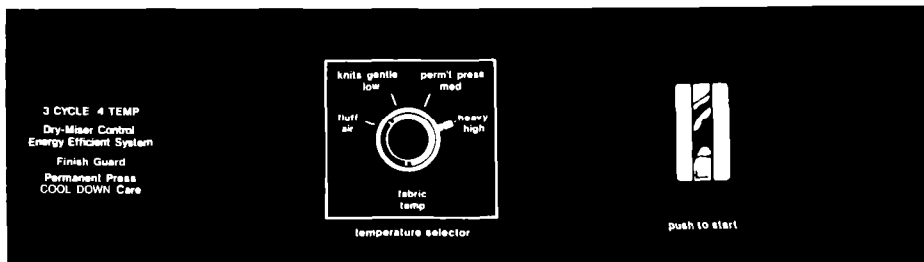

Select a 1. CYCLE

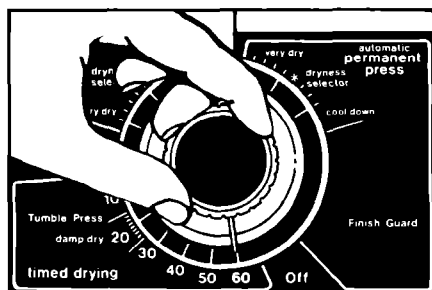

Turn the Control Knob either way to point to the cycle and setting you want. See page 6 for information on the cycles.

Set TEMPERATURE 2. SELECTOR

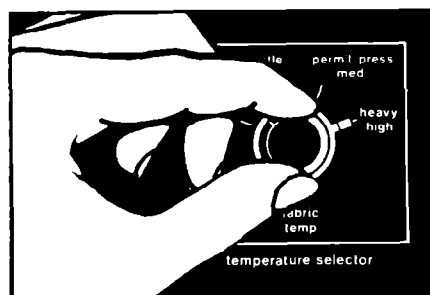

Turn the Temperature Selector to the needed drying temperature.

Push the 3. START Button

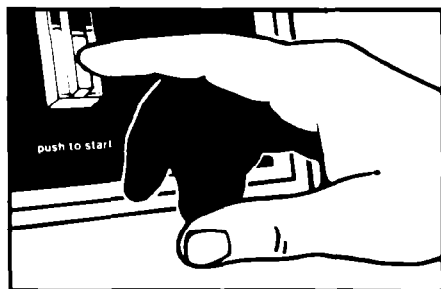

The dryer will start tumbling when you push the START Button.

To stop and restart the dryer

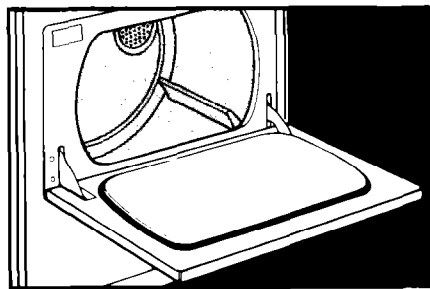

To stop the dryer, open the door (or turn the Control Knob to OFF).

To restart the dryer, close the door, select cycle, if necessary, and push START.

Changing a setting

The setting can be changed at any time by turning the Control Knob to a new setting.

The Cycle Control Knob should point to OFF when the dryer is not in use.

Operating instructions

The automatic cycles

The automatic cycles allow you to select the degree of dryness you prefer for the clothes being dried.

The Control Knob moves and stops several times until the load reaches the dryness setting you selected. Then the knob automatically moves to OFF and tumbling stops.



For the first few loads, set the Control Knob to point to an* in either automatic cycle. When the dryer stops, feel the dried items.

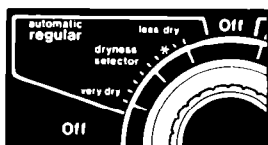

Use **AUTOMATIC REGULAR** to dry heavy and medium-

weight cotton items. **The load tumbles without heat during the last 5 minutes.** This helps make the load easier to handle.

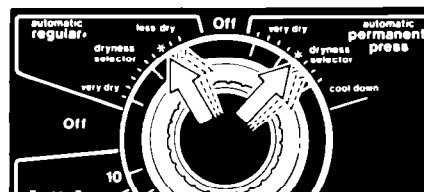

- If items are drier than you like, use a setting to the right of the* the next time you dry a similar load.

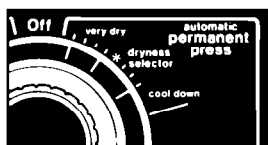

Use **AUTOMATIC PERMANENT PRESS** to dry permanent

press, knits and other synthetic fabrics. **The load tumbles without heat during the last 10 minutes.** This helps keep wrinkles from setting in.

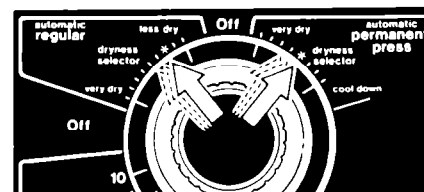

- If items are not as dry as you like, use a setting to the left of the* the next time you dry a similar load.

OVERDRYING CAN CAUSE SHRINKAGE, STATIC CLING AND DAMAGE TO SOME FABRICS.

Timed drying

Use the **TIMED DRY Cycle** for any load you want to dry by time. For example: small loads, large bulky items, items to be fluffed or dusted with the **FLUFF AIR** heat setting.

- Turn the Control Knob to the number of minutes you want – from 10 to 60.
- The last 5 minutes of this cycle are without heat – a cool down time. This helps make the load easier to handle.

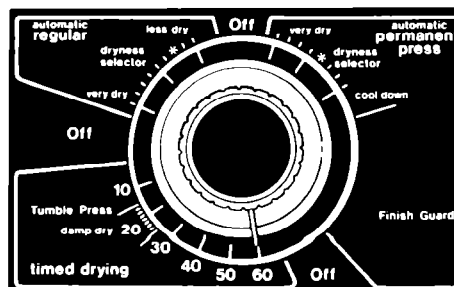

Drying tips

FLUFF AIR

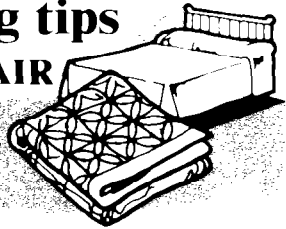

The dryer does not heat when the Temperature Selector is set on FLUFF AIR. This setting can be used to fluff bedding, plastic tablecloths, foam rubber pillows, stuffed toys, sneakers, etc.



Drying plastic or rubber items with heat may damage the items or be a FIRE HAZARD.

1. Turn the Temperature Selector to FLUFF AIR.
2. Turn the Control Knob to the number of minutes you want in the TIMED DRYING Cycle.
3. Push the START Button.

TUMBLE PRESS[®] Setting

The TUMBLE PRESS setting removes wrinkles from dry clothing.

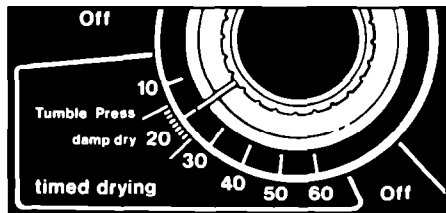

1. Set Control Knob to TUMBLE PRESS.
2. Set Temperature Selector to PERM'T PRESS/MED.
3. Push START Button.

The load will tumble in heated air for 5 minutes. The heat shuts off and the dryer continues to tumble the load for 10 more minutes.

For best results, TUMBLE PRESS only a few items at a time. Put them on hangers or fold them as soon as the dryer stops.

FINISH GUARD[®] Control

When you are not able to unload the dryer as soon as it stops, wrinkles can form.

If you don't open the door within 5 minutes after the dryer stops, FINISH GUARD takes over automatically to protect the load. You don't have to set the Control Knob for FINISH GUARD.

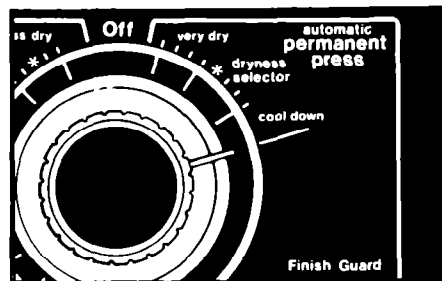

FINISH GUARD tumbles the load, without heat, every 5 minutes for up to 40 minutes. This tumbling rearranges and fluffs the load to help avoid the wrinkles that set in when the load remains in the warm dryer.

Drying times

Drying times will vary depending on:

- amount of moisture in the clothes.
- type and weight of the fabric.
- size of the load.
- room temperature around the dryer.
- temperature of the wash/rinse water.
- amount of lint in the lint screen.
- dryer temperature selection.

See page 6 in your "Dryer Guide" for more information.

Mixed loads



When drying a load with different kinds and weights of fabrics, use the cycle suggested for the lightest fabrics. When the dryer stops, remove dry items and reset the control.

End-of-cycle signal



The dryer sounds a signal to let you know when the cycle is finished. The signal cannot be turned off and is not adjustable.

The signal is helpful when you are drying permanent press, synthetics and other items that should be taken out as soon as the dryer stops.

Using the drying rack

The drying rack lets you dry items that you may not want to tumble: for example, sneakers, stuffed toys, knitted wool, etc.

The rack does not move, but the drum turns. **Make sure nothing hangs over the edges of the rack.**

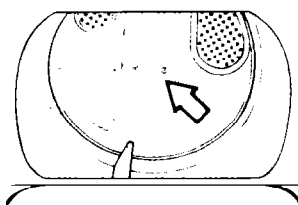

1. Rear legs on the rack fit into indents in the back wall of the dryer.

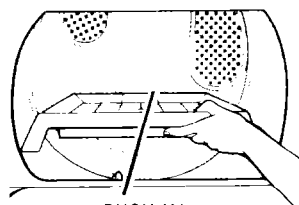

2. Fit rear legs into indents. Push in against the springs in the legs.

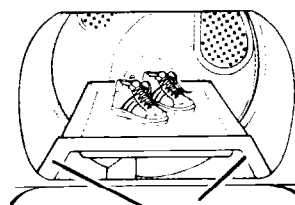

3. Lower the front so legs rest on dryer opening.

4. Put wet items on top of the rack. Leave space between them so air can reach all surfaces.

5. Close the door; set time and temperature; push the START Button.

Use a setting in the TIMED DRY Cycle. Drying time will depend on how much moisture the items hold. The following chart suggests temperature settings for different kinds of items that might best be rack dried.

To rack dry...	Use Temperature setting...
Wool sweaters (Block to shape and lay flat on the rack.)	KNITS GENTLE LOW
Stuffed toys or pillows (Cotton or polyester fiber filled.)	PERM'T PRESS MED.
Stuffed toys or pillows* (Foam rubber filled)	FLUFF AIR
Sneakers or canvas shoes*	FLUFF AIR

 ***WARNING: Drying with heat may damage the foam rubber and will be a FIRE HAZARD.**

Be sure to take the rack out for normal tumble drying.

Lint screen

Clean the lint screen before each load. A screen blocked by lint can increase drying time and may be a FIRE HAZARD.

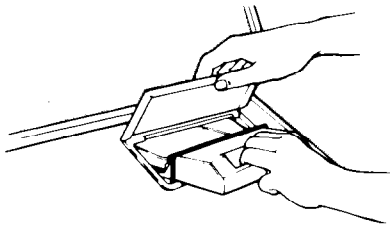

Open the lid and pull the lint screen straight out.



DO NOT run the dryer with the lint screen loose, damaged or missing. Doing so can cause overheating, can damage fabrics and can be a **FIRE HAZARD**.

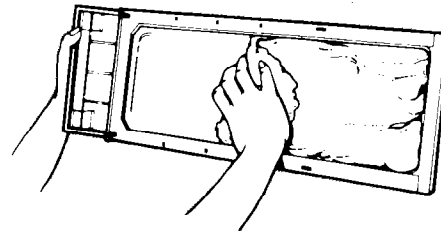

ROLL the lint off the screen with your fingers.

DO NOT rinse or wash the screen.

Push the screen firmly back into place.

DRYING TIPS • LINT SCREEN • LINT REMOVAL

Lint removal

Lint can gather inside the dryer and create a fire hazard. **This lint should be removed every 2 to 3 years, or more often, depending on dryer usage.**

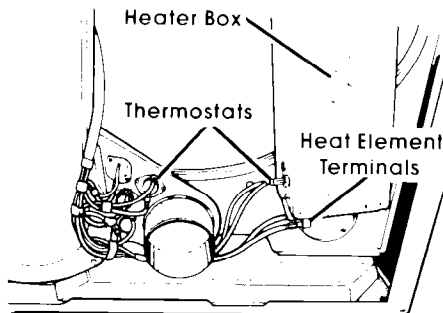

ELECTRIC DRYERS

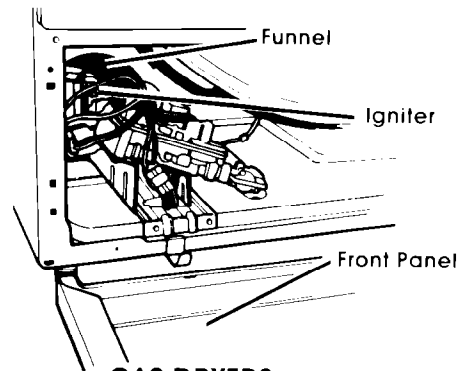

GAS DRYERS

Cleaning should be done only by a qualified person.



- Avoid electrical shock hazard – unplug power supply cord or turn off electrical power.
- Avoid injury or damage – do not put hands inside cabinet.
- Make sure dryer is cool.

1. Remove back panel (electric) or front panel (gas).
2. Avoid damaging wires, thermostats, funnel or igniter.
3. Remove lint from shaded area – see art – with a soft brush or vacuum cleaner.
4. Replace panel; reconnect and re-level dryer.

Caring for your dryer

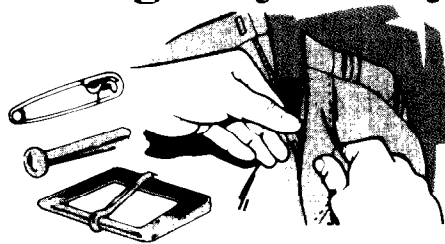

Remove sharp objects from clothing before drying – pins, buckles, etc. **Close metal zippers.**

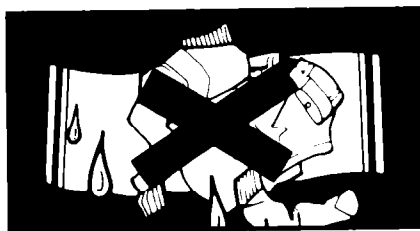

Never leave wet or damp laundry in your dryer.



Wipe off all spills with a damp, soft cloth. Spills allowed to remain may dull or damage the finish.

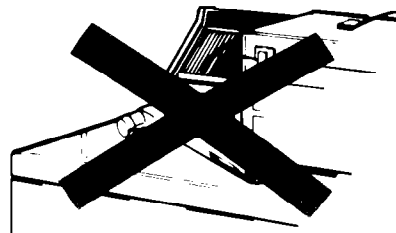

Sharp or heavy objects should never be put on or in the dryer. Check pockets for bolts, nuts, etc.

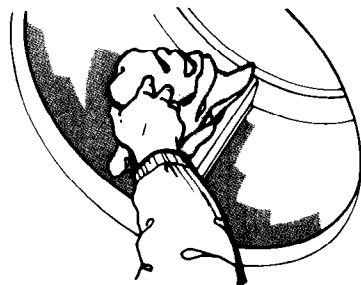

Non-colorfast items can stain the drum. Wipe **carefully** after drying to make sure there is no dye to be transferred to items in the next load.

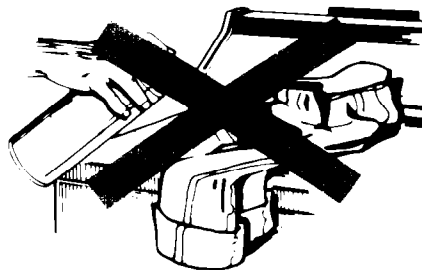

Some pretreatment products can damage dials, console and finish. Do not use these products on or near your dryer.

Vacation care

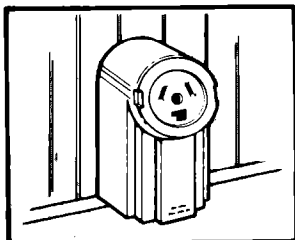

Disconnect power supply cord.

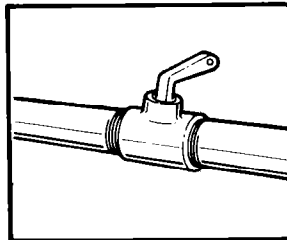

For gas dryers, close gas valve.

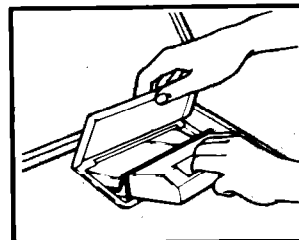

Clean lint screen.

If you need service or assistance, we suggest you follow these four steps:

1. Before calling for assistance...

Performance problems often result from little things you can find and fix yourself without tools of any kind.

DRYER DOES NOT RUN:

- Is power supply cord plugged in?
- Is door closed tightly?
- Did you push START Button?
- Are fuses blown or a circuit-breaker tripped?

DRYER DOES NOT HEAT:

- The AIR setting is without heat.
- The last minutes of heat settings are without heat.
- Is gas turned on? If not, turn Control Knob to OFF. Turn on gas. Wait 5 minutes. Reset controls and start.
- An electric dryer has two fuses, if not a circuit-breaker. If one is blown, the dryer may run, but not heat.

DRYING TIME SEEMS LONG:

- Is the lint screen clean?
- See page 6 in your "Dryer Guide."

2. If you need assistance*...

Call Whirlpool COOL-LINE® service assistance telephone number. Dial free from:

Continental U.S. . . (800) 253-1301
Michigan (800) 632-2243
Alaska & Hawaii (800) 253-1121

and talk with one of our trained Consultants. The Consultant can instruct you in how to obtain satisfactory operation from your appliance or, if service is necessary, recommend a qualified service company in your area.

3. If you need service*...



Whirlpool has a nationwide network of franchised TECH-CARE® Service Companies. TECH-CARE service technicians are trained to fulfill

the product warranty and provide after-warranty service, anywhere in the United States. To locate TECH-CARE service in your area, call our COOL-LINE service assistance telephone number (see Step 2) or look in your telephone directory Yellow Pages under:

APPLIANCES - HOUSEHOLD - MAJOR - SERVICE & REPAIR OR ELECTRICAL APPLIANCES - MAJOR - REPAIRING & PARTS
WHIRLPOOL APPLIANCES - FRANCHISED TECH-CARE SERVICE OR WHIRLPOOL APPLIANCES - FRANCHISED TECH-CARE SERVICE
SERVICE COMPANIES XYZ SERVICE CO. 123 Maple 999-9999 OR SERVICE COMPANIES XYZ SERVICE CO. 123 Maple 999-9999
OR
WASHING MACHINES, DRYERS & IRONERS - SERVICING
WHIRLPOOL APPLIANCES - FRANCHISED TECH-CARE SERVICE
SERVICE COMPANIES XYZ SERVICE CO. 123 Maple 999-9999

4. If you have a problem*...

Call our COOL-LINE service assistance telephone number (see Step 2) and talk with one of our Consultants, or if you prefer, write to:

Mr. Guy Turner, Vice President
Whirlpool Corporation
Administrative Center
2000 US-33 North
Benton Harbor, MI 49022

If you must call or write, please provide: model number, serial number, date of purchase, and a complete description of the problem. This information is needed in order to better respond to your request for assistance.



FSP is a registered trademark of Whirlpool Corporation for quality parts. Look for this symbol of quality whenever you need a replacement part for your Whirlpool appliance.

FSP replacement parts will fit right and work right, because they are made to the same exacting specifications used to build every new Whirlpool appliance.

CARING FOR YOUR DRYER • IF YOU NEED SERVICE OR ASSISTANCE



Making your world a little easier.

Part No. 691270

Printed in U.S.A.

Automatic Washers, Clothes Dryers, Freezers, Refrigerator-Freezers, Ice Makers, Dishwashers, Built-In Ovens and Surface Units, Ranges, Mi

