

# use & care guide

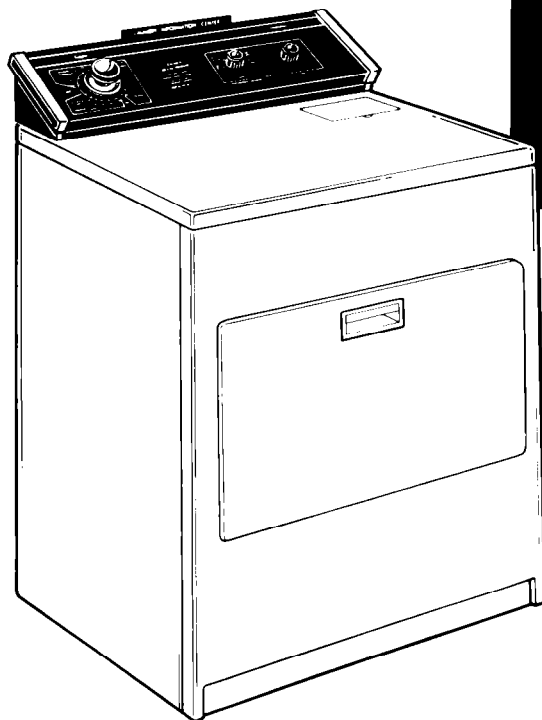

  
**Whirlpool**

## **AUTOMATIC DRYERS**

**Electric Model  
LE7680XP  
and  
Gas Model  
LG7681XP**

Wave Ovens, Trash Compactors, Room Air Conditioners, Dehumidifiers, Automatic Washers, Clothes Dryers, Freezers, Refrigerator-Freezers

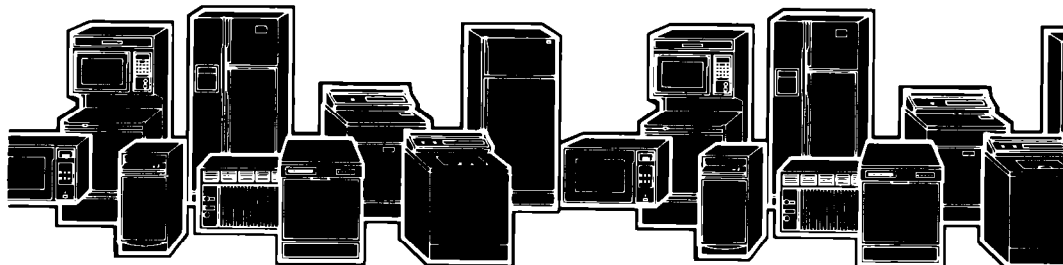

# Parts and features

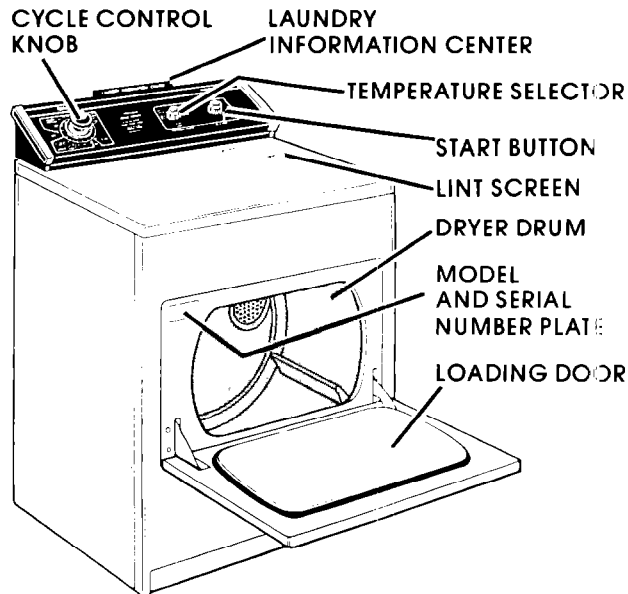

Remove the Consumer Buy Guide label before using your dryer. It will be easier to remove.

Wipe out the dryer drum with a damp cloth to remove dust from storing or shipping.

## Copy your Model and Serial Numbers here

When you need service or call with a question, have this information ready:

1. Complete Model and Serial Numbers (from the plate located as shown).
2. Purchase date from sales slip.

Copy this information in these spaces. Keep this book, your warranty, sales slip and "Dryer Guide" in the Laundry Information Center on the back of the dryer console.

There is no warranty registration to return. Proof-of-purchase is all that is required for in-warranty service.

\_\_\_\_\_

Complete Model Number

\_\_\_\_\_

Complete Serial Number

\_\_\_\_\_

Purchase Date

\_\_\_\_\_

Service Company and Telephone Number

## Contents

	Page		Page
<b>PARTS AND FEATURES</b> .....	2	Mixed loads .....	8
<b>YOUR RESPONSIBILITIES</b> .....	3	End-of Cycle Signal .....	8
<b>SAFETY FIRST</b> .....	3	Lint Signal .....	8
<b>SELECTING A CYCLE AND STARTING YOUR DRYER</b> .....	4	<b>LINT SCREEN</b> .....	9
<b>OPERATING INSTRUCTIONS</b> ..	6	<b>LINT REMOVAL</b> .....	9
Automatic Cycles .....	6	<b>CARING FOR YOUR DRYER</b> .....	10
Timed Drying .....	6	<b>IF YOU NEED SERVICE OR ASSISTANCE</b> .....	11
<b>DRYING TIPS</b> .....	7	1. Before Calling for Assistance .....	11
FLUFF AIR Setting .....	7	2. If You Need Assistance ...	11
TUMBLE PRESS® Setting .....	7	3. If You Need Service .....	11
Gentle Heat .....	7	4. If You Have a Problem ...	11
Drying Times .....	8		

# Your Responsibilities

Read this "Use and Care Guide" and your "Dryer Guide" carefully for important use and safety information.

You are personally responsible for making sure that your dryer...

- is installed by a qualified installer.
- is properly maintained.
- is installed in an area protected from the weather.
- is properly installed and leveled in a well ventilated room\* on a floor that can support the weight.

- is located in an area where the temperature is above 45°F (7.2°C).
  - is connected to the right kind of outlet, electric supply and grounding.\*
  - is properly connected to fuel and exhaust systems.\*
  - is used only for jobs normally expected of home clothes dryers.
  - is not run where there may be explosive fumes.
  - is not used by children or anyone unable to operate it properly.
- \*See the "Installation Instructions" for complete information.

## Safety first

**ALWAYS** unplug the power supply cord or turn off electrical power before attempting to service the dryer. **Shut off the GAS VALVE** if yours is a gas dryer.

**ALWAYS** shut off the gas valve before leaving on vacation.

**NEVER** use flammable fluids (dry-cleaning solvents, gasoline, kerosene) in or near your dryer.

**ALWAYS** hand launder or air dry fabrics treated with flammable fluids before putting them into your dryer.

**NEVER** dry items containing wax or paint in the dryer. The fumes can create a **FIRE HAZARD**.

**FIRE HAZARD** and **DAMAGE** to some materials can result from:

- drying heat-sensitive materials with heat (see page 4).
- operating the dryer with the lint screen loose, damaged or missing.
- allowing lint to build up inside the dryer (see page 9).

**NEVER** allow children to operate, play with, or crawl inside the dryer.

**NEVER** operate the dryer if...

- it is not working right.
- it is damaged.
- parts are missing.
- all panels are not in place.

**DO NOT** let dust, lint, paper, rags, chemicals, etc., pile up around or under the dryer. **DO NOT** install against drapes or curtains.

### • FOR YOUR SAFETY •

#### IF YOU SMELL GAS:

1. OPEN WINDOWS.
2. DON'T TOUCH ELECTRICAL SWITCHES.
3. EXTINGUISH ANY OPEN FLAME.
4. IMMEDIATELY CALL YOUR GAS SUPPLIER.

### • FOR YOUR SAFETY •

**DO NOT STORE OR USE GASOLINE OR OTHER FLAMMABLE VAPORS AND LIQUIDS IN THE VICINITY OF THIS OR ANY OTHER APPLIANCE.**

• SAVE THESE INSTRUCTIONS •



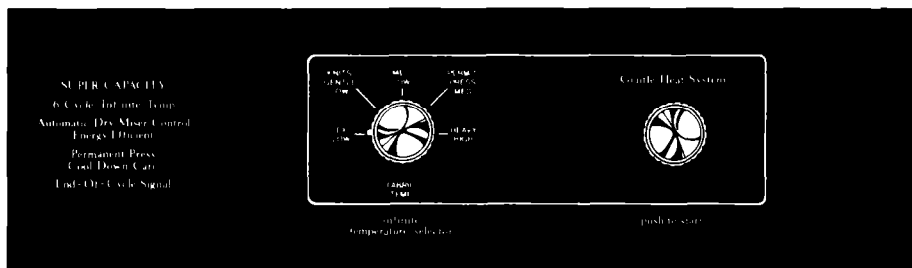

## 1. Select a CYCLE

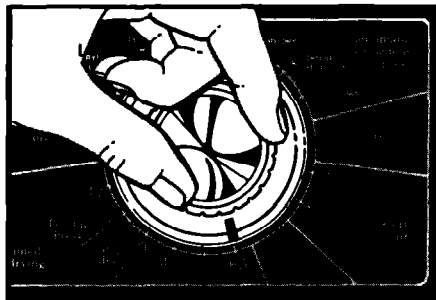

Turn the Control Knob either way to point to the cycle and setting you want. See page 6 for information on the cycles.

## 2. Set TEMPERATURE SELECTOR

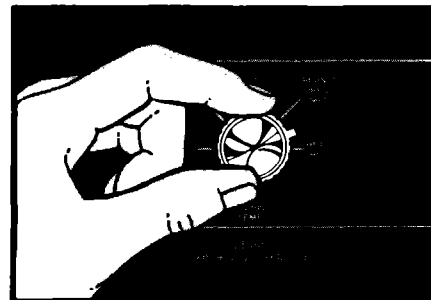

The Temperature Selector can be set on any desired drying temperature or anywhere between two temperatures.

## 3. Push the START Button

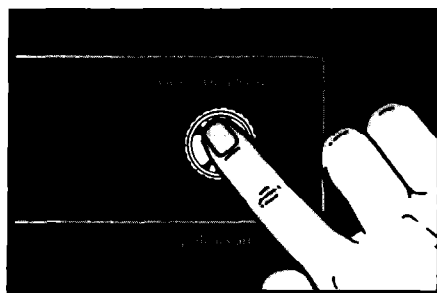

The dryer will start tumbling when you push the START Button.

## To stop and restart the dryer

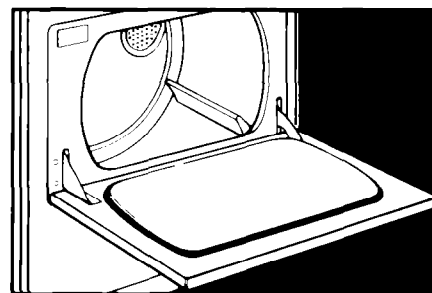

**To stop** the dryer, open the door (or turn the Control Knob to OFF).  
**To restart** the dryer, close the door, select cycle, if necessary, and push START.

**The Cycle Control Knob should point to OFF when the dryer is not in use.**

# Operating instructions

## The automatic cycles

The automatic cycles allow you to select the degree of dryness you prefer for the clothes being dried.

The Control Knob moves and stops several times until the load reaches the dryness setting you selected. Then the knob automatically moves to OFF and tumbling stops.

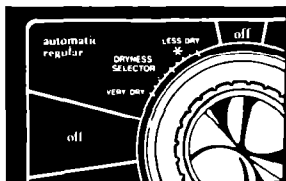

Use **AUTOMATIC REGULAR** to dry heavy and medium-

weight cotton items. **The load tumbles without heat during the last 5 minutes.** This helps make the load easier to handle.

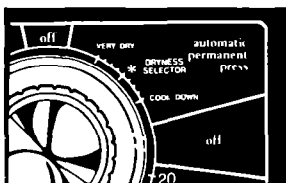

Use **AUTOMATIC PERMANENT PRESS** to dry permanent

press, knits and other synthetic fabrics. **The load tumbles without heat during the last 10 minutes.** This helps keep wrinkles from setting in.

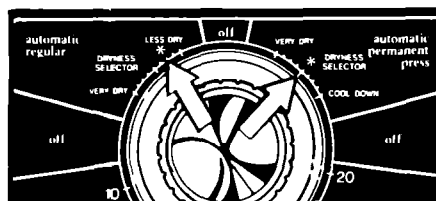

For the first few loads, set the Control Knob to point to an \* in either automatic cycle. When the dryer stops, feel the dried items.

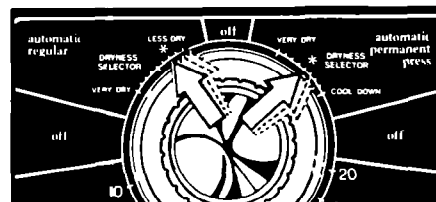

- If items are drier than you like, use a setting to the right of the \* the next time you dry a similar load.

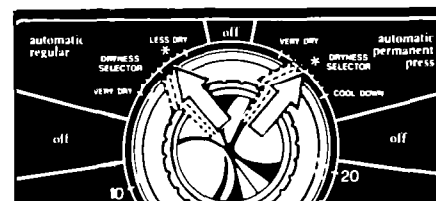

- If items are not as dry as you like, use a setting to the left of the \* the next time you dry a similar load.

**OVERDRYING CAN CAUSE SHRINKAGE, STATIC CLING AND DAMAGE TO SOME FABRICS.**

## Timed drying

Use the **TIMED DRYING** Cycle for any load you want to dry by time. For example: small loads, large bulky items, items to be fluffed or dusted with the **FLUFF AIR** heat setting.

- Turn the Control Knob to the number of minutes you want – from 10 to 60.
- The last 5 minutes of this cycle are without heat – a cool-down time. This helps make the load easier to handle.

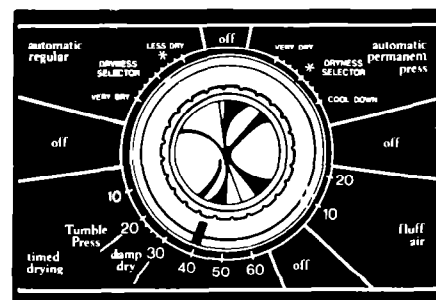

## Drying tips

### FLUFF AIR

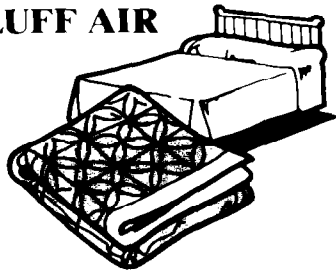

The dryer does not heat when the Control Knob is set on FLUFF AIR. This setting can be used to fluff bedding, plastic tablecloths, foam rubber pillows, stuffed toys, sneakers, etc.

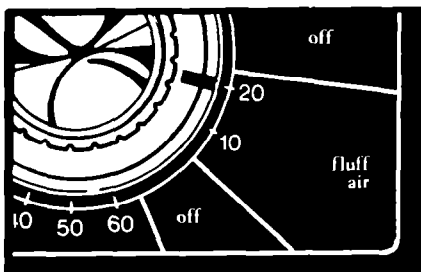

1. Turn the Control Knob to the number of minutes you want in FLUFF AIR.
2. Push the START Button.

**WARNING: Drying plastic or rubber items with heat may damage the items or be a FIRE HAZARD.**

### TUMBLE PRESS® Setting

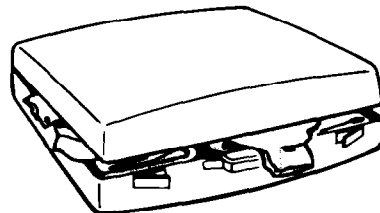

The TUMBLE PRESS setting removes wrinkles from dry clothing such as items that may have been packed in a suitcase, closet, or items not removed from the dryer.

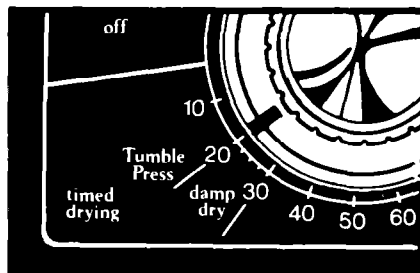

1. Set Control Knob to TUMBLE PRESS.
2. Set Temperature Selector to PERM'T PRESS / MED
3. Push START Button.

The load will tumble in heated air for 10 minutes. The heat shuts off and the dryer continues to tumble the load for 5 more minutes.

For best results, TUMBLE PRESS only a few items at a time. Put them on hangers or fold them as soon as the dryer stops.

### Gentle Heat

The dryer automatically reduces the heat setting in HEAVY HIGH and PERM'T PRESS MED cycles. The last 7 minutes of each of these cycles gradually reduces the dryer temperature to a lower heat setting. This helps prevent over drying.

## Drying times



Drying times will vary depending on:

- amount of moisture in the clothes.
- type and weight of the fabric.
- size of the load.
- room temperature around the dryer.
- temperature of the wash rinse water.
- amount of lint in the lint screen.
- dryer temperature selection.

See page 6 in your "Dryer Guide" for more information.

## Mixed loads

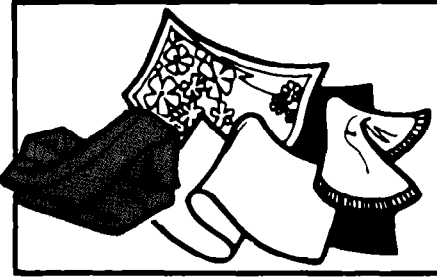

When drying a load with different kinds and weights of fabrics, use the cycle suggested for the lightest fabrics. When the dryer stops, remove dry items and reset the control.

## End-of-cycle signal



The dryer sounds a signal to let you know when the cycle is finished. The signal cannot be turned off and is not adjustable.

The signal is helpful when you are drying permanent press, synthetics and other items that should be taken out as soon as the dryer stops.

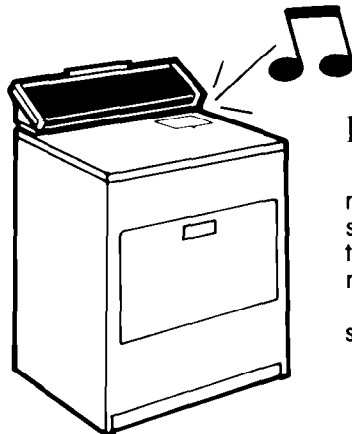

## Lint signal

Clean lint screen **before each load**. If you neglect to clean your lint screen, the signal will sound. The (whistle tone) signal lets you know the air flow is being restricted. Restricted air flow reduces drying efficiency.

Turn off the dryer and clean the lint screen as shown on page 9.



## Lint screen

**Clean the lint screen before each load.** A screen blocked by lint can increase drying time and may be a FIRE HAZARD.

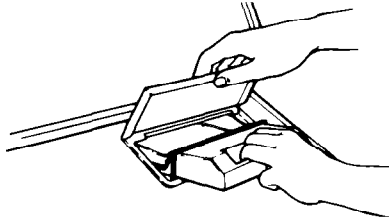

Open the lid and pull the lint screen straight out.

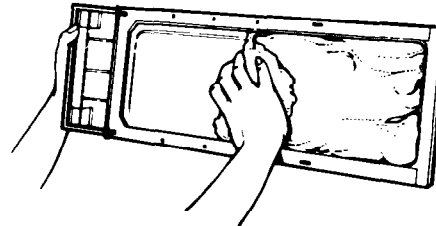

**ROLL** the lint off the screen with your fingers.

**DO NOT** rinse or wash the screen.

Push the screen firmly back into place.

**WARNING: DO NOT** run the dryer with the lint screen loose, damaged or missing. Doing so can cause overheating, can damage fabrics and can be a **FIRE HAZARD**.

## Lint removal

Lint can gather inside the dryer and create a fire hazard. **This lint should be removed every 2 to 3 years, or more often, depending on dryer usage.**

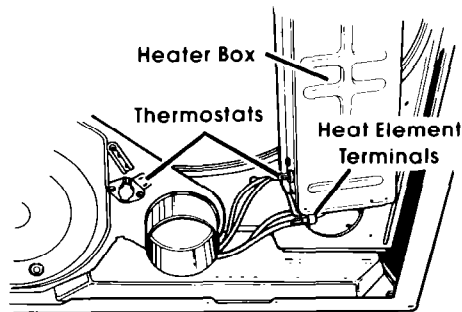

**ELECTRIC DRYERS**

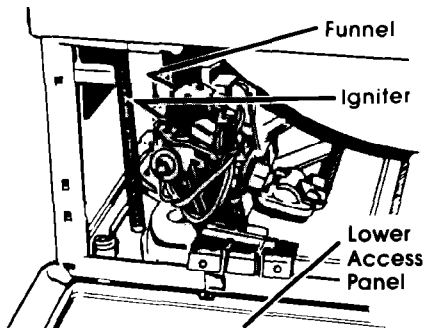

**GAS DRYERS**

**Cleaning should be done only by a qualified person.**



- Avoid electrical shock hazard – unplug power supply cord or turn off electrical power.
- Avoid injury or damage – do not put hands inside cabinet.
- Make sure dryer is cool.

1. Remove back panel (electric) or lower access panel (gas).
2. Avoid damaging wires, thermostats, funnel or igniter.
3. Remove lint from shaded area – see art – with a soft brush or vacuum cleaner.
4. Replace panel; reconnect and re-level dryer.

# Caring for your dryer



**Remove sharp objects** from clothing before drying – pins, buckles, etc.  
**Close metal zippers.**



**Never leave wet or damp laundry** in your dryer.



**Wipe off all spills** with a damp, soft cloth. Spills allowed to remain may dull or damage the finish.

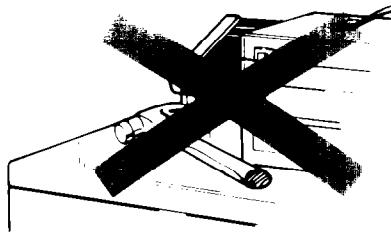

**Sharp or heavy objects** should never be put on or in the dryer. Check pockets for bolts, nuts, etc.

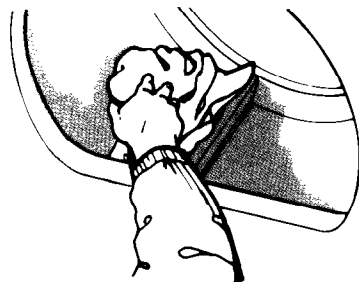

Non-colorfast items can stain the drum. Wipe **carefully** after drying to make sure there is no dye to be transferred to items in the next load.

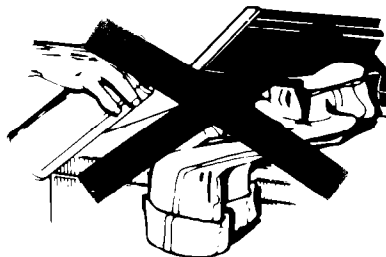

**Some pretreatment products** can damage dials, console and finish. Do not use these products on or near your dryer.

## Vacation care

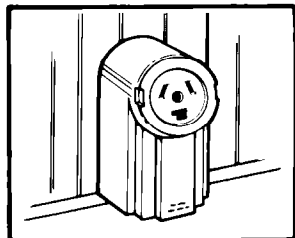

Unplug power cord or turn off electrical power.

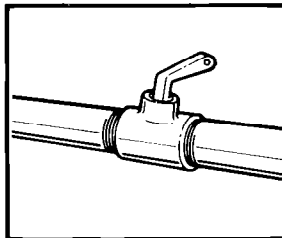

For gas dryers, close gas valve.

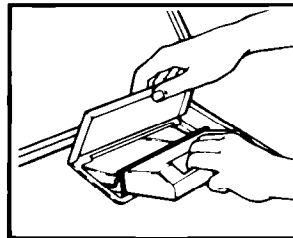

Clean lint screen.

# If you need service or assistance, we suggest you follow these four steps:

## 1. Before calling for assistance... 3. If you need service\*...

Performance problems often result from little things you can find and fix yourself without tools of any kind.

### DRYER DOES NOT RUN:

- Is power supply cord plugged in?
- Is door closed tightly?
- Did you push START Button?
- Are fuses blown or a circuit-breaker tripped?

### DRYER DOES NOT HEAT:

- The AIR setting is without heat.
- The last minutes of heat settings are without heat.
- Is gas turned on? If not, turn Control Knob to OFF. Turn on gas. Wait 5 minutes. Reset controls and start.
- An electric dryer uses a circuit breaker or 2 fuses. If one fuse is blown, the dryer may run, but not heat.

### DRYING TIME SEEMS LONG:

- Is the lint screen clean?
- See page 6 in your "Dryer Guide."

## 2. If you need assistance\*...

Call Whirlpool COOL-LINE® service assistance telephone number. Dial free from:

Continental U.S. . . (800) 253-1301  
Michigan . . . . . (800) 632-2243  
Alaska & Hawaii (800) 253-1121

and talk with one of our trained Consultants. The Consultant can instruct you in how to obtain satisfactory operation from your appliance or, if service is necessary, recommend a qualified service company in your area.



FSP is a registered trademark of Whirlpool Corporation for quality parts. Look for this symbol of quality whenever you need a replacement part for your Whirlpool appliance. FSP replacement parts

will fit right and work right, because they are made to the same exacting specifications used to build every new Whirlpool appliance



Whirlpool has a nationwide network of franchised TECH-CARE® Service Companies. TECH-CARE serv-

ice technicians are trained to fulfill the product warranty and provide after-warranty service, anywhere in the United States. To locate TECH-CARE service in your area, call our COOL-LINE service assistance telephone number (see Step 2) or look in your telephone directory Yellow Pages under:

APPLIANCES-HOUSEHOLD- MAJOR-SERVICE & REPAIR	OR	ELECTRICAL APPLIANCES- MAJOR-REPAIRING & PARTS
WHIRLPOOL APPLIANCES FRANCHISED TECH-CARE SERVICE		WHIRLPOOL APPLIANCES FRANCHISED TECH-CARE SERVICE
SERVICE COMPANIES		
XYZ SERVICE CO 123 Maple . . . . . 999-9999		XYZ SERVICE CO 123 Maple . . . . . 999-9999
OR		
WASHING MACHINES, DRYERS & IRONERS-SERVICING		
WHIRLPOOL APPLIANCES FRANCHISED TECH-CARE SERVICE		
SERVICE COMPANIES		
XYZ SERVICE CO 123 Maple . . . . . 999-9999		

## 4. If you have a problem\*...

Call our COOL-LINE service assistance telephone number (see Step 2) and talk with one of our Consultants, or if you prefer, write to:

Mr. Stephen E. Upton  
Senior Vice President  
Whirlpool Corporation  
Administrative Center  
2000 US-33 North  
Benton Harbor, MI 49022

\*If you must call or write, please provide: model number, serial number, date of purchase, and a complete description of the problem. This information is needed in order to better respond to your request for assistance.

