

Miele

TOUCHTRONIC

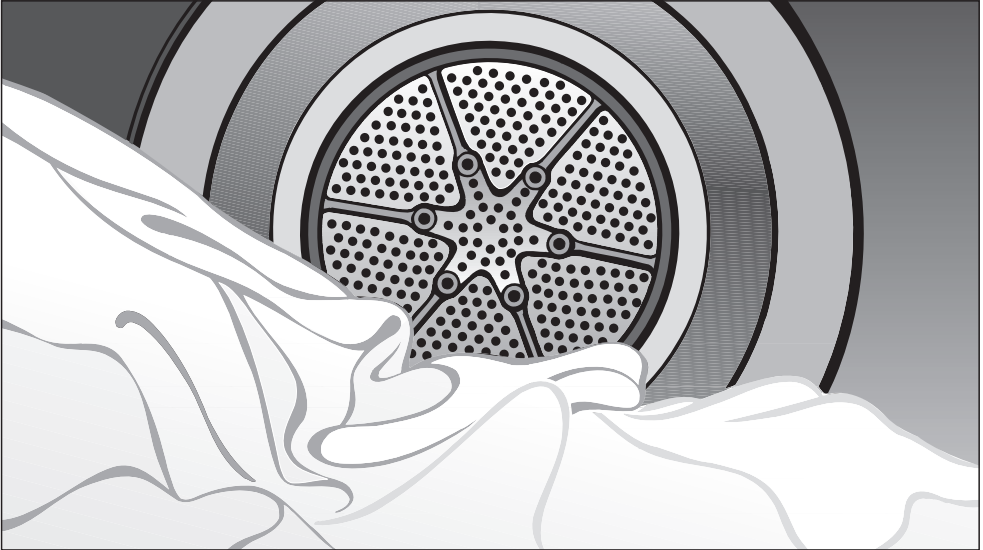

Operating Instructions Condenser Dryer T 1323 C

To prevent accidents
and machine damage
read these instructions
before
installation or use.

HT11

















M.-Nr. 06 002 890

Contents

IMPORTANT SAFETY INSTRUCTIONS	3
Control panel	5
Before loading the dryer	6
Using the dryer	7
1. Turn on the dryer and load the laundry	7
2. Select a program	7
3. Select a drying option (if needed)	9
4. Select the dryness level	10
5. Select the buzzer (if desired)	10
6. Start the program	11
7. At the end of a program	11
Canceling or changing a program	12
Adding or removing laundry during a program	12
Child lock	13
Dryer care	14
Cleaning the lint filter	14
Cleaning the exterior and the control panel	15
Cleaning the drum	15
Emptying the condensed water container	16
Quick Guide	17
Dryer care	17
Cleaning the condenser	17
Changing the light bulb	19
Frequently asked questions	20
Technical Service	22
Installation instructions	23
IMPORTANT SAFETY INSTRUCTIONS	24
Caring for the environment	25
Washer / Dryer Stack	26
Electrical connection	27
Installation	28
Installation tips	29
Leveling the dryer	29
External water drain	30

IMPORTANT SAFETY INSTRUCTIONS

 **WARNING** - To reduce the risk of fire, electric shock, or injury to persons when using your appliance, follow basic precautions, including the following:

-  Read all instructions before using the appliance.
-  Do not dry articles that have been previously cleaned, washed, soaked or spotted with gasoline, dry-cleaning solvents or other flammable or explosive substances. They may give off vapors that could ignite or explode.
-  Do not allow children to play on or in the appliance. Close supervision is necessary when the appliance is used near children. Always close the door after use to prevent child hazards.
-  Before this appliance is removed for service or discarded, remove the door to the drying compartment.
-  Do not reach into the dryer if the drum is moving.
-  Do not install or store this appliance where it will be exposed to the weather.
-  Do not tamper with the controls.
-  Do not repair or replace any part of the appliance or attempt any servicing unless specifically recommended in these operating instructions. Repairs to electrical appliances should only be performed by qualified personnel. Incorrectly repaired machines may pose a considerable risk to the user.
-  Do not use fabric softener sheets to eliminate static in this dryer. Best results are achieved when a liquid softener is used in the washer.
-  Do not use heat to dry articles containing foam rubber or similarly textured rubber-like materials, or items containing hair spray, nail polish remover or similar substances.
-  Clean the lint filter before or after each load.
-  Keep the area around the air intake (toekick) and adjacent surrounding areas free from lint, dust and dirt.
-  The interior of the machine should be cleaned periodically by qualified personnel.
-  Do not place items exposed to oils in your dryer. Items contaminated with oils may contribute to a chemical reaction that could cause the laundry to catch fire.

This dryer is intended for residential use only!

IMPORTANT SAFETY INSTRUCTIONS

GROUNDING INSTRUCTIONS

■ This appliance must be grounded. In the event of malfunction or breakdown, grounding will reduce the risk of electric shock by providing a path of least resistance for electric current.

This appliance is equipped with a cord having an equipment grounding conductor and a grounding plug. The plug must be plugged into an appropriate outlet that is properly installed and grounded in accordance with all local codes and ordinances.

■ **WARNING** – Improper connection of the equipment-grounding conductor can result in a risk of electric shock. Contact a qualified electrician if you are in doubt as to whether the appliance is properly grounded.

■ Do not modify the plug provided with the appliance: if it will not fit the outlet, have a proper outlet installed by a qualified electrician.

SAVE THESE INSTRUCTIONS

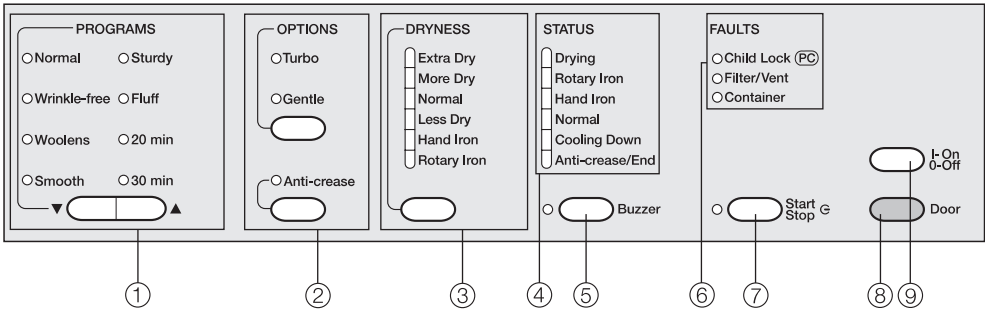

① ▼▲ "PROGRAMS" buttons

For selecting a drying program.

② "OPTIONS" buttons

For selecting a drying option.

③ "DRYNESS" button

For selecting the dryness level of finished laundry.

④ "STATUS" display

Shows the current cycle of the drying program.

⑤ "Buzzer" button

When selected, a buzzer will sound at the end of a program.

⑥ "FAULT" indicators

An illuminated indicator will alert you if the child lock has been activated or if a fault occurred.

⑦ "Start/Stop" button G

Starts and stops a program.

Interrupts a program when pressed.

Flashes during program selection and lights once the program starts.

⑧ "Door" button

Opens the door when the program has finished. If the dryer is on, the drum interior will light when the door is opened. If the door is left open, the light will go off after a few minutes to save energy.

⑨ "On/Off" button

Turns power to the machine on and off.

Before loading the dryer

The dryer must be correctly installed and connected before the first use. Please refer to the "Installation Instructions".

- Before using for the first time clean the drum with a cloth.

Before drying, check fabric care labels for special drying instructions.

- Dry with normal temperature
- Dry with low temperature (select "Gentle" option)
- Do not dry in a tumble dryer

- Do not overload the drum! Overloading the dryer will result in poor drying results and wrinkling.
- **Knitted fabrics and flannel** tend to shrink when washed and dried for the first time. Do not overdry these fabrics.
- To prevent discoloration, do not dry **new, dark-colored fabrics** with light-colored items.
- Close zippers and tie up fabric belts and apron ties to prevent tangles and damage to clothing.
- Do not dry items that may melt or ignite in the dryer, such as plastics, rubber or sneakers.

Program recommendations

Normal

- Cottons and Permanent Press blends

Wrinkle-free

- Permanent Press: select the **Hand Iron** dryness and reduce the load size for best drying results
- Delicate fabrics, such as polyester: select the **Gentle** option to reduce creasing
- Pure linen and down filled items

Woolens

- Wool and wool blends

Smooth

- Linen
- Permanent Press (cottons, blends and synthetics)

Sturdy

- Durable Cottons and Permanent Press

Fluff / 20 min / 30 min

- All fabric types

1. Turn on the dryer and load the laundry

- Press the "On/Off" button to turn on the dryer.
- Press the "Door" button to open the door.
- Load the laundry loosely into the drum.
- Make sure the lint filters are in place.
- Close the door with a firm swing - do not push it shut.

For best results use liquid fabric softener when washing laundry. Fabric softener sheet may clog the filters and cause the dryer to overheat.

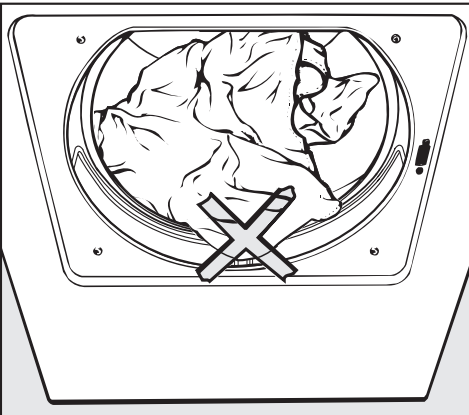

To prevent fabric damage, check that laundry will not be caught in the closed door.

2. Select a program

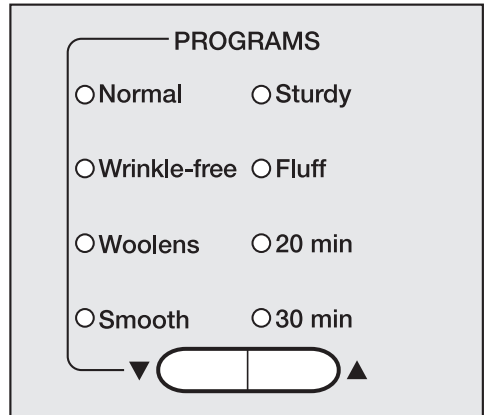

- Press the ▼ or ▲ button until the desired program indicator lights.

Using the dryer

Program	Fabric	Note
Normal	Available drying options: Turbo, Gentle, Anti-crease	
Extra Dry	Multi-layer fabrics, mixed loads of sturdy cottons, e.g. jeans, towels.	The "Extra dry" program should not be selected for jersey materials. Items may shrink.
More Dry	Uniform loads of cotton, e.g. sheets, underwear, socks.	-
Normal	Knitted cotton fabrics that may shrink, e.g. jersey material or lightweight cottons.	If items are still damp, dry again using "More Dry".
Less Dry	Cotton or linen fabrics to be left damp for ironing.	-
Hand Iron		If fabrics are too damp for ironing, dry again using "Less Dry".
Rotary Iron	Cotton or linen fabrics which will be ironed with a rotary iron.	To prevent moisture loss, roll up the laundry until ironing.
Wrinkle-free	Available drying options: Turbo, Gentle, Anti-crease	
More Dry	Synthetic permanent press items, e.g. pants and shirts.	-
Normal	Permanent press and blended fabrics, e.g. cotton/synthetic.	
Less Dry	Permanent press and blended fabrics requiring an ironed finish.	Reduce load size for fabrics that wrinkle easily.
Special Programs Available drying options: Anti-crease only available in Fluff, Sturdy		
Woolens	Delicate items which allow machine drying.	Remove items immediately after the end of the program while still slightly damp. Allow items to air dry.
Smooth	Program for reducing creasing of cotton, linen or permanent press fabrics made of cotton, blends or synthetics.	-
Sturdy	For mixed loads of cotton and permanent press items.	-
Fluff	Individual items to be freshened and fluffed with cool air.	Reduce load size.
TIMED CYCLES Available drying options: Gentle, Anti-crease		
20 min	Individual items or very small loads, e.g. beach towels, swimsuits.	-
30 min		

3. Select a drying option (if needed)

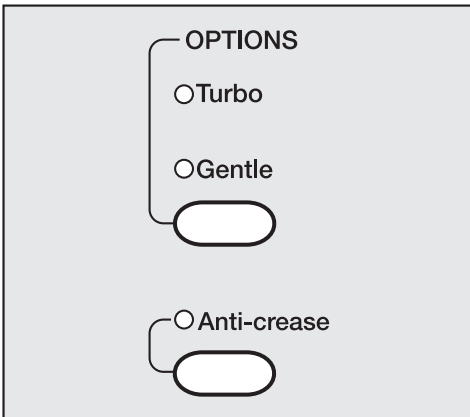

- A drying option can be selected or deselected with each press of the button.

OPTIONS

Turbo

Fast drying for sturdy fabrics with increased temperature and a reduced program length.

Gentle

For drying delicate fabrics slowly at a lower temperature.

Anti-crease

Prevents wrinkles if laundry is not removed immediately after the end of a program. The drum periodically rotates for about 1 hour.

Using the dryer

4. Select the dryness level

The dryness level can be selected in the "Normal" and "Wrinkle-free" programs. (The dryness level of the other programs cannot be adjusted.)

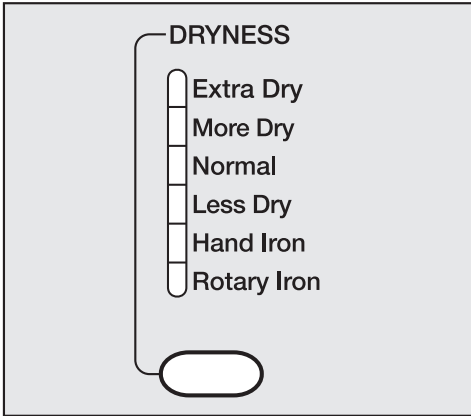

- Press the selection button until the desired indicator illuminates.

In the "Wrinkle-free" program, only "More Dry", "Normal" and "Less Dry" can be selected.

5. Select the buzzer (if desired)

- Press the "Buzzer" button to have a tone beep at the end of the program.

Indicator light:

- on = buzzer selected
- off = buzzer not selected

Adjusting the buzzer volume:

- the dryer must be on
- the door closed
- a program selected
- if the "Buzzer" indicator is lit, press the "Buzzer" button so its indicator light goes out.
- Press and hold the "Buzzer" button until its indicator lights and you hear the desired volume and tone.

6. Start the program

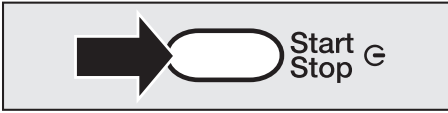

- Press the "Start/Stop" button.

Once the program starts, the current cycle of the program will be indicated in the "STATUS" display.

7. At the end of a program

The "Anti-crease/End" indicator will light at the end of a program and the buzzer will sound if it was selected.

If a fault occurred, a "FAULT" indicator will light. See "Frequently asked questions" for details.

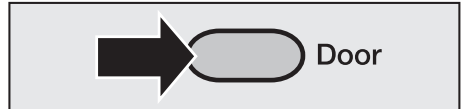

- Press the "Door" button.
- Open the door.
- Remove the laundry.
- Check that the drum is empty.
- Clean the lint filter after each use (see "Dryer care").
- Close the door.

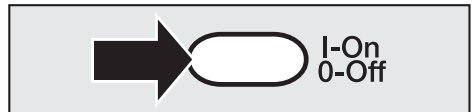



- Press the "On/Off" button to turn off the dryer.
- Empty the condensed water container weekly (if not connected to a drain).

Using the dryer

Canceling or changing a program

- Press and release the "Start/Stop 

To continue drying:

- Select the new program by pressing the  or  button.
- Select any desired options.
- Select a dryness level (available in the "Normal" and "Wrinkle-free" programs).
- Press and release the "Start/Stop 

Adding or removing laundry during a program

- Turn off the dryer using the "On/Off" button.
- Press the "Door" button.
- Open the door.

 CAUTION - Do not touch the rear of the drum while adding or removing items! There is a danger of burns due to high temperatures in the drum.

- Add or remove items.
- Close the door.
- Turn the dryer back on with the "On/Off" button.

Child lock

When activated, the child lock prevents the dryer from being operated by locking the control panel functions.

The dryer can be turned on but not started. The "Child lock" indicator will flash.

The door can be opened.

To activate the child lock

- 1.** Make sure the dryer is turned off and the door is closed.
- 2.** Press and hold the "Anti-crease" and "DRYNESS" buttons at the same time, hold until step 5.
- 3.** Turn on the dryer with the "On/Off" button.
- 4.** Press the "OPTIONS" button 3 times.
- 5.** Release the "Anti-crease" and "DRYNESS" buttons.

The "Child lock" indicator will flash and the dryer is now locked.

- 6.** Turn off the dryer using the "On/Off" button.

To deactivate the child lock

Repeat steps **1.** to **5.**

The "Child lock" indicator will go out.

The control panel is now unlocked.

- 6.** Turn off the dryer using the "On/Off" button.

Dryer care

Cleaning the lint filter

The lint filter must be cleaned after every program.

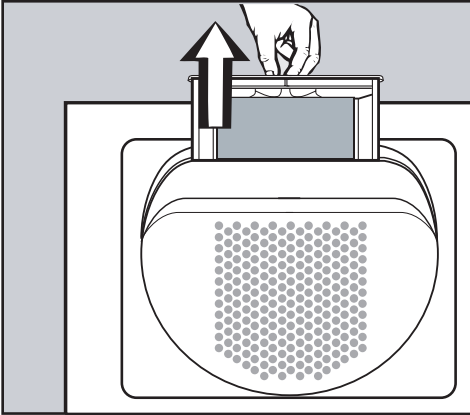

- Open the door and remove the lint filter by gently lifting it upwards.

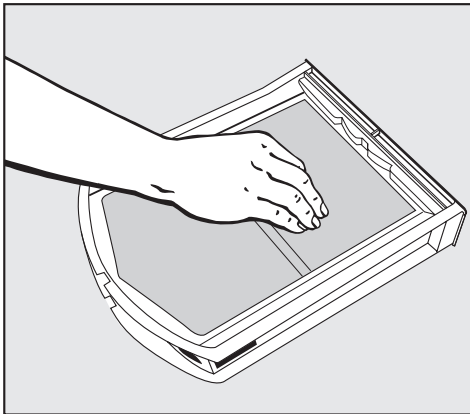

- Wipe the lint off the filter with your hand (do not use any sharp objects!)

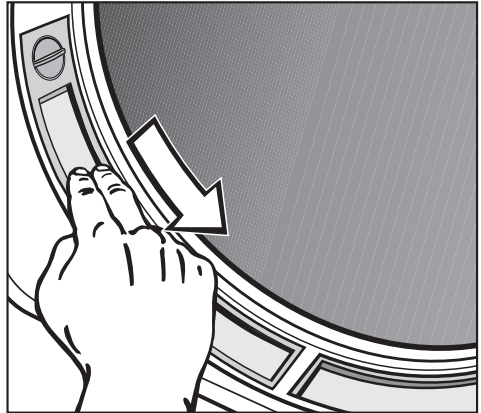

- Remove the lint from the door frame lint filter with your fingers.
- Any lint remaining in the hollow casing of the door can be removed through the gap at the bottom with a dust brush or vacuum.
- Return the lint filter and close the door.

The lint filters (once removed from the dryer) can be rinsed with hot water if necessary. The filters must be dried thoroughly before being returned to the dryer.

- Take the door lint filters out by turning the knob at the filter top.

Cleaning the exterior and the control panel

 To reduce the risk of electric shock, disconnect the dryer from the power supply by shutting off the power main, tripping the circuit breaker or unplugging the power cord before performing maintenance.

Never use abrasive cleaners, scouring pads, steel wool or caustic (oven) cleaners on the dryer. They will damage the surface.

- The exterior and the control panel can be cleaned with warm water and liquid dish soap applied with a soft sponge.
- Wipe dry.

Cleaning the drum

- The stainless steel surfaces of the drum can be cleaned using a non-abrasive stainless steel cleaner.
- Wipe clean with a soft cloth.

Dryer care

Emptying the condensed water container

Depending on the installation, the condensed water will either be pumped to a drain or collected in the condensed water container, located in the upper left corner of the machine.

The container holds approximately 1 gallon of water.

The container should be emptied weekly.

Should the container be full when the tumble dryer is started, or if it becomes full during normal operation:

- The "Container" indicator will light.
- The buzzer will sound.

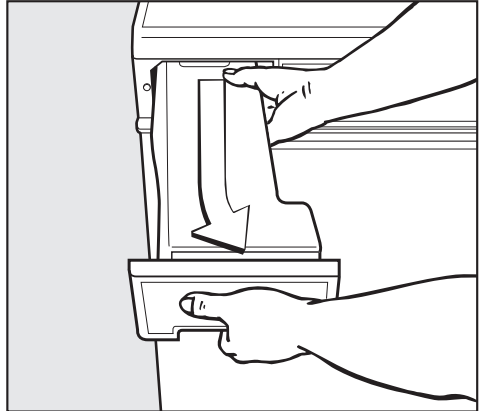

- Pull out the container slightly to the right with both hands.

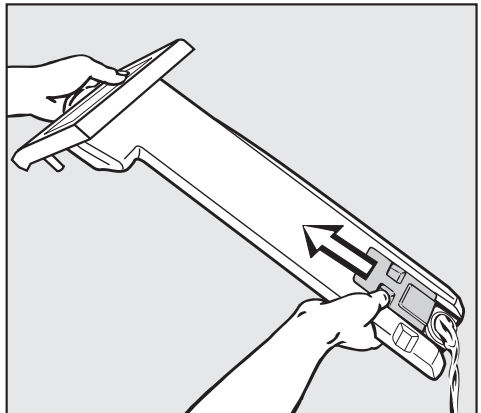

- Hold the cap open while emptying the container.
- When the container is empty, push it back into its opening until it clicks into place.
- Restart the drying program if needed.

Do not drink the condensed water!

Quick Guide

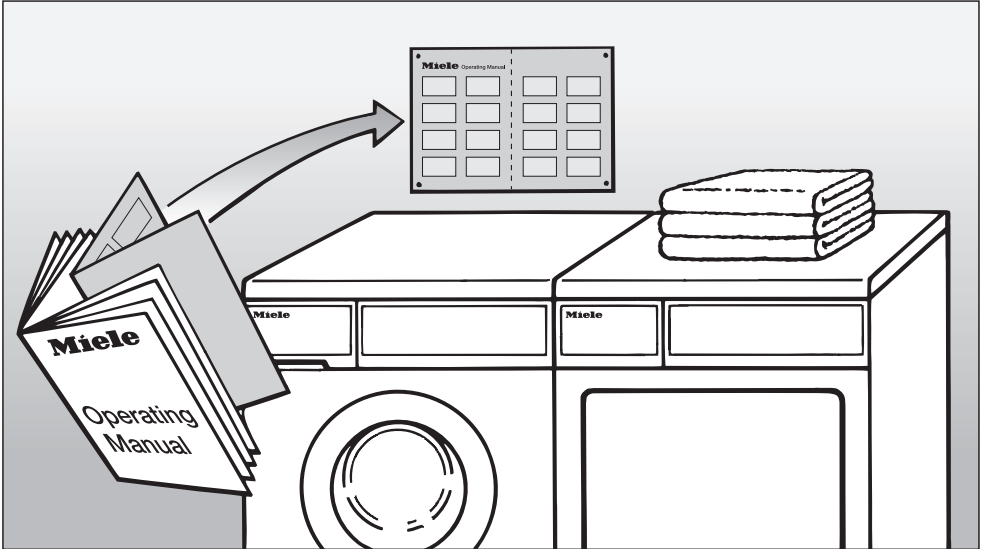

Remove this guide for easy reference

Please read all instructions, especially the "Important Safety Instructions", **before** using the dryer.

Quick Guide

1. Turn on the dryer and load the laundry

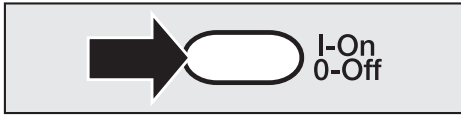

- Press the "On/Off" button to turn on the dryer.

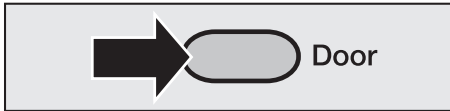

- Press the "Door" button to open the door.
- Load the laundry into the drum. Make sure that there is enough space in the drum for clothes to tumble freely.

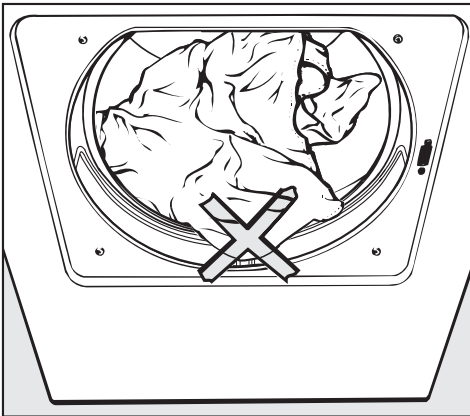

To prevent fabric damage, check that laundry will not be caught in the closed door.

- Close the door with a firm swing - do not push it shut.

2. Select a program

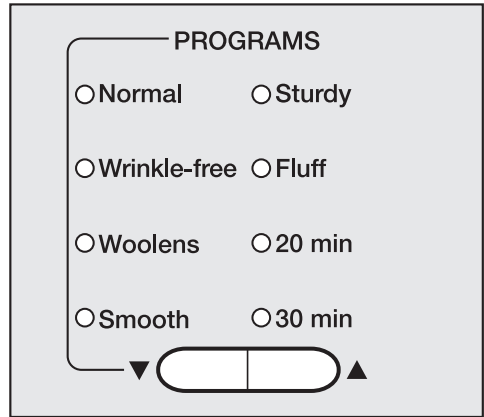

- Press the ▼ or ▲ button until the desired program indicator lights.

3. Select a drying option (if needed)

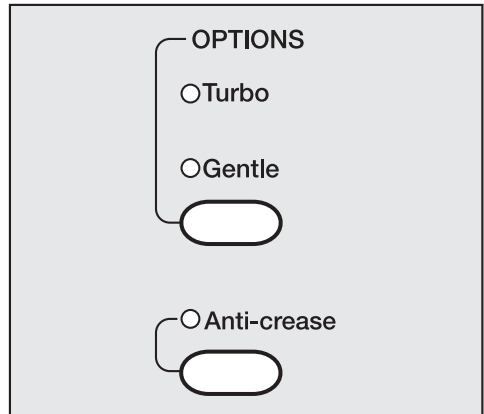

- A drying option can be selected or deselected with each press of the button.

4. Select the dryness level

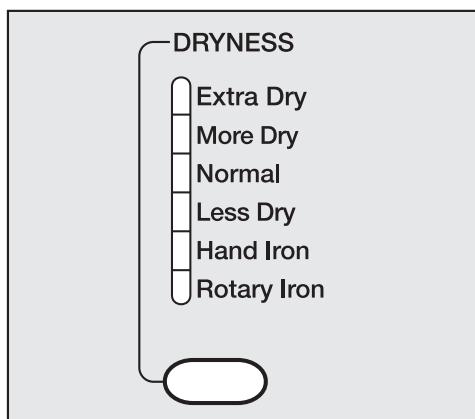

- Press the selection button until the desired indicator illuminates.

5. Select the buzzer (if desired)

6. Start the program

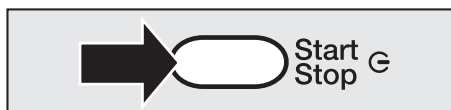

- Press the "Start/Stop" button.

7. At the end of a program

The "Anti-crease / End" indicator will light.

- Press "Door" and remove the laundry.
- Clean the lint filter.
- Press the "On/Off" button to turn off the dryer.

Quick Guide

Program	When to use	Note
Normal Available drying options: Turbo, Gentle, Anti-crease		
Extra Dry	For laundry to be folded and shelved immediately, e.g. jeans, towels.	The "Extra Dry" program should not be selected for jersey materials. Items may shrink.
More Dry	For uniform loads, e.g. sheets, underwear, socks.	-
Normal	For knitted items that may shrink, e.g. jersey material or lightweight cottons.	If items are still damp, dry again using "More Dry".
Less Dry	For items to be left damp for ironing.	-
Hand Iron		If fabrics are too damp, dry again using "Less Dry".
Rotary Iron	For items to be ironed with a rotary iron.	To prevent moisture loss, roll up the laundry until ready to iron.
Wrinkle-free Available drying options: Turbo, Gentle, Anti-crease		
More Dry	For items that do not require ironing, e.g. pants and shirts.	-
Normal	For items to be hung after drying.	
Less Dry	For items which require ironing.	Reduce load size for fabrics that wrinkle easily.

Special Programs Available drying options: Anti-crease only available in Fluff, Sturdy		
Woolens	Delicate items which allow machine drying.	Take items out immediately after the end of the program while still slightly damp. Allow items to air dry.
Smooth	Program for reducing creasing in delicate items.	-
Sturdy	For mixed loads of durable items.	-
Fluff	Individual items to be freshened and fluffed with cool air.	Reduce load size.
TIMED CYCLES Available drying options: Gentle, Anti-crease		
20 min	Individual items or very small loads,	-
30 min	e.g. beach towels, swimsuits.	

Cleaning the condenser

 To reduce the risk of electric shock, disconnect the dryer from the power supply by shutting off the power main, tripping the circuit breaker or unplugging the power cord before performing maintenance.

- Clean the condenser every 6 months.

Removing the condenser

The access panel to the condenser is located on the lower left corner of the dryer.

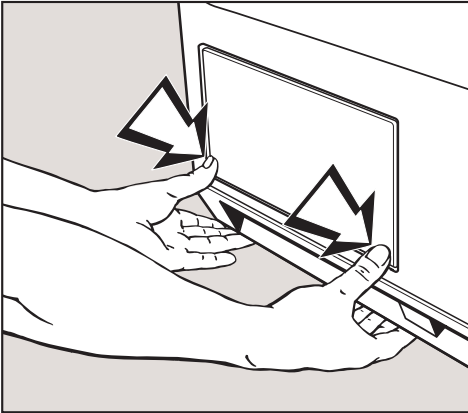

- Press on the lower corners of the access panel and lower it down.
- Remove the panel up and out of the condenser access area.

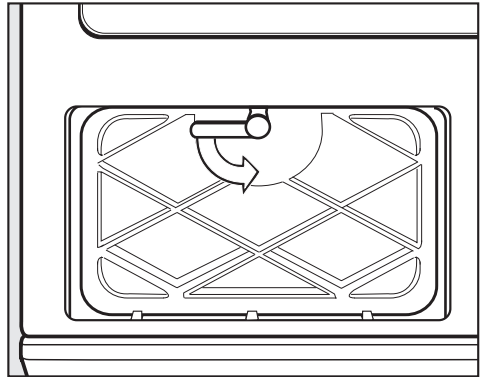

- Turn the condenser door lock down and remove the door.

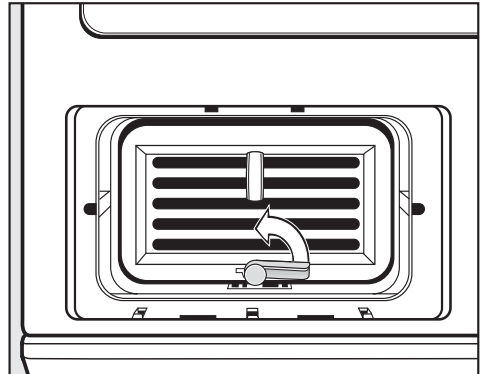

- Turn the condenser lock up.

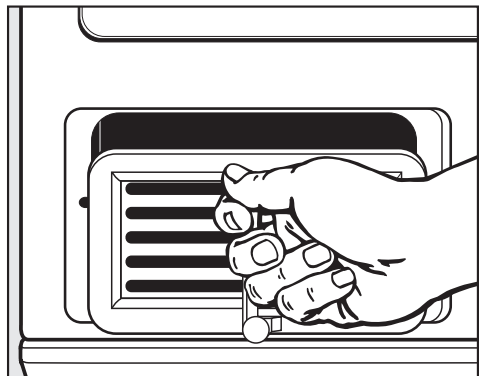

- Pull out the condenser.

Dryer care

Rinsing the condenser

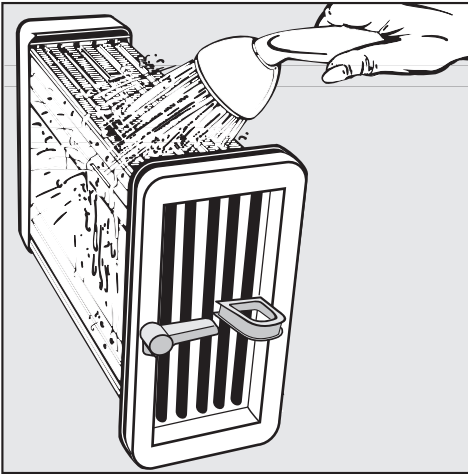

- Rinse the condenser along the left side with warm water.

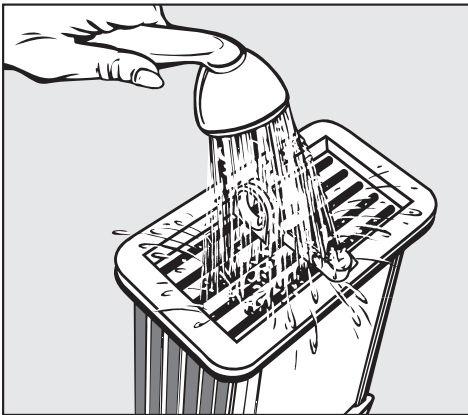

- Rinse the condenser from the front with warm water.
- Check the condenser for visible soiling. Rinse the condenser until clean.
- Place the condenser lengthwise on a towel to air dry.

Returning the Condenser

- Put the condenser back in place in the reverse order.

Check that the gasket around the front of the condenser is flush and not crimped.

- To prevent leaks, make certain the condenser is pushed in all the way and locked in place.
- Restore power.

Changing the light bulb

 To reduce the risk of electric shock, disconnect the dryer from the power supply by shutting off the power main, tripping the circuit breaker or unplugging the power cord before performing maintenance.

- Open the door.

The bulb cover is located along the upper rim of the drum opening.

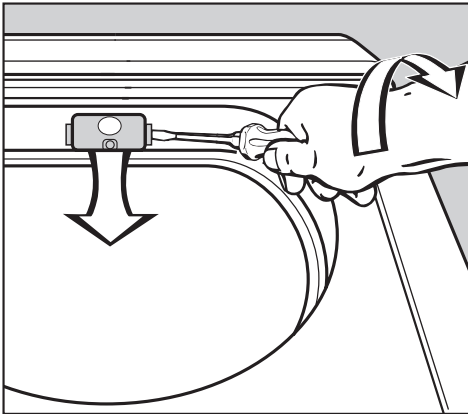

- Slide a screwdriver with a wide head underneath the side edge of the bulb cover and twist (see illustration).
- Flip down the bulb cover.

- Replace the light bulb with a temperature proof bulb, available from Miele.

The light bulb must not exceed the maximum wattage listed on the data plate.

- Flip up the light bulb cover and press it firmly until it clicks into place.

 Make sure the bulb cover is securely closed to prevent a short circuit or penetrating moisture.

- Restore power.

Frequently asked questions

What if the dryer will not run?	
Possible fault	Fix
The "Start/Stop" button was not pressed.	Make sure the dryer is on. Press the "Start/ Stop" button to begin the drying program.
The circuit breaker tripped or the dryer is unplugged.	Make sure the dryer is plugged in or reset the circuit breaker.
The door is not closed.	Close the door properly.
How do I prevent static cling?	
Add fabric softener to laundry when washing or select the "Less Dry" setting on the dryer. Do not use fabric softener sheets in this dryer.	
What if the drum light does not come on?	
Possible fault	Fix
The bulb may be bad or burned out.	See "Changing the light bulb."
What if the "Child Lock" indicator flashes after turning the dryer on and a program cannot be started?	
Possible fault	Fix
The child lock is activated.	Deactivate the child lock. See "Child Lock."
What if the program stops, the "Anti-crease/End" indicator lights and the buzzer sounds?	
Possible fault	Fix
The drum is empty.	Load laundry into the dryer. The dryer will not operate when the drum is empty. Single items should be dried with "Sturdy" or a timed program and dry items in the "Fluff" program.

Frequently asked questions

What if the "Filter/Vent" fault indicator is lit?

Possible fault	Fix
The lint filter is clogged.	Clean the lint filters. See "Dryer care".
The air supply in the room is insufficient.	Open a window or door to increase airflow.

What if the program runs too long or stops?

Possible fault	Fix
The airflow is insufficient in the area of the dryer.	Open a window or door to increase airflow.
The lint filters are clogged.	Clean the lint filters (see "Dryer care").
The laundry was not spun sufficiently in the washer.	Select a higher spin speed in the wash program.
The dryer is overloaded.	Reduce the load size.
Metal zippers interfere with the dryer's moisture sensors.	Select a timed program to avoid overdrying.
The condenser is clogged with lint or detergent residue.	Clean the condenser periodically (see "Dryer care").
The air vent below the door is blocked.	Remove any blockages.

What if the laundry is not dry enough?

Possible fault
The load contained too many dissimilar items (size and fabric.)

What if water has collected around the drum opening?

Possible fault
This is condensed moisture from the laundry.

Technical Service

In the event of a fault you cannot fix yourself, please contact the Miele Technical Service Department

USA 1-800-999-1360
techserv@mieleusa.com

CDN 1-800-565-6435
service@miele.ca

When contacting Technical Service, please quote the model and serial number of your appliance. They can be found on the data plate located below the drum opening.

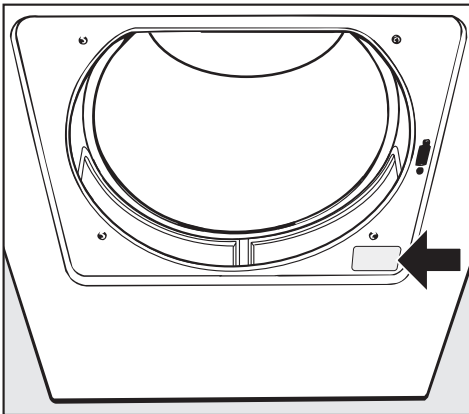

PC Update

The indicator on the control panel marked PC allows a technician to update the dryer to make use of new technology.

For example, if new programs or fabrics are developed, a service technician will be able to modify the existing program cycles accordingly.

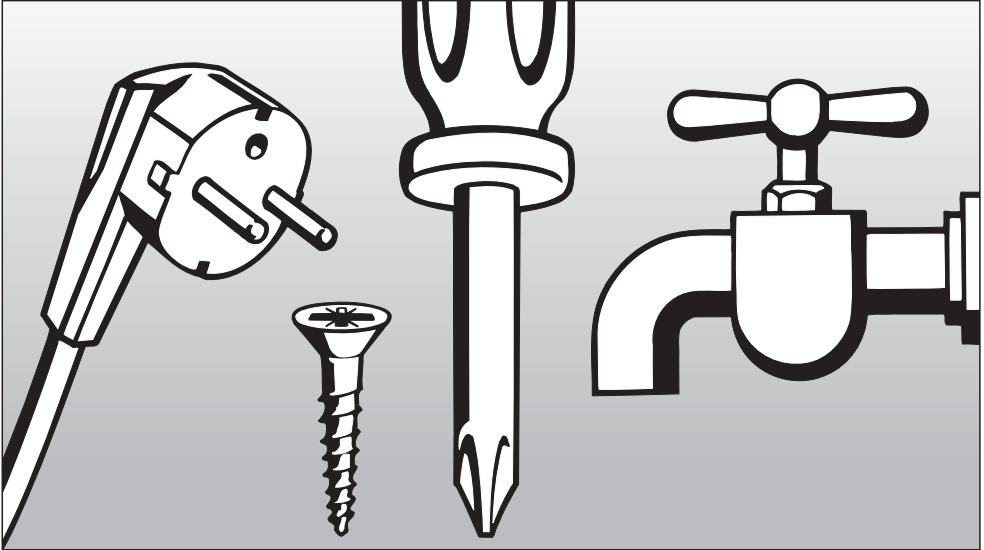

Installation Instructions

IMPORTANT SAFETY INSTRUCTIONS

■ Installation, repair and maintenance work should be performed by a Miele authorized service technician. Work by unqualified persons could be dangerous and could void the warranty. Be sure to observe local building codes.

■ Before installation, disconnect the tumble dryer from the electrical supply by shutting off the power main, unplugging the power cord or tripping the circuit breaker. Do not restore power until the installation is complete.

GROUNDING INSTRUCTIONS

■ This appliance must be grounded. In the event of malfunction or breakdown, grounding will reduce the risk of electric shock by providing a path of least resistance for electric current. This appliance is equipped with a cord having an equipment grounding conductor and a grounding plug. The plug must be plugged into an appropriate outlet that is properly installed and grounded in accordance with all local codes and ordinances.

■ **WARNING** – Improper connection of the equipment grounding conductor can result in a risk of electric shock. Check with a qualified electrician or service representative or personnel if you are in doubt as to whether the appliance is properly grounded.

■ Do not modify the plug provided with the appliance! If it will not fit the outlet, have a proper outlet installed by a qualified electrician.

■ If there is any doubt concerning installation, contact Miele's Technical Service Department.



1-800-999-1360
techserv@mieleusa.com



1-800-565-6435
service@miele.ca

Disposal of the packing materials

The cardboard box and packing materials protect the appliance during shipping. They have been designed to be biodegradable and recyclable.

To prevent suffocation of children, ensure that any plastic wrappings, bags, etc. are disposed of safely and kept out of the reach of children.

Disposal of an appliance

Old appliances may contain materials that can be recycled. Please contact your local recycling authority about the possibility of recycling these materials.

Ensure that a discarded dryer presents no danger to children. While being stored for disposal remove the door to the drying compartment.

Washer / Dryer Stack

The tumble dryer can also be placed on top of a Miele washing machine for a stacked installation. An appropriate stacking kit is required. The stacking kit is available from your Miele dealer or the Miele Technical Service Department.

 Installation of the stacking kit must be performed by a Miele authorized technician.

Height of a stacked installation

5' 6 ³/₈" (168.6 cm)
(Stacking kit with a pull out shelf)

GROUNDING INSTRUCTIONS

This appliance must be grounded. In the event of malfunction or breakdown, grounding will reduce the risk of electric shock by providing a path of least resistance for electric current. This appliance is equipped with a cord having an equipment grounding conductor and a grounding plug. The plug must be plugged into an appropriate outlet that is properly installed and grounded in accordance with all local codes and ordinances.

WARNING – Improper connection of the equipment grounding conductor can result in a risk of electric shock. Check with a qualified electrician or service representative or personnel if you are in doubt as to whether the appliance is properly grounded.

Do not modify the plug provided with the appliance! If it will not fit the outlet, have a proper outlet installed by a qualified electrician.

The dryer comes with a 5 ft long, 12/4 AWG cord and a NEMA 14-30 P plug.

It should be connected to a 120/208-240 V, 15 A, 60 Hz AC power supply. A 3 pole-4 wire grounding power outlet (NEMA type 14-30 R) is necessary.

EASY INSTALLATION KIT

If you do not have a dedicated 15 Amp line for this appliance, but you have the standard, 120/208-240 V - 30 Amp, 60 Hz AC outlet, you can use the "Easy Installation Kit", which allows you to use that line to connect the dryer to power.

057B for on-site outlet NEMA 10-30 R
060B for on-site outlet NEMA 14-30 R

For more information on the "Easy Installation Kit" or if you have questions concerning the electrical connection, please contact:

 1-800-999-1360
techserv@mieleusa.com

 1-800-565-6435
service@miele.ca

Installation

Front view

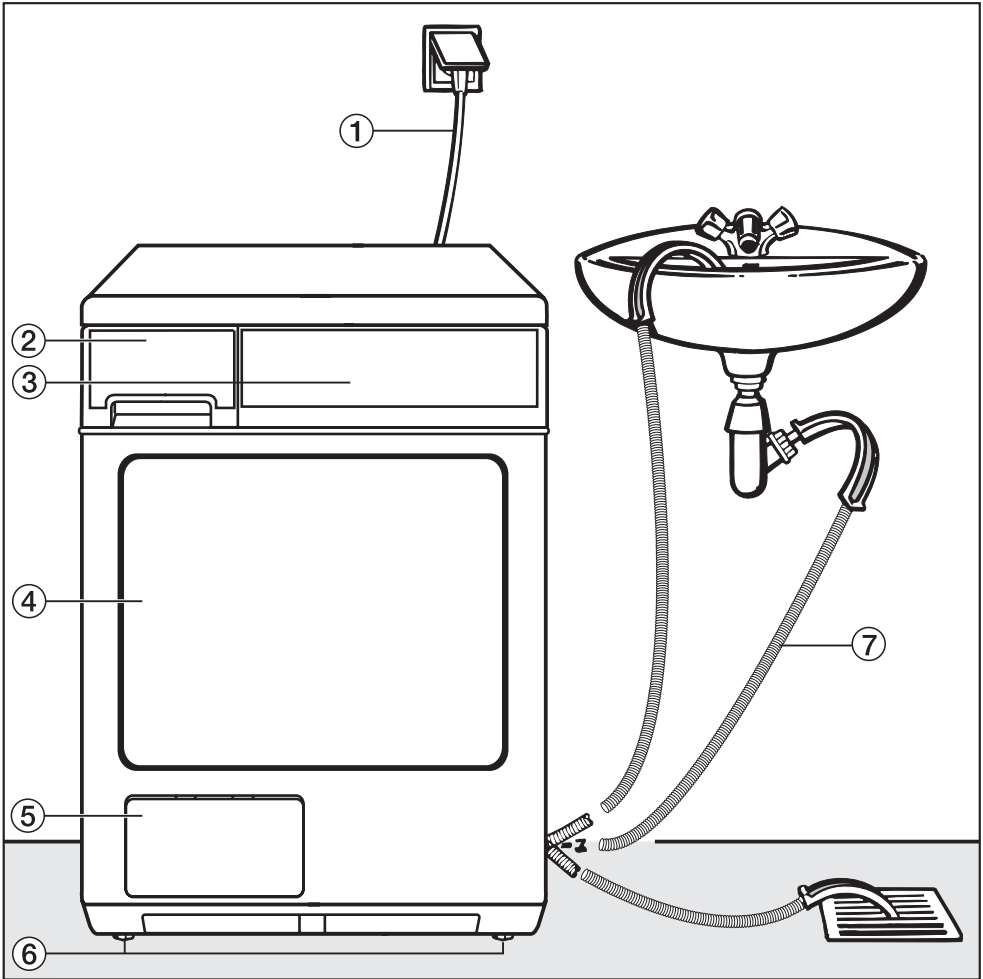

① Power cord with plug

② Condensed water container

③ Control panel

④ Door

⑤ Access panel to condenser

⑥ Four height adjustable feet

⑦ Optional drain hose:

An alternative to using the condensed water container is to drain condensed water into a sink, standpipe or gully.

Installation tips

An airflow gap of $\frac{3}{8}$ " (10 mm) must be provided between the machine and the floor. This airflow gap must not be blocked by a toekick or thick piled carpets.

Do not install the dryer next to a refrigerator. The warm air exhausting from the dryer can affect the thermostat of the refrigerator, causing it to run continuously.

Leveling the dryer

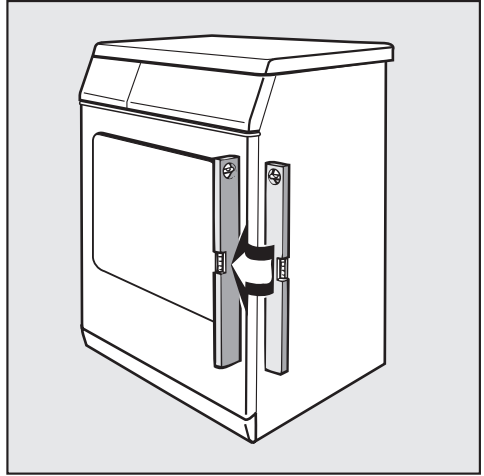

- The dryer must be level to ensure safe and proper operation.

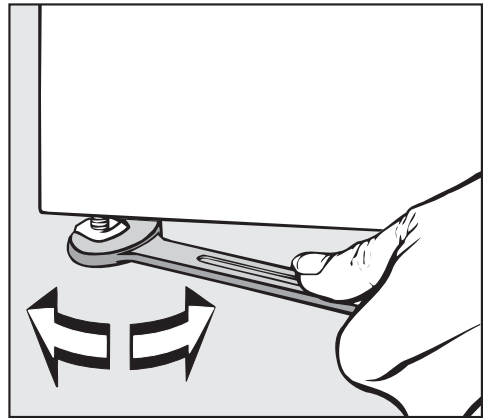

- The machine can be leveled by turning the legs clockwise or counterclockwise as necessary.

Installation

External water drain

When drying is in progress, condensed water is pumped into the condensed water container through the drain hose at the back of the dryer. The condensed water can also be drained directly if the machine is installed near a sink or a stand pipe so that the condensed water container does not have to be emptied.

The drain hose (approx. 6 ft [2 m] long) is stored in the dryer. It must be pulled out of the dryer to its full extent to ensure proper external draining. Maximum delivery head: 4 ft (1.2 m).

If the hose is not long enough, an extension hose is available as an optional accessory from the Miele.

Pulling out the drain hose

Rear dryer top

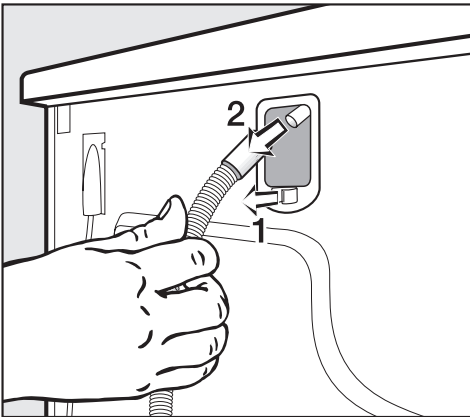

- Unclip the drain hose, **1**, and pull it off the holder **2**.

Rear dryer bottom

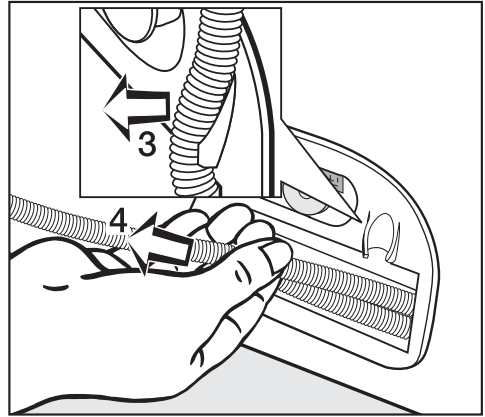

- Unclip the drain hose, **3**.
- Pull the drain hose, to its full extent, out of the dryer towards the left, **4**, (see illustration).

Do not pull or kink the drain hose, it may be damaged!

- Use the curved guide to prevent the drain hose from becoming kinked (see "Front view" illustration).

Draining the condensed water into a sink

- Secure the hose carefully, e.g. by tying the hose to the water tap, to avoid damage by overflowing water.

Connection to a stand pipe

- Insert the drain hose into the Y-adapter of the sink.

If the external drain is no longer used

 Do not push the drain hose back into the dryer. It could become kinked and damage the dryer.

- Loop the drain hose up.
- Use a suitable cable tie to secure the looped hose to the back of the dryer or store the looped hoses behind the dryer.
- Insert the drain hose to the holder and secure it at the rear dryer top (see holder, **2**, "Pulling out the drain hose").

When contacting the Technical Service,
please quote the model and serial number
of your appliance.

The Miele logo is displayed in a bold, white, serif font against a solid black rectangular background.

Miele, Inc. (USA)

National Headquarters

9 Independence Way
Princeton, NJ 08540
Phone: 800-843-7231
609-419-9898
Fax: 609-419-4298
www.mieleusa.com

Technical Service & Support

Nationwide

Phone: 800-999-1360
Fax: 888-586-8056

Miele Limited (CDN)

National Headquarters

55G East Beaver Creek Road
Richmond Hill, ON L4B 1E5
Phone: 800-643-5381
905-707-1171
Fax: 905-707-0177
www.miele.ca
info@miele.ca (general enquiries)
professional@miele.ca (commercial enquiries)

Mielecare National Service

Phone: 800-565-6435
905-850-7456
Fax: 905-850-6651
service@miele.ca (Tech. Service)