

Operating Instructions

Condenser Dryer

T 1570 C

To prevent accidents
and machine damage
read these instructions
before installation or use.

















M.-Nr. 03 719 550

Contents

IMPORTANT SAFETY INSTRUCTIONS	3
Guide to the dryer	5
Before loading the dryer	7
Using the dryer	8
1. Turn on the dryer and load the laundry	8
2. Select a program	9
3. Select the Buzzer to signal the end of the program (if desired)	9
4. Select a lower temperature (if necessary)	9
Programs	10
Using the dryer	11
5. Start the program	11
6. At the end of a program	11
Dryer care	12
Cleaning the lint filter	12
Emptying the condensed water container	13
Cleaning the heat exchanger	14
Changing the light bulb	16
Power failure - Emergency door release	16
Quick Guide	17
Frequently asked questions	17
After Sales service	20
IMPORTANT SAFETY INSTRUCTIONS	22
INSTALLATION INSTRUCTIONS	23
Disposal of the packing materials	23
Disposal of an old appliance	23
Installation	24
Leveling the dryer	24
Installation site	24
Changing the decor panel	25
Fitting a toekick panel	25
Connecting to an external drain	26
Make the electrical connection	28

IMPORTANT SAFETY INSTRUCTIONS

 **WARNING** - To reduce the risk of fire, electric shock, or injury when using your appliance, follow basic precautions, including the following:

-  Read all instructions before using the appliance.
-  Do not dry articles that have been previously cleaned, washed, soaked in, or spotted with gasoline, dry-cleaning solvents, or other flammable or explosive substances. They give off vapors that could ignite or explode.
-  Do not allow children to play on or in the appliance. Close supervision is necessary when the appliance is used near children. Always close the door after use to prevent child hazards.
-  Before this appliance is removed from service or discarded remove the door to the drying compartment.
-  Do not reach into the dryer if the drum is moving.
-  Do not install or store this appliance where it will be exposed to the weather.
-  Do not tamper with the controls.
-  Do not use fabric softener sheets to eliminate static in the dryer. Best results occur when a liquid softener is used in the washing machine.
-  Do not use heat to dry articles containing foam rubber or similarly textured rubber-like materials and items containing, hairspray, nail polish remover or similar substances.
-  Clean the lint filter before or after each load.
-  Keep the area around the air intake (toekick) and adjacent surrounding areas free from lint, dust and dirt.
-  The interior of the machine and exhaust duct should be cleaned periodically by qualified personnel.
-  Do not place items exposed to oils in your dryer. Items contaminated with oils may contribute to a chemical reaction that could cause the laundry to catch fire.

IMPORTANT SAFETY INSTRUCTIONS

■ Do not repair or replace any part of the appliance or attempt any servicing unless specifically recommended in these Operating Instructions. Repairs to electrical appliances should only be performed by qualified personnel. Incorrectly repaired machines may pose a considerable risk to the user.

■ GROUNDING INSTRUCTIONS

■ This appliance must be grounded. In the event of malfunction or breakdown, grounding will reduce the risk of electric shock by providing a path of least resistance for electric current. This appliance is equipped with a cord having an equipment grounding conductor and a grounding plug. The plug must be plugged into an appropriate outlet that is properly installed and grounded in accordance with all local codes and ordinances.

■ **WARNING** – Improper connection of the equipment grounding conductor can result in a risk of electric shock. Check with a qualified electrician or service representative or personnel if you are in doubt as to whether the appliance is properly grounded.

■ Do not modify the plug provided with the appliance: if it will not fit the outlet, have a proper outlet installed by a qualified electrician.

SAVE THESE INSTRUCTIONS

This dryer is intended for residential use only!

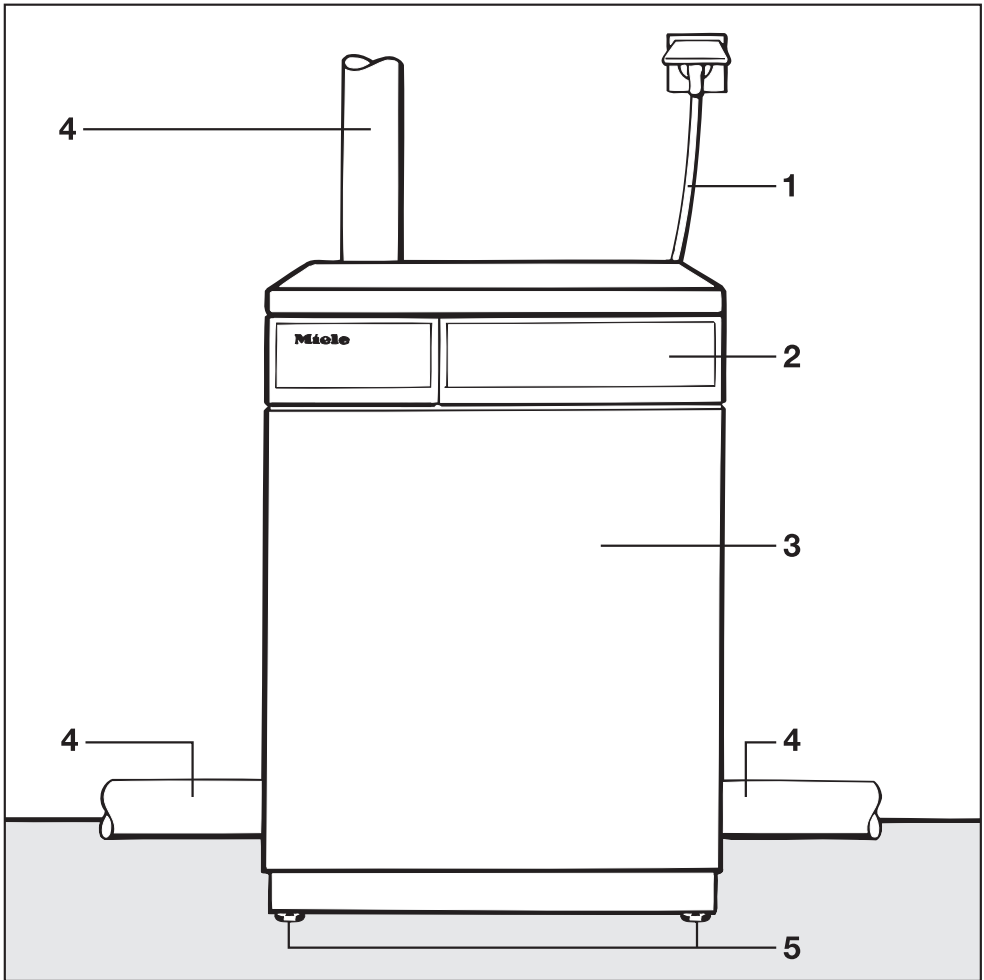

- 1 Supply cable with plug
- 2 Control panel
- 3 Drum door
- 4 Exhaust connection (right, left or rear)
- 5 Four height-adjustable legs

Guide to the dryer

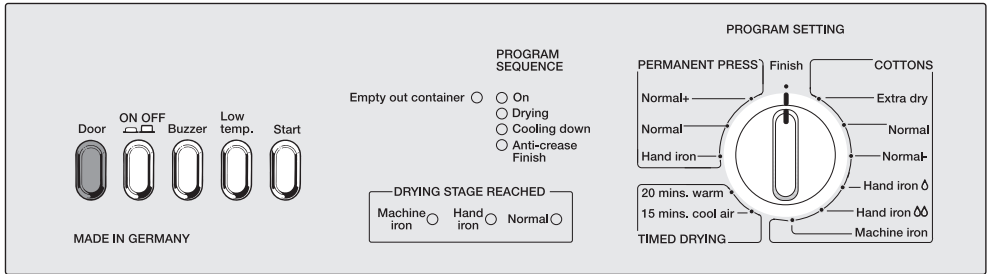

Push buttons

- **Door**
Opens the door or can be used to cancel a program (does not stay pushed in).
- **ON / OFF**
Turns the machine on and off or cancels a program. When the machine is turned on, the “On” indicator will light up if the door is closed. If the door is open the drum light, located inside the machine, will be on.
- **Buzzer**
Allows the buzzer to sound as the drum rotates during the anti-crease cycle.
- **Low temp.**
Lower drying temperatures for delicate fabrics, e.g. acrylics, nylon.
- **Start**
Starts the selected program (it does not stay pushed in).

Indicators

- **Empty out container**
The condensed water container should be emptied.
- **PROGRAM SEQUENCE**
The program sequence indicator lamps show the current status of the drying program.
- **DRYING STAGE REACHED**
These indicator lamps show which drying stage the program has reached. For program stages “Normal” and “Extra dry” the indicator lamp remains at the “Normal” position.

PROGRAM SETTING

Set the desired program by turning the knob either clockwise or counterclockwise.



- **COTTONS**
- **PERMANENT PRESS**
- **TIMED DRYING**
Items can be either dried for 20 minutes (incl. a cooling-down phase) or cool air fluffed for 15 minutes.

Before loading the dryer

The appliance must be correctly installed and connected before the first use. Please see the "Installation instructions".

- Check the dryer drum for any residue that may have deposited during the manufacturing process. If necessary clean out with a cloth.

Before drying, check fabric care labels for special drying instructions.

-  = Dry with normal temperature
-  = Dry with low temperature (select "Low temp." option)
-  = do not dry in tumble dryer

If no symbol is present:

Dry **cottons and permanent press laundry** in their corresponding programs.

Dry **delicate fabrics like polyester**, in one of the "PERMANENT PRESS" programs.

Wool, wool blends, linen and down filled items should not be machine dried.

Drying tips

Knitted fabrics and flannel tend to shrink when washed and dried for the first time. Do not over dry these fabrics.

Permanent press and delicate fabrics tend to crease.

For better drying results reduce the load size and select the "PERMANENT PRESS/Hand iron" program.

To prevent discoloration, do not dry **new dark-colored fabrics** with light-colored items.

Do not overload the drum!

Overloading the dryer will result in poor drying and wrinkling.

Close zippers and tie up fabric belts and apron ties.

Do not dry items that may melt or ignite in the dryer such as plastics, rubber or sneakers.

Using the dryer

1. Turn on the dryer and load the laundry

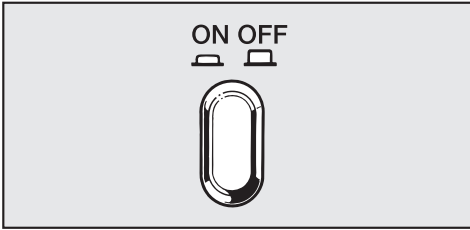

- Press the "On/Off" button to turn on the dryer.



- Press the "Door" button to open the door.
- Load the laundry loosely into the drum.
- Close the door with a firm swing - do not push it shut.

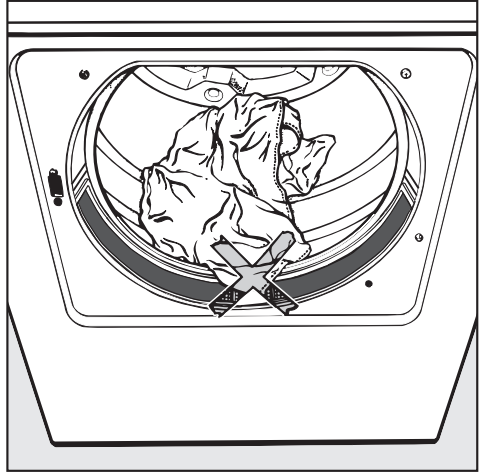

To prevent fabric damage, check that laundry will not be caught in the closed door.

Do not use fabric softener sheets in this dryer. Silicates contained in these sheets could cause the dryer to overheat.

2. Select a program

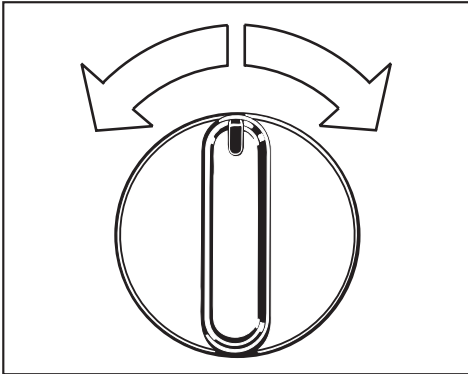

- Turn the program selector clockwise or counterclockwise to the desired program.

Please refer to the "Programs" chart.

The program status will be stored for 30 minutes in the event of a power failure.

3. Select the Buzzer to signal the end of the program (if desired)

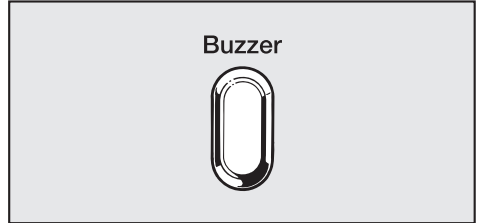

- Press the "Buzzer" button.

4. Select a lower temperature (if necessary)

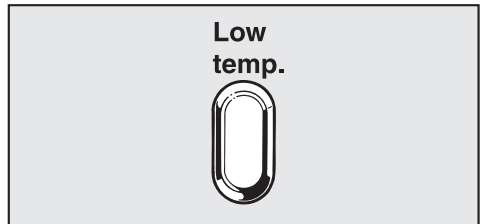

- Press the "Low temp." button to reduce the temperature when drying delicate fabrics.

Programs

Program	Fabric	Note
COTTONS		
Extra dry	For drying laundry that will be stored away, such as linens or seasonal clothing.	The "Extra dry" program should not be selected for jersey materials. Items may shrink.
Normal	Uniform loads of cotton e.g. sheets, underwear, socks.	–
Normal-	Knitted cotton fabrics that may shrink, e.g. jersey material or lightweight cottons.	If items are still damp, redry using "Normal+".
Hand iron Δ	Cotton or linen fabrics to be left damp for easier ironing.	–
Hand iron $\Delta\Delta$		If fabrics are too damp for ironing, redry using "Hand iron Δ ".
Machine iron	Cotton or linen fabrics, which will be ironed with a rotary iron.	To prevent moisture loss, roll up the laundry until ironing.
PERMANENT PRESS		
Normal+	Permanent press items.	
Normal	Permanent press and blended fabrics made of blended woven or knitted fabrics, e.g. cotton/synthetic.	
Hand iron	Permanent press and blended fabrics, requiring an ironed finish.	Reduce load size for fabrics that wrinkle easily.
TIMED DRYING		
20 mins. warm	Individual items or very small loads.	–
15 mins. cool air	Individual items to be freshened and fluffed with cool air.	–

5. Start the program

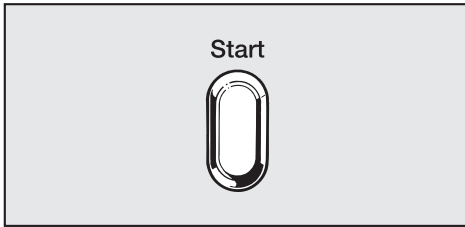

- Press the "START" button.

6. At the end of a program

The "Anti-crease/Finish" indicator will light at the end of a program.

- Turn the program selector to "Finish".

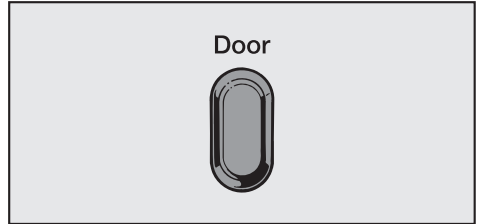

- Press the "Door" button to open the door.
- Remove the laundry.
- Check that the drum is empty.
- Clean the lint filter before or after each use (see "Cleaning the lint filter".)



- Press the "On/Off" button to turn off the dryer.

Dryer care

Cleaning the lint filter

The lint filter must be cleaned before or after every program.

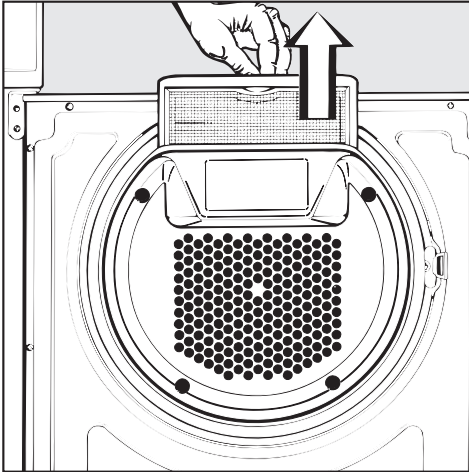

- Open the door and remove the lint filter.
- Wipe the lint off the filter with your hand, do not use any sharp objects!
- Any lint remaining in the hollow part of the door can be removed through the gap at the bottom with a dust brush or vacuum.
- Return the lint filter and close the door.

The lint filter can be rinsed with hot water if necessary.

- Dry the lint filter before putting it back in place.

Before cleaning the tumble dryer, disconnect the machine from the power supply. Never use abrasive cleaners, scouring pads, steel wool or caustic (oven) cleaners on the dryer. They will damage the surface.

Cleaning the exterior and the control panel

- The exterior and the control panel can be cleaned with warm water and liquid dish soap applied with a soft sponge.
- Wipe dry using a soft cloth.

Cleaning the drum and stainless steel parts

- Stainless steel surfaces can be cleaned using a non-abrasive stainless steel cleaner.
- Wipe dry using a soft cloth.

Emptying the condensed water container

Depending on your type of installation, the condensed water will either be pumped to a drain, or collected in the condensed water container, located in the upper left corner of the machine. The container holds approximately 1 gallon of water.

The container should be emptied weekly.

Should the container be full when the tumble dryer is started, or if it becomes full during normal operation:

- The “Empty out container” indicator will light.
- The buzzer will sound.
- The drying program will stop.
- The machine will enter the cooling down cycle.

To empty the container

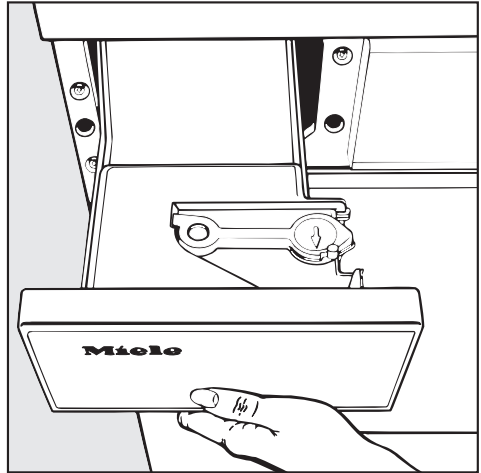

- Pull out the container with both hands.

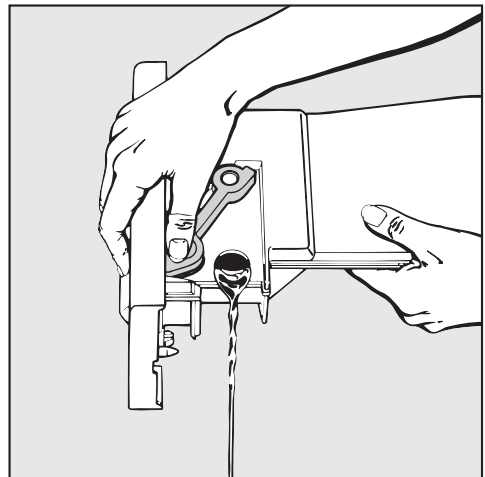

- Hold the cap open while emptying the container.
- When the container is empty, push it into its recess until it clicks into place.

Do not drink the condensed water.

Dryer care

Cleaning the heat exchanger

Disconnect the machine from the power supply.

- The heat exchanger should be cleaned every 6 months.
- Open the door.

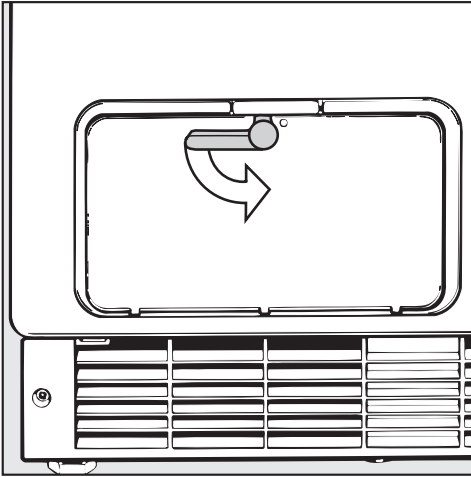

- Turn the lever so that it is vertical.

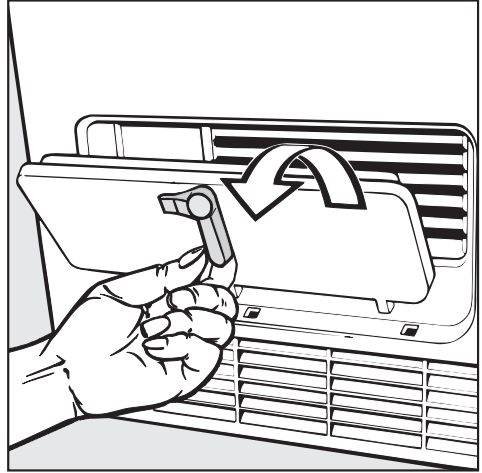

- Remove the cover.

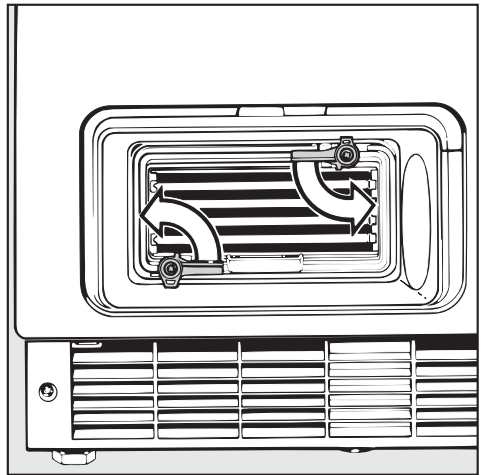

- Turn both levers, on the heat exchanger, so that they are vertical.

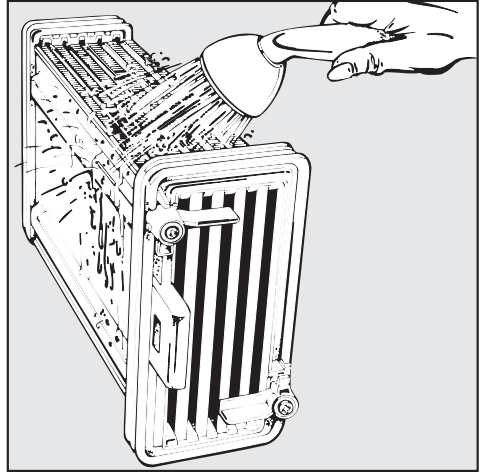
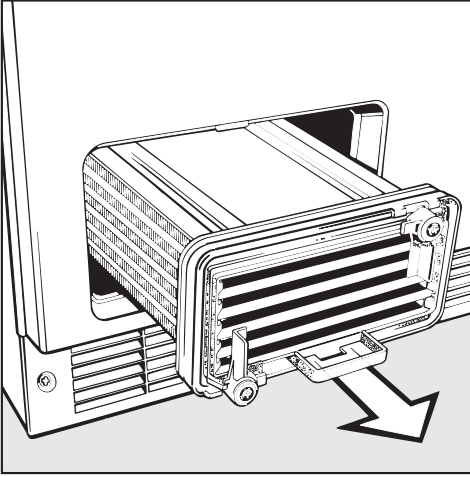

- Pull out the heat exchanger.
- Clean the heat exchanger:

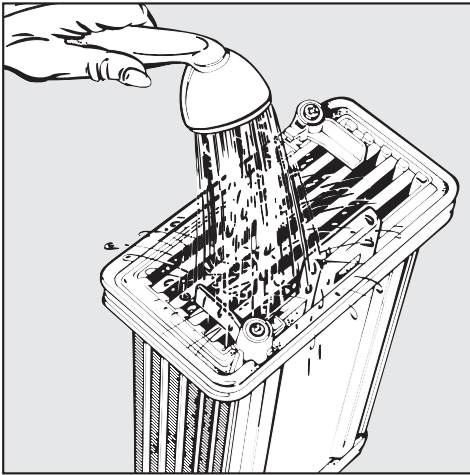

- and along the two long sides
- Stand the heat exchanger lengthwise on a towel until it dries.
- Replace the heat exchanger in the reverse order.
- Make certain the heat exchanger is pushed in all the way and that the cover is firmly closed. Otherwise water may leak from the machine.

- at both ends (front and back)

Dryer care

Changing the light bulb

WARNING

To reduce the risk of electric shock, disconnect this appliance from the power supply by unplugging or tripping the circuit breaker.

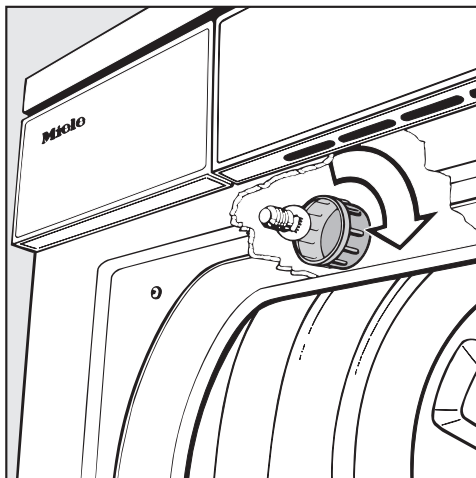

- Unscrew the plastic bulb cover located inside the drum and above the door (see illustration.)
- Replace the light bulb with a temperature proof bulb (part # 02 150 900) available from Miele's Technical Service Department.

The light bulb must not exceed the maximum wattage quoted on the data plate.

- Refit the plastic bulb cover.

Take care that the bulb cover is tightened into place. Otherwise moisture may penetrate the socket and cause a short circuit.

Power failure - Emergency door release

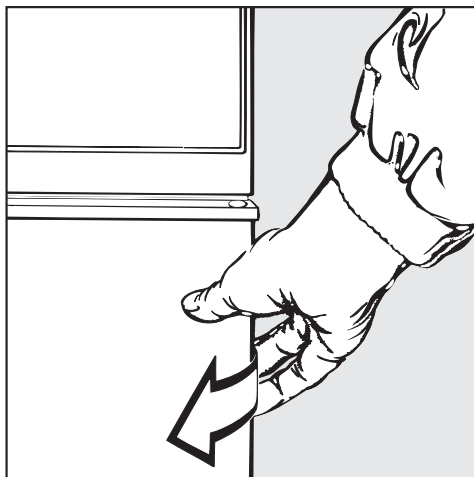

- Pull forward on the unHINGED side of the door.

Quick Guide

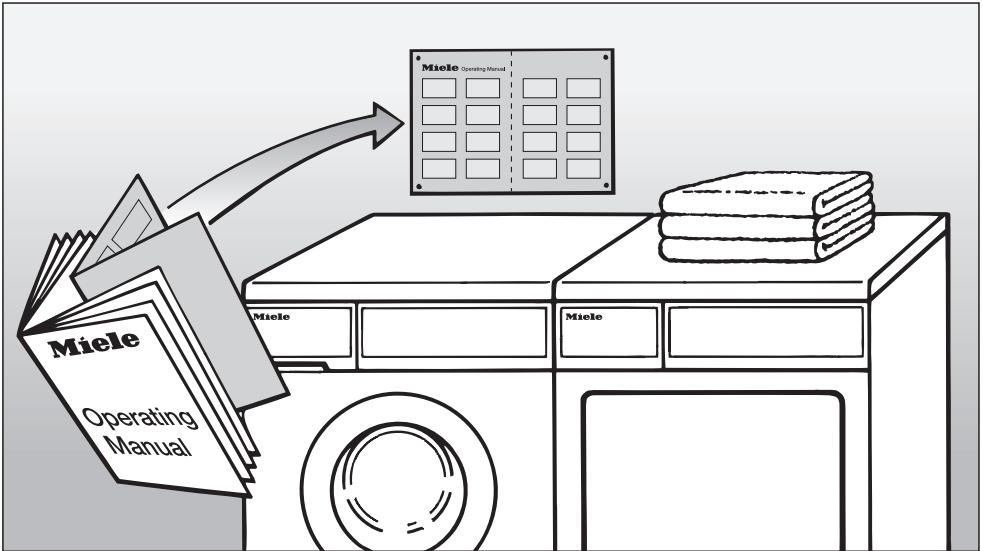

Remove this guide for easy reference

Please read all instructions, especially the "Important Safety Instructions", **before** using the dryer.

Quick Guide

1. Turn on the dryer and load the laundry

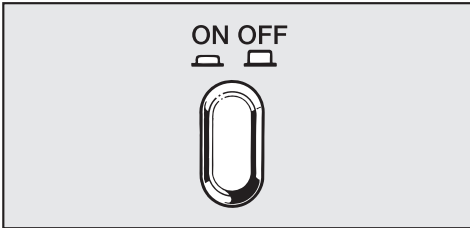

- Press the "On/Off" button to turn on the dryer.



- Press the "Door" button to open the door.
- Load the laundry into the drum. Make sure that there is enough space in the drum for clothes to tumble freely.

To prevent fabric damage, check that laundry will not be caught in the closed door.

- Close the door with a firm swing - do not push it shut.

2. Select a program

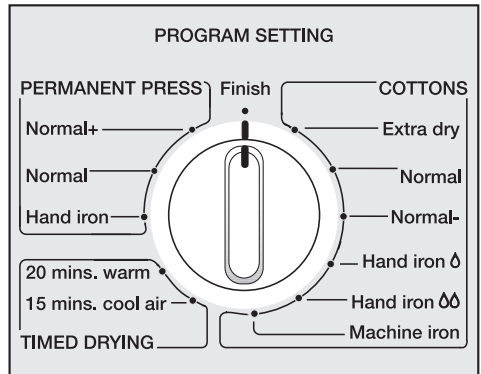

- Turn the program selector clockwise or counterclockwise to the desired program.

3. Select the Buzzer to signal the end of the program (if desired)

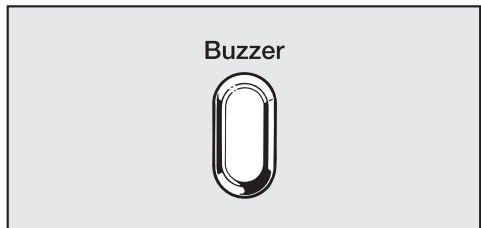

- Press the "Buzzer" button.

4. Select a lower temperature (if necessary)

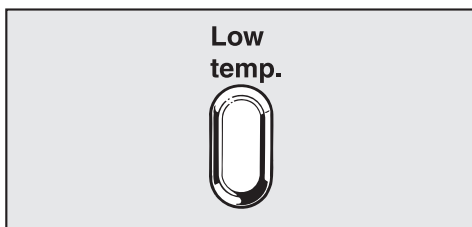

- Press the "Low temp." button to reduce the temperature when drying delicate fabrics.

5. Start the program

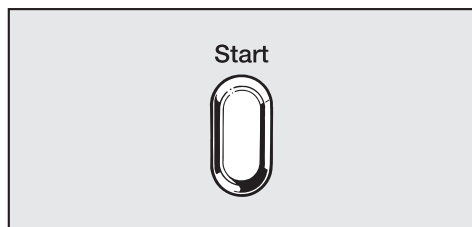

- Press "START".

6. At the end of a program

The "Anti-crease / Finish" indicator will light.

- Turn the program selector to "Finish".



- Press "Door" and remove the laundry.

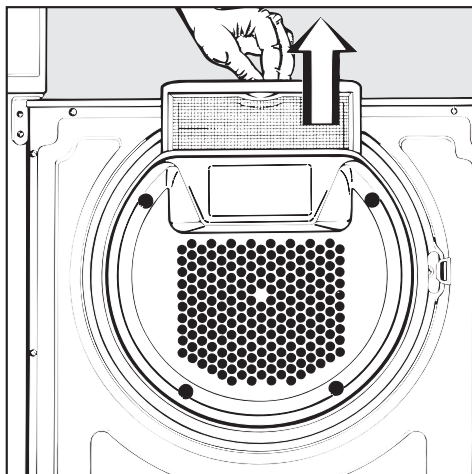

- Clean the lint filter.

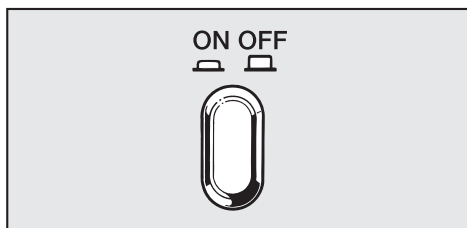

- Press the "On/Off" button to turn off the dryer.

Quick Guide

Program	Fabric	Note
COTTONS		
Extra dry	For drying laundry that will be stored away, such as linens or seasonal clothing.	The "Extra dry" program should not be selected for jersey materials. Items may shrink.
Normal	Uniform loads of cotton e.g. sheets, underwear, socks.	–
Normal-	Knitted cotton fabrics that may shrink, e.g. jersey material or lightweight cottons.	If items are still damp, redry using "Normal+".
Hand iron Δ	Cotton or linen fabrics to be left damp for easier ironing.	–
Hand iron $\Delta\Delta$		If fabrics are too damp for ironing, redry using "Hand iron Δ ".
Machine iron	Cotton or linen fabrics, which will be ironed with a rotary iron.	To prevent moisture loss, roll up the laundry until ironing.
PERMANENT PRESS		
Normal+	Permanent press items.	
Normal	Permanent press and blended fabrics made of blended woven or knitted fabrics, e.g. cotton/synthetic.	
Hand iron	Permanent press and blended fabrics, requiring an ironed finish.	Reduce load size for fabrics that wrinkle easily.
TIMED DRYING		
20 mins. warm	Individual items or very small loads.	–
15 mins. cool air	Individual items to be freshened and fluffed with cool air.	–

Frequently asked questions

With the following guide, minor problems can be fixed without a service call.

What if	Possible fault	Fix
... the tumble dryer fails to start when turned on?	Check whether the "On" indicator lights up. If so, failure to start may be due to an incorrect program selection procedure.	Repeat the program selection procedure in the correct sequence, see "Using the dryer".
	If the "On" indicator lamp does not illuminate, check that:	<ul style="list-style-type: none"> – The "ON/OFF" button is pressed in. – The door is properly closed. – The machine is plugged in and the fuse or circuit breaker has not tripped.
... the laundry is not dry enough?	The load consisted of dissimilar items (size and fabrics).	Select a longer drying program.
	Small loads or individual items may cause the program to terminate prematurely.	Use a timed drying program.
	The load was too large for the "Load size - Half" position.	Press the "Load size - Full" button when drying larger loads.
... the drying times are too long?	The lint filter is clogged.	Clean the lint filter in the door.
	The laundry was not spun in the washer for a sufficient time.	Make sure that the laundry is thoroughly spun before drying.

Frequently asked questions

What if, . . . ?	Possible fault	Fix
<p>. . . the "anti-crease" indicator lamp in the sequence indicator display starts flashing?</p>		<ul style="list-style-type: none"> – Turn the program selector to "finish". – Turn the machine off and then on again. – Select a program.. – Press the "Start" button. <p>If the indicator lamp starts flashing again, this indicates a fault in the machine. Please contact the Miele Service Dept.</p>
<p>. . . the drum door opens during the drying cycle?</p>	<p>The machine has overheated. The temperature limiter opened the drum door and caused the machine to turn off automatically. Possible reasons for overheating:</p> <ul style="list-style-type: none"> – The lint filter in the door is clogged. – The vent duct is blocked. – The vent aperture (e.g. louvered window vent, wall vent) is blocked. 	<p>Before restarting the program, proceed as follows:</p> <ul style="list-style-type: none"> – Release the ON/OFF button. – Clean the affected part of the machine. – Turn on the machine again. – Reselect the terminated program. – Press the "Start" button. <p>If the drum door opens again, the Miele Service Dept. should be contacted.</p>

Frequently asked questions

What to do if, . . . ?	Cause . . .	Remedy . . .
<p>. . . drops of water appear along the upper edge of the drum door?</p>	<p>This may not be a problem. A dual filter system with two seals is used to prevent lint from becoming deposited in the heat exchanger.</p>	<p>These two seals may occasionally cause condensed water to form on the door. Laundry coming into contact with these drops of water will dry within a few minutes.</p>
<p>. . . after cleaning the heat exchanger, water leaks from the machine?</p>		<p>Check that the heat exchanger door has been replaced correctly. If necessary, remove and replace it.</p>
<p>. . . the interior drum light fails to function?</p>		<p>See "Changing the light bulb".</p>
<p>. . . you have to open the door in the event of a power failure?</p>		<p>See "Power failure – Emergency door release".</p>

After Sales service

In the event of a problem which you cannot fix yourself, or to order spare parts please contact:

– Your Miele Dealer

or

– The Miele Technical Service
Department

USA 1-800-999-1360
techserv@mieleusa.com

CDN 1-800-565-6435
service@miele.ca

When contacting the Technical Service Department, please quote the model and serial number of your appliance. They can be found on the data plate located below the drum opening.

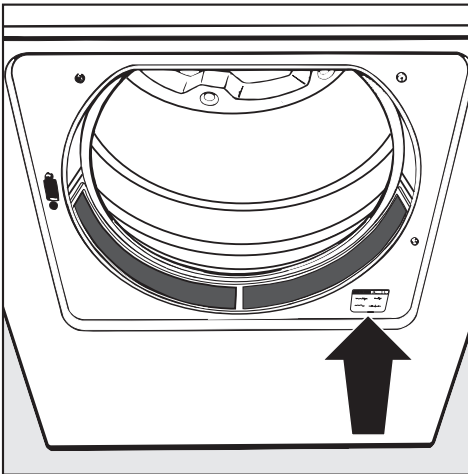



Installation Instructions

To prevent accidents
and machine damage
read these instructions
before
installation or use.

IMPORTANT SAFETY INSTRUCTIONS

■ Installation, repair and maintenance work should be performed by a Miele authorized service technician. Work by unqualified persons could be dangerous and could void the warranty.

■ Before installation, disconnect the tumble dryer from the electrical supply by unplugging the power cord or tripping the circuit breaker.

GROUNDING INSTRUCTIONS

■ This appliance must be grounded. In the event of malfunction or breakdown, grounding will reduce the risk of electric shock by providing a path of least resistance for electric current. This appliance is equipped with a cord having an equipment-grounding conductor and a grounding plug. The plug must be plugged into an appropriate outlet that is properly installed and grounded in accordance with all local codes and ordinances.

■ **WARNING** – Improper connection of the equipment-grounding conductor can result in a risk of electric shock. Check with a qualified electrician or service representative or personnel if you are in doubt as to whether the appliance is properly grounded.

■ Do not modify the plug provided with the appliance: if it will not fit the outlet, have a proper outlet installed by a qualified electrician.

■ If there is any doubt concerning installation contact Miele's Technical Service Department.

USA 1-800-999-1360
techserv@mieleusa.com

CDN 1-800-565-6435
service@miele.ca

Disposal of the packing materials

The cardboard box and packing materials protect the appliance during shipping. They have been designed to be biodegradable and recyclable.

To prevent suffocation ensure that any plastic wrappings, bags etc. are disposed of safely and kept out of the reach of children.

Please recycle.

Disposal of an old appliance

Old appliances may contain materials that can be recycled. Please contact your local recycling authority about the possibility of recycling these materials.

Ensure that the appliance presents no danger to children while being stored for disposal. Before discarding an old appliance, unplug it from the outlet and cut off its power cord and remove any doors to prevent hazards.

Installation

Leveling the dryer

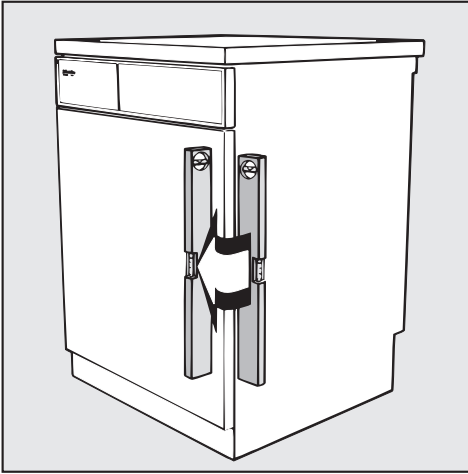

The machine should be perfectly level to ensure safe and proper operation. Minor discrepancies do not, however, have an adverse effect on operation.

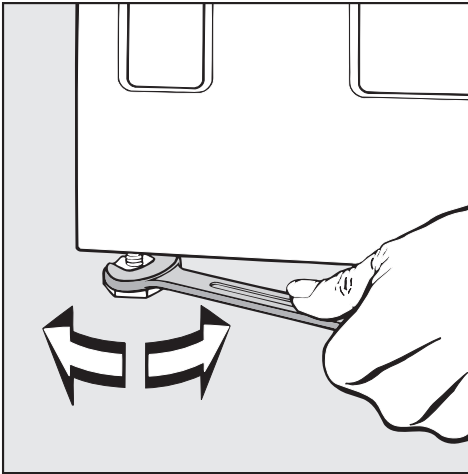

- The machine can be leveled by turning the legs clockwise or counterclockwise as necessary.

Installation site

An air flow gap of $\frac{3}{8}$ " (10 mm) must be provided between the machine and the floor. This air flow gap must not be blocked by a toekick or thick-piled carpets.

It is possible to install this appliance under a continuous countertop. The machine lid can be removed, if necessary.

The tumble dryer can also be placed on top of a Miele washing machine for a stacked installation. An appropriate stacking kit is required.

The stacking kit, part # 12 996 026, is available from your Miele dealer or the Miele Technical Service Department.

Changing the decor panel

Note: The door should be closed when installing the decor panel.

- On the door lock side remove the 4 screws (3 on the side and 1 underneath) and the door strip.
- Loosen the remaining 7 screws on the lower and side decor strips until the decor panel can be bowed slightly and taken out.
- Insert the new panel.
- Reassemble in the reverse order and tighten the screws.

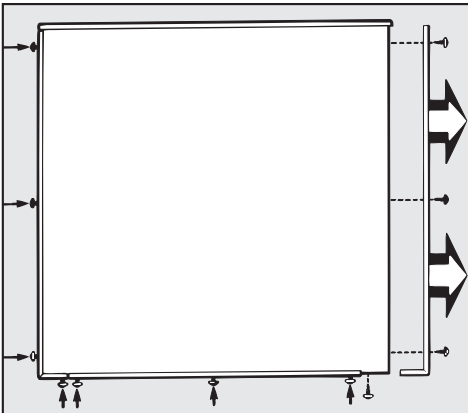

Decor panel dimensions

Width: $23 \frac{11}{16}$

Height: $23 \frac{1}{8}$

Thickness: $\frac{1}{16}$

Panels between $\frac{1}{16}$ and $\frac{1}{8}$ thick require an adapter strip available from the Technical Service Department.

Fitting a toekick panel

The appliance toekick below the door can be concealed using a toekick panel.

The height and depth of the appliance toekick cannot be altered.

A cut-out must be made in the toekick panel around the ventilation slots. If the ventilation slots are blocked the machine will not dry efficiently.

Installation

Connecting to an external drain

The condensed water can be sent directly to a drain if the machine is installed near a sink or standpipe. The machine is equipped with a non-return valve that will prevent water from flowing back into the machine if there is a problem in the drainage system.

Max. drain hose length: 10 ft
Max. drain height: 4 ft.

Supplied accessories:

- 6 ft drain hose
- Hose clamp
- Hose elbow

To make a direct drain connection, proceed as follows:

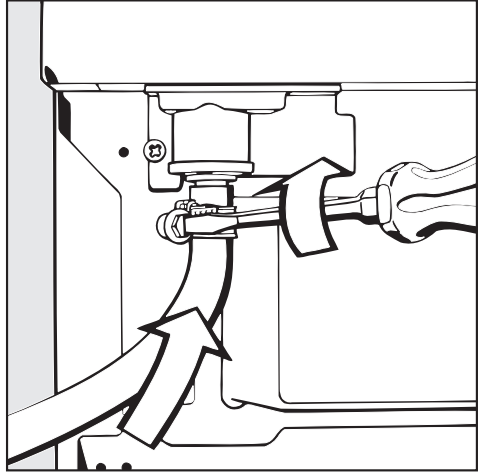

- Remove the clamp from the plug and place it over the drain hose.
- Push the drain hose onto the drain outlet. Make sure that the hose is not kinked and firmly secured by the hose clamp.

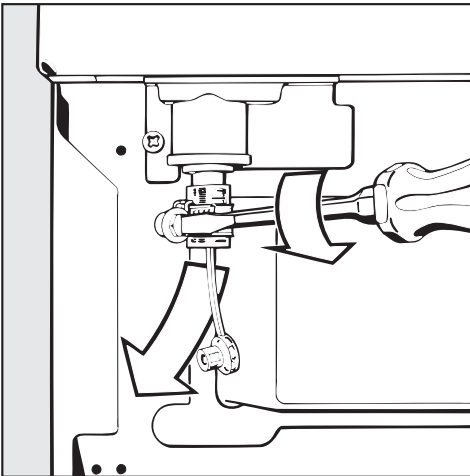

- Loosen the hose clamp at the drain outlet at the rear lower left of the machine and remove the rubber plug.

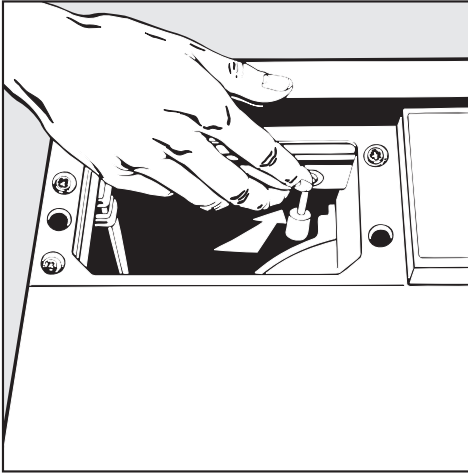

- Close the water inlet port above the condensed water container with the bottom part of the rubber plug. The plug must face towards the interior of the machine so that the condensed water container can be easily inserted.
- Attach the elbow to the hose and secure it to the sink or into the drain pipe. If room is available, it can be inserted into the stand pipe used by the washing machine.

The water will now be drained automatically and the container will not need to be emptied.

Installation

Make the electrical connection

GROUNDING INSTRUCTIONS

This appliance must be grounded. In the event of malfunction or breakdown, grounding will reduce the risk of electric shock by providing a path of least resistance for electric current. This appliance is equipped with a cord having an equipment grounding conductor and a grounding plug. The plug must be plugged into an appropriate outlet that is properly installed and grounded in accordance with all local codes and ordinances.

WARNING – Improper connection of the equipment grounding conductor can result in a risk of electric shock. Check with a qualified electrician or service representative or personnel if you are in doubt as to whether the appliance is properly grounded.

Do not modify the plug provided with the appliance: if it will not fit the outlet, have a proper outlet installed by a qualified electrician.

Electrical connection

The dryer comes with a 5 ft long, 12/4 AWG cord and a NEMA 14-30 P plug.

It should be connected to a 120/208-240 V, 15 A, 60 Hz AC power supply. A 3 pole-4 wire grounding power outlet (NEMA type 14-30 R) is necessary.

EASY INSTALLATION KIT

If you do not have a dedicated 15 Amp line for this appliance, but you have the standard, 120/208-240 V - 30 Amp, 60 Hz AC outlet, you can use the "Easy Installation Kit", which allows you to use that line to connect this appliance.

057B for on-site outlet NEMA 10-30 R
060B for on-site outlet NEMA 14-30 R

For more information on the "Easy Installation Kit" or if you have questions concerning the electrical connection please contact:

USA 1-800-999-1360
techserv@mieleusa.com

CDN 1-800-565-6435
service@miele.ca

**When contacting the Technical Service,
please quote the model and serial number
of your appliance.**



Miele, Inc. (USA)

National Headquarters

9 Independence Way

Princeton, NJ 08540

Phone: 800-843-7231

609-419-9898

Fax: 609-419-4298

www.miele.com

**Technical Service & Support
Nationwide**

Phone: 800-999-1360

Fax: 888-586-8056

Miele Limited (CDN)

Headquarters and Showroom

161 Four Valley Drive

Vaughan, ON L4K 4V8

Phone: 800-643-5381

905-660-9936

Fax: 905-532-2290

www.miele.ca

info@miele.ca (general enquiries)

professional@miele.ca (commercial enquiries)

MieleCare National Service

Phone: 800-565-6435

905-532-2272

Fax: 905-532-2292

service@miele.ca (technical enquiries)